



RainPoint[®] Smart
More Than Water Saving

USER MANUAL

1-Zone Smart Hose Timer

Model No. HTV107B

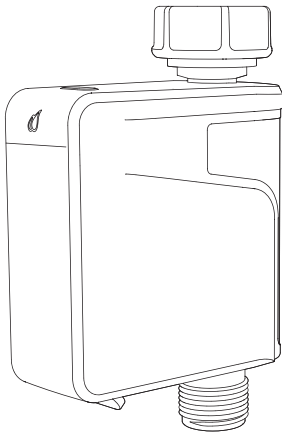

Welcome to the **RAINPOINT** family! Please read the manual before using to learn about the features and functions.

Contents

1. Contents in the box	01
2. Introduction	02
2.1 Product Overview	02
2.2 Specification	02
2.3 Features	03
3. Connection and Installation	03
3.1 APP Download	03
3.2 Connect the Bluetooth Water Timer	05
3.3 Timer Installation	10
3.4 Test Before Use	12
4. App Features and Functions	13
4.1 APP Home Screen	13
4.2 Device Home Page	14
4.3 Basic Setting	16
4.4 Plan Setting	18
4.5 Manual Watering	22
4.6 Weather Conditions & Devices' Next Plan Time	24
4.7 Plan Overview & Setting	25
4.8 Home Management	26
4.9 Third-Party Voice Service	27
4.10 Reset The Device	28
4.11 The Meaning Of Led Light	28
5. Troubleshooting	29
6. Precautions	31
7. Warranty Policy	32
8. FCC Statement	33
9. Customer Support	34

1. Contents in the box

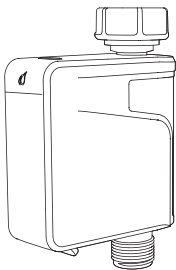

1



3



4

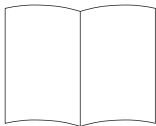

2

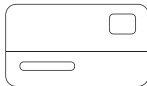

5

1. 1 x HTV107B 1-Zone Smart Hose Timer
2. 1 x User Manual
3. 1 x Sealing Tap
4. 1 x Quick Setup Guide
5. 1 x Warranty Card

2. Introduction

2.1 Product Overview

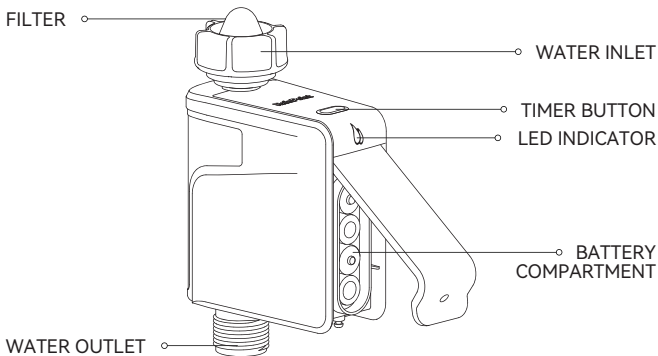

2.2 Specification

- 1" or 3/4" inlet thread and 3/4" outlet thread.
- **Operating Water Pressure:** 0.5~8 bar (7- 116 PSI).
- 1 min ~ 12 hrs.
- **Waterproof Level:** IP54.
- Maximum 6 plans per zone.
- **Working Temperature:** 37°F~ 122°F (3°C~50°C).
- Communicated by Bluetooth 5.0.
- Up to 60m depending on obstacles between hub and timer.
- Powered by 4* AA batteries (not included).

2.3 Features

- Remote controlled via Bluetooth.
- Review timer action events on the APP.
- Two different watering modes: Irrigation Mode or Interval Mode.
- Up to six individual watering plans can be scheduled.
- Can pair with smart hub (not included).

3. Connection And Installation



Tips: Please scan the QR code or search the link for setup video or customer support to install the device quickly.

Setup Video: www.youtube.com/@rainpoint

3.1 APP Download

- a. Search and download **RainPoint Smart+** on:



b. Or scan the QR code to download:



iOS



Android

c. **Create an account and log in:**

Follow the prompts to register an account with your email or mobile phone.

A screenshot of a mobile application's login screen. At the top, the word "Welcome" is displayed in a large, bold, black font. Below it, "RainPoint-Smart" is written in a smaller, grey font. A dropdown menu shows "China +86" with a right-pointing arrow. Below that are two input fields: "Email or mobile number" with a person icon and "Password" with a key icon. At the bottom of the password field is a "Forgot Password" link. Below the input fields are two links: "Register" and "Forgot Password". A large, rounded green button with the text "Log In" is centered below the links. At the bottom, there is a green checkmark icon followed by the text "I Agree User Agreement and Privacy Policy" and a "Quick Guide" link below it.

3.2 Connect the Bluetooth Water Timer

1. Insert **4 new AA alkaline batteries** (not included) into the battery compartment of the timer. Restore the battery compartment and make certain it is secured.

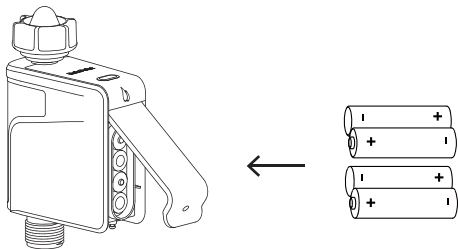

WARNING:

- Please use only alkaline batteries.
- Do not mix old and new batteries.
- Batteries are to be inserted with the correct polarity.
- Exhausted batteries are to be removed from the product.
- Please remove the battery from long-term no use.

3. Press and hold the button of the timer until **the light flashes red quickly**. Meanwhile, select **"Next"** on the APP and it will start searching the device automatically.



NOTE: Before adding the water timer, please turn on the Bluetooth of your phone for pairing, and turn off the Bluetooth after the pairing is successful. In addition, please keep your phone close to the water timer when connecting with Bluetooth for faster pairing.

4. If you fail to connect the timer for the first time, you can hold the button on the timer(or refer to **RESET THE DEVICE** in the manual) to reset and reconnect it.
5. After successfully connecting and creating plans, the next watering plan time will be displayed on the device page.
6. After the connection is successful, the icon of the water timer will be displayed on the APP home screen.

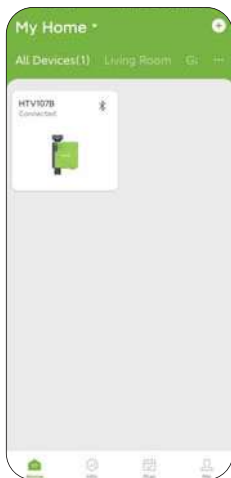
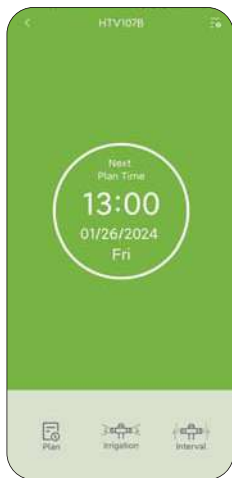

TIPS: How to change from Bluetooth connection to WiFi remote connection?

If you have connected the **HWG009WB Smart Hub** (not included), **please add this Bluetooth Water timer to the hub**, so that you can achieve WiFi wireless remote connection without being limited by the Bluetooth connection distance.

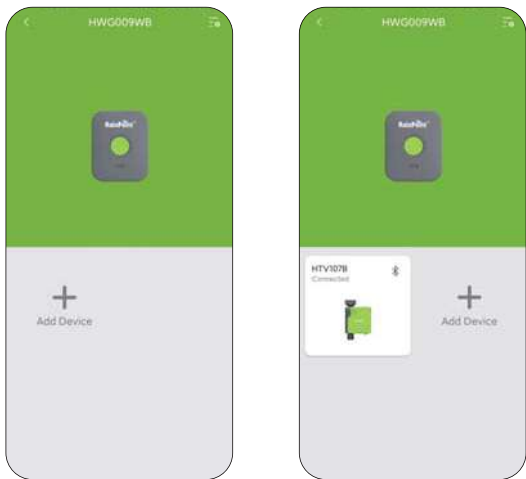

NOTE: When you add the timer to the smart hub, it becomes a remote control timer.

3.3 Timer Installation

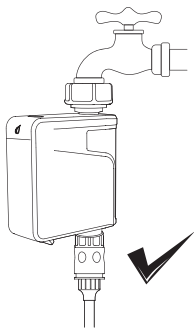

1. Turn off the garden faucet.
2. Wrap Teflon Tape around the faucet thread.
3. Screw the timer to the garden faucet and make it as vertical as possible to the ground (as shown below) to prevent rainwater from accumulating and leaking into the interior.
4. Wrap Teflon Tape around the thread of the timer outlet.
5. Screw the garden hose to the timer outlet.
6. Turn on the faucet after programming the timer.

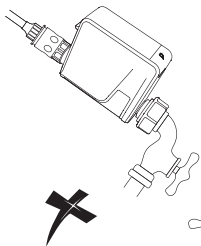
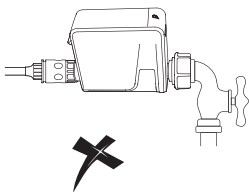

Less than 200 feet
(No bushes, walls blocking)

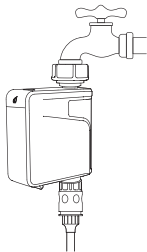

Tips: If the connection between the timer and the faucet or hose is not tight or is leaking, wrap more Sealing Sap (thread seal tape) around them to secure the connection.

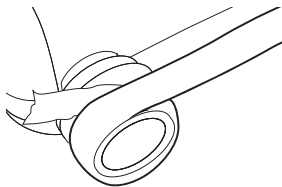

Please install the filter correctly (as shown left) and keep it clean to achieve a better filtering effect.

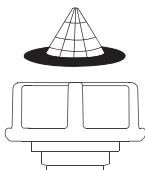

WARNING: Please make sure the smart phone is near the Bluetooth water timer when connecting or setting the watering plan. The best range for connection and operation is within 60 meters in the open area. If there are walls, iron gates or bushes blocking, please shorten the distance between them to better receive the signal.

3.4 Test Before Use

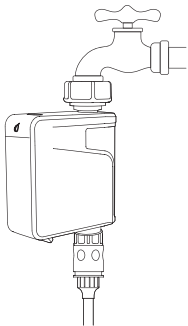

Congratulations, you have completed the connection and installation of the Bluetooth Water Timer. Please test whether the internal valve of your water timer is normal before using it.

1. Keep the faucet turned off.
2. Press the button of the timer, with a "click" sound, the valve inside the timer opens for manual watering. After a few seconds, press the button again, the "click" will sound again, and the valve will close.
3. Turn on the faucet a little bit, and press the button on the timer to check if the water flows out or shuts off as expected. If yes, the valve is normal, please use it with confidence! If not, please repeat the above steps several times.

The test is over, everything is normal, please keep the faucet fully turned on!

Note: When testing, please keep away from the water outlet of the timer to avoid being splashed and wet.

The valve is usually activated, but external factors such as force or environmental conditions during storage and transportation may cause the valve to be protectively closed. In such cases, you need to activate the timer valve manually.

4. APP Features And Functions

4.1 APP Home Screen

All Devices

A check list of all the devices you have connected. Tap the icons to enter the operation page of devices you have added to program the operation schedule of the device.

Room Management

Room Management is for indoor automatic irrigation system in different room.

Plan

On the "Plan" screen, you can view, customize, and turn on or off the watering schedules for the water timer. You can also turn on or off the "Rain Delay" function for rainy days and choose its duration from 24, 48, or 72 hours.

Info

On the "Info" screen, you can check the weather conditions for the next seven days in your area and the next plan time of the devices you have connected.



Home Management

You can locate your home, customize the home name and add family members or add other homes. It is convenient for you to manage irrigation schedules for different residences.

Add Devices

You can add multiple RainPoint devices on the APP to create a smart home irrigation system.

Me

On the "Me" screen, you will receive notifications for device online/offline status, irrigation records, and alerts for high temperature under "Event". Get FAQs and user manuals, as well as report issues through "Help & Feedback". Connect the water timer to your Google Assistant or Amazon Alexa for voice control of the valve. Adjust language preferences and turn on/off notifications in the "Settings" menu.

4.2 Device Home Page

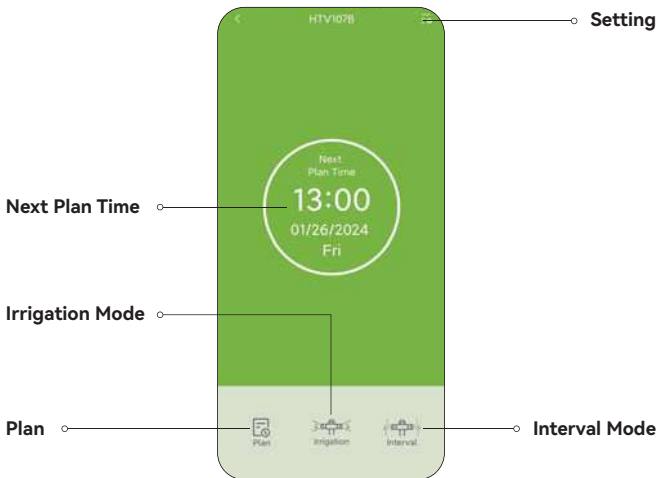

- **Setting**

Tap the setting icon on the top right corner, you will enter the page for device setting and customize the device watering.

- **Next Plan Time**

After setting your watering schedules, the device page will show the next plan time.

- **Irrigation Mode**

Tap "Irrigation" and you can set the watering time from 1min to 12h for manual watering, and then tap "Confirm" to start watering. While the manual watering is running, tap "Irrigation" and then tap "Confirm" to stop watering.

- **Interval Mode**

Tap "Interval" and you can set the watering time from 1min to 12h, run time and interval from 1s to 60mins for misting. After setting, tap "Confirm" to start misting. While the misting mode is running, tap "Interval" and then tap "Confirm" to stop watering.

- **Plan**

Tap "Plan" and you will enter the plan set page, up to 6 plans are available. You can also set "Rain Delay" for rainy days by 24/48/72H. Tap the calendar icon to check your plan.

4.3 Basic Setting

Find the icon on the top right corner of the APP home page to "**Settings**" page. In the basic settings, you can check and manage the device information, such as name, interface and description. There are also some advanced settings you can set up for the specific functions:

Interval Irrigation: Set the mist time and interval time for manual misting mode.

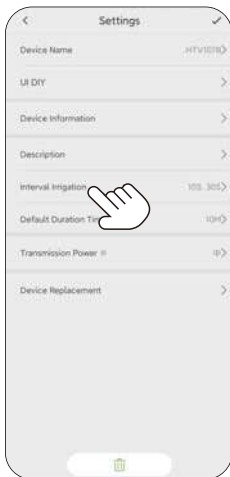

Default Duration Time: Set the default watering duration for manual irrigation mode.

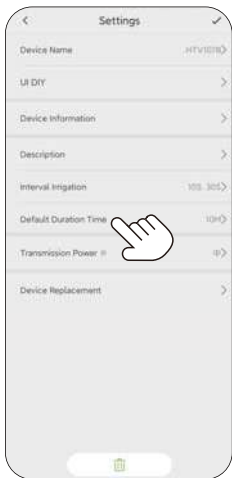

4.4 Plan Setting

Select **Plan**  and start to create a new auto-watering plan.

Set a watering mode first: Press the icon **+** on the top right corner of the **"Irrigation Plan"** page to set irrigation plan.



Irrigation Mode: Normal watering mode with basic start time, duration and frequency setting.

Interval Mode: Special misting mode with customizable mist time and interval period for intermittent plant watering.

Start Time: Set the time that the plan starts.

Duration: Set the duration for watering plans.



Repeat: Set the watering frequency for your plans.



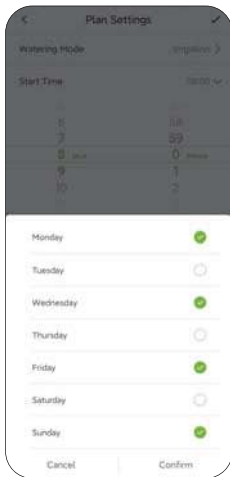

After finish setting, press the check icon on the top right corner to save your plan and you will see the plan overview on the **Plan** page. You can turn on/off the plan by the button on the right. Up to **SIX** plans can be created.



Plan Calendar: Tap the calendar icon on the top right corner on the **Plan** page, and you can check the overview of all your watering schedules.



4.5 Manual Watering

1. **Manual Irrigation Mode:** Tap **"Irrigation"** on the bottom of the **Plan** page, and you can set the manual watering time from 1min to 12h for manual watering, and then tap **"Confirm"** to start watering. While the manual watering is running, tap **"Irrigation"** and then tap **"Confirm"** to stop watering.

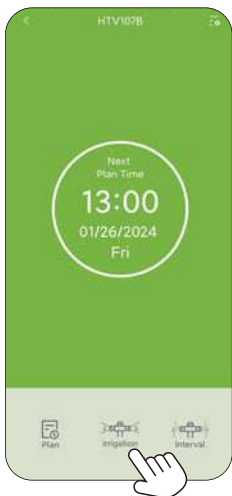

2. Manual Interval Mode

Tap "Interval" on the bottom of the **Plan** page, and you can set the watering time from 1min to 12h, run time and interval from 1s to 60mins for misting. After setting, tap "Confirm" to start misting. While the misting mode is running, tap "Interval" and then tap "Confirm" to stop watering.



Note: When you turn on manual watering, if there is a plan running now or there will be a plan starting during your manual water time, the schedule will be skipped for this time.

4.6 Weather Conditions & Devices' Next Plan Time

In the **Info** screen, you can check for the weather conditions and the devices' next watering time. For the first time, you need to tap **"Get Location"** and then tap **"Save"** to save your location information, and the **Info** screen will display the weather conditions of the day, including temperature, humidity, rain forecast, wind direction and wind speed, as well as the 7-day weather conditions. You can also correct your location information as follows: **Me → HOME Management → My Home → Location → Get Location → Save**. The weather information can help you with decisions of whether to adjust your watering schedules according to the weather. Tap the icon on the top right corner of **Info** screen to turn on/off weather display, or add/delete devices' next plan time display.

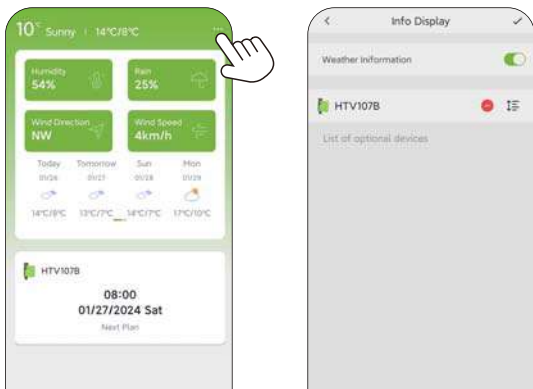

4.7 Plan Overview & Setting

In the **Plan** screen, you can check the plan you set of all your connected devices and adjust each plan here conveniently. You can also set the **Rain Delay** by 24/48/72H easily or turn off the **Rain Delay** schedule through the button on the right or the icon on the top right corner.



4.8 Home Management

RainPoint supports adding family members and sharing your home device to achieve co-management the home irrigation system with your family.

1. Tap **Me** at the bottom of the APP home screen.
2. Select **HOME Management**. You can set the current home or create a home.
3. Set your **HOME Name, Room or Zone, Location, Time Zone, Members, Units Format and Currency**.

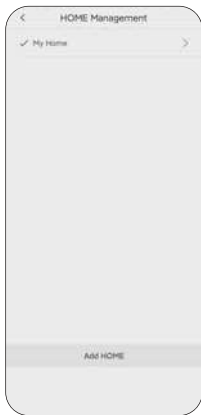

4.9 Third-Party Voice Service

How to get third-party control / voice control?

If you have a **Google Assistant** or **Amazon Alexa**, please tap **"Third-party Voice Service"** in **"Me"** page, and then tap **"Google Assistant"** or **"Amazon Alexa"** to check the operation guide to connect your WiFi water timer to the voice control device. After successfully connecting, you can control the WiFi water timer by voice.

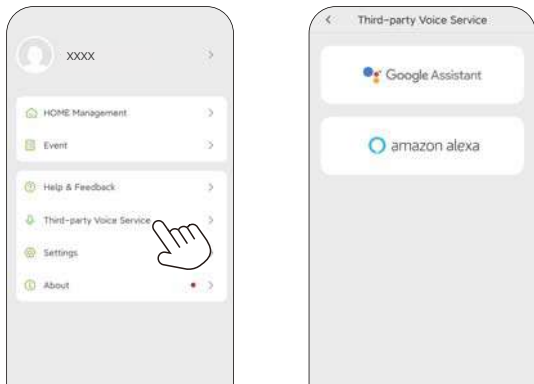

NOTE: The WiFi water timer can only perform simple voice commands, such as **"turn on"** or **"turn off"** and the commands should be **English only**. If you have any questions or suggestions about this feature, please feel free to contact us.

4.10 Reset The Device

How to reset the water timer?

Step 1. Remove all batteries from the battery compartment.

Step 2. After 10 seconds, insert 4 fresh AA alkaline batteries into the compartment of the timer.

Step 3. While installing the battery, press and hold the button on the timer without releasing it until the LED indicator quickly flashes (2 times per second), indicating that the water timer is restored to pairing mode.

4.11 The Meaning Of Led Light

LED indicator color of HTV107B Bluetooth water timer.

1. **Power-on reset:** The RED and WHITE lights are on in order for one second when the machine is turned on.
2. **Pairing state:** The RED light flashes quickly (0.2 seconds on, 0.2 seconds off alternatively) to indicate that the timer enters the timing pairing status. If the timer connects to WiFi successfully, the WHITE light will be on for 2 seconds; if fails, the RED light will be on for 2 seconds.
3. **Irrigation mode:** The WHITE light flashes once every 4 seconds.
4. **Interval mode:** The WHITE light flashes twice every 4 seconds.
5. **Low battery state:** The RED light flashes once every 3 seconds, indicating that the battery is in a low voltage state.

5. Troubleshooting

Problem	Possible Factors	Solution may help
Can't turn on /off the valve	<ul style="list-style-type: none">• Low battery.• Impurities in water inlet.• Unstable network or delayed response.	<ul style="list-style-type: none">• Replace fresh batteries .• Regularly clean the filter port of impurities to avoid disruptions in use.• Wait a while and try again.
Timer won't connect	<ul style="list-style-type: none">• Mobile phone Bluetooth is not kept open.• The distance between the phone and the water timer is too long while connecting.	<ul style="list-style-type: none">• Check whether the cell phone Bluetooth is in open state.• Ensure the water timer is close to your phone while connecting.• Repair the timer: Press the button until the red light flashes rapidly. (Or remove the device and then reconnect again.)
Hub cannot connect	<ul style="list-style-type: none">• Not using 2.4GHz WiFi.• Incorrect WiFi password.• Hub not in pairing mode.	<ul style="list-style-type: none">• Confirm 2.4GHz WiFi connection.• Confirm that the WiFi password has been entered correctly.• Press and hold the button on the timer without releasing it until the blue LED indicator quickly flashes (2 times per second), indicating that the water timer is restored to pairing mode.

Problem	Possible Factors	Solution may help
Plan not executed on time	<ul style="list-style-type: none"> • There are impurities in the water inlet filter. • Rain delay function is on. • The conditions for automatically stopping the plan when it rains is set. • In a low-power state, the timer enters low-power protection mode and does not execute the schedule. • No irrigation time/ period parameters are currently set. 	<ul style="list-style-type: none"> • Inlet impurities need to be cleared regularly so that they do not clog up and interfere with the irrigation programs. • Check if the rain delay function is on and turn it off. • Check if the conditions for automatically stopping the plan when it rains is set and delete the setting. • Replace the batteries with new ones. • Confirm that the irrigation time/period parameters are set.
Water inlet leakage	<ul style="list-style-type: none"> • No filter or not be placed horizontally. • The faucet is not the right standard 3/4" size. 	<ul style="list-style-type: none"> • Add a filter and make sure it's placed horizontally in the inlet. • Make sure the faucet is a 3/4" faucet. • Strengthen it with teflon tape.
Low water pressure	<ul style="list-style-type: none"> • Filter blockage. • Inlet pressure is not enough to support watering. 	<ul style="list-style-type: none"> • Check if the filter is clogged, if so, clean or replace the filter. • Make sure the timer is installed properly and not cross-threaded. • Installation of a booster pump or other auxiliary equipment to increase water pressure.

6. Precautions

1. For outdoor use with cold water only. Placing the timer in the sheltered outdoors will prolong its life.
2. To avoid damage, please tighten it without using tools.
3. The filter should be placed horizontally in the water inlet to prevent leakage.
4. When the power is low, please replace the batteries to avoid the interruption of normal operation; when replacing the batteries, please make sure that the battery compartment is dry.
5. When the timer compartment is not in use, please remove the batteries and store it indoors.
6. Don't use the timer under a temperature more than 120°F(50°C), or less than 38°F (3°C).
7. Don't subject the product to extreme force and shock.
8. Severe electrical shock could result if water is sprayed into outlets or sources of electrical current. Never immerse the product in water.
9. Do not mix old and new batteries or different types of batteries.
10. Please install the timer vertically to the ground to avoid valve body damage.
11. Under freezing temperatures, timers should be removed from the faucet and stored indoors to avoid potential freezing damage.
12. Please clean filters regularly and replace if it is worn in order to prolong working life of timer.

7. Warranty Policy

RainPoint provides a 1-year warranty against manufacturing defects in materials and workmanship from the date of purchase. During the warranty period, we'll replace free of charge the product found to be defective under reasonable use and service as determined solely by RainPoint. To extend and activate your warranty, please email us with your order ID at support@rainpointonline.com and we'll respond within 24 hours.

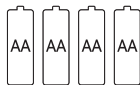

Not included



Points de collecte sur www.quefairedesdechets.fr
Privilégiez la réparation ou le don de votre appareil !

8. FCC Statement (FCC ID: 2AWDBHTV107B)

This device complies with Part 15 of the FCC Rules. Operation is subject to the following two conditions:

1. This device may not cause harmful interference.
2. This device must accept any interference received, including interference that may cause undesired operation.

FCC Warning: Any changes or modifications not expressly approved by the party responsible for compliance could void the user's authority to operate this equipment.

Note: This equipment has been tested and found to comply with the limits for a Class B digital device, pursuant to Part 15 of the FCC Rules. These limits are designed to provide reasonable protection against harmful interference in a residential installation. This equipment generates, uses, and can radiate radio frequency energy, if not installed and used in accordance with the instructions, may cause harmful interference to radio communications. However, there is no guarantee that interference will not occur in a particular installation. If this equipment does cause harmful interference to radio or television reception, which can be determined by turning the equipment off and on, the user is encouraged to try to correct the interference by one of the following measures:

- Reorient or relocate the receiving antenna.
- Increase the separation between the equipment and the receiver.
- Connect the equipment into an outlet on a circuit different from that to which the receiver is connected.
- Consult the dealer or an experienced radio/TV technician for help.

Note: The manufacturer is not responsible for any radio or TV interference caused by unauthorized modifications to this equipment. Such modifications could void the user's authority to operate the equipment.

9. Customer Support

If you find it difficult to set up and want to watch the setting tutorial video, please subscribe to our channel RainPoint on YouTube.



Or scan the QR code to visit the RainPoint channel on YouTube quickly.

If the app and the user manual don't have what you're looking for, and need some help about Rainpoint, please contact us by **LOT NO.:** XXXXXX (on the back of the device)



Need Help ?

Scan the QR code for more help.
or Email:
support@rainpointonline.com