

Segway Navimow X3 Series User Manual



Table of Contents

| | |
|---|----|
| 1. Overview | 3 |
| 1.1 Introduction | 3 |
| 1.2 How EFLS 3.0 works | 4 |
| 1.3 Safety Warnings | 5 |
| 1.4 Symbols and Decals | 7 |
| 1.5 What's in the Box? | 8 |
| 1.6 Parts and Functions | 9 |
| 1.7 Specifications | 13 |
| 1.8 Accessories (sold separately) | 15 |
| 2. Installation and Mapping | 19 |
| 2.1 Before You Start | 19 |
| 2.2 Activate the Mower | 20 |
| 2.3 Find Locations | 21 |
| 2.4 Install GNSS Antenna and Charging Station | 23 |
| 2.5 Upgrade to the Latest Firmware | 25 |
| 2.6 Map out the Work Area | 26 |
| 3. Daily Use | 30 |
| 3.1 Mow | 30 |
| 3.2 Navimow App | 32 |
| 3.3 Mower Settings | 34 |
| 3.4 Safety Features | 35 |
| 3.5 Advanced Features | 36 |
| 3.6 App Settings | 37 |
| 4. Maintenance | 38 |
| 4.1 Cleaning | 38 |
| 4.2 Replace Blades | 39 |
| 4.3 Key Parts Maintenance | 39 |
| 4.4 Transportation | 40 |
| 4.5 Battery | 40 |
| 4.6 Power Supply | 41 |
| 4.7 Storage | 41 |
| 4.8 Recycling and End-of-life Disposal | 42 |
| 5. FAQ & Troubleshooting | 42 |
| 6. Important Information | 43 |
| 6.1 Europe | 43 |
| 6.2 North America | 51 |
| 7. Contact Us | 57 |

Welcome

Thank you for choosing Navimow X3 Series!

Introducing the Segway Navimow X3 Series – the latest wire-free robotic lawn mowers. The Segway Navimow X3 Series achieves an efficiency level two times faster than the industry average, making it the ultimate solution for handling larger lawns. Innovative blade upgrades and accelerated mowing speed offer unparalleled performance, giving you a pristine lawn with every use.



1. Overview

1.1 Introduction

Segway Navimow X3 Series

Segway Navimow pioneered residential robotic lawn mowers without boundary wires, launching the Navimow H Series as its first-generation product in 2022. Now, Segway presents the Navimow X3 Series, a new line of robotic lawn mowers designed for larger lawns. The X3 models can cover lawns ranging from 1500 m² to 10,000 m² (0.5 acre to 2.5 acres for the US and Canada). This makes the X3 Series the optimal solution for effortless lawn maintenance.

Navimow utilizes an advanced robotic mowing system that leverages a virtual boundary, eliminating the need for cumbersome perimeter wiring. Easy to operate and manage, the Segway Navimow X3 Series frees up your time for more enjoyable pursuits while ensuring a consistently immaculate lawn.

The Navimow system comprises a robotic lawn mower, a charging station, a GNSS (Global Navigation Satellite System) antenna, and a dedicated app. The robotic lawn mower and GNSS antenna concurrently receive positioning signals from satellites to pinpoint the mower's location and define the work area. The charging station replenishes the mower's battery. The app facilitates remote control of the mower and provides real-time status monitoring.

Mower

The robotic lawnmower is powered by a rechargeable lithium-ion battery pack. Using the Navimow app on your phone, you can define the boundaries of a work area. The mower will then automatically cut the grass within the boundaries. The mowing paths are calculated by the algorithm according to the shape of the work area to achieve the highest mowing efficiency. If the battery runs low before finishing a mowing task, it will automatically go back to its charging station to recharge.

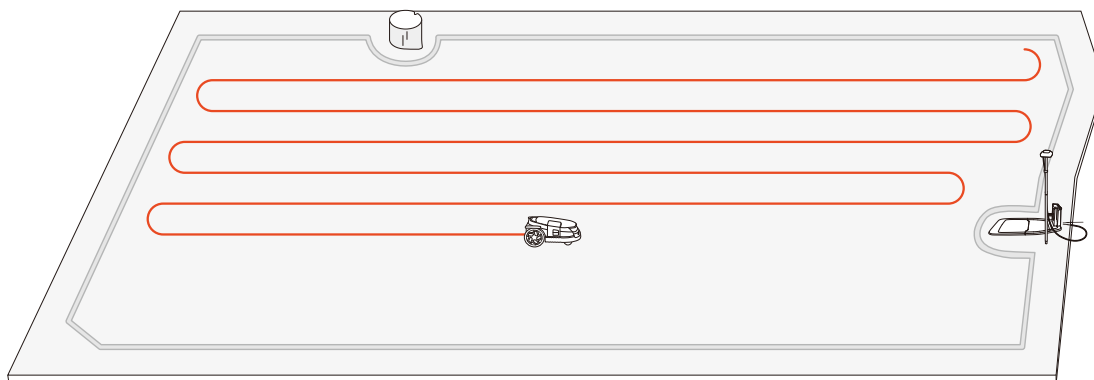

3

Navimow App

The Navimow app is an important part of the Navimow system. You can follow the interactive guidance shown via the app to complete the system installation and set up the work area. You can also use the app to adjust the settings of the mower, customize the work area, view the work status of the mower, control the mower remotely, etc. You can also get the latest and most comprehensive official Help and Support content through the app.

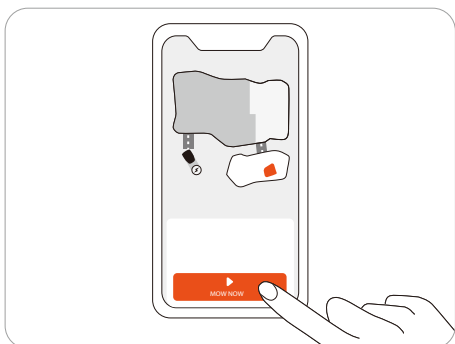

1.2 How EFLS 3.0 works

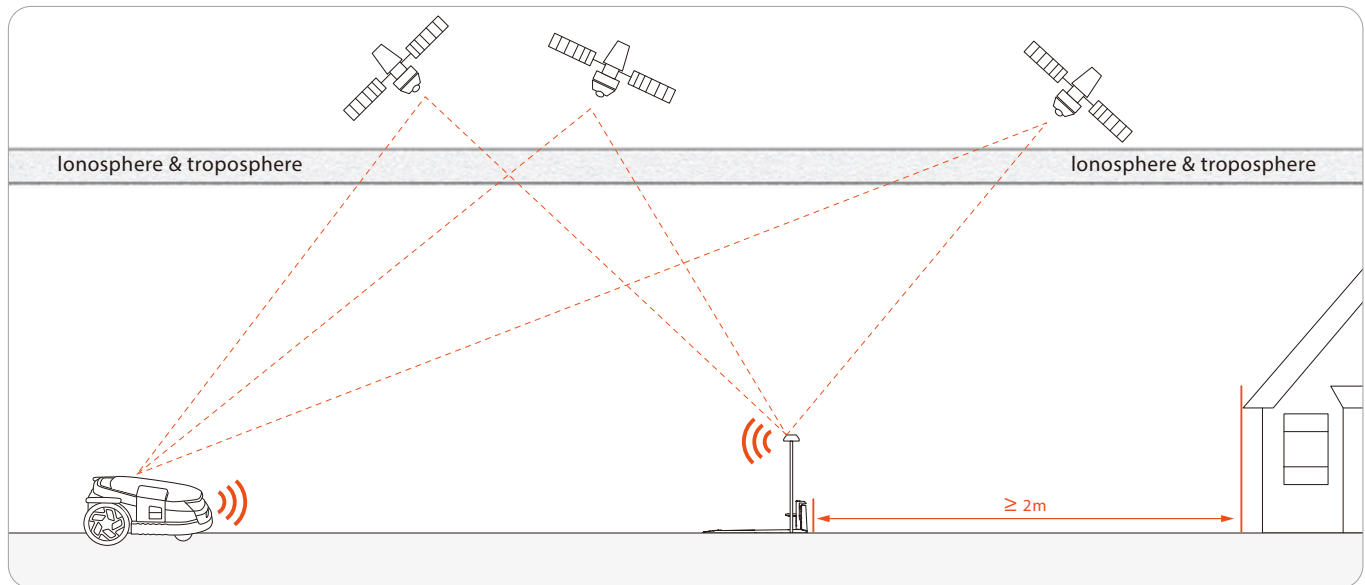

EFLS (Exact Fusion Location System) is an advanced positioning system that integrates multiple sensors to provide precise navigation for robotic lawn mowers. Developed to address the pressing issues of low mowing efficiency and complex setup in automated lawn care, EFLS enables wireless robotic lawn mowers to operate within virtual boundaries with exceptional accuracy. By replacing traditional boundary wires with virtual mapping, EFLS technology saves time and significantly enhances mowing efficiency, laying the groundwork for precision lawn mowing. Positioned at the forefront of smart lawn care solutions and automation, EFLS redefines efficiency and user convenience for homeowners, commercial groundskeepers, and facility managers alike.

EFLS 3.0, as implemented in the Navimow X3 Series, further advances precision lawn mowing by incorporating left and right camera VSLAM into the existing monocular VSLAM of EFLS 3.0, expanding the Field of View (FOV) to an impressive 300 degrees for unparalleled reliability. A pioneering solution in automated lawn care, EFLS 3.0 is the industry's first system to integrate VSLAM and Visual-Inertial Odometry (VIO) with dual RTK antennas. This unique configuration, optimized for large and complex areas, positions EFLS as an industry leader and trendsetter, paving the way for future advancements in robotic lawn mowers.

Coupled with refined VIO technology, EFLS 3.0 enhances positional accuracy for seamless navigation in challenging environments. Dual RTK antennas provide superior coverage and accuracy, enabling robust operation in large, complex lawns. With a triple-camera configuration, EFLS 3.0 doubles the system's visual coverage, empowering mowers to confidently navigate challenging areas such as narrow passages or low-texture walls. The dual RTK antennas further optimize satellite signal reception, while an intelligent algorithm dynamically adjusts primary and secondary base station data, ensuring robust RTK-based positioning stability across expansive and segmented lawns.

With each iteration, EFLS technology moves closer to realizing a vision of fully automated, high-precision lawn care that is accessible, efficient, and adaptable. EFLS technology redefines automated lawn care through precision, innovation, and robust functionality, shaping a future where intelligent lawn management becomes the standard across residential, commercial, and public domains. The future of lawn care has arrived, and EFLS is at the forefront.

1.3 Safety Warnings

IMPORTANT READ CAREFULLY BEFORE USE KEEP FOR FUTURE REFERENCE

- 1) Be sure to install and operate the Navimow (referred to as the mower in the manual) and the charging station according to the instructions. Go to navimow.segway.com for the complete User Manual and the latest user materials.
- 2) The mower is for consumer use only. Using the mower for purposes other than mowing can bring serious injury. To avoid risks of injuries, please read and understand all the warnings and cautions. Please understand that you can reduce the risk by following the instructions and warnings in this manual, but you cannot eliminate all the risks. The operator or user is responsible for accidents or hazards occurring to other people on their property.
- 3) Navimow has many built-in safety sensors, however, safety risks still exist. Set a mowing time when there are no people or pets on the lawn. Inform the neighbors about the risks for accidents or hazards. When using the mower on a public lawn, or when your lawn is open to your neighbor or street, protect or fence the lawn, or put up a warning sign around the working area that says: **WARNING! Automatic lawnmower! Keep away from the machine! Supervise children!**
- 4) DO NOT modify the mower by yourself. Modifications could interfere with mower operations, result in serious injury and/or damage, or void the Limited Warranty. Use only Navimow approved parts and accessories.
- 5) The manufacturer recommends the user to be 18–70 years old. Be sure to get the necessary training before operating the machine.

WARNING

Never allow children, persons with reduced physical, sensory or mental capabilities or lack of experience and knowledge or people unfamiliar with these instructions to use the machine. Local regulations may restrict the age of the operator.

Before Mowing:

- Regularly check that all parts of the mower can function normally.
- For the best mowing results, it is recommended to mow in dry weather. When mowing in the rain, grass clippings can get stuck at the bottom of the mower, causing the mower to slip. DO NOT mow in bad weather, such as heavy rain, thunderstorms or snow.
- Periodically inspect the area where the mower is to be used and remove all stones, sticks, wires, toys, and other foreign objects. The Limited Warranty does not cover damages caused by objects left on the lawn.
- To avoid possible damage, keep the operating mower at least 1 m (3 feet) away from sprinkler heads. The mower and the sprinklers should NOT work simultaneously. Adjust the mowing schedule so that it works at a different time than any sprinklers.
- NEVER allow children to touch the power supply unit, charging station, blades, the battery compartment, or any parts with gaps such as the wheels.

5

WARNING

Never operate the machine or its accessories if the guards or shields are damaged, or if the cord is damaged or worn.

When Mowing:

- Keep away from the rotating blades! DO NOT put hands or feet under or near the rotating blades.
- Watch out for small flying objects or stones during mowing. Keep a safe distance from the mower when it is operating.
- DO NOT leave the machine to operate unattended if you know that there are pets, children, or people in the vicinity.
- DO NOT reach beyond the capabilities of the mower. If you are remotely controlling the mower and its accessories, it is recommended to do so from a seated or stationary position. If you are standing or walking during operation, keep your balance and watch your steps.

WARNING

- DO NOT allow children to be in the vicinity or play with the mower when it is operating.
- DO NOT lift the mower while in operation. DO NOT ride on the mower.
- DO NOT mow on areas with slopes steeper than the maximum incline inside the working area (50%), as well as the boundary (25%).
- If the mower makes an abnormal sound or signals an alarm, press the STOP button immediately.
- If there are abnormal vibrations, turn off the mower, place it on level ground for about 30 seconds and then restart. If the issue persists, contact authorized after-sales service.
- DO NOT touch moving hazardous parts before they have come to a complete stop.

Safe Usage:

- DO NOT operate or charge the mower outside the temperature limits: 0–40°C (32–104°F), because low/high temperatures can decrease mower performance and even lead to accidents.
- DO NOT place anything on the mower or the charging station.
- It is recommended to conduct regular maintenance of the mower (See Maintenance in the User Manual) by an adult.
- Regularly check the warning devices to ensure they are effective. These devices include the buzzer, the LED light on the charging station, and the ambient light on the mower.
- Before charging, please read How to Charge in the User Manual. Improper use may cause electric shock, overheating, or leakage of corrosive liquid.
- Use only the original battery pack or that of the same model as specified by Navimow. Each mower contains one battery pack.

Depending on the specific mower model, the rated capacity of the battery is 6 Ah, 8 Ah, 10 Ah, and 12.8 Ah. Contact after-sales service and have a professional technician replace the battery pack.

- Do not use non-rechargeable batteries. For the purposes of recharging the battery, only use the detachable supply unit provided with this appliance. For the European Union and Norway: NBW32D007D0N01-EU; For the United Kingdom: NBW32D007D0N01-UK; For Switzerland: NBW32D007D0N01-CH; For the US and Canada: NBW32D007D0N01-US; For Australia and New Zealand: NBW32D007D0N01-AU.
- DO NOT dismantle or puncture the battery casing. Keep away from metal objects to prevent short circuit. Keep away from fire, heat and direct sunlight.
- For information about battery and electrical waste, please contact your household waste disposal service, your local or regional waste management office, or your point-of-sale.
- When replacing the blades, please be careful and wear protective gloves as the blades may cause damage.
- If the cord on the power supply or the extension cable becomes damaged or entangled during use, disconnect the power supply from the power socket and then untangle. To avoid a hazard, pull the body of the plug rather than the cord when separating the power supply from the power socket. Contact after-sales service and have a professional technician repair or replace the cord.
- When cleaning, inspecting for damage, or checking for abnormalities, the mower must be powered off, and the charging station must be unplugged from the power supply.

1.4 Symbols and Decals

Please study the symbols on the product and labels carefully and understand their meaning:



⚠ WARNING-Read instruction manual before operating the machine.



⚠ WARNING-Do not touch rotating blade.



⚠ WARNING-Keep a safe distance from the machine when operating.



⚠ WARNING-Do not ride on the machine.



⚠ WARNING-Operate the disabling device before working on or lifting the machine*.

* The disabling device hereby refers to the safety lock. Before lifting or operating the mower, enable the safety lock by pressing MOW+HOME for more than 3 seconds.



⚠ WARNING-It is not permitted to dispose of this product as normal household waste. Ensure that the product is recycled in accordance with local legal requirements.



This product conforms to the applicable EC Directives.



This product conforms to the regulations of Restriction of Hazardous Substances.



Before charging, read the instructions.



Class II appliance



Polarity of the charging port



Level VI efficiency



SMPS incorporating a short-circuit-proof safety isolating transformer (inherently or non-inherently)

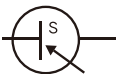

SMPS (Switch mode power supply unit)



Protected from total dust ingress and from high-pressure water jets from any direction



The maximum altitude of use is 5000m



Direct current

ta: 40°C

The maximum temperature of use is 40°C



Class III appliance



Alternating current

1.5 What's in the Box?

If there are missing or defective parts, please contact after-sales service. We recommend retaining the package materials for future transportation and shipping.

- Segway Navimow X3 Series

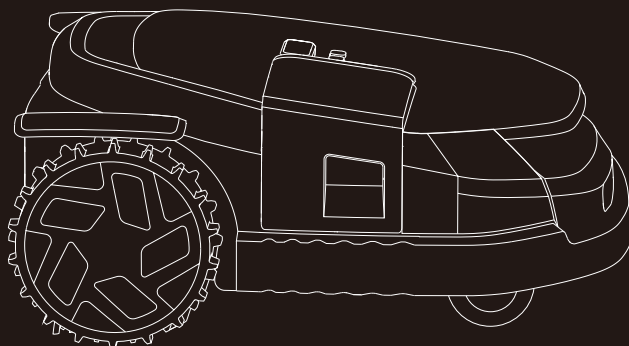

GNSS antenna

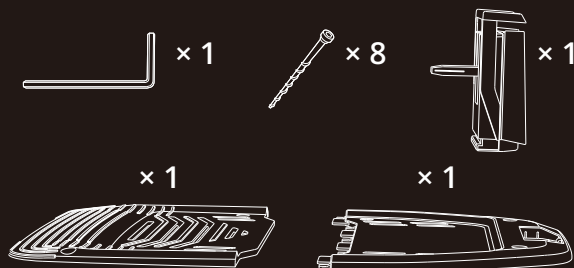

Charging station and the installation kit



× 1

Power supply adapter (for charging station)



× 1

Extension cable for the power supply

⚠ WARNING

Sharp edges. Do not point at people.

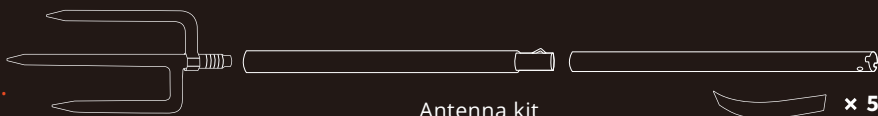

Antenna kit

× 5

- User materials

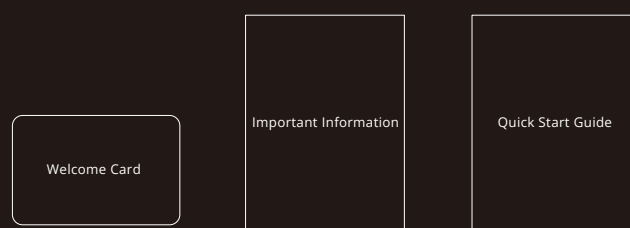

Welcome Card

Important Information

Quick Start Guide

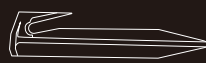

× 20

Pegs to secure the extension cable



× 18



× 18

Spare blades and bolts

1.6 Parts and Functions

1.6.1 Mower

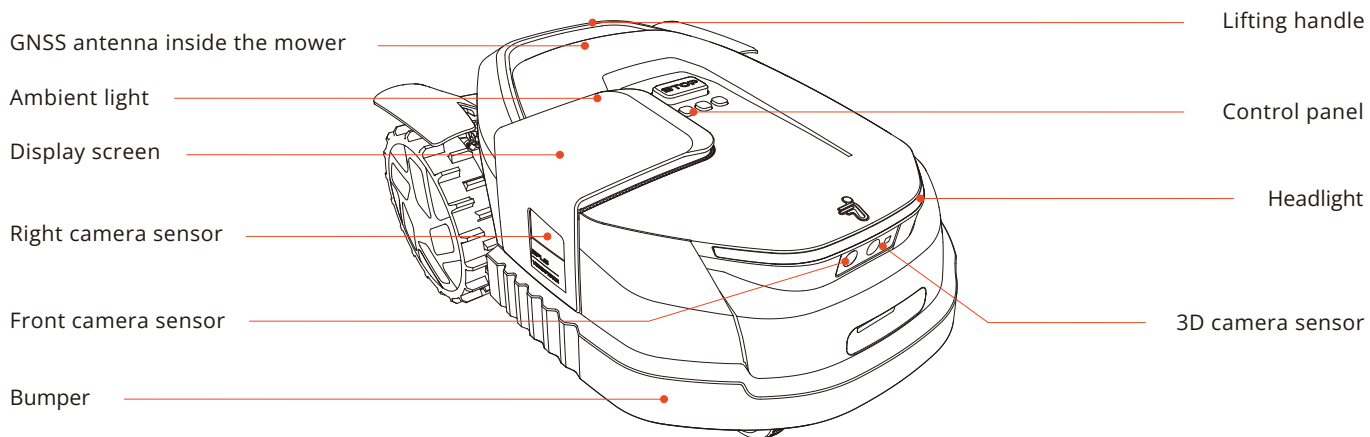

- Control panel: The buttons can be used to start mowing, lock/unlock the mower, send the mower for recharge, and other basic operations.
- Display screen: This dot-matrix display screen uses icons and animation to show the status of the mower.
- Ambient light: Specific lighting effects to remind you to pay attention to the status of the mower.
- Headlight: The white LED light is used for illumination, especially during nighttime. It also lights up when the mower parks on the charging station.
- GNSS antenna inside the mower: In addition to the GNSS antenna, there is also a GNSS antenna inside the mower to improve positioning accuracy. See 1.2 How the EFLS 3.0 Works.
- Left, right, and front camera sensors: Detects non-grass objects to avoid bumping into them, EFLS 3.0 uses the cameras to capture key visual features of the lawn.
- 3D camera sensor: This is a ToF (Time-of-Flight) sensor used for obstacle avoidance and mowing along the edges. Unlike other camera-based sensors that rely on ambient light for object detection, the ToF sensor works well under all kinds of lighting conditions.
- Bumper: When the bumper hits an obstacle and triggers the internal sensor, the mower will stop and turn away to avoid the obstacle.
- Lifting handle: Helps you to lift the mower up when necessary.

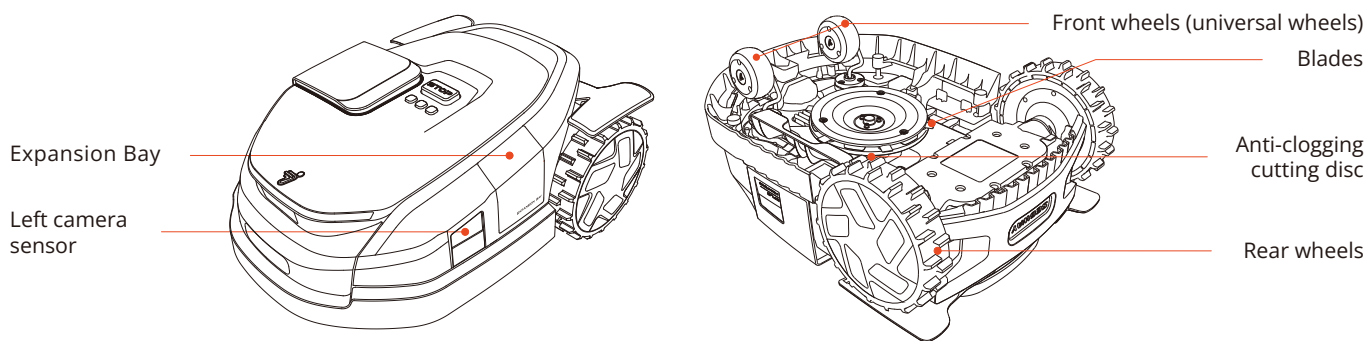

- Blades: The 6 blades can rotate freely after being attached to the disc. When mowing, the spinning blade disc will generate centrifugal force to keep the blades pointing outside so that the blades can cut grass. When hitting an obstacle, the blade will turn inside. See 4.2 Replace Blades for instructions on replacement.
- Anti-clogging cutting disc: Reduces chances of grass clippings getting stuck in the blades, so the blades can be used for a longer time.
- Expansion Bay: An external port used for installing additional accessories, allowing customization in the future.

1.6.2 Display and Control

| Operation | Display screen | Lights on the mower | Operation | Display screen | Lights on the mower |
|--|----------------|--|--|----------------|-----------------------------------|
| Powering on: Press OK and hold for 1 second to power on the mower | | Pulsing yellow | Returning to the charging station: Press HOME and then OK | | Solid blue or pulsing yellow |
| Initialization: Wait 30 seconds until the mower is fully powered on | | Pulsing yellow | Stopped: Press STOP | | Solid red |
| Powering off: Press and hold on to OK for 3 seconds | | Pulsing yellow | Child lock: Turn it on via the app | | / |
| Forcing a power-off: Press and hold OK for 10 seconds. | | / | Safety lock: Press MOW+HOME for more than 3 seconds to lock the mower | | / |
| Error during power-on: Press and hold on to OK for 10 seconds | | Flashing red | Unlock: Press any button on the mower and then enter the PIN code | | / |
| Charging | | Pulsing green: Charging is in progress Solid green: Fully charged | Standby: Press OK to switch and view different status | | Battery level + poor GPS signal |
| Error: Follow the instructions via the app to clear the error code | | Flashing red | | | Battery level + stable GPS signal |
| Lifted up, tilted, or turned over | | Solid red | | | Cellular network + Bluetooth |
| Firmware upgrade | | Pulsing white | | | Wi-Fi network + Bluetooth |
| Mapping | | Solid blue or pulsing yellow | Animals nearby | | / |
| Blades are about to rotate | | Flashing white | Mowing: Press MOW and then OK | | Solid blue or pulsing yellow |

1.6.3 How to Enter PIN Code

Enter the PIN code before operating the mower. Press MOW or HOME to change the number and press OK to confirm the code.

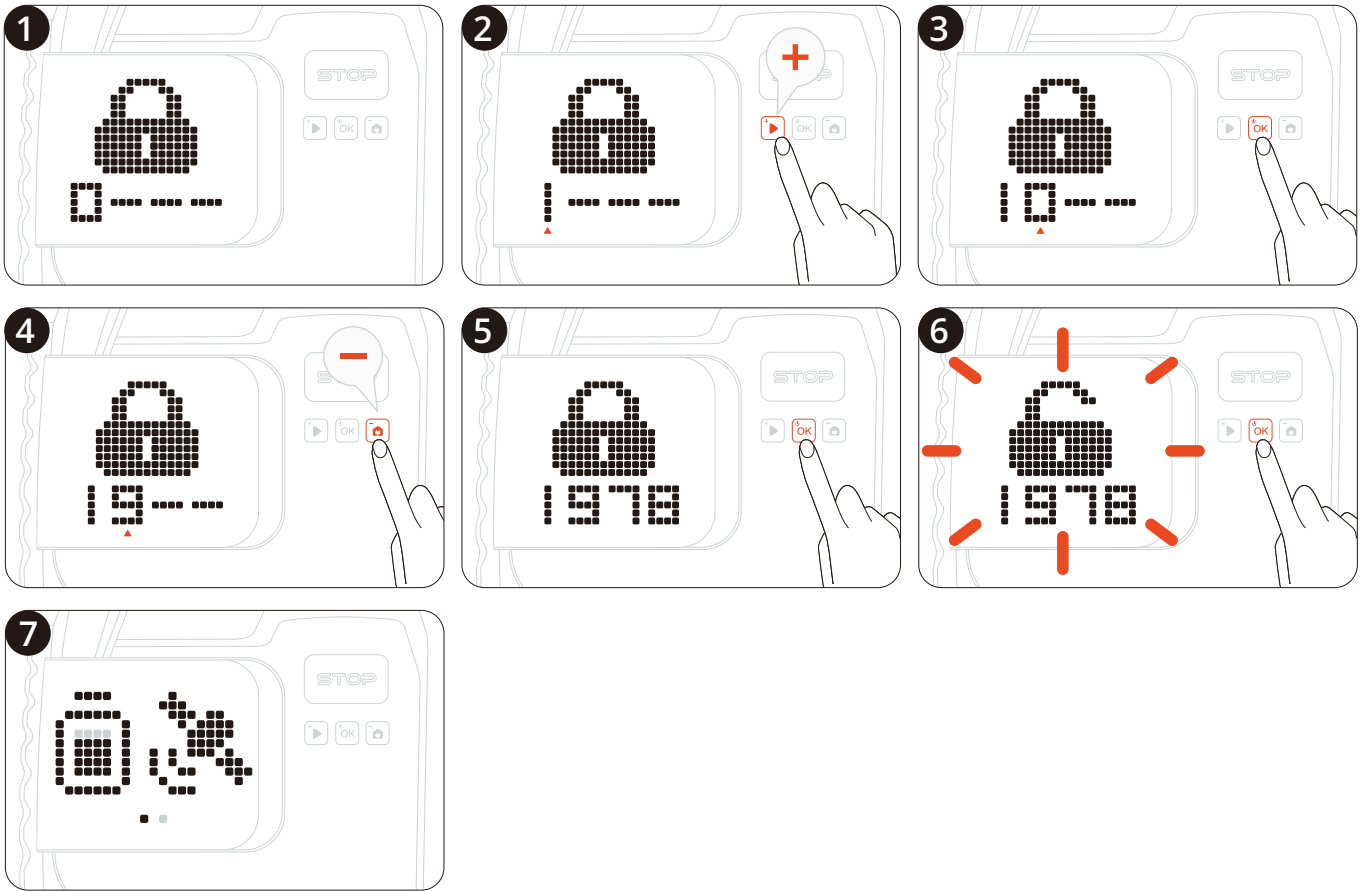

1.6.4 Charging Station and GNSS Antenna

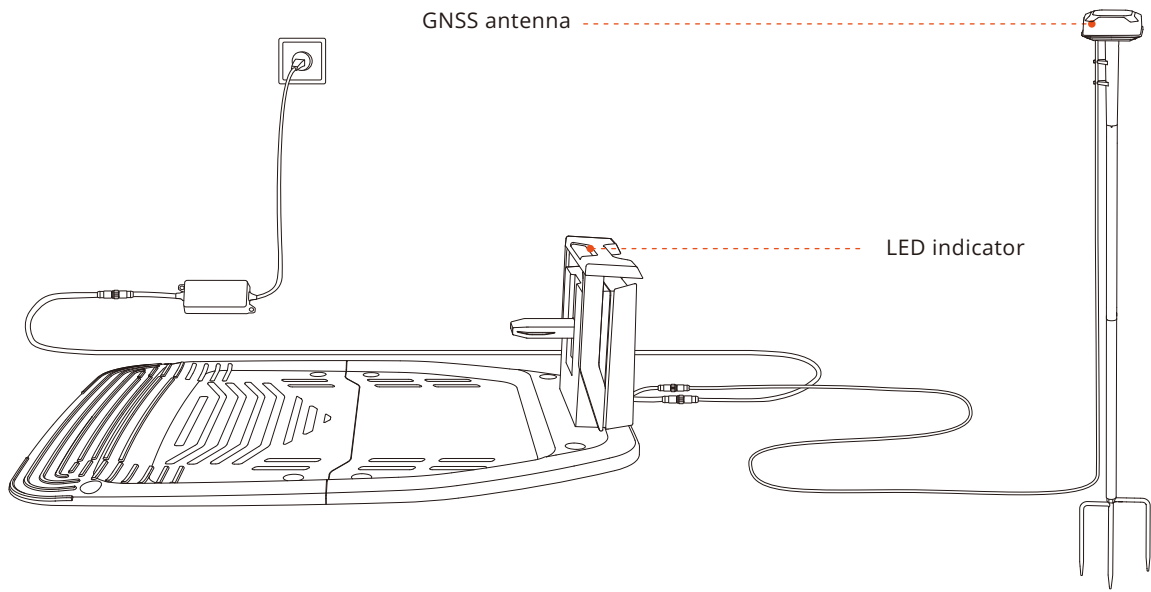

- GNSS antenna: Receives satellite signals to improve the positioning accuracy of the mower. For large lawns and complex yards, use dual antennas to expand the GPS signal coverage.
- LED indicator: Indicates the charging status in green light.

1.7 Specifications

| SKU | | X315 | X330 | X350 | X390 |
|--------------------|--|---|---|--|--|
| Basic Information | Model Suffix and Supported Regions: | E: Europe A: Australia and New Zealand N: United States and Canada | | | |
| | Product Name | Segway Navimow X3 Series | | | |
| | Brand | Segway Navimow | | | |
| | Dimensions: Length × Width × Height | 698 x 550 x 307 mm (27.5 x 21.7 x 12.1 in) | | | |
| | Net Weight (Battery Included) | 19.55 kg (43.10 lbs) | 19.84 kg (43.74 lbs) | 19.84 kg (43.74 lbs) | 19.90 kg (43.87 lbs) |
| | Material | Mower frame: PC+ASA | | | |
| Mower Parameters | Recommended Mowing Area | X315E, X315A: 1500 m ² X315N: 0.5 acre | X330E, X330A: 3000 m ² X330N: 1 acre | X350E, X350A: 5000 m ² X350N: 1.5 acres | X390E, X390A: 10,000 m ² X390N: 2.5 acres |
| | Typical Mowing Time Per Full Charge[1] | About 120 min | About 160 min | About 200 min | About 240 min |
| | Area Capacity per Hour | About 300 m ² (0.074 acre) | | About 350 m ² (0.087 acre) | |
| | Cutting Width | 23.7 cm (9.33 in) | | | |
| | Cutting Blades | 6 | | | |
| | Cutting Height | Europe, Australia, New Zealand: 20-70 mm (1.2-2.8 in) United States and Canada: 2-4 in (50-100 mm) | | | |
| | Cutting Height Adjustment | Electronic | | | |
| | Cutting Disc | Anti-clogging cutting disc | | | |
| | Charging Time | About 60 min | About 65 min | About 80 min | About 100 min |
| | GNSS Working Mode | GPS, Beidou, Galileo | | | |
| Noise Emissions[2] | Measured Sound Power Level LWA | 60 dB(A) | | | |
| | Sound Power Uncertainties KWA | 3 dB(A) | | | |
| | Sound Pressure Level LpA | 52 dB(A) | | | |
| | Sound Pressure Uncertainties KpA | 3 dB(A) | | | |
| Working Conditions | Working Temperature | 0–40°C (32–104°F); 10–35°C (50–95°F) recommended | | | |
| | Storage Temperature | -20–50°C (-4–122°F); 10–35°C (50–95°F) recommended | | | |
| | IP Rating | IP66 for mower body, charging station, and power supply | | | |
| | Max. Incline Inside Working Area | 50% | | | |
| | Max. Incline at Boundary | 25% | | | |

| | | | | | |
|--------------------|-----------------------------------|---|---------------|----------------|------------------|
| Working Conditions | Min. cutting angle around corners | 90° | | | |
| Connectivity | Bluetooth® Frequency Range | 2400.0–2483.5 MHz | | | |
| | ISM Band Radio Connection | Europe: 865-868 MHz Australia, New Zealand, United States and Canada: 915-918 MHz | | | |
| | Wi-Fi/Cellular Network | Wi-Fi 2.4 GHz/5.0 GHz Europe: LTE-FDD: B1/B3/B5/B7/B8/B20/B28 LTE-TDD: B38/B40/B41 Australia, New Zealand: LTE-FDD: B1/B2/B3/B4/B5/B7/B8/B28/B66 LTE-TDD: B38/B40/B41 United States and Canada: LTE-FDD: B2/B4/B5/B12/B13 LTE-TDD: B14/B66/B71 | | | |
| Driving Motor | Max. Rated Speed | 0.8 m/s | 1.0 m/s | | |
| | Motor Type | Geared hub motor | | | |
| Blade Motor | Max. Rated Speed | 2800/min | | | |
| | Motor Type | Brushless motor | | | |
| Battery Pack | Battery Type | Lithium-ion battery | | | |
| | Nominal Voltage | 21.6 V DC | | | |
| | Nominal Capacity/Energy | 6 Ah / 130 Wh | 8 Ah / 173 Wh | 10 Ah / 216 Wh | 12.8 Ah / 277 Wh |
| | Battery Management System | Over-heating, short circuit, over-current, and over-charge protection | | | |
| Power Supply | Supply Unit Model | European Union and Norway: NBW32D007D0N01-EU United Kingdom: NBW32D007D0N01-UK Switzerland: NBW32D007D0N01-CH Australia, New Zealand: NBW32D007D0N01-AU United States and Canada: NBW32D007D0N01-US | | | |
| | Input Voltage | 100–240 V AC | | | |
| | Output Voltage | 32 V DC MAX | | | |
| | Output Current | 7 A MAX | | | |
| | Cable Length | 1.5 m | | | |
| Charging Station | Input Voltage | 32 V DC | | | |
| | Input Current | 7 A MAX | | | |
| | Output Voltage | 25.2 V DC | | | |
| | Output Current | 5 A MAX | 6 A MAX | 7 A MAX | 7 A MAX |
| | Indicator | LED | | | |
| Other Features | Front Wheel | Omni-directional wheel with built-in Hall sensor | | | |
| | Rear Wheel | TPU tyre with geared hub motor | | | |
| | Sensors | IMU sensor, lifting sensor, wheel encoder, bumper sensor, 3 HD camera with 300° FOV, ToF camera with 110° FOV | | | |
| Packaging | Package Dimensions | 885 x 585 x 400 mm (34.8 x 23.0 x 15.8 in) | | | |
| | Contents | Welcome card Quick Start Guide Important Information | | | |

1. Tested at a standard cutting speed with a full battery at an ambient temperature of 25°C (77°F) while mowing a fresh-cut lawn. The product can mow more per hour on open areas than on separated small lawns. When the grass is wet or long, the working capacity is smaller. The flatter the lawn surface, the larger the working capacity.
2. The noise emission declarations conform to EN 50636-2-107.

1.8 Accessories (Sold Separately)

1.8.1 Antenna Mounting Kit

In most cases, you can find a suitable location on the ground. If you need to install the antenna on a wall or a rooftop, follow these steps:

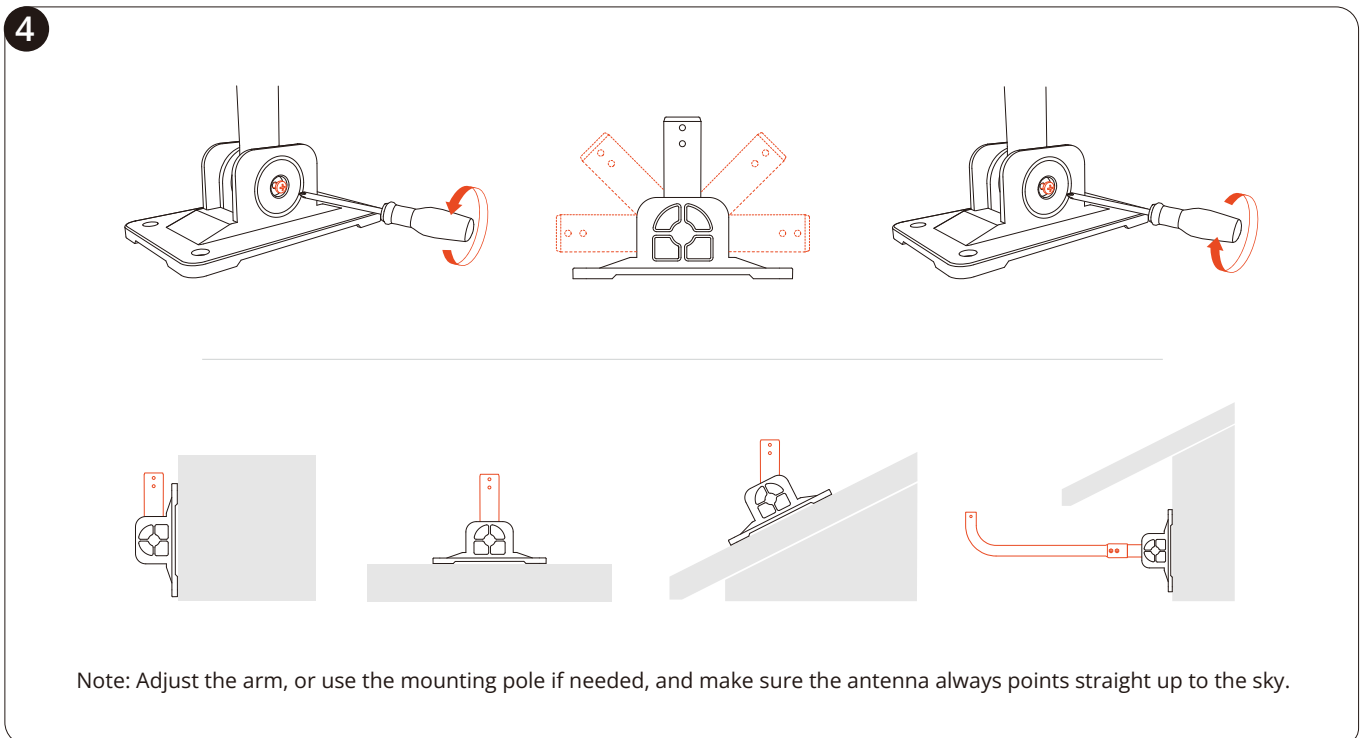
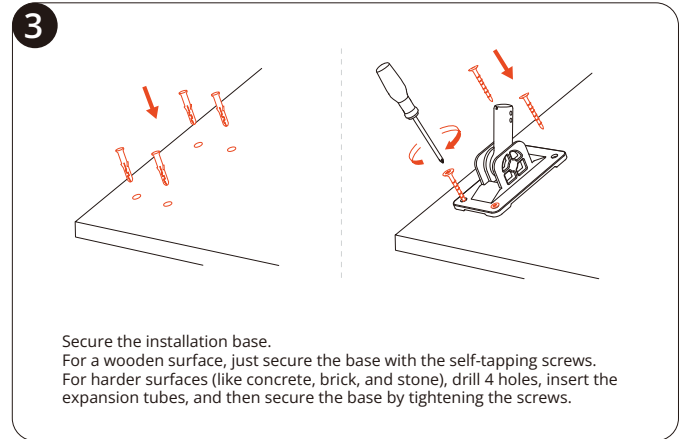
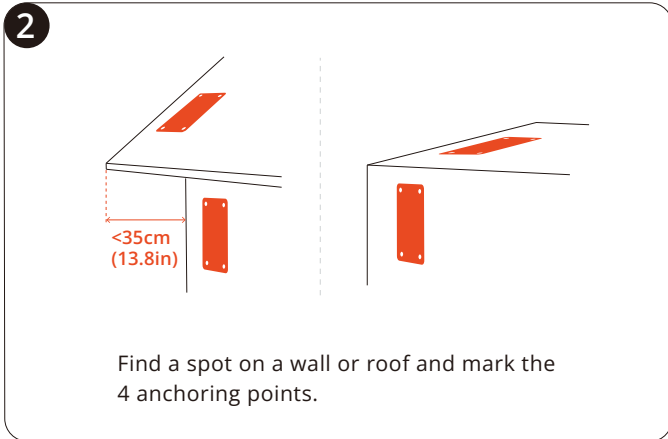
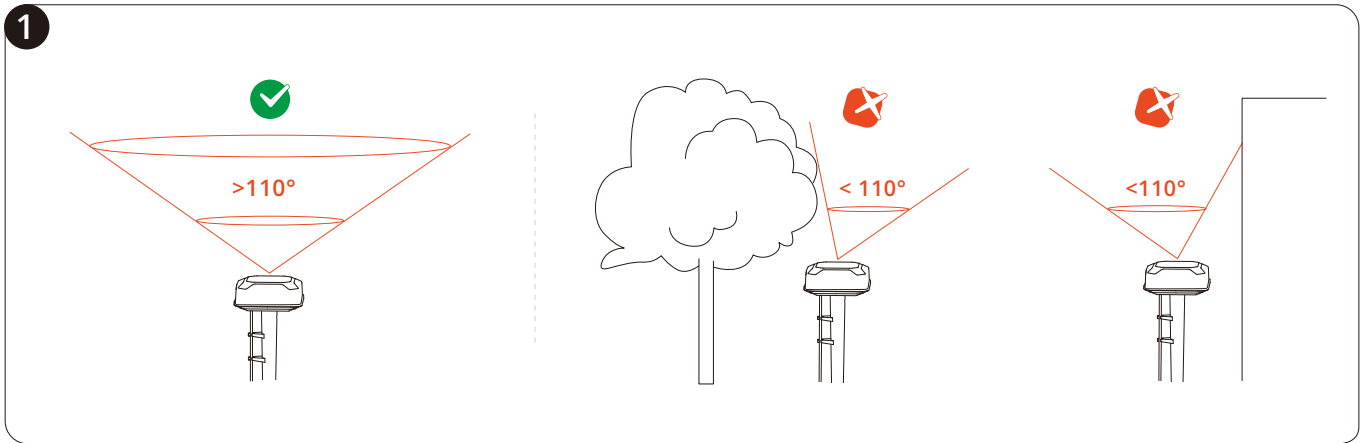

5

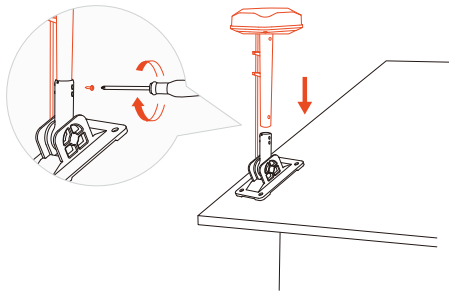

Install the antenna onto the arm.

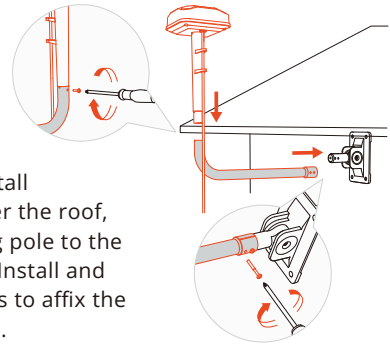

If you want to install the antenna under the roof, add the mounting pole to the arm to extend it. Install and tighten the screws to affix the arm with the pole.

6

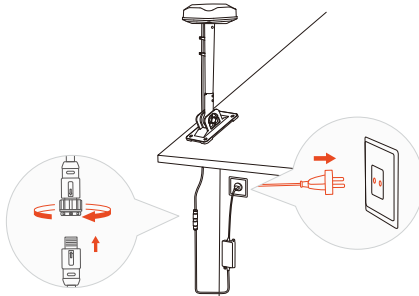

Note: Use no more than 3 antenna extension cables. Contact your local dealer for purchase.

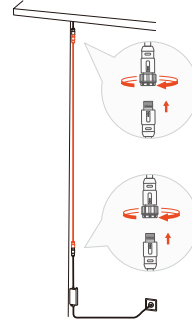

7

Hold the antenna to a place where you want to install. Check if the light on the mower turns solid green or blue (meaning the signal is strong).

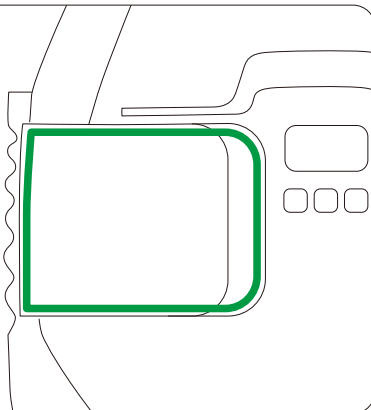

The location of the Primary Antenna affects the positioning accuracy. If you relocate the primary antenna after the map is saved, you must create a new map. Relocating the **Signal Enhancement Antenna** does not require remapping.

1.8.2 Power Supply Adapter for Antenna

This adapter is suitable when you need to install the antenna far away from the charging station, especially when there is an outdoor power outlet.

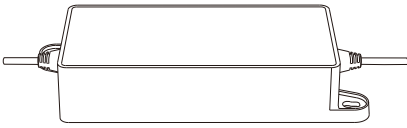

1.8.3 Antenna Extension Cable

This is an extra 10-meter antenna extension cable for power supply.

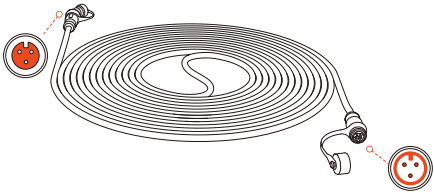

1.8.4 Signal Enhancement Antenna

This additional antenna can work together with your Primary Antenna (equipped in the box with your mower). Pair this antenna with your mower when you need to expand the GPS signal coverage.

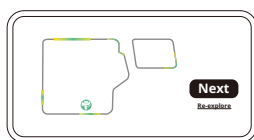
- 

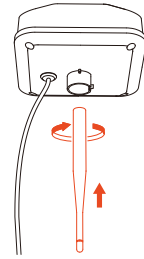
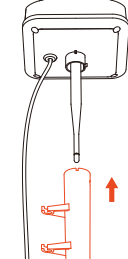
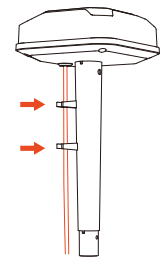
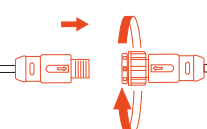
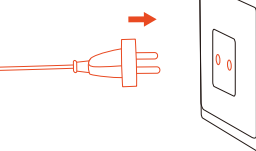
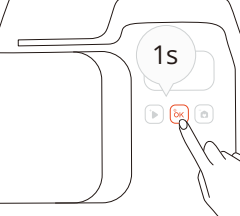
Use the Antenna Location Finder feature via the app to find out where to install.
- 
- 
- 
- 
- 
- 

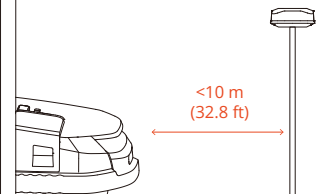
Make sure the mower is powered on.
- 

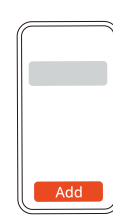
<10 m (32.8 ft)
- 

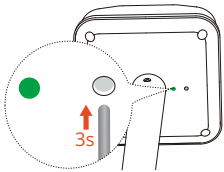
Go to EFLS 3.0 > Dual antennas > Add
- 

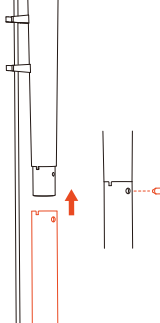
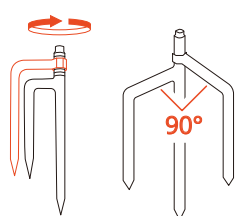
If the light doesn't flash green, press the button with a pin.
- 
- 

90°

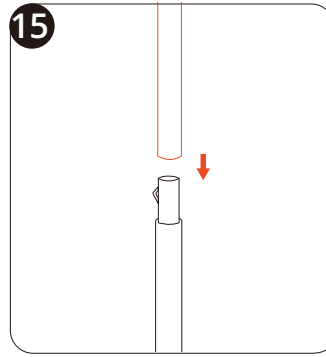
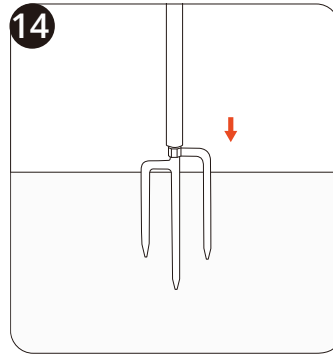
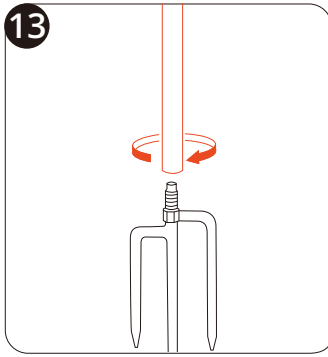

1.8.5 Navimow Garage L

The garage is fully compatible with the Navimow X3 Series, as it does not block GPS signals or network connectivity. The garage provides extra protection against sunshine and rain. The flip-up cover enables easy access to the control panel so you can operate the mower on the charging station.

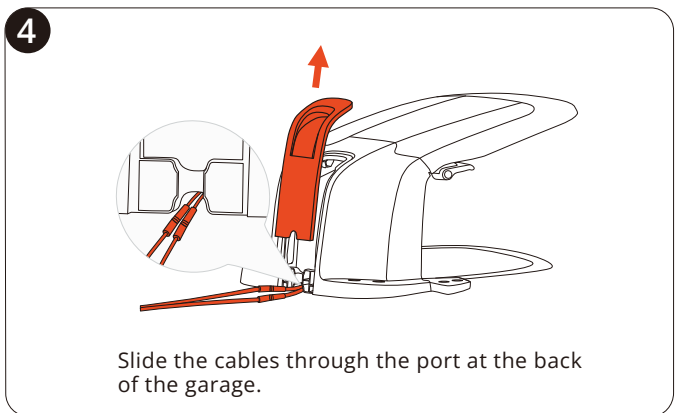
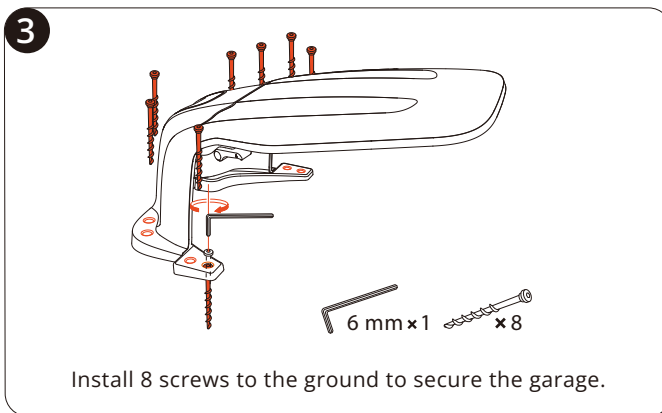
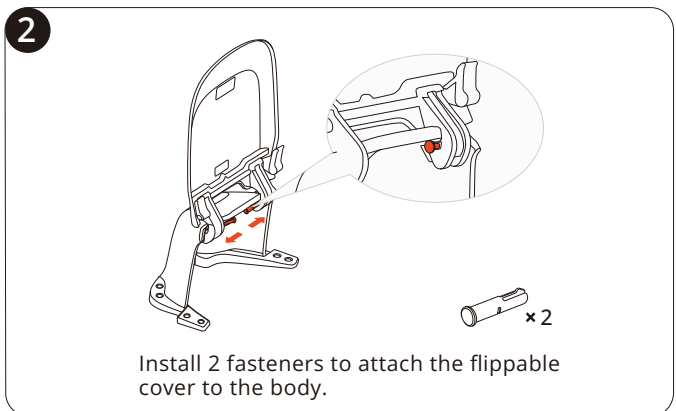
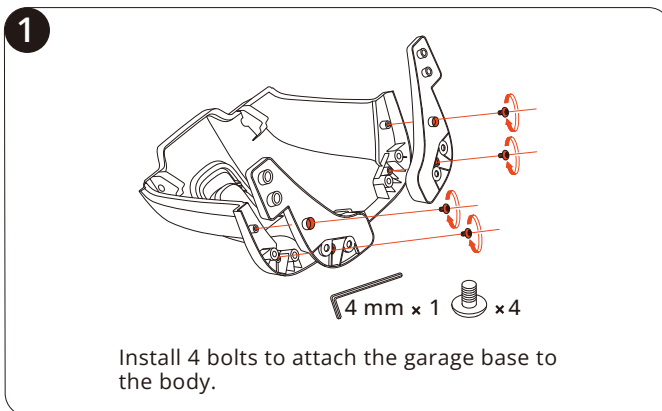

1.8.6 Blade Assembly Plus

This set of 12 blades and 15 bolts are used to replace the worn blades and bolts on your mower.



2. Installation and Mapping

2.1 Before You Start

Prepare the app



To ensure a successful setup, please scan the QR code to download the Navimow app. Alternatively, go to the Google Play Store (Android) or the Apple App Store (iOS) and search 'Navimow'. After installing the app, please register and log in.

NOTE: During use, the app will ask you for Bluetooth, GPS positioning, and Wi-Fi networking accesses when necessary. To ensure normal use, it is recommended that you enable the above accesses. For more information, please refer to our Privacy Policy. Go to Settings > APP > About > Privacy Policy.

Clear the lawn

Remove debris, piles of leaves, toys, wires, stones, and other obstacles. Make sure children and pets are off the lawn. Please cut your lawn to a maximum height of 10 cm (3.9 in).

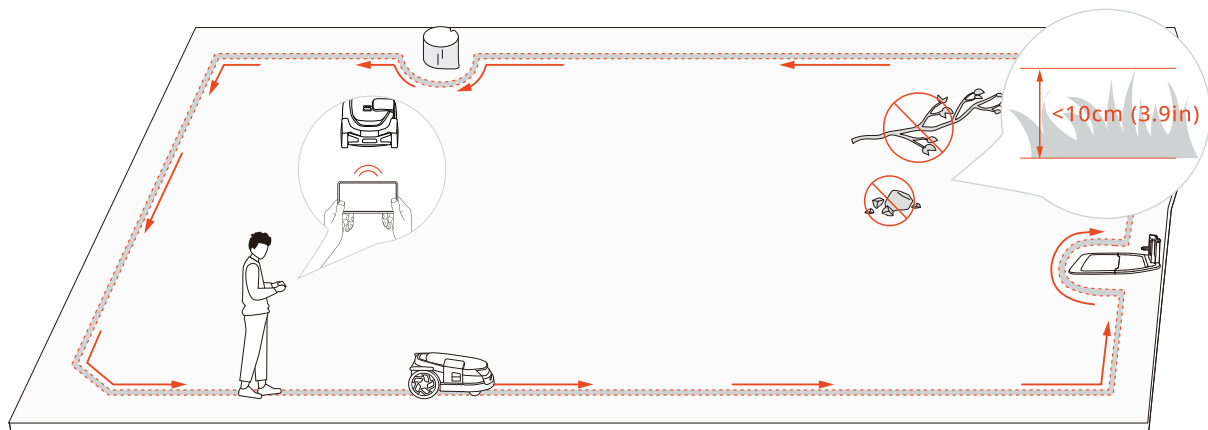

Charge the mower for the first time

A new mower may have a low battery after an extended storage duration. Fully charge the mower before the first use. Place the mower in the charging station. Make sure the charging strip on the mower and the contact strip on the charging station are in good contact.

2.2 Activate the Mower

Press and hold the OK button for 1 second to power on the mower. Pair your mower with a smartphone via Bluetooth. Connect to a 4G network or Wi-Fi network. Follow the instructions via the app for other settings.

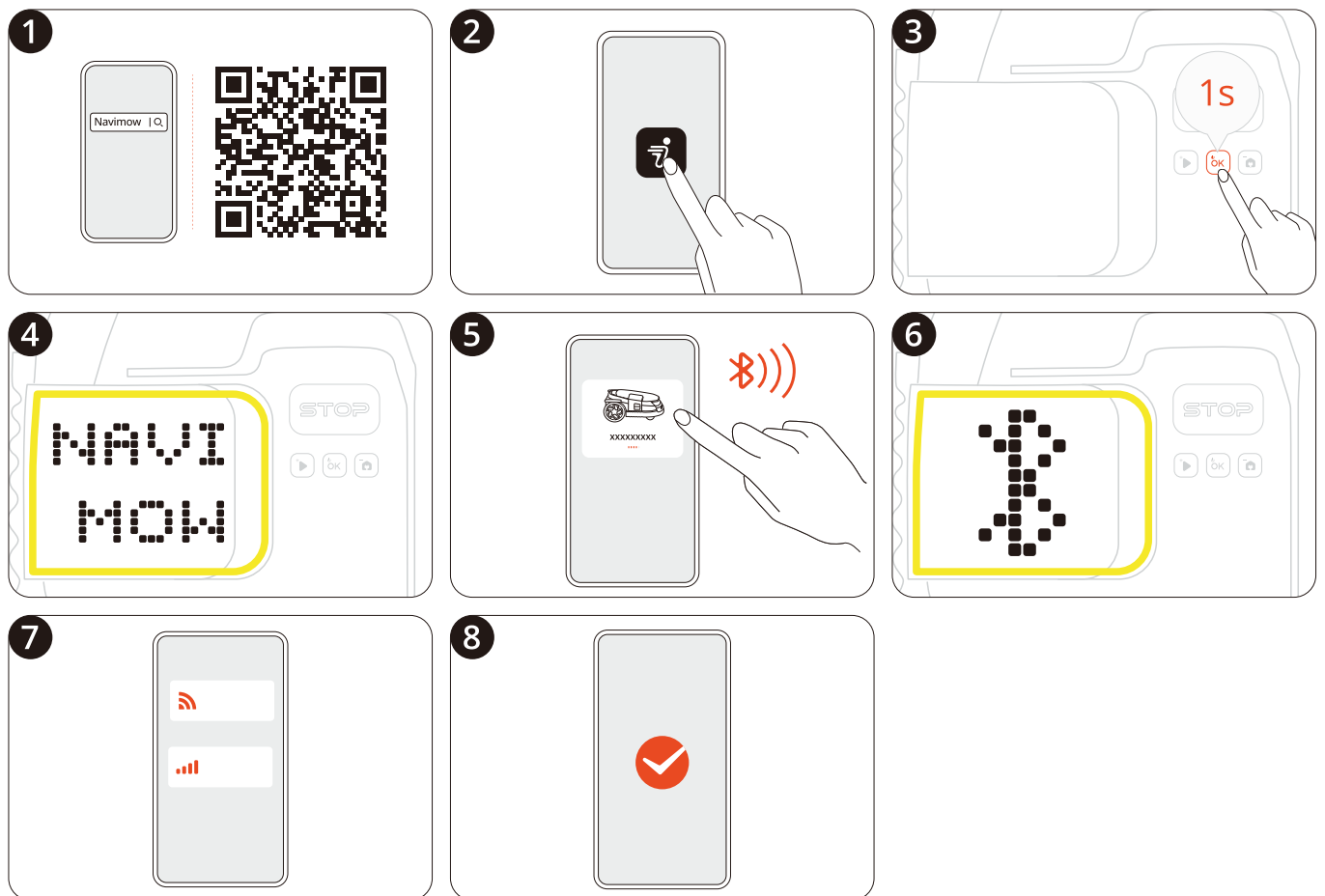
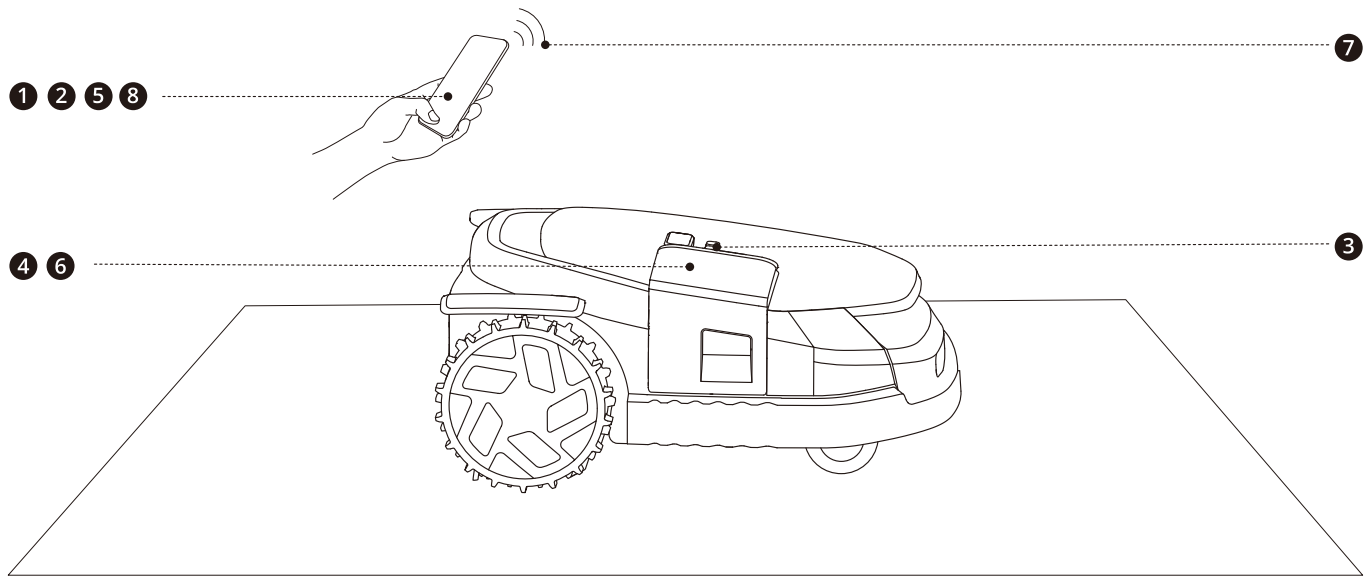

2.3 Find Locations

For the X3 mowers, you can choose to install just one antenna, which is the Primary Antenna included in the box.

Or you can buy an additional antenna called the Signal Enhancement Antenna to expand the GPS signal coverage:

- If you own a house with a front yard and a backyard, it is recommended to install two antennas, one at the front, the other one at the back. When the mower works across the whole area, the positioning can always be stable with each antenna covering the front and the back.
- If your lawn is too large for a single antenna to cover the entire mowing area, it is recommended to install two antennas. This way, with each antenna covering a maximum area of 200-meter radius, dual antennas can work together to enhance the overall GPS signal.

The charging station should be placed near the Primary Antenna.

2.3.1 Basic Principles

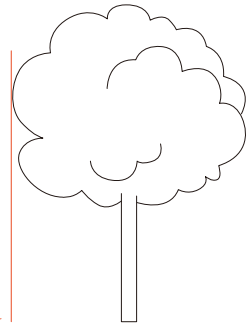
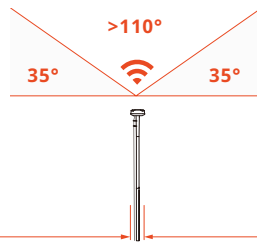

21

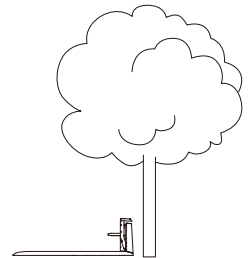
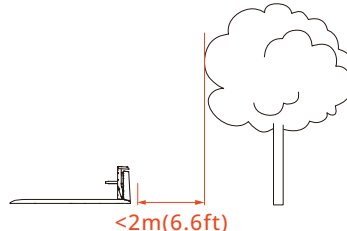
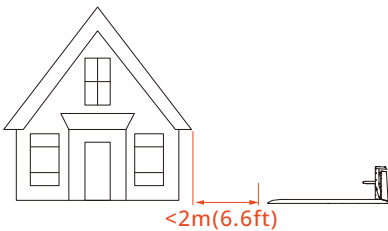
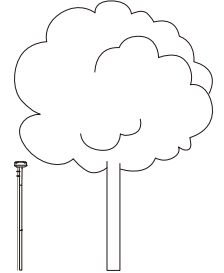
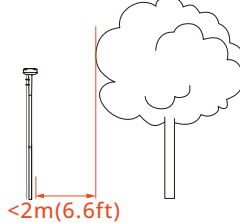
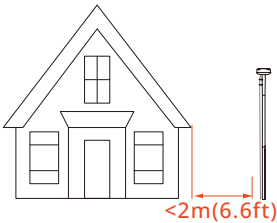

2.3.2 Find Locations using Antenna Location Finder

When you are unsure about the specific locations for installing antennas and charging stations based on positioning principles, you can use the Antenna Location Finder to assist you. Depending on the number of antennas you want to install, and get recommendations for locations to install the Primary Antenna, the Signal Enhancement Antenna, and the charging station.

Go to Settings > MOWER > Maintenance & Tools > Antenna Location Finder, and follow the instructions below:

1. Guide the mower to explore along the edges of the lawn, so it can collect data on the surrounding environment.
2. Choose desired locations for the antennas and charging stations. The recommendation is given based on the GPS signal strength, helping you to identify the best spots.
3. Follow the recommendation given by the Antenna Location Finder to install your antenna and charging station, or adjust their locations if needed.

2.3.3 Verify Locations using Satellite Signal Analyzer

When both the mower and the antenna are connected to the same satellite, it's called a 'Co-visible Satellite'. For accurate positioning of the mower, it requires at least 5 Co-visible Satellites. Having more Co-visible Satellites means the positioning is better.

The Satellite Signal Analyzer helps you to check if your antenna and the charging station are installed at a proper location. Go to Settings > MOWER > Maintenance & Tools > Satellite Signal Analyzer.

If the result says there are enough Co-visible Satellites, it means that the location of the charging station and the antenna are OK. If the result says there aren't enough Co-visible Satellites, it means you need to move the charging station and the antenna to different places. After that, check the number of Co-visible Satellites again.

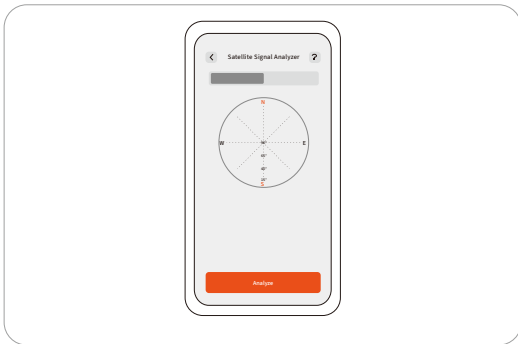

2.4 Install GNSS Antenna and Charging Station

2.4.1 Install Primary Antenna and Charging Station

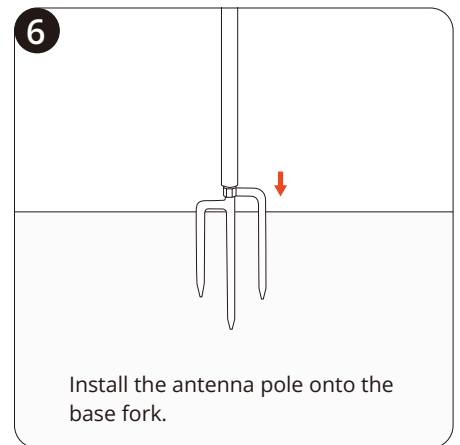
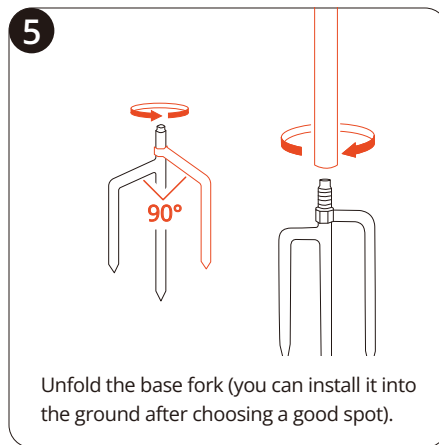
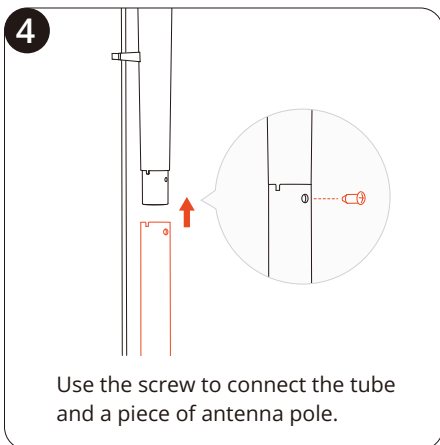
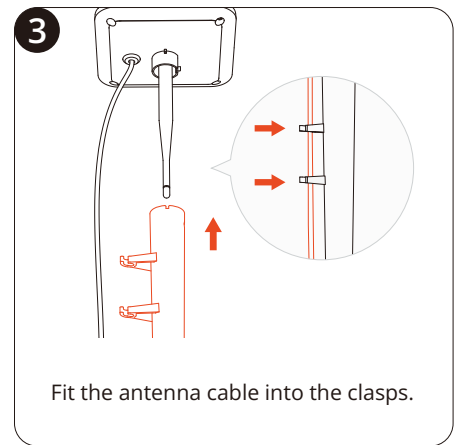
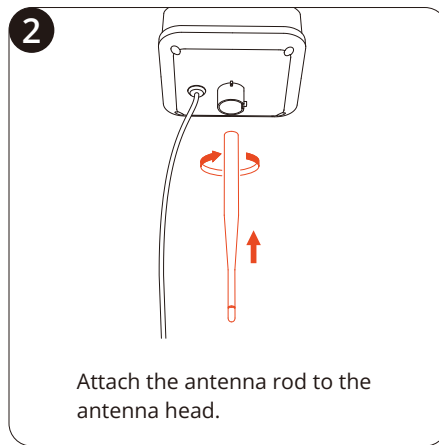
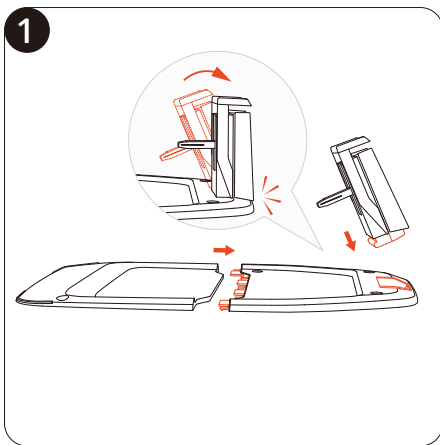
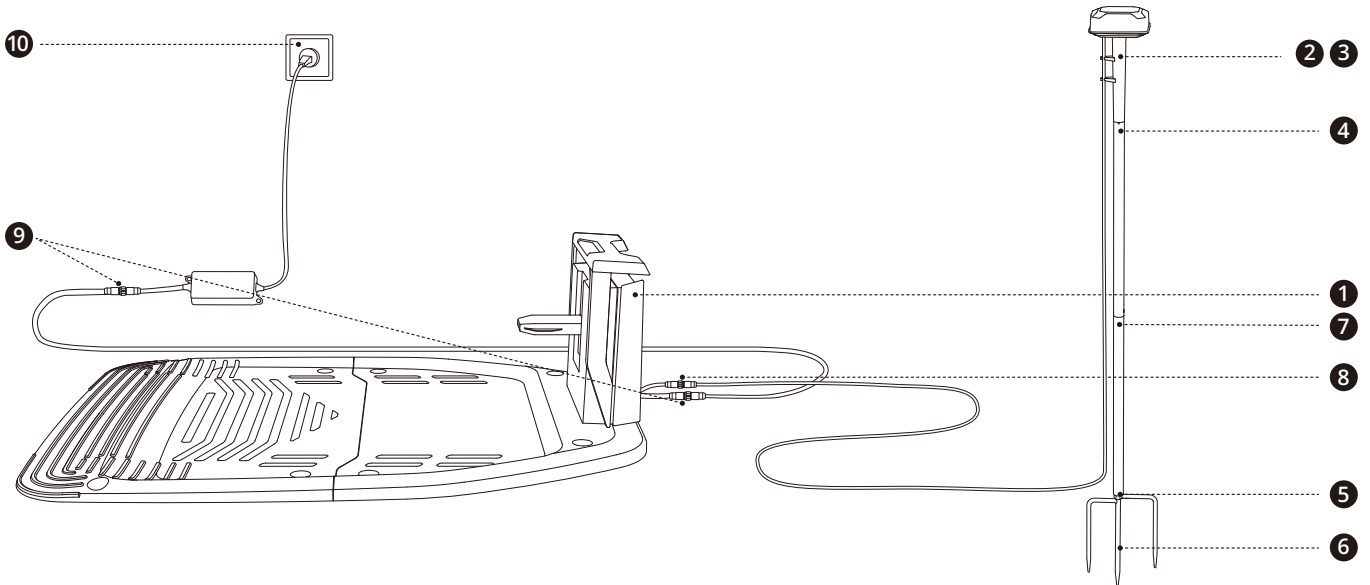

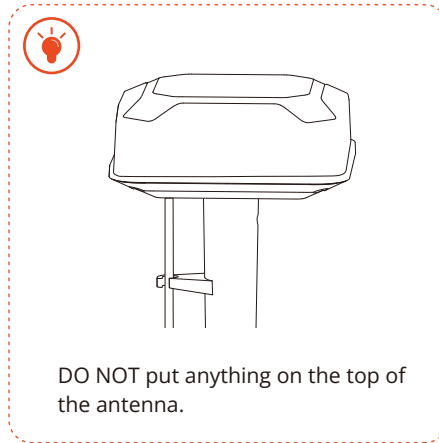
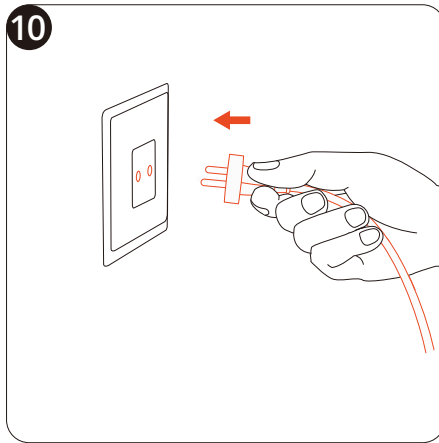
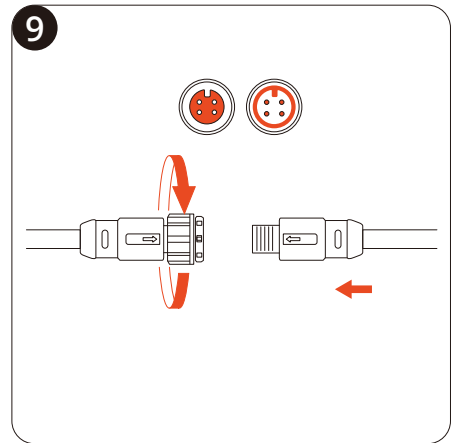
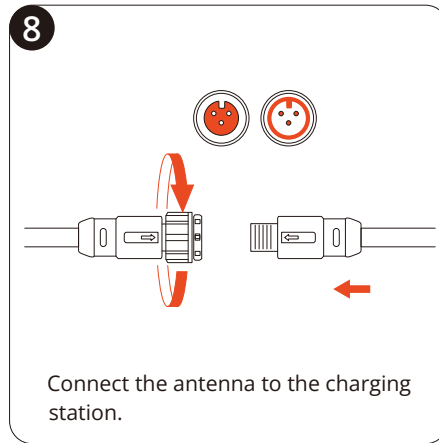
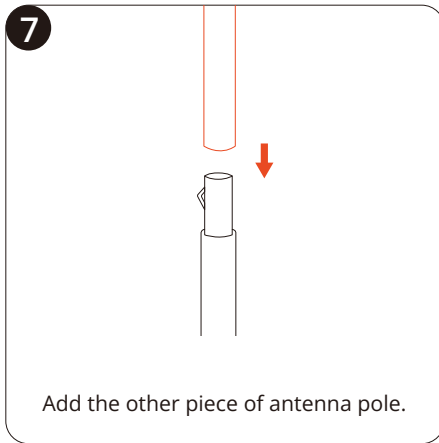

2.4.2 Pair Signal Enhancement Antenna (Optional)

Repeat the steps in 1.8 to assemble the Signal Enhancement Antenna. Plug in a separate adapter for the antenna (12V 1A) to a power outlet.

To pair the Signal Enhancement Antenna with your mower, follow the instructions below:

NOTE: Make sure the mower is already powered on and the Signal Enhancement Antenna is plugged in.

1. Place the mower within 10 meters of the antenna.
2. Add the Signal Enhancement Antenna from Settings > MOWER > Advanced features > EFLS 3.0 > Dual antennas > Add.
3. Follow the guidance via the app, and press the button at bottom of the antenna head. The light on the left side will turn green, meaning the pairing is successful.

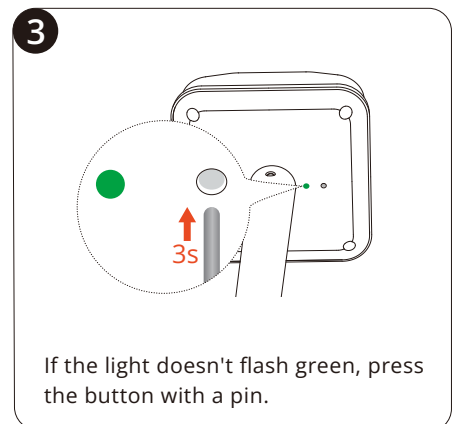
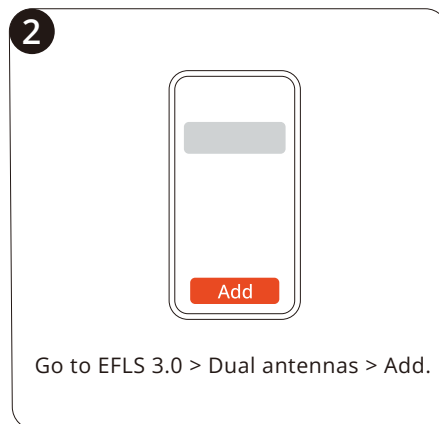
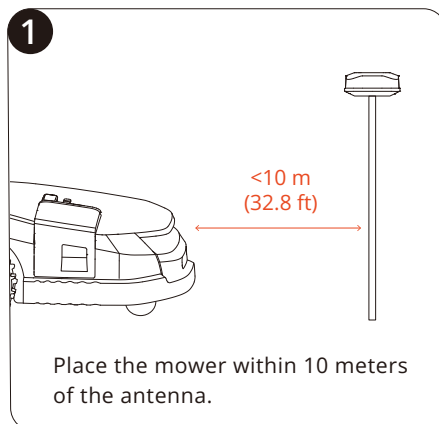

2.4.3 Do the Auto-check

1. Push the mower into the charging station.
2. Please wait until the light on the mower becomes green.
3. (Optional) If the light does not turn green, go to Settings > MOWER > Maintenance & Tools to verify locations using the Satellite Signal Analyzer. For more information, see 2.3.3 Verify Locations using Satellite Signal Analyzer.

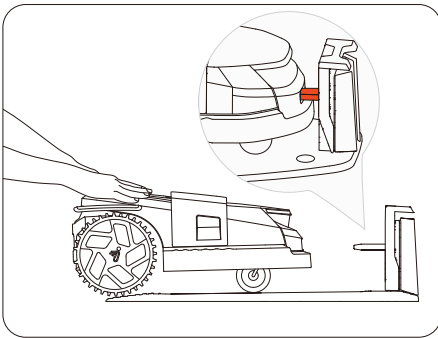

2.4.4 Secure Locations

If the auto-check is successful, you can go ahead and secure the location of the charging station. If not, you need to relocate the antenna and the charging station.

NOTE: Make sure the cables are not placed on the lawn or anywhere the mower may pass over. Otherwise, the cables may get damaged.

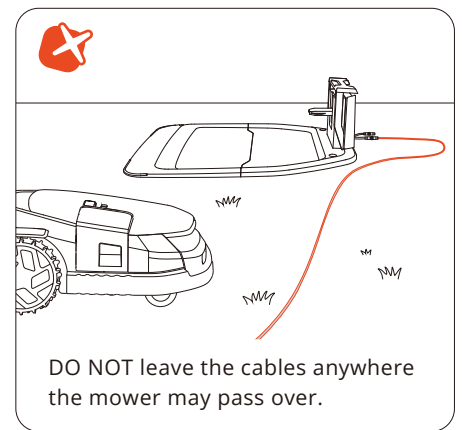
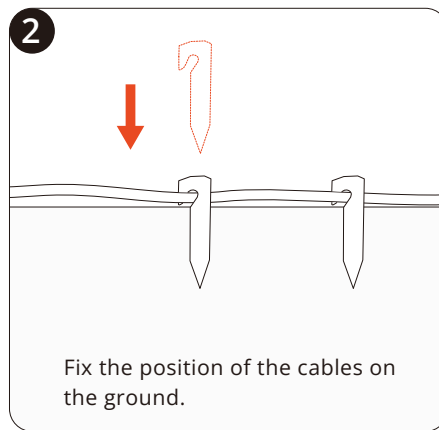
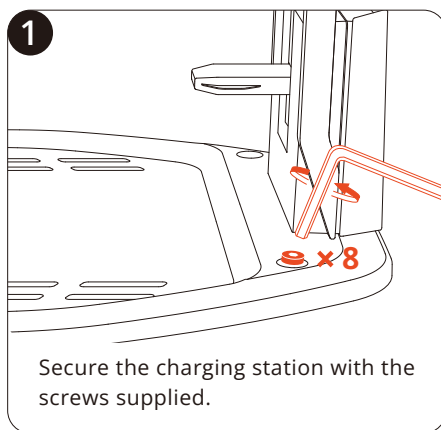

2.5 Upgrade to the Latest Firmware

Navimow uses Over-The-Air (OTA) to upgrade the firmware. To fully experience Navimow, prior to use, please upgrade to the latest firmware. Go to Settings > MOWER > My devices > Firmware version.

After activating the mower, maintain the network connection state, follow the guidance in the pop-up window, and wait for 10-30 min to automatically complete the firmware upgrade depending on the network conditions. During this process, please do not power off or perform other operations. You can start using it after the app prompts that the upgrade is successful.

2.6 Map out the Work Area

2.6.1 Map out the Boundary

A boundary defines the edge of a mowing zone.

If you have more than one lawn or a large lawn that needs to be divided into several parts, create multiple zones and connect them with channels.

1. Make sure the mower is powered on. With Bluetooth connection, your phone will connect to the mower automatically.

NOTE: If the mower is in lock status, you must enter the PIN code before operating the mower.

2. Tap 'Create a map' to start mapping.

3. Calibrate the mower to ensure accurate positioning.

4. Find a proper starting point along the edge of your lawn. Keep within 6 m (19.7 ft) of the mower during the mapping process.

5. Walk along the edge.

Angle: Make sure to follow a straight line with a smooth turning angle of no less than 90°.

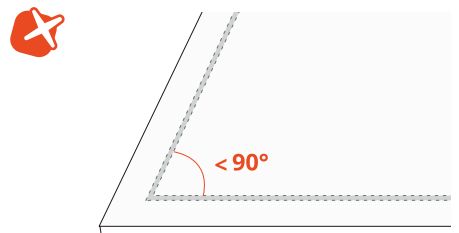
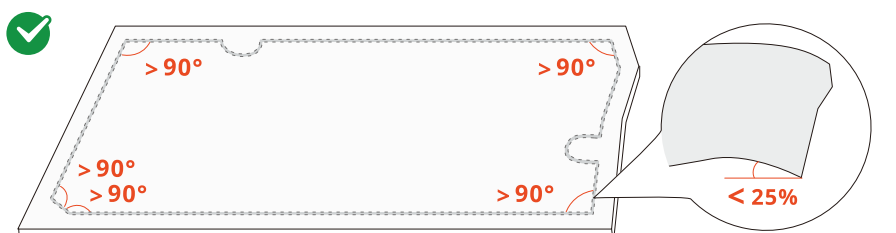
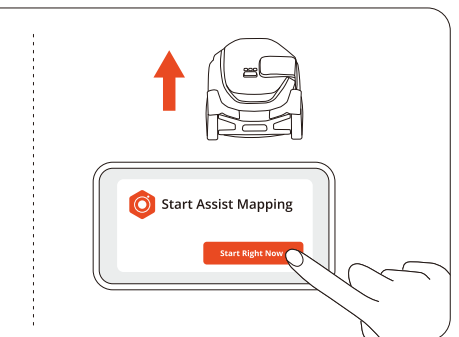
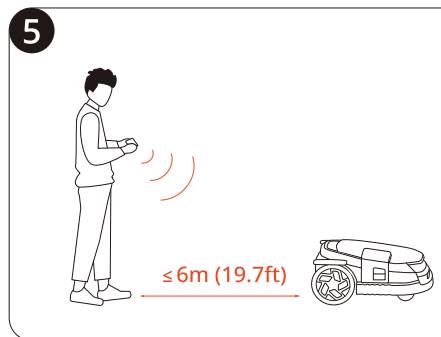
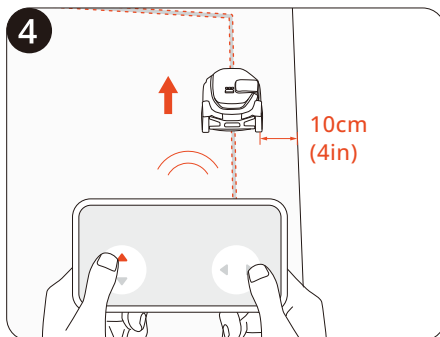
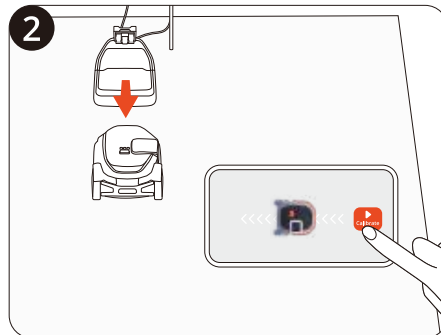
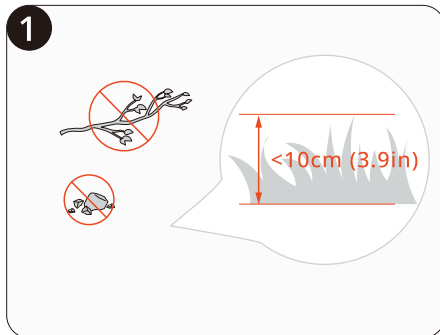
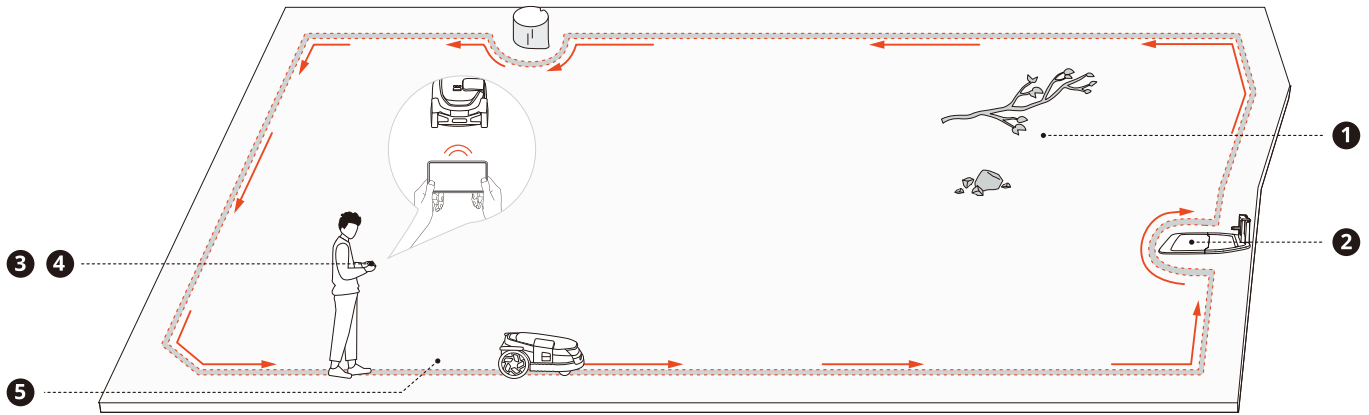

Boundary Type

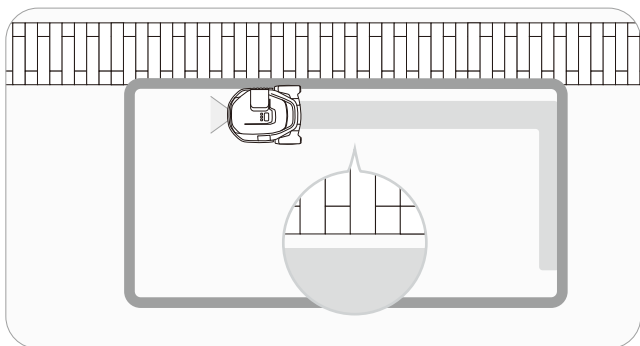

Standard Boundary: By choosing the Standard Boundary  icon, the mower will stay within the defined boundary while mowing along the edges. You don't need to precisely guide the mower along the edges, as the camera sensors will automatically collect data of the environment. You can also turn on Assist Mapping, as the camera sensors will automatically identify the edges of the lawn, so the mower can navigate itself.

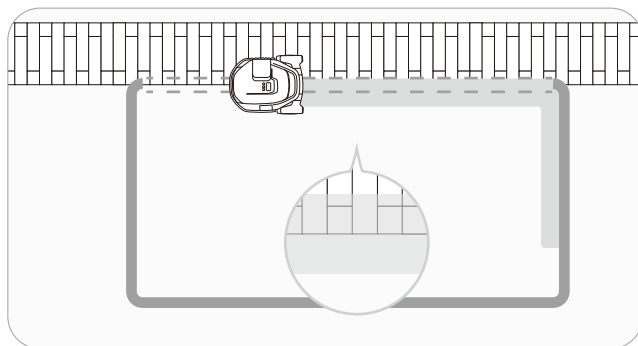

Ride-on Boundary: By choosing the Ride-on Boundary  icon, the mower can ride on the edge in order to fully trim the grass right up to the non-grass area during mowing. The pathway or the pavement should be at the same level with the lawn.

NOTE: Ensure the height between the grass and the non-grass area is less than 1 cm (0.4 in).

Assist Mapping

The camera sensors on the mower capture the physical boundary of the lawn and Assist Mapping will be triggered. Therefore, the mower can create boundaries automatically by navigating along the edges on its own, making mapping easier. Remote control the mower towards the edges of the lawn. When the camera detects clear lawn edges, you can decide whether to start Assist Mapping.

When the icon  or  on the upper right corner flashes, tap it and start Assist Mapping.

27

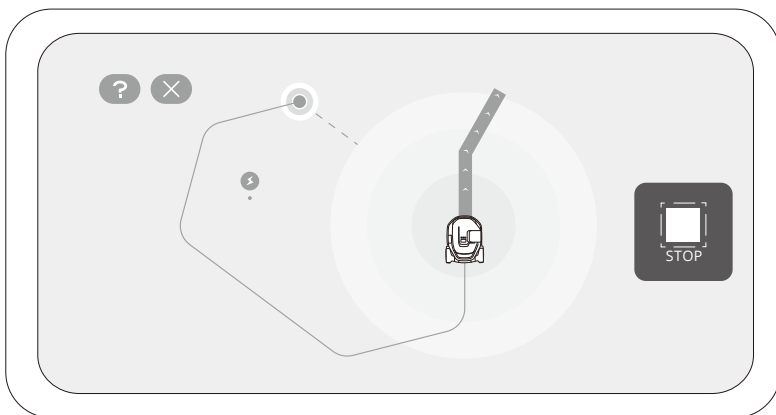

- Keep your phone active and avoid switching to other apps.
- Stay within 6 m (19.7 ft) of the mower during Assist Mapping.
- If the mower behaves abnormally, you can stop Assist Mapping at any time and manually control the mower.

Isolated Zone

When you have created a zone that is neither connected to the charging station nor via other zones, this zone becomes an isolated zone.

You can only start mowing by pressing the MOW button on the mower, and carry it back for recharging.

NOTE: Mowing schedules are not supported for isolated zones.

28

2.6.2 Create an Off-limit Island (BioLife Island)

The camera sensors can identify objects on the lawn and the mower can avoid bumping into them. To protect both your mower and objects on the lawn, you can lay borders for objects or areas that you don't want the mower to enter. For example, a flowerbed, a ditch, a hole, lawn decorations, a pond, a pool, sprinkler heads, or emerged roots. If you have recently installed a trampoline or grill on the lawn, you can also set it as an off-limit island to protect it.



Follow the instructions in the app. When you need to cancel the area (like when you remove the trampoline from the lawn), just delete it via the app.

An off-limit island is also called a BioLife island. You can also set up BioLife islands for places where the grass is left to grow naturally, creating a playground and a home for wildlife like bees, butterflies, and hedgehogs.

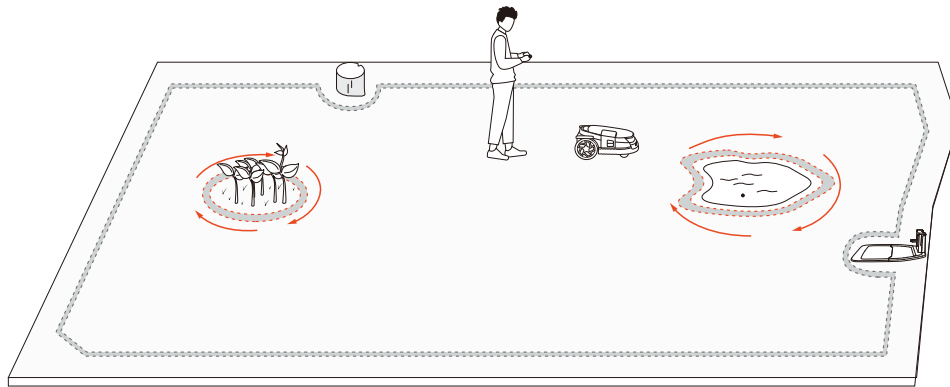

NOTE: Make smooth turning angles when setting the islands. The angles should not be less than 90°. You also need to walk along the edge when setting the island. For instructions, see 2.6.1 Map out the Boundary.

2.6.3 Create a Channel

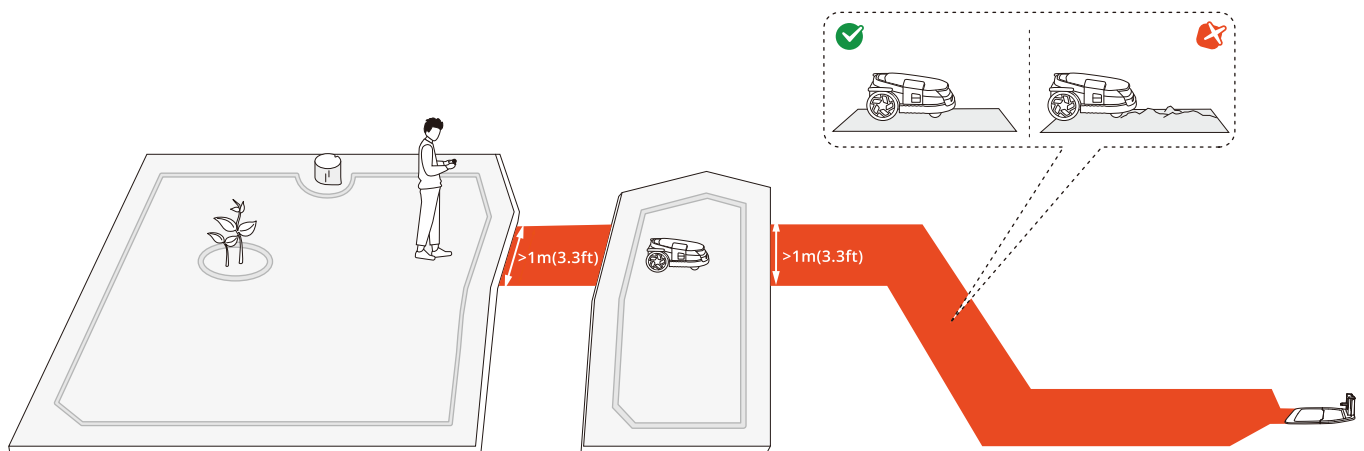

A channel can be created to connect two separate zones or to connect the edge of a lawn to the charging station. To improve obstacle avoidance inside a channel, you can enable 'Channel Obstacle Avoidance' from Settings > MOWER > Advanced features > VisionFence.

NOTE: The channel that you choose to let the mower pass through should be wider than 1 m (3.3 ft).

2.6.4 Create a VisionFence-off Zone

A VisionFence-off zone is a place where the mower automatically turns off the camera used for obstacle avoidance, so the mower will directly pass through instead of turning away.

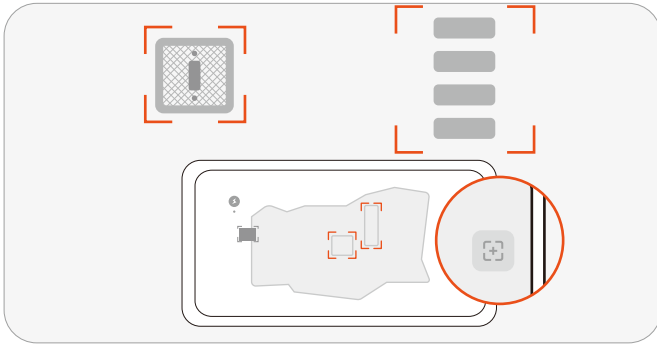

If you need the mower to pass through flat non-grass areas to achieve a thorough cut, you can set up a VisionFence-off zone. These areas can be, for example, stone roads or utility holes, where the visual detection causes the mower to avoid. Follow the instructions in the app. You can adjust the size of a VisionFence-off zone, move it to another place, or delete it.

2.6.5 Create a Doodle

A doodle is a fun design or pattern that you can create on your lawn using your mower. By choosing a design (a logo or a combination of letters and numbers) and a location, the mower will leave that part of the lawn uncut. Once the rest of the lawn is mowed, the doodle will be visible.

29



Follow the instructions in the app. You can decide how long the doodle will stay before the mower mows over it completely once the active days (up to 30 days) are over.

3. Daily Use

3.1 Mow

3.1.1 How Does Navimow Mow

Mowing along the boundary and around off-limit islands

Your mower mows along the boundary and mows around off-limit islands when it starts a mowing task.

If the surroundings are complex, to avoid risks, you can disable 'Edge Mowing' from Map management > Edit > Edge Mowing for each zone.

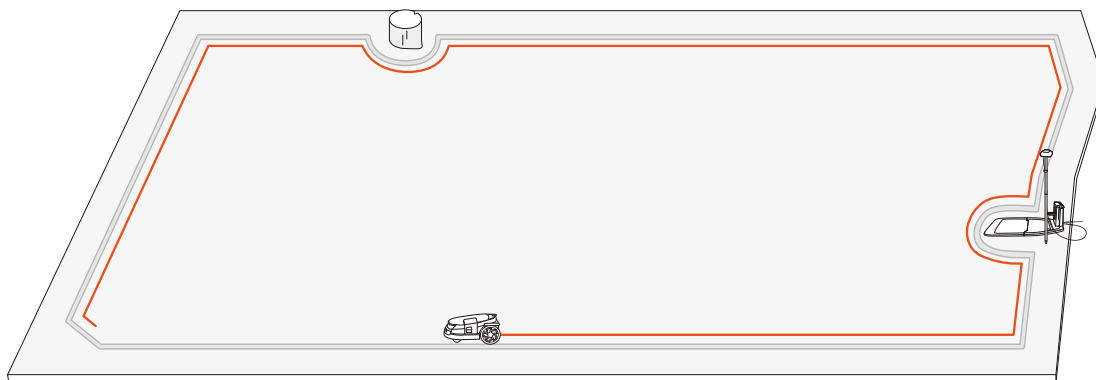

Mowing with systematic patterns

Inside the work area, the mower will mow the lawn along a planned path calculated by an algorithm for maximum efficiency. The mower can change its mowing directions according to your choices. This avoids repetitive mowing tracks. To customize mowing directions for each mowing zone, see Customize mowing directions in 3.1.2 Manage Multiple Zones.

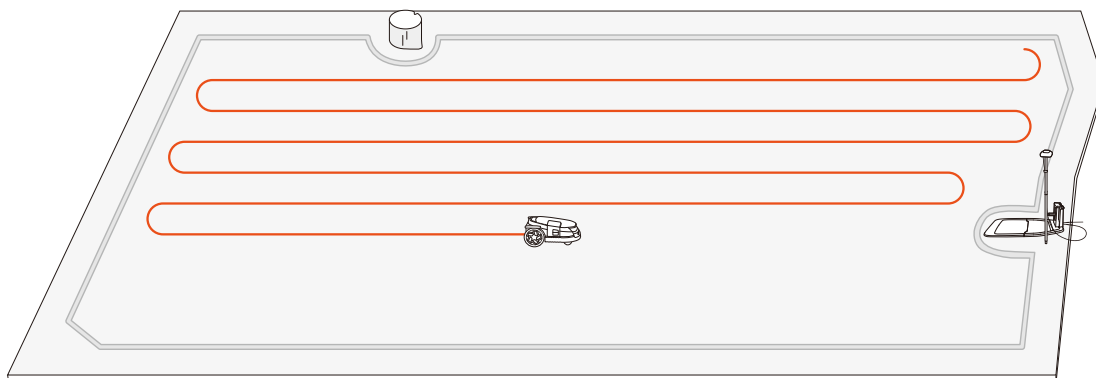

3.1.2 Manage Multiple Zones

You can create multiple zones for your map, each zone with its own unique name and a customized mowing direction, and mowing schedule.

For manual mowing, you can select to mow all zones or only some of them. For scheduled mowing, you can set up schedules for all or selected zones.

A zone is automatically created after the boundaries of a work area is mapped out. You can continue to create multiple zones and connect them with channels. For instructions, see 2.6.3 Create a Channel.

Rename the zones

1. Tap to select a zone.
2. Tap 'Edit' and customize settings for the selected zone.
3. Tap the 'Rename' icon to set a name for the zone.

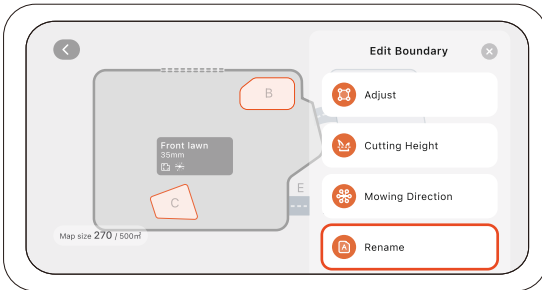

Customize mowing directions

The mower can automatically change its mowing direction according to your choices from Map management > Edit > Mowing direction. You can choose one or more directions so that mower changes the mowing direction every time it finishes a round of mowing.

31

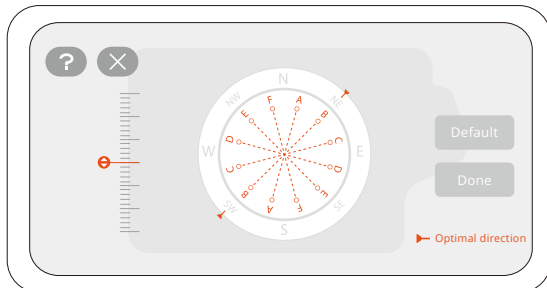

Create or modify mowing schedules

1. Go to Settings > MOWER > Mowing > Mowing schedule.
2. Select a day to set up a schedule.
3. Set the start time and end time of the schedule.
4. Select which zone(s) to apply the schedule.
5. Tap 'Confirm' to save the settings.

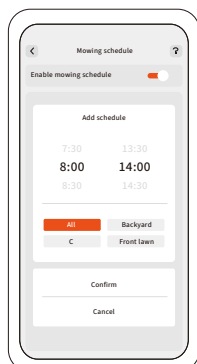

Enable or disable mowing schedules

You can disable the mowing schedules if you don't want the mower to follow the schedule.

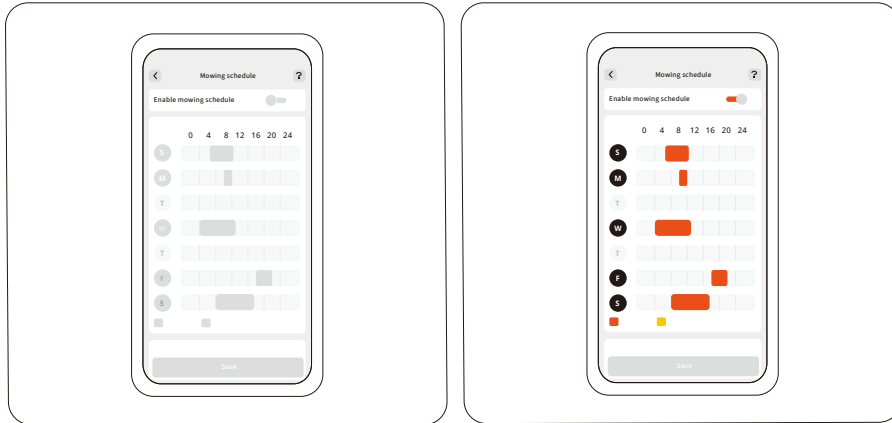

Enable or disable mowing cycle

When disabled, if the mowing progress in the selected zones reaches 100%, the mower will stop mowing and return to the charging station even if the scheduled end time has not yet arrived.

When enabled, if the mowing progress in the selected zones reaches 100%, the mower will start a new round of mowing and keep mowing until the scheduled end time arrives.

Split and merge zones

To split a zone into smaller ones, manually control the mower to cut a zone into two. Go to the 'Map management' page, select a zone, and find 'Split' in 'Edit'. The new zones will follow the same settings as the old one.

To merge several zones into one, go to the 'Map management' page, select a zone, find 'Merge' in 'Edit', choose an adjacent zone, and merge them. You can only merge two zones at a time.

3.2 Navimow App

3.2.1 Introduction

The Navimow app is an important part of Navimow, you can use the app to:

1. Bind and activate the mower.
2. Create a map (work area) with multiple mowing zones.
3. Check the status and work progress of the mower, remotely control the mower to start, stop, or return to the charging station, etc.
4. View and change mower work settings (map management, mowing schedules, etc.).
5. View and change mower security/function settings (Mowing at night, Reset PIN code, Anti-theft, etc.).
6. Update firmware, and change network connection.
7. Unbind and retain or clear user data.
8. Get user materials and after-sales support via Live Chat.

3.2.2 Download, Register, Log in

1. Search and download the Navimow app through the Apple APP store or Google Play Store.
2. Register and log in to your account.
3. Turn on the Bluetooth on your phone and make sure your phone has a network signal.

NOTES:

1. If you have registered an account through other services of Segway-Ninebot, you can log in to the Navimow app with the account and vice versa.
2. If you deactivate your Navimow account, all data related to Segway-Ninebot will be deleted.
3. During use, the Navimow app will ask you for Bluetooth (iOS/Android), location (iOS/Android), and Wi-Fi access (Android). To ensure normal use, please grant the above accesses.
4. If you use Navimow with an iOS mobile device, when configuring the mower's Wi-Fi network for the first time, please make sure that your mobile phone is connected to the same Wi-Fi network.

3.2.3 Update Navimow app and Firmware

To experience the latest features and updates, always keep your Navimow app up-to-date. You will receive a notification to remind you when there is a new version of the app.

To manually check firmware updates, go to Settings > MOWER > My devices > Firmware version.

To upgrade the firmware successfully, the following conditions need to be met:









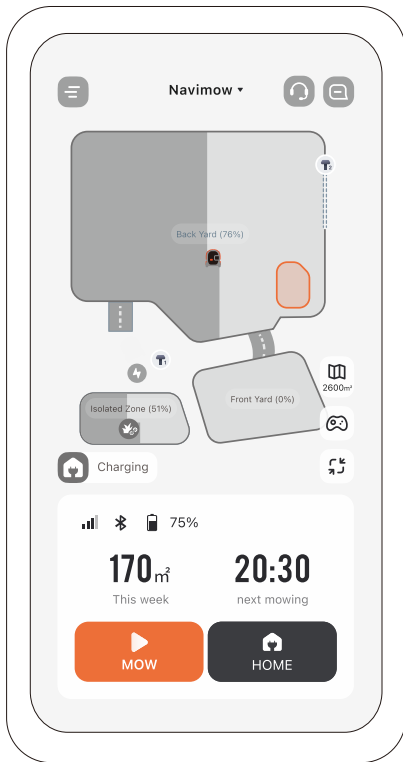

- The mower is in the charging station.
- The mower is connected to a network and the signal is strong (through 4G or Wi-Fi).
- The battery power is more than 20%.
- There is no mowing task scheduled in the next hour.

For more information about upgrading firmware, see 2.5 Upgrade the Mower to the Latest Firmware.

3.2.4 App Home Page

The home page shows the status of the mower, the status of antennas, work progress, and mowing tasks. You can choose to view the work area of all zones or selected zones, start or pause mowing tasks, and send the mower home. You can also go to the Live Chat, the notification page, and the settings page by tapping the icons on the top of the home page.



| | | |
|----------------------------|---|---|
| Map management |  | Navigates to the Map management page |
| Battery level |  | Battery level and charging status |
| Antenna |  | 1 indicates the Primary Antenna and 2 indicates the Signal Enhancement Antenna |
| Bluetooth |  | Bluetooth connected. When disconnected, tap to reconnect. |
| Connectivity |  | Displays the network that the mower is connected to (Wi-Fi or cellular), and the signal strength |
| Mower status |  | Ongoing tasks/Upgrading firmware/Charging/On the way back to the charging station/Unknown status/Task stopped/Malfunctioning/Not enough battery |
| |  | Map accuracy is improving or has been improved/Poor positioning/Offline/Initializing |
| |  | Mowing delayed by various weather conditions |
| Switch to other devices | Navimow ▾ | Tap to switch to another mower of yours and rename your mowers from Settings > MOWER > Basic info |
| Settings and Notifications |  | Tap to view the settings/notifications of the mower and the app |
| Live Chat |  | Entrance to the Help Center where you can find user materials and Live Chat for questions or requests |

3.3 Mower Settings

3.3.1 Add, Switch, Unbind Devices

You can add multiple mowers from Settings > MOWER > My devices > Device management and switch to another mower by selecting another serial number (SN) in the list. When unbinding the mower, you need to verify your identity by entering the hidden characters of your email address or phone number.

You can choose to retain or clear your user data after unbinding the mower.

3.3.2 Network Settings

You can manage the network used by Navimow on the Network management page. On the Wi-Fi settings page, you can view the currently connected Wi-Fi network or reconnect to the Wi-Fi. You can choose to only use 4G, or to only use Wi-Fi, or to let the system automatically choose the network type for you depending on the connection status.

3.3.3 Time Zone and Country

You can manually select your local time zone and country or region so that the mowing schedules can follow your local time. You can enable the Daylight Saving Time mode if your region follows this practice. This way, the mower can automatically adapt to your local time during summer and winter.

3.3.4 Sound and Light Settings

The sound effects are enabled by default. When you disable it, the mower will not make any sounds of notification during mowing and charging.

3.3.5 Voice Feedback (Text-to-Speech)

The voice feedback feature allows your mower to communicate with you using a selected voice or tone. When enabled, the mower will report status updates in the chosen language. Go to Settings > MOWER > My devices > Sound and light > Voice feedback.

3.3.6 Device Sharing

You can share your mower with others from Settings > MOWER > My devices > Device management > Device sharing. This feature allows you to invite up to 5 users who have registered on the Navimow app to share your mower. Just send them an invitation, which will expire in 7 days if not accepted. Once they accept, they will have full access to manage the mower. Both you and your invitees can cancel the sharing at any time.

3.3.7 Dual Antennas

If you have purchased the Signal Enhancement Antenna, you can pair it with the mower from Settings > MOWER > Advanced features > EFLS 3.0 > Dual antennas. For instructions, see 1.8 Accessories (sold separately).

Locate: If you are not sure if the antenna is the Primary Antenna or the Signal Enhancement Antenna, tap 'Locate'. The light on the antenna will flash green, indicating which one you are looking for.

Synchronization: The dual antennas work together as a positioning system, meaning they are synchronized and the positioning accuracy becomes better.

Delete: If you no longer use the current Signal Enhancement Antenna, you can delete it. Note that the Primary Antenna cannot be deleted.

Online/Offline: Either antenna may occasionally go offline, but they will be synchronized automatically as the mower mows across the lawn.

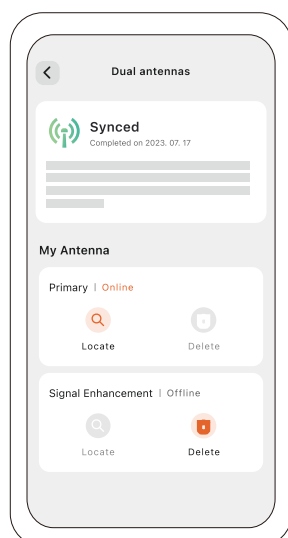

3.4 Safety Features

3.4.1 Reset the PIN Code

You can reset the PIN code in Settings > MOWER > Safety features > Device lock > Reset PIN code.

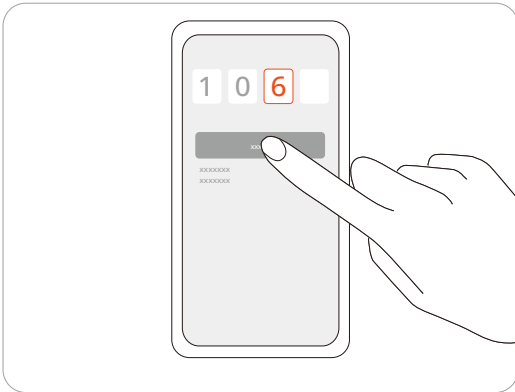

3.4.2 Enable and Use Anti-theft

The Anti-theft feature can precisely locate your mower and prevent incidents such as mower theft. You can choose to enable the alarm when the mower is being lifted and when the mower crosses over the virtual boundary.

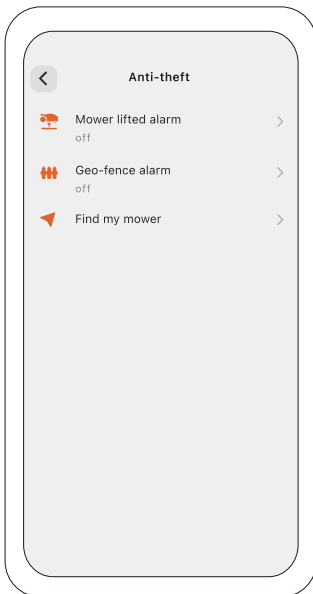

35

Mower lifted alarm

This alarm alerts you if your mower is being lifted off the ground for a few seconds. When enabled, you will hear an alarm and receive a notification on your app. To stop the alarm, enter the PIN code directly on the mower.

If you need to carry the mower to a different location, it is recommended to connect your phone via Bluetooth beforehand to prevent false alarms.

Geo-fence alarm

This alarm alerts you if your mower crosses a designated boundary. When enabled, you will hear an alarm and receive a notification on your app. To stop the alarm, enter the PIN code directly on the mower.

When the geo-fence alarm is enabled, you can adjust the geo-fence radius and check Navimow's location on the map in real-time. If the mower runs out of battery and powers off on the way back to the charging station, you can find where it stopped via the app.

NOTES:

1. If the Anti-theft feature is enabled, you need to enter PIN code on the mower before powering it off.
2. The Anti-theft feature can only be used under a 4G network. Make sure your 4G service has not expired.

3.4.3 Device Lock

The safety lock and child lock are used to ensure the safety of the mower and prevent unintended operations. To enable them, go to Settings > MOWER > Safety features > Device lock.

Safety lock

The safety lock prevents accidental activation of the mower when it needs to be carried or cleaned. Press MOW+HOME for more than 3 seconds to lock the mower. When locked, the mower remains inoperable until you unlock it with the PIN code.

Child lock

The child lock prevents children or pets from accidentally operating the mower by touching the buttons while it is working or on standby.

By enabling it from Device lock > Child lock, the buttons on the mower won't respond to pressing or touching. Mowing and other settings can still be adjusted on the app.

3.5 Advanced Features

3.5.1 VisionFence Settings

Avoid obstacles in channels

You can enable the Channel Obstacle Avoidance switch and the mower can "see" the surroundings and intelligently passes through by actively avoiding obstacles or other objects that are distinct from the ground. Even when the GPS signal is poor around the channel, the mower can still manage to pass through with visual detection.

Animal friendly

You can enable 'Animal friendly' mode so the mower will stay far away from pets and small animals in its vicinity by adjusting its path in real-time. Go to Settings > MOWER > Advanced features > VisionFence > Animal friendly. This avoids accidental harm to wildlife such as hedgehogs, and reduces the chance of alarming or disturbing nearby pets.

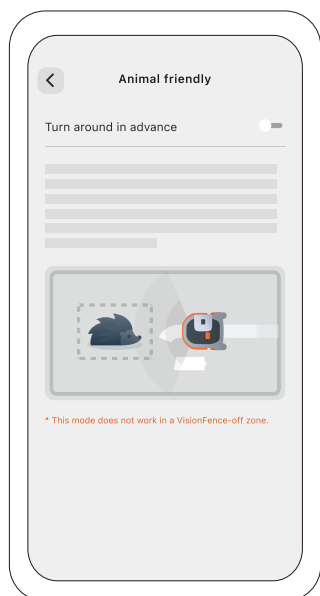

3.5.2 Weather Adaptive

The mower can react to real-time weather info and adapt its mowing schedules, either stopping the current task or delaying the upcoming tasks. You can set how you want the mower to react under these weather conditions: rain, snow, hot weather, frost, and strong wind.

To ensure a healthy lawn and a longer work life of your mower, go to Settings > MOWER > Advanced features > Weather adaptive to customize settings for each type of weather.

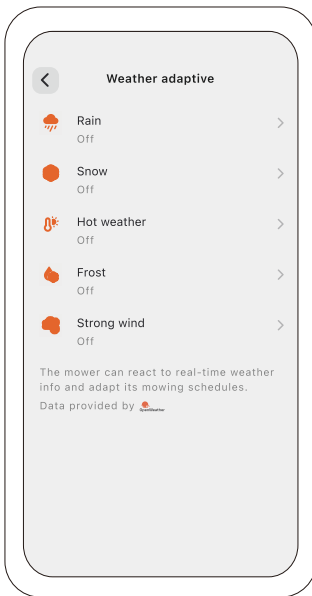

3.6 App Settings

37 Go to Settings > APP to browse and adjust the Navimow app-related settings.

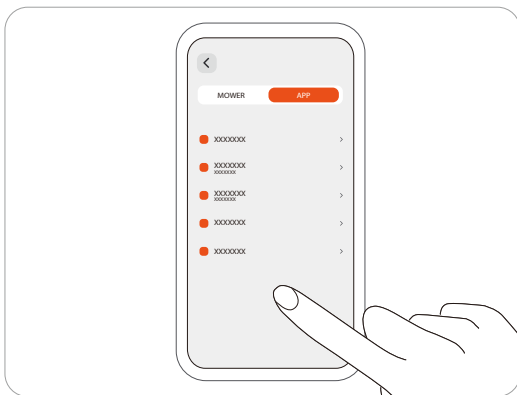

Account and security

You can check your bound email address or mobile number, change the password, download the data, and delete your account.

Language

You can set the language to the one that you need. Currently, 22 languages are supported, which are English, German, French, Dutch, Italian, Swedish, Norwegian, Finnish, Danish, Portuguese, Spanish, Czech, Slovak, Polish, Estonian, Lithuanian, Latvian, Bulgarian, Hungarian, Croatian, Romanian, and Slovenian.

Help and feedback

You can view the latest user materials, tutorial videos, FAQ, and contact us for support via Live Chat here.

Units

You can switch between the metric units and the imperial units here.

About

You can view the current app version, the latest User Agreement and Privacy Policy here.

Log out

You can log out of your account here, and your data will not be deleted after logging out.

4. Maintenance

To achieve better mowing results and increase the service life, be sure to keep the mower clean and the blades in good condition. Inspection and maintenance should be carried out by an adult every week. Any damaged or worn parts should be replaced. **DO NOT perform maintenance when wearing open sandals or barefoot. Always wear long trousers and work shoes when servicing the mower.**

4.1 Cleaning

Use a soft brush or cloth to clean the exterior of the mower thoroughly. **DO NOT** clean with alcohol, gasoline, acetone, or other corrosive/volatile solvents. These substances may damage the appearance and internal structure of your mower.

For proper docking, periodically inspect and clean the charging station from debris and mud. Make sure all connecting parts of the charging station, the extension cable, and the power supply are not blocked.

A. Chassis and cutting disc

If the chassis and cutting disc are dirty, use a brush or a water hose to clean. **DO NOT** use a high-pressure washer. At the same time, make sure that the cutting disc rotates freely and the blades can pivot freely.

CAUTION: High-pressure water can leak into the sealings and damage electronic and mechanical parts.

B. Blade fender

Check the blade fender regularly. If mud, grass clippings or other objects gather on the blade fender, remove them with a dry brush or scraper.

C. Front wheels (universal wheels)

Inspect and clean universal wheels regularly. If the wheels are stuck, clean off the mud and lubricate the wheels.

D. Rear wheels

Check and clean the rear wheels regularly. Remove grassing clippings or other objects. If the wheels are stuck with mud or dirt, wash them with a water hose.

E. Camera lens

Check and clean the camera lens regularly. A stained camera lens may affect the performance of the mower.

F. Charging port

Check if grass clippings or dirt is stuck inside the charging port, and clean them in time. Otherwise, the mower cannot be charged due to poor contact.

WARNING

- Before cleaning, make sure the mower is powered off.
- Before turning the mower upside down, it must be powered off.

4.2 Replace Blades

The blade disc automatically changes its rotation direction multiple times during mowing to prevent excessive wear on one side. If the mower is used on a regular basis, it is recommended to replace the blades and screws every 1–2 months to ensure safety and better mowing results. Replace all 6 blades and their screws at the same time for a safe cutting system.

Wet grass is more likely to stick to the blades and the bottom part of the mower, which can affect its performance and require more frequent cleaning. For optimal results and to maintain your lawn's health, it is best to avoid mowing during heavy rain or when the lawn is excessively wet.

It is normal for grass clippings to accumulate on the blades during mowing. The design of the blades allows them to continue rotating smoothly around the screws, even when small amounts of clippings or debris are present. This occasional buildup of clippings should not negatively impact the mower's ability to effectively cut grass. The mower is designed to perform its function despite minimal clippings collecting on the blades over time.

While grass clippings can be removed when replacing the blades if desired, immediate action is not required unless an excessive amount of clippings are stuck on the blades.

⚠WARNING

- Wear protective gloves when you inspect or replace the blades.
- DO NOT use an electrical screwdriver to install or loosen the cutting disc. Only use the right type of screws and original blades as approved by Navimow. Blade model: X3A06E.
- DO NOT reuse the screws. Doing so can cause serious injury.

How to replace the blades

1. Turn off the mower.
2. To avoid scratching, place the mower on a soft and clean surface in an upside-down position.
3. Use a cross-tip screwdriver to loosen the screws.
4. Remove the anti-clogging cutting disc, the screws, and the blades.
5. Fasten the anti-clogging disc and the new blades with the new screws (Torque: 1 N·m). Make sure the blades can pivot freely.

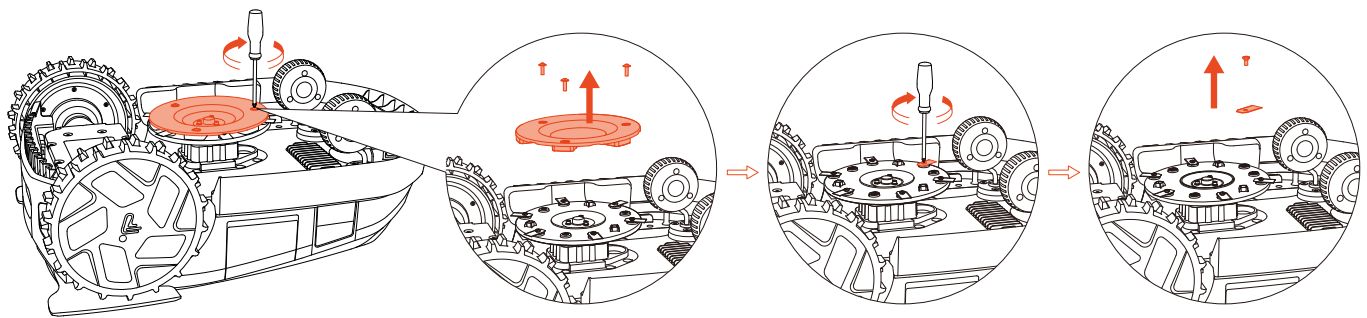

NOTE: After fastening the blades and screws the blades will still seem loose. This is normal as the blades need to spin during mowing. The blades are intentionally designed to rotate freely when attached to the blade disc. During mowing, the spinning blade disc generates centrifugal force, which causes the blades to point outward. This outward orientation allows the blades to effectively cut grass.

4.3 Key Parts Maintenance

Key parts of the mower, including blades, the chassis, the charging port, and the camera lens, require regular maintenance to ensure the optimal performance of the mower.

Go to Settings > MOWER > Maintenance & Tools > Parts maintenance and check the working hours of these key parts. This can be used as a reminder to clean and maintain these key parts.

4.4 Transportation

To protect the mower, use the original packaging for long-distance transportation. Before lifting, moving, or transporting the product, turn it off. Handle with care and avoid violent force, such as throwing and heavy pressure. Never pick up or carry the mower while the motor is running.

How to move or lift properly

Carry the mower by the handle, with the blade disc facing away from your body.

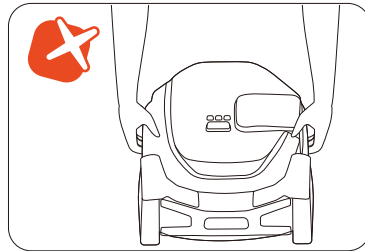
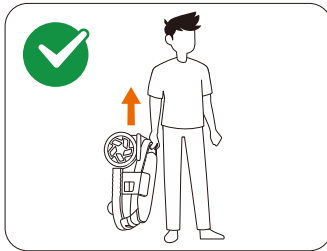

CAUTION:

To avoid damage to the mower and/or the charging station, DO NOT lift the mower by the handle when it's parked in the charging station. Pull off the mower from the charging station before lifting the mower.

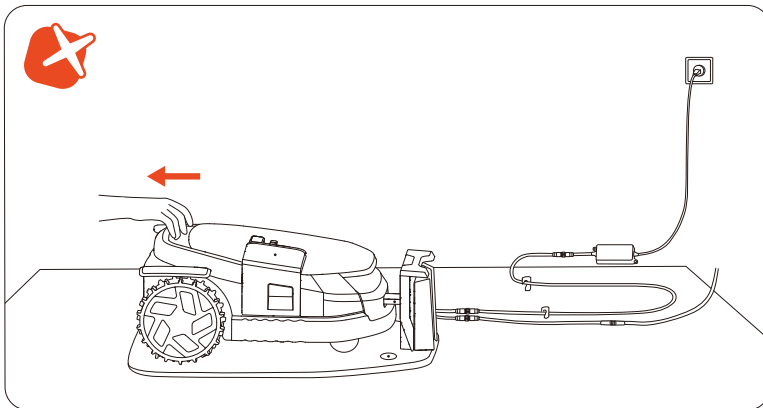

4.5 Battery

- Power off the mower and charge its battery to 85% or higher before storage to avoid over-discharge and damage to the electrical components. Charge the mower every 120 days for long-time storage.
- Battery damage caused by over-discharge will not be covered by the Limited Warranty.
- DO NOT use or store the battery under extreme temperature conditions, i.e., above 50°C (122°F) or below -20°C (-4°F).
- Temperature protection will be activated at 0°C (32°F)/53°C (127°F), the battery won't be charged unless the temperature reaches 3°C (37°F) or above/reduces to 49°C (120°F) or below.
- When the battery temperature is too high or too low, the mower will not start mowing. You will also receive a push notification in the Navimow app.

NOTE: The battery life depends on how often the product is used and the total working hours. When the operation time is significantly shorter than usual per full charge or the lawn is not well-cut, consider contacting the after-sales service to replace the battery.

4.6 Power Supply

- Disconnect the power supply:
 - Before clearing a blockage;
 - Before checking, cleaning, or working on the machine;
 - After striking a foreign object to inspect the machine for damage.
- Regularly examine the cord, plug, enclosure, and other parts. If any damage or signs of aging are found, stop using immediately.

WARNING

- DO NOT operate a damaged power supply. If the supply cord is damaged, it must be replaced by the manufacturer, its service agent or similarly qualified persons in order to avoid a hazard. If the extension cable is defective, please replace it with the 10-meter long cable as approved by Navimow.
- DO NOT connect a damaged cord to the power supply or touch a damaged cord or extension cable before it is disconnected from the power socket. Damaged cords can lead to contact with live parts.
- DO NOT use the power supply with any other product or battery, otherwise there will be risks of personal injury, fire or electrical shock. Product safety cannot be guaranteed with batteries other than the original ones.
- DO NOT charge when the battery is leaking.
- Keep the extension cable away from moving hazardous parts to avoid damage to the cords which can lead to contact with live parts.

Recommendation

Connect the mower and/or its peripherals only to a supply circuit protected by a residual current device (RCD) with a tripping current of no more than 30 mA.

4.7 Storage

- Before storage, power off the mower and charge its battery to 85% or higher to avoid over-discharge, which will cause permanent damage.
- Store in a cool and dry place indoors. Exposure to sunlight and extreme weather (both hot and cold) will accelerate the aging process of the components and may permanently damage the battery.
- Keep the mower, charging station, and power supply away from heat sources (such as stoves, radiators, etc.) or chemicals. Protect the power supply from moisture and keep it in a well-ventilated place.

WARNING

When there is a risk of a thunderstorm, unplug the power supply from the power socket. Disconnect all cables and wires connecting to the charging station. Reconnect when there is no longer a risk of thunderstorms.

4.7.1 Winter Storage

For optimal performance and longevity, it is recommended to store your Navimow during winter months when it will not be in use. By properly storing your Navimow, you can protect it from harsh winter conditions and ensure its functionality when spring comes. Cold weather, including freezing temperatures and snow, can damage sensitive components of the mower. Follow the steps below:

Put the mower in storage

1. Pull the mower off the charging station. Make sure the mower has at least 85% battery left.
2. Power off the mower.
3. Disconnect the power supply and the antenna.
4. Put your protective gloves on and remove the blades with caution.
5. Turn the mower upside down and clean it with a brush.
6. Use a water hose to wash away the dirt and leave the mower to get dry.

Put the charging station and Navimow Garage L in storage

1. Uninstall Navimow Garage L from the charging station and put the garage away.
2. Press the button on the charging tower to remove it from the charging station, and put the charging tower in storage.
3. Leave the base plate at its original location.

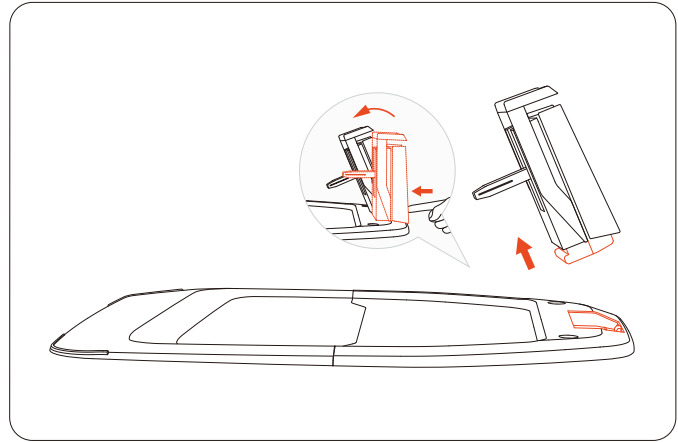
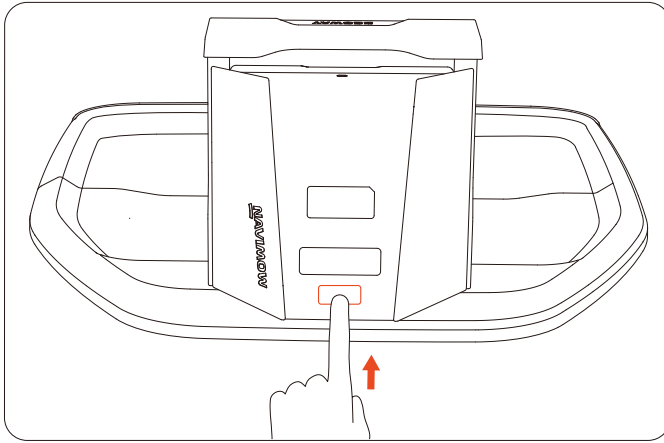

Put the antenna in storage

If the antenna is installed on a wall or roof, use a plastic bag or a cover to cover up the antenna. If the antenna is installed from the ground, follow the steps below:

1. Remove the antenna and the pole. Keep the base fork at its place.
2. Put away the cable for the antenna.

4.7.2 Spring Restorage

To restore your Navimow and all its installations in spring, follow the steps below:

1. Remove all coverings from the mower.
2. Ensure that the charging station is clean and free from dirt. Re-install the charging tower on the base plate.

NOTE: The difference between the installed position and last year's position should not exceed 5 cm.

3. Reconnect the cables that were disconnected during the winter. Check the cables for any damage or breaks and repair as needed.

NOTE: Check the blades for sharpness and replace them if necessary. Check and clean the camera lens to ensure proper functionality.

4. Finally, power on the mower and test if the mower is bound to the app and works properly.

4.8 Recycling and End-of-Life Disposal

DO NOT treat this product as domestic waste. For recycling information, contact your domestic waste service, your municipality, or point of sale.

⚠ WARNING

DO NOT dispose of this product in a landfill, by incineration, or by mixing with household trash. Danger or serious injury can occur because of the electrical components.

5. FAQ & Troubleshooting

If you encounter any product or app-related problems, common issues and questions, check out the FAQ articles from 'Service and Support > Help Center' on the Navimow official website (<http://navimow.segway.com>) or from the 'Help and feedback' section from the Navimow app.

6. Important Information

6.1 Europe

6.1.1 EC DECLARATION OF CONFORMITY

EC Declaration of Conformity for Robot Lawn Mower

Manufacturer: Willand (Beijing) Technology Co., LTD.

Address: Room 203, A-1 Bldg. Zhongguancun Dongsheng Technology Park (Northern Territory), No. 66, Xixiaokou Rd, Haidian Dist., Beijing, China.

Email: support-navimow@rlm.segway.com

Authorized Representative

Name: AR Experts B.V.

Address: P.O. Box 5047, 3620 AA Breukelen, The Netherlands

Email: info@certification-experts.com

Object of the declaration

Generic designation: Robot lawn mower

Product name: Segway Navimow X3 Series

Type/model: X315E/X330E/X350E/X390E

Serial number: 0EBB x yyyy x yyyy/0ECB x yyyy x yyyy/0EDB x yyyy x yyyy/0ELB x yyyy x yyyy ("x" indicates any letter from A-Z except O and I, "y" indicates any letter from A-Z except O and I or any number from 0-9)

This Declaration of Conformity is issued under the sole responsibility of the manufacturer.

The object of the declaration described above is in conformity with the following EU Directives:

1. Radio Equipment Directive (2014/53/EU)
2. Machinery Directive (2006/42/EC)
3. RoHS Directive (2011/65/EU) and amending directive ((EU)2015/863)

Conformity with these Directives has been assessed for this product by demonstrating compliance to the following harmonized standards and/ or technical specifications:

43

EN 60335-1:2012 +A11:2014 +A13:2017 +A1:2019 +A14:2019 +A2:2019 +A15:2021

EN 50636-2-107:2015+A1:2018+A2:2020+A3:2021

EN IEC 55014-1:2021

EN 301 908-1 V15.2.1

EN IEC 55014-2:2021

EN 301 489-1 V2.2.3

EN 300 220-1 V3.1.1

EN 301 489-3 V2.3.2

EN 300 220-2 V3.1.1

EN 301 489-17 V3.3.1

EN 300 328 V2.2.2

EN 301 489-19 V2.2.1

EN 303 413 V1.2.1

EN 301 489-52 V1.2.1

EN 50665:2017

EN 301 908-13 V13.2.1

EN 62133-2:2017

EN IEC 62311:2020

EN IEC 63000:2018

EN 300440 V2.1.1

EN 301893 V2.1.1

Signed for and on behalf of: Navimow B.V.

Place: Changzhou, China

Date: 2024-12-30

Name: Crystal Zhuang

Function: Certification Manager

Signature: *Crystal Zhuang*

EC Declaration of Conformity for Antenna

Manufacturer: Willand (Beijing) Technology Co., LTD.

Address: Room 203, A-1 Bldg. Zhongguancun Dongsheng Technology Park (Northern Territory), No. 66, Xixiaokou Rd, Haidian Dist., Beijing, China.

Email: support-navimow@rlm.segway.com

Authorized Representative

Name: AR Experts B.V.

Address: P.O. Box 5047, 3620 AA Breukelen, The Netherlands

Email: info@certification-experts.com

Object of the declaration

Generic designation: Antenna (Primary)

Product name: Antenna (Primary)

Type/model: X3R00G

Serial number: PXBA x yyyy x yyyy/PXBC x yyyy x yyyy/PXBD x yyyy x yyyy ("x" indicates any letter from A-Z except 0 and I, "y" indicates any letter from A-Z except O and I or any number from 0-9)

This Declaration of Conformity is issued under the sole responsibility of the manufacturer.

The object of the declaration described above is in conformity with the following EU Directives:

1. Radio Equipment Directive (2014/53/EU)
2. RoHS Directive (2011/65/EU) and amending directive ((EU)2015/863)

Conformity with these Directives has been assessed for this product by demonstrating compliance to the following harmonized standards and/ or technical specifications:

| | |
|---------------------|----------------------|
| EN 300 220-1 V3.1.1 | EN 300440 V2.1.1 |
| EN 300 220-2 V3.1.1 | EN 301 489-1 V2.2.3 |
| EN IEC 63000:2018 | EN 301 489-3 V2.3.2 |
| EN 303 413 V1.2.1 | EN 301 489-19 V2.2.1 |
| EN 50665:2017 | EN IEC 62311:2020 |

44

Signed for and on behalf of: Navimow B.V.

Place: Changzhou, China

Date: 2024-12-30

Name: Crystal Zhuang

Function: Certification Manager

Signature: *Crystal Zhuang*

EC Declaration of Conformity for Charging Station

Manufacturer: Willand (Beijing) Technology Co., LTD.

Address: Room 203, A-1 Bldg. Zhongguancun Dongsheng Technology Park (Northern Territory), No. 66, Xixiaokou Rd, Haidian Dist., Beijing, China.

Email: support-navimow@rlm.segway.com

Authorized Representative

Name: AR Experts B.V.

Address: P.O. Box 5047, 3620 AA Breukelen, The Netherlands

Email: info@certification-experts.com

Object of the declaration

Generic designation: Navimow Charging Station

Product name: Navimow Charging Station

Type/model: X3C00G

Serial number: 0EBB x yyyy x yyyy/0ECB x yyyy x yyyy/0EDB x yyyy x yyyy/0ELB x yyyy x yyyy ("x" indicates any letter from A-Z except O and I, "y" indicates any letter from A-Z except O and I or any number from 0-9)

This Declaration of Conformity is issued under the sole responsibility of the manufacturer.

The object of the declaration described above is in conformity with the following EU Directives:

1. Electromagnetic Compatibility Directive (2014/30/EU)
2. RoHS Directive (2011/65/EU) and amending directive ((EU)2015/863)

Conformity with these Directives has been assessed for this product by demonstrating compliance to the following harmonized standards and/ or technical specifications:

EN IEC 61000-6-3:2021
EN IEC 61000-6-1:2019
EN IEC 63000:2018

45

Signed for and on behalf of: Navimow B.V.

Place: Changzhou, China

Date: 2024-12-30

Name: Crystal Zhuang

Function: Certification Manager

Signature: *Crystal Zhuang*

6.1.2 Limited Warranty

Limited Warranty and Arbitration Agreement

NOTICE: PLEASE READ THIS LIMITED WARRANTY AND ARBITRATION AGREEMENT AND KEEP THIS AGREEMENT FOR FUTURE REFERENCE. THIS AGREEMENT CONTAINS LIMITED WARRANTY CLAUSES FOR CONSUMERS IN EUROPE AND ARBITRATION CLAUSES WITH RESPECT TO NAVIMOW ("PRODUCT") AND ANY AND ALL TRANSACTION AND CLAIM RELATED TO AND/OR ARISING OUT OF THE PRODUCT.

THIS IS A BINDING LEGAL AGREEMENT ("AGREEMENT") BETWEEN YOU (EITHER AN INDIVIDUAL OR ENTITY) AND THE MANUFACTURER ("WILLAND"), NAVIMOW B.V. ("NAVIMOW"), AND THEIR AFFILIATES (INCLUDING BUT NOT LIMITED TO THEIR PARENT COMPANY, SUBSIDIARY, AFFILIATED COMPANIES, PREDECESSOR, SUBSEQUENT COMPANY, ADMINISTRATORS, SUCCESSORS, ASSIGNS, OFFICERS, DIRECTORS, MANAGERS, EMPLOYEES, MEMBERS, SHAREHOLDERS, AND AGENTS, ATTORNEYS, INSURERS OR REINSURERS) (COLLECTIVELY "NAVIMOW PARTIES"), NAVIMOW DEALERS (AS DEFINED BELOW) AND THEIR AFFILIATES (COLLECTIVELY "NAVIMOW DEALERS").

PURCHASING THE PRODUCT, OPENING THE PRODUCT PACKAGING, USING THE PRODUCT, RETAINING THE PRODUCT, EXPLOITING THE BENEFITS OF THIS AGREEMENT, OR ELECTRONIC ACCEPTANCE OF THIS AGREEMENT SHALL CONSTITUTE ACCEPTANCE OF THIS AGREEMENT. IN AN EVENT YOU, AS A PARENT(S) OR LEGAL GUARDIAN(S), PURCHASE THIS PRODUCT ON BEHALF OF OR FOR YOUR CHILDREN, YOU HEREBY CONSENT TO AND APPROVE IN ALL RESPECTS THE TERMS AND CONDITIONS OF THE AGREEMENT AND AGREE THAT BOTH YOU AND YOUR CHILDREN SHALL BE BOUND BY THIS AGREEMENT. YOU ACKNOWLEDGE AND AGREE THAT YOU RECEIVE SUFFICIENT NOTICE OF THIS AGREEMENT AND YOU AGREE TO THIS AGREEMENT.

Record your Product's Serial Number
Record your Product's Serial Number below. You can find the Serial Number on the exterior of the shipping box, or on the bottom of the Product.

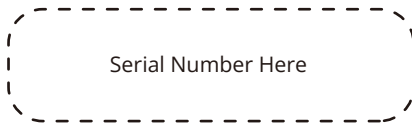

Contacts
The Product is manufactured for
Navimow B.V.
("Navimow").

1. Limited Warranty

This Limited Warranty covers only defects of any material or quality of the Product and components when the Product and components thereof are being used under normal and ordinary conditions. In the event that a defect covered by this Limited Warranty occurs, Navimow and/or other Navimow Parties in its sole discretion will repair or replace the defective Product or components thereof in accordance with this Limited Warranty, or the date it was activated (the later date prevails) from either of Navimow, Navimow's authorized reseller, Navimow's authorized distributor, or an authorized Dealer (each a "Navimow Dealer" or collectively the "Navimow Dealers").

| Product covered by this warranty | Limited Warranty Period |
|----------------------------------|-------------------------|
| X315E, X330E, X350E, X390E | 3 years |
| Battery packs and power adapters | 2 years |

Blades are seen as disposable and are not covered by this warranty.

THIS LIMITED WARRANTY HEREIN IS THE ONLY EXPRESS WARRANTY APPLICABLE TO PRODUCT AND ITS COMPONENT PARTS, ACCESSORIES, AND SERVICE REPAIR. NAVIMOW AND NAVIMOW PARTIES DISCLAIM ALL OTHER EXPRESS WARRANTIES. NAVIMOW AND OTHER NAVIMOW PARTIES LIMIT THE DURATION AND REMEDIES OF ALL IMPLIED WARRANTIES, INCLUDING WITHOUT LIMITATION TO THE WARRANTIES OF MERCHANTABILITY AND FITNESS FOR A PARTICULAR PURPOSE, WHETHER ARISING BY LAW, COURSE OF DEALING, COURSE OF PERFORMANCE, USAGE OF TRADE OR OTHERWISE, TO THE DURATION OF THIS EXPRESS LIMITED WARRANTY. THIS LIMITED WARRANTY DESCRIBES THE SERVICE AVAILABLE TO YOU IN THE EVENT YOUR PRODUCT REQUIRES WARRANTY SERVICE. THIS LIMITED WARRANTY IS AN ADDITIONAL WARRANTY, THAT DOES NOT IN ANY WAY AFFECT OR LIMIT THE STATUTORY RIGHTS YOU MAY HAVE AS A CONSUMER, FOR EXAMPLE, WITH RESPECT TO CONFORMITY, AND YOU MAY HAVE ADDITIONAL PROTECTIONS UNDER YOUR LOCAL LAWS.

2. Limited Warranty Service Process

Navimow's online services are available at navimow.segway.com. During your use of the Product, if you believe the Product or its component is defective and/or does not work correctly. PLEASE IMMEDIATELY STOP USING THE PRODUCT, AND STORE THE PRODUCT PROPERLY. YOUR CONTINUED USE OF THE PRODUCT UNDER SUCH CIRCUMSTANCE MAY CAUSE SEVERE BODILY INJURY OR EVEN DEATH TO YOU OR THE OTHERS AND/OR CAUSE PROPERTY DAMAGES. Thereafter, please immediately contact Navimow at support-navimow@rlm.segway.com. or from Live Chat via the app Navimow's technical support personnel are available to assist you online in diagnosing the defect, and if any, and providing further instructions. In the event the warranty services are required, please prepare for the following materials, including (i) proof of the original purchase of the Product, (ii) the Product's serial number, and (iii) a description of the defect if applicable. Upon the verification of your eligibility for the Limited Warranty protection and/or services, you should provide your name, email address, mailing address, and contact phone number to us, we will guide you to get our service. If you want to return the defective unit to service, you shall be responsible for the cost of shipping and risk of loss and damage that may occur during the shipment from you to Navimow and from Navimow to you. You must include your defective Product or component within the original or Navimow-approved packaging, which will be provided at your cost, for shipment of the Product to Navimow. You shall defend, indemnify, and hold Navimow harmless any loss and/or damages that may be caused by your improper packaging or shipment of the Product or component to Navimow.

An authorized service provider or Navimow Dealer will inspect your returned Product. If Navimow reasonably determines that the problem is not covered by the Limited Warranty, Navimow will notify you and inform you of service or replacement alternatives that are available to you on a fee basis, or Navimow will return your Product to you unrepairs, and in such instance, you will be responsible for the cost of shipping and insurance for shipment of your Product from Navimow to you. In an event that any service is not covered by the limited warranty and you reject a paid service recommended by Navimow Parties and/or Navimow Dealer, you understand and acknowledge that failure to repair and/or services the Product may increase the risk of fall and/or Product failure which may result in severe property damages, severe bodily injury or death, and you agree that this is your informed consent to take such risk. For a return eligible for the warranty protection and/or services, Navimow will serve defective Products with new or reconditioned parts of the same or similar style at no cost to you for the service. Parts replaced by Navimow will be retained by and become the property of Navimow. In such a situation, Navimow will pay reasonable return shipping charges for the return of the Product to you.

3. Limited Warranty Eligibility

3.1 Your service request must be received by Navimow within the Limited Warranty Period as described above, and Navimow must receive your Product in accordance with the Limited Warranty Service Process defined above.

3.2 Your Product must be purchased from an authorized Navimow Dealer.

3.3 You must provide the original purchase receipt.

3.4 Your Product must have serial number legible, unobscured, untampered, and unmodified.

3.5 All tamper-resistant seals must be intact, in place, and unmodified.

4. Limited Warranty Exclusions

This Limited Warranty describes the service available to you if your product requires warranty service, and you may have additional protections under your local laws. This Limited Warranty does not cover and excludes damage to your product or any component thereof caused by:

4.1 Abuse, misuse, recklessness, negligence, or commercial use.

4.2 Improper charging, storage, maintenance, or operation of the Product not in compliance with instructions or limitations as provided in the user materials.

4.3 Use of the Product not in compliance with applicable laws and regulations.

4.4 Use of the Product by persons with inadequate experience.

4.5 Accident, collision, fire damage, water damage, chemical damage, use of the product outside of the product's working temperature range, high-pressure water spray, earthquake, dropping.

4.6 Modifications to mechanical parts, modification of electronic parts, or modifications to software embedded in the Product. 4.7 Service, repair, and maintenance by unauthorized providers.

4.8 Cosmetic damages.

4.9 Use of the Product with third-party product, component, or accessory.

4.10 The normal deterioration of wear and tear parts.

4.11 Use of the Product with overdue wear and tear parts.

5. LIABILITY DISCLAIMER AND LIMITATION

5.1 NAVIMOW PARTIES DO NOT ASSUME OR AUTHORIZE ANYONE TO ASSUME ON ITS BEHALF, ANY OTHER OBLIGATION OR LIABILITY IN CONNECTION WITH THE PRODUCT, ITS COMPONENT PARTS, ACCESSORIES, SERVICE REPAIR, OR THIS LIMITED WARRANTY.

5.2 NAVIMOW PARTIES AND NAVIMOW DEALERS ARE NOT RESPONSIBLE FOR ANY LOSS OF USE OF A PRODUCT, ITS COMPONENT PARTS, ACCESSORIES, OR FOR ANY INCONVENIENCE OR OTHER LOSS OR DAMAGE WHICH MIGHT BE CAUSED FROM ANY DEFECT IN A PRODUCT, ITS COMPONENT PARTS, ACCESSORIES, SERVICE REPAIR, OR FOR ANY OTHER INCIDENTAL OR CONSEQUENTIAL DAMAGES YOU MAY HAVE AS A RESULT OF ANY DEFECT IN A PRODUCT, ITS COMPONENT PARTS, ACCESSORIES, OR SERVICE REPAIR. SOME COUNTRIES DO NOT ALLOW THE EXCLUSION OR LIMITATION OF INCIDENTAL OR CONSEQUENTIAL DAMAGES, SO THE ABOVE LIMITATION OR EXCLUSION MAY NOT APPLY TO YOU TO THE EXTENT THAT IT IS DISALLOWED BY APPLICABLE LAW.

5.3 IN NO EVENT, NAVIMOW PARTIES AND NAVIMOW DEALERS' TOTAL AND AGGREGATE LIABILITY FOR ALL CLAIMS UNDER ANY AND ALL APPLICABLE LAW OR THEORY, JOINTLY OR SEVERALLY, ARISING OUT OF OR RELATED TO THE PURCHASE OF THE PRODUCT, USE OF THE PRODUCT, BREACH OF CONTRACT, TORTS (INCLUDING NEGLIGENCE) OR OTHERWISE, EXCEEDS THE DUTY TO REPAIR OR REPLACE ANY DEFECTIVE PRODUCT, FURTHER SUBJECT TO NAVIMOW'S SOLE AND EXCLUSIVE DISCRETION. IN NO EVENT SHALL NAVIMOW PARTIES AND NAVIMOW DEALERS BE LIABLE TO ANY PERSON FOR CONSEQUENTIAL, INDIRECT, INCIDENTAL, SPECIAL, EXEMPLARY, PUNITIVE OR ENHANCED DAMAGES ARISING OUT OF, OR RELATING TO, AND/OR IN CONNECTION WITH THE PURCHASE OF THE PRODUCT, ANY BREACH OF THIS AGREEMENT OR MANUFACTURER'S DUTIES REGARDLESS OF (A) WHETHER SUCH DAMAGES WERE FORESEEABLE, (B) WHETHER OR NOT NAVIMOW OR OTHER NAVIMOW PARTIES WERE ADVISED OF THE POSSIBILITY OF SUCH DAMAGES, AND (C) THE LEGAL OR EQUITABLE THEORY (CONTRACT, TORT OR OTHERWISE) UPON WHICH THE CLAIM IS BASED UNLESS SUCH LIMITATIONS AND EXCLUSIONS ARE PROHIBITED BY APPLICABLE LAW. THE FOREGOING LIMITATIONS OR EXCLUSIONS APPLY EVEN IF AN AGGRIEVED CUSTOMER OR ANY OTHER PERSON'S (WHO MIGHT HAVE RIGHT OR CLAIM UNDER THIS AGREEMENT BY OPERATION OF LAW OR EQUITY) REMEDIES UNDER THIS AGREEMENT FAIL THEIR ESSENTIAL PURPOSE. IN THE EVENT SOME COUNTRIES DO NOT ALLOW THE EXCLUSION OR LIMITATION OF CERTAIN OR ALL OF THE FOREGOING DAMAGES, SO TO THE EXTENT THAT SUCH LIMITATIONS OR EXCLUSIONS ARE NOT ALLOWED BY LAW, THEY MAY NOT APPLY TO YOU. SOME COUNTRIES DO NOT ALLOW THE EXCLUSION OR LIMITATION OF INCIDENTAL OR CONSEQUENTIAL DAMAGES, SO TO THE EXTENT THAT SUCH LIMITATIONS OR EXCLUSIONS ARE NOT ALLOWED BY LAW, THE ABOVE LIMITATION OR EXCLUSION MAY NOT APPLY TO YOU.

5.4 To the extent permitted by applicable law, NAVIMOW PARTIES and NAVIMOW DEALERS hereby DISCLAIM any liability and thereby shall not be responsible for any damages, including but not limited to death, bodily injury, or damages to property, arising out of or related to any conduct (including misconduct), action, inaction, act (including failure to act), omission or negligence by any authorized or unauthorized dealer, distributor, wholesaler, retailer, service provider or third party that involves into the distribution of Product or the

services thereto. To the extent permitted by applicable law, the explicit representations and warranties, if any, provided herein, shall be the only warranties and representations made by NAVIMOW PARTIES to YOU, any consumer, and/or end-user. and NAVIMOW PARTIES shall not be responsible for any other warranties and/or representations that may be given and/or provided by another person unless NAVIMOW PARTIES have in a written form explicitly authorized such additional warranty and/or representation to be given to consumer or end-user.

6. Claims, Dispute Resolution and Arbitration

THE CLAUSES CONTAINED HEREIN ARE LEGALLY BINDING BETWEEN YOU (EITHER AN INDIVIDUAL OR ENTITY), AND NAVIMOW B.V., ITS AFFILIATES, NAVIMOW PARTIES AND NAVIMOW DEALERS. THE CLAUSES CONTAINED HEREIN MAY AFFECT YOUR RIGHTS, AND IT IS YOUR RESPONSIBILITY TO READ THE FOLLOWING SECTIONS. YOU CAN OPT OUT OF THE AGREEMENT WITHIN 30 CALENDAR DAYS OF THE FIRST CONSUMER PURCHASE BY EMAILING OPTOUT@SEGWAY.COM AND PROVIDING THE APPLICABLE INFORMATION. FOR MORE DETAILS, PLEASE SEE SECTION 6.2.

6.1 Binding Arbitration EN Navimow Parties, Navimow Dealers and you agree that any dispute, controversy or claim arising out of, relating to or in connection with this agreement, the limited warranty, the sale, condition or performance of the product, whether based in contract, tort, fraud, misrepresentation, or any other legal theory at law or in equity, including but not limited to any claims for death, injury or property damages, shall be governed by and construed in accordance with the laws of the Netherlands with the exclusion of its conflicts of law provisions.

Any disputes arising from, out of, or in connection with this Agreement shall be settled through friendly consultations between the Parties. In case no resolution can be reached through consultations, the dispute shall be submitted to the Arbitration Institute of the Netherlands (NAI) for arbitration which shall be conducted in accordance with its rules of in effect at the time of applying for arbitration. Both Parties further acknowledge and confirm that the arbitral award shall be final and binding upon all Parties, not subject to any appeal, and shall deal with the question of costs of arbitration and all matters related thereto. The enforcement of the arbitral award shall be conducted by a court of competent jurisdiction.

Further the Parties agree that:

- i. The seat of the arbitration shall be Amsterdam, Netherlands.
- ii. The Tribunal shall consist of 3 arbitrator(s).
- iii. The language of the arbitration shall be English.

Section 6 "Claims, Dispute Resolution and Arbitration" clause shall survive upon termination or expiration of this agreement and/or limited warranty or in an event that this agreement and/or the limited warranty is held as void, avoidable, invalid, or unenforceable, either in whole or part, by a competent adjudication institution with actual authority and jurisdiction over this matter.

6.2 Opt-Out

YOU MAY OPT OUT OF THIS DISPUTE RESOLUTION PROCEDURE BY PROVIDING NOTICE TO NAVIMOW or NAVIMOW PARTIES NO LATER THAN THIRTY (30) CALENDAR DAYS AFTER THE DATE OF THE FIRST CONSUMER PURCHASER'S PURCHASE OF THE PRODUCT. TO OPT-OUT, YOU MUST SEND NOTICE BY EMAIL AT OPTOUT@SEGWAY.COM, WITH THE SUBJECT LINE: "ARBITRATION OPT-OUT." THE OPT-OUT NOTICE BY E-MAIL MUST INCLUDE (A) YOUR NAME, EMAIL ADDRESS, MAILING ADDRESS, AND PHONE NUMBER; (B) THE DATE ON WHICH THE PRODUCT WAS PURCHASED; (C) THE PRODUCT MODEL NAME OR MODEL NUMBER; AND (D) THE SERIAL NUMBER. ALTERNATIVELY, YOU MAY OPT OUT BY SENDING AN ELECTION TO OPT-OUT LETTER TO NAVIMOW AT Dynamostraat 7, 1014BN, Amsterdam, The Netherlands. CERTIFIED MAIL WITHIN THIRTY (30) CALENDAR DAYS FROM THE DATE OF THE FIRST END USER'S PURCHASE OF THE PRODUCT FROM NAVIMOW DEALER. THE OPT-OUT LETTER SHALL CONTAIN THE FOLLOWING INFORMATION: (A) YOUR NAME, EMAIL ADDRESS, MAILING ADDRESS, AND PHONE NUMBER; (B) THE DATE ON WHICH THE PRODUCT WAS PURCHASED; (C) THE PRODUCT MODEL NAME OR MODEL NUMBER; (D) THE SERIAL NUMBER; AND (E) AN STATEMENT AS FOLLOWS: THE ABOVE CONSUMER ELECTS TO OPT-OUT OF THE DISPUTE RESOLUTION PROCEDURE AS PROVIDED BY THIS LIMITED WARRANTY, THESE ARE THE ONLY TWO EFFECTIVE WAYS TO OPT-OUT OF THIS DISPUTE RESOLUTION PROCEDURE. ELECTION TO OPT-OUT THIS DISPUTE RESOLUTION PROCEDURE WILL NOT AFFECT THE COVERAGE OF THE LIMITED WARRANTY IN ANY WAY, AND YOU WILL CONTINUE TO ENJOY THE BENEFITS OF THE LIMITED WARRANTY.

6.3 Language

This Agreement may be translated into different languages. In the event of a conflict, the English version shall prevail and control.

7. Intended third Party Beneficiary

(a) If a natural person receives a Product that is new as a gift from its original purchaser and this recipient does not become a party to this Agreement, this recipient shall be deemed as an intended third-party beneficiary to this Agreement. (b) If (i) a natural person is in the family or household of a purchaser of Product, (ii) it is reasonable to expect that such person may use, consume, or be affected by the Product, and (iii) this person is not a party to this Agreement, this person shall be deemed as an intended third-party beneficiary to this Agreement.

8. Statute of Limitation

The parties agree that any dispute, controversy, or claim arising out of, related to, or in connection with this Agreement, the limited warranty, the sale, condition, or performance of the Product, whether based in contract, tort, fraud, misrepresentation or any other legal theory at law or in equity, including but not limited to any claims for death, injury or property damages, must be commenced within one year after the cause of action has occurred.

9. Severability

If any term, clause, or provision of this Agreement is invalid, illegal or unenforceable in any jurisdiction, such invalidity, illegality, or unenforceability shall not affect any other term, clause or provision of this Agreement or invalidate or render unenforceable such term, clause or provision in any other jurisdiction. Upon a determination that any term, clause, or provision is invalid, illegal, or unenforceable, the parties shall negotiate in good faith, and if negotiation fails, the arbitral tribunal may modify this Agreement to give effect to the original intent of the parties as closely as possible in order that the transactions contemplated hereby be consummated as originally contemplated to the greatest extent possible.

6.1.3 Certifications

European Union Compliance Statement

Information on Disposal for Users of Waste Electrical & Electronic Equipment



This symbol on the product or on its packaging indicates that used electrical and electronic products should not be mixed with unsorted municipal waste. For proper treatment, it is your responsibility to dispose of your waste equipment by arranging to return it to designated collection points.

Disposing of this product correctly will help save valuable resources and prevent any potential negative effects on human health and the environment, which could otherwise arise from inappropriate waste handling.

To return your used device, please use the return and collection systems or contact the retailer where the product was purchased, which is free of charge, please contact your local authority for further details of your nearest designated collection point.

Penalties may be applicable for incorrect disposal of this waste, in accordance with your national legislation.

Information on Disposal for Users of used batteries



This symbol means that batteries and accumulators, at their end-of-life, should not be mixed with unsorted municipal waste. Your participation is an important part of the effort to minimize the impact of batteries and accumulators on the environment and on human health. For proper recycling you can return this product or the batteries or accumulators it contains to your supplier or to a designated collection point, which is free of charge.

Disposing of this product correctly will help save valuable resources and prevent any potential negative effects on human health and the environment, which could otherwise arise from inappropriate waste handling.

Penalties may be applicable for incorrect disposal of this waste, in accordance with your national legislation. there are separate collection systems for used batteries and accumulators.

Please, dispose of batteries and accumulators correctly at your local community waste collection/recycling center.

Restriction of the use of certain hazardous substances (RoHS) Directive

Navimow B.V. hereby declares the whole product including parts (cables, cords, and so on) meets the requirements of RoHS Directive 2011/65/EU and amendment Commission Delegated Directive (EU) 2015/863 on the restriction of the use of certain hazardous substances in electrical and electronic equipment ("RoHS recast" or "RoHS 2.0").

Radio Equipment Directive

Navimow B.V. hereby declares that the product listed in this section comply with the essential requirements and other relevant provisions of the Radio Equipment Directive 2014/53/EU.

Machinery Directive

Navimow B.V. hereby declares that the product listed in this section comply with the essential requirements and other relevant provisions of the Machinery Directive 2006/42/EC.

Europe Authorised Representative:



AR Experts B.V., P.O. Box 5047, 3620 AA Breukelen, The Netherlands

Navimow B.V. hereby declares that the product comply with the essential requirements and other relevant provisions of the RoHS Directive 2011/65/EU and amendment Commission Delegated Directive (EU) 2015/863, the Radio Equipment Directive 2014/53/EU and the Machinery Directive 2006/42/EC.

| | | |
|-------------|-------------------|---------------------------|
| Bluetooth | Frequency Band(s) | 2.402-2.480GHz |
| | Max. RF Power | 20mW |
| SRD | Frequency Band(s) | 865.05-867.9MHz |
| | Max. RF Power | 13.85dBm (ERP) |
| 2.4G WLAN | Frequency Band(s) | 2412-2472MHz |
| | Max. RF Power | 19.87dBm (EIRP) |
| 5.6G WLAN | Frequency Band(s) | 5180-5240MHz |
| | Max. RF Power | 17dBm (EIRP) |
| 5.8G WLAN | Frequency Band(s) | 5260-5320MHz |
| | Max. RF Power | 12dBm (EIRP) |
| LTE Band 1 | Frequency Band(s) | 5500-5700MHz |
| | Max. RF Power | 7dBm (EIRP) |
| LTE Band 3 | Frequency Band(s) | 5745-5825MHz |
| | Max. RF Power | 11dBm (EIRP) |
| LTE Band 5 | Frequency Band(s) | 880-915MHz/925-960MHz |
| | Max. RF Power | 35dBm (Conducted Rated) |
| LTE Band 7 | Frequency Band(s) | 1710-1785MHz/1805-1880MHz |
| | Max. RF Power | 32dBm (Conducted Rated) |
| LTE Band 8 | Frequency Band(s) | 1920-1980MHz/2110-2170MHz |
| | Max. RF Power | 25dBm (Conducted Rated) |
| LTE Band 20 | Frequency Band(s) | 1710-1785MHz/1805-1880MHz |
| | Max. RF Power | 25dBm (Conducted Rated) |
| LTE Band 28 | Frequency Band(s) | 2500-2570MHz/2620-2690MHz |
| | Max. RF Power | 25dBm (Conducted Rated) |
| LTE Band 38 | Frequency Band(s) | 880-915MHz/925-960MHz |
| | Max. RF Power | 25dBm (Conducted Rated) |
| LTE Band 40 | Frequency Band(s) | 832-862MHz/791-821MHz |
| | Max. RF Power | 25dBm (Conducted Rated) |

| GNSS Specification | GNSS Signal Designations | Frequency band(MHz) |
|--------------------|--------------------------|---------------------|
| GPS | L1 | 1559-1610 |
| | L2 | 1215-1300 |
| | L5 | 1164-1215 |
| Galileo | E1 | 1559-1610 |
| | E5b | 1164-1215 |
| | E5a | 1164-1215 |
| BDS | B1C | 1559-1610 |
| | B1I | 1559-1610 |
| | B2a | 1164-1215 |

6.2 North America

6.2.1 Certifications

The battery complies with UN/DOT 38.3

Federal Communications Commission (FCC) Compliance Statement for USA

This device complies with Part 15 of the FCC Rules. Operation is subject to the following two conditions: (1) This device may not cause harmful interference, and (2) this device must accept any interference received, including interference that may cause undesired operation.

Note: This equipment has been tested and found to comply with the limits for a Class B digital device, pursuant to Part 15 of the FCC Rules. These limits are designed to provide reasonable protection against harmful interference in a residential installation. This equipment generates, uses and can radiate radio frequency energy and, if not installed and used in accordance with the instructions, may cause harmful interference to radio communications. However, there is no guarantee that interference will not occur in a particular installation.

If this equipment does cause harmful interference to radio or television reception, which can be determined by turning the equipment off and on, the user is encouraged to try to correct the interference by one or more of the following measures:

- Reorient or relocate the receiving antenna.
- Increase the separation between the equipment and receiver.
- Connect the equipment into an outlet on a circuit different from that to which the receiver is connected.
- Consult the dealer or an experienced radio/TV technician for help.

This equipment complies with FCC radiation exposure limits set forth for an uncontrolled environment. This equipment should be installed and operated with minimum distance 7.87 in (20 cm) between the radiator and your body. This transmitter must not be co-located or operating in conjunction with any other antenna or transmitter.

FCC Caution: Any changes or modifications not expressly approved by the party responsible for compliance could void the user's authority to operate this equipment.

Industry Canada (IC) Compliance Statement for Canada

This device contains licence-exempt transmitter(s) that comply with Innovation, Science and Economic Development Canada's licence-exempt RSS(s).

Operation is subject to the following two conditions:

1. This device may not cause interference.
2. This device must accept any interference, including interference that may cause undesired operation of the device.

L'émetteur exempt de licence contenu dans le présent appareil est conforme aux CNR d'Innovation, Sciences et Développement économique Canada applicables aux appareils radio exempts de licence. L'exploitation est autorisée aux deux conditions suivantes :

1. L'appareil ne doit pas produire de brouillage;
2. L'appareil doit accepter tout brouillage radioélectrique subi, même si le brouillage est susceptible d'en compromettre le fonctionnement.

This equipment complies with IC RSS-102 radiation exposure limits set forth for an uncontrolled environment. This transmitter must not be co-located or operating in conjunction with any other antenna or transmitter. This equipment should be installed and operated with minimum distance 7.87 in (20 cm) between the radiator and your body.

Cet équipement est conforme aux limites d'exposition au rayonnements IC RSS-102 établies pour un environnement non contrôlé. Cet équipement doit être installé et utilisé avec un minimum de 20cm de distance entre la source de rayonnement et votre corps.

Navimow is not responsible for any changes or modifications not expressly approved by Navimow. Such modifications could void the user's authority to operate the equipment.

Model: X315N/X330N/X350N/X390N
FCC ID: 2BAXN-MR0005
IC: 30433-MR0005

Model: EC25AFX
Contains FCC ID: XMR201909EC25AFX
Contains IC: 10224A-2019EC25AFX

6.2.2 Limited Warranty

Limited Warranty and Arbitration Agreement

NOTICE: PLEASE READ THIS LIMITED WARRANTY AND ARBITRATION AGREEMENT AND KEEP THIS AGREEMENT FOR FUTURE REFERENCE. THIS AGREEMENT CONTAINS LIMITED WARRANTY CLAUSES AND ARBITRATION CLAUSES WITH RESPECT TO NAVIMOW("PRODUCT") AND ANY AND ALL TRANSACTION AND CLAIM RELATED TO AND/OR ARISING OUT OF THE PRODUCT.

THIS IS A BINDING LEGAL AGREEMENT ("AGREEMENT") BETWEEN YOU (EITHER AN INDIVIDUAL OR ENTITY) AND THE MANUFACTURER WILLAND (BEIJING) TECHNOLOGY CO., LTD ("WILLAND") AND ITS AFFILIATES (INCLUDING BUT NOT LIMITED TO THEIR PARENT COMPANY, SUBSIDIARY, AFFILIATED COMPANIES, PREDECESSOR, SUBSEQUENT COMPANY, ADMINISTRATORS, SUCCESSORS, ASSIGNS, OFFICERS, DIRECTORS, MANAGERS, EMPLOYEES, MEMBERS, AND SHAREHOLDERS) (COLLECTIVELY "NAVIMOW PARTIES"), NAVIMOW DEALERS (AS DEFINED BELOW) AND THEIR AFFILIATES (COLLECTIVELY "NAVIMOW DEALERS").

PURCHASING THE PRODUCT, OPENING THE PRODUCT PACKAGING, USING THE PRODUCT, RETAINING THE PRODUCT, EXPLOITING THE BENEFITS OF THIS AGREEMENT, OR ELECTRONIC ACCEPTANCE OF THIS AGREEMENT SHALL CONSTITUTE ACCEPTANCE OF THIS AGREEMENT. IN AN EVENT YOU, AS A PARENT(S) OR LEGAL GUARDIAN(S), PURCHASE THIS PRODUCT ON BEHALF OF OR FOR YOUR CHILDREN, YOU HEREBY CONSENT TO AND APPROVE IN ALL RESPECTS THE TERMS AND CONDITIONS OF THE AGREEMENT AND AGREE THAT BOTH YOU AND YOUR CHILDREN SHALL BE BOUND BY THIS AGREEMENT. YOU ACKNOWLEDGE AND AGREE THAT YOU RECEIVE SUFFICIENT NOTICE OF THIS AGREEMENT AND YOU AGREE TO THIS AGREEMENT.

THE AGREEMENT ONLY AND EXCLUSIVELY APPLIES TO THE PRODUCT DISTRIBUTED AND/OR SOLD BY AND/OR THROUGH NAVIMOW PARTIES OR NAVIMOW DEALERS IN THE NORTH AMERICAN MARKET. IF YOU ARE NOT A RESIDENT IN THE NORTH AMERICAN MARKET, PLEASE CONTACT US BEFORE USING THE PRODUCT AS YOU MAY NOT HAVE A WARRANTY OR HAVE A DIFFERENT WARRANTY THAN THE ONE PROVIDED HEREIN.

THE LIMITED WARRANTY CAN ALSO BE FOUND ONLINE AT: navimow.segway.com

WARNING

USE OF THE PRODUCT BY A PERSON WHO HAS NOT RECEIVED SUFFICIENT TRAINING, DOES NOT POSSESS NECESSARY EXPERIENCE AND SKILLS, OR AGAINST, IN VIOLATION OF OR NOT ACCORDING TO THE USER MANUAL, INSTRUCTIONS, GUIDANCE AND/OR SAFETY WARNINGS MAY CAUSE SEVERE BODILY INJURY OR EVEN DEATH OR PROPERTY DAMAGES.

PLEASE READ EACH AND EVERY SECTION OF THIS DOCUMENT CAREFULLY BEFORE USE OF THE PRODUCT. YOU ARE ENCOURAGED TO CONSULT WITH YOUR PROFESSIONALS AND ADVISORS REGARDING THE INFORMATION PROVIDED HEREIN, ESPECIALLY THOSE RELATED TO THE SAFETY AND YOUR LEGAL RIGHTS AND DUTIES.

1. Limited Warranty

This Limited Warranty covers only defects of any material or quality of the Product and components when the Product and components thereof are being used under normal and ordinary conditions. In the event that a defect covered by this Limited Warranty occurs, Navimow and/or other Navimow Parties in its sole discretion will repair or replace the defective Product or components thereof in accordance with this Limited Warranty. The applicable Limited Warranty Period for the Limited Warranty commences on the date of the original purchase of the Product from either of Navimow, Navimow's authorized reseller, Navimow's authorized distributor, or an authorized Dealer (each a "Navimow Dealer" or collectively the "Navimow Dealers"). This warranty gives you specific legal rights, and if you are a consumer in the United States of America, you may also have other rights which vary from State to State.

| Product covered by this warranty | Limited Warranty Period |
|----------------------------------|-------------------------|
| X315N, X330N, X350N, X390N | 3 years |
| Battery packs and power adapters | 2 years |

Blades are seen as disposable and are not covered by this warranty.

The later date from the following is considered as the start time of the Limited Warranty Period:

- Date of the purchase time
- Date of first-time activation

THIS LIMITED WARRANTY HEREIN IS THE ONLY EXPRESS WARRANTY APPLICABLE TO PRODUCT AND ITS COMPONENT PARTS, ACCESSORIES, AND SERVICE REPAIR. NAVIMOW AND NAVIMOW PARTIES DISCLAIM ALL OTHER EXPRESS WARRANTIES. NAVIMOW AND OTHER NAVIMOW PARTIES LIMIT THE DURATION AND REMEDIES OF ALL IMPLIED WARRANTIES, INCLUDING WITHOUT LIMITATION TO THE WARRANTIES OF MERCHANTABILITY AND FITNESS FOR A PARTICULAR PURPOSE, WHETHER ARISING BY LAW, COURSE OF DEALING, COURSE OF PERFORMANCE, USAGE OF TRADE OR OTHERWISE, TO THE DURATION OF THIS EXPRESS LIMITED WARRANTY. THE FOREGOING LIMITATIONS OR EXCLUSIONS OF WARRANTY SHALL SUBJECT TO ANY MANDATORY LAW THAT PROHIBITS SUCH EXCLUSION, LIMITATION, RESTRICTION, OR MODIFICATION OF WARRANTY. FOR ANY WARRANTY THAT MAY APPLY HEREIN ON THE GROUND THAT SUCH WARRANTY IS MANDATED BY LAW AND CANNOT BE EFFECTIVELY EXCLUDED, RESTRICTED OR MODIFIED BY THE FOREGOING DISCLAIMER, THE DURATION OF ITS APPLICABILITY SHALL BE THE PERIOD PROVIDED BY THE LIMITED WARRANTY HEREIN OR THAT REQUIRED BY THE APPLICABLE COUNTRY/STATE LAW, WHICHEVER IS

SHORTER. SOME COUNTRIES/STATES DO NOT ALLOW LIMITATIONS ON HOW LONG AN IMPLIED WARRANTY LASTS, SO THE ABOVE LIMITATION MAY NOT APPLY TO YOU.

2. Limited Warranty Service Process

Navimow's online services are available at navimow.segway.com. During your use of the Product, you believe the Product or its component is defective and/or does not work correctly. PLEASE IMMEDIATELY STOP USING THE PRODUCT, AND STORE THE PRODUCT PROPERLY. YOUR CONTINUED USE OF THE PRODUCT UNDER SUCH CIRCUMSTANCE MAY CAUSE SEVERE BODILY INJURY OR EVEN DEATH TO YOU OR THE OTHERS AND/OR CAUSE PROPERTY DAMAGES. Thereafter, please immediately contact Navimow at support-navimow@rlm.segway.com. Navimow's technical support personnel are available to assist you online or over the phone in diagnosing the defect, and if any, and providing further instructions. In the event the warranty services are required, please prepare for the following materials, including (i) proof of the original purchase of the Product from Navimow Dealers, (ii) the Product's serial number, and (iii) a description of the defect if applicable. Upon the verification of your eligibility for the Limited Warranty protection and/or services, you should provide your name, email address, mailing address, and contact phone number to us, we will guide you to get our service.

If you want to return the defective unit to service, you shall be responsible for the cost of shipping and risk of loss and damage that may occur during the shipment from you to Navimow and (ii) from Navimow to you. You must include your defective Product or component within the original or Navimow-approved packaging, which will be provided at your cost, for shipment of the Product to Navimow. You shall defend, indemnify, and hold Navimow harmless any loss and/or damages that may be caused by your improper packaging or shipment of the Product or component to Navimow.

An authorized service provider or Navimow Dealer will inspect your returned Product. If Navimow reasonably determines that the problem is not covered by the Limited Warranty, Navimow will notify you and inform you of service or replacement alternatives that are available to you on a fee basis, or Navimow will return your Product to you unrepaired, and in such instance, you will be responsible for the cost of shipping and insurance for shipment of your Product from Navimow to you. In an event that any services is not covered by the limited warranty and you reject a paid service recommended by Navimow Parties and/or Navimow Dealer, you understand and acknowledge that failure to repair and/or services the Product may increase the risk of fall and/or Product failure which may result in severe property damages, severe bodily injury or death, and you agree that this is your informed consent to take such risk.

For a return eligible for the warranty protection and/or services, Navimow will serve defective Products with new or reconditioned parts of the same or similar style at no cost to you for the service. Parts replaced by Navimow will be retained by and become the property of Navimow. In such a situation, Navimow will pay reasonable return shipping charges for the return of the Product to you.

3. Limited Warranty Eligibility

- 3.1 Your service request must be received by Navimow within the Limited Warranty Period as described above, and Navimow must, receive your Product in accordance with the Limited Warranty Service Process defined above.
- 3.2 Your Product must be purchased from an authorized Navimow Dealer.
- 3.3 You must provide the original purchase receipt.
- 3.4 Your Product must have serial number legible, unobscured, untampered, and unmodified.
- 3.5 All tamper-resistant seals must be intact, in place, and unmodified.

4. Limited Warranty Exclusions

This Limited Warranty describes the service available to you if your product requires warranty service, and you may have additional protections under your local laws. This Limited Warranty does not cover and excludes damage to your product or any component thereof caused by:

- 4.1 Abuse, misuse, recklessness, negligence, or commercial use.
- 4.2 Improper charging, storage, maintenance, or operation of the Product not in compliance with instructions or limitations as provided in the user materials.
- 4.3 Use of the Product not in compliance with applicable laws and regulations.
- 4.4 Use of the Product by persons with inadequate experience.
- 4.5 Accident, collision, riding at an unsafe speed on paved roads, riding at an unsafe speed on unpaved roads, riding over obstacles, amateur racing, professional racing, use in backcountry sports, fire damage, water damage, chemical damage, use of the Product outside of the Product's working temperature range, high-pressure water spray, earthquake, dropping, loading with excessive weights.
- 4.6 Modifications to mechanical parts, modification of electronic parts, or modifications to software embedded in the Product.
- 4.7 Service, repair, and maintenance by unauthorized providers.
- 4.8 Cosmetic damages.
- 4.9 Use of the Product with third-party product, component, or accessory.
- 4.10 The normal deterioration of wear and tear parts.
- 4.11 Use of the Product with overdue wear and tear parts.

5. LIABILITY DISCLAIMER AND LIMITATION

- 5.1 NAVIMOW AND OTHER NAVIMOW PARTIES DO NOT ASSUME OR AUTHORIZE ANYONE TO ASSUME ON ITS BEHALF, ANY OTHER OBLIGATION OR LIABILITY IN CONNECTION WITH THE PRODUCT, ITS COMPONENT PARTS, ACCESSORIES, SERVICE REPAIR, OR THIS LIMITED WARRANTY.

- 5.2 NAVIMOW PARTIES AND NAVIMOW DEALERS ARE NOT RESPONSIBLE FOR ANY LOSS OF USE OF A PRODUCT, ITS COMPONENT PARTS, ACCESSORIES, OR FOR ANY INCONVENIENCE OR OTHER LOSS OR DAMAGE WHICH MIGHT BE CAUSED FROM ANY DEFECT IN A PRODUCT, ITS COMPONENT PARTS, ACCESSORIES, SERVICE REPAIR, OR FOR ANY OTHER INCIDENTAL OR CONSEQUENTIAL DAMAGES YOU MAY HAVE AS A RESULT OF ANY DEFECT IN A PRODUCT, ITS COMPONENT PARTS, ACCESSORIES, OR SERVICE REPAIR. SOME COUNTRIES/STATES DO NOT ALLOW THE EXCLUSION OR LIMITATION OF INCIDENTAL OR CONSEQUENTIAL DAMAGES, SO THE ABOVE LIMITATION OR EXCLUSION MAY NOT APPLY TO YOU TO THE EXTENT THAT IT IS DISALLOWED BY APPLICABLE LAW.
- 5.3 IN NO EVENT NAVIMOW, OTHER NAVIMOW PARTIES AND NAVIMOW DEALERS' TOTAL AND AGGREGATE LIABILITY FOR ALL CLAIMS UNDER ANY AND ALL APPLICABLE LAW OR THEORY, JOINTLY OR SEVERALLY, ARISING OUT OF OR RELATED TO THE PURCHASE OF THE PRODUCT, USE OF THE PRODUCT, BREACH OF CONTRACT, TORTS (INCLUDING NEGLIGENCE) OR OTHERWISE, EXCEEDS THE DUTY TO REPAIR OR REPLACE ANY DEFECTIVE PRODUCT, FURTHER SUBJECT TO NAVIMOW'S SOLE AND EXCLUSIVE DISCRETION. IN NO EVENT SHALL BE NAVIMOW, OTHER NAVIMOW PARTIES AND NAVIMOW DEALERS BE LIABLE TO ANY PERSON FOR CONSEQUENTIAL, INDIRECT, INCIDENTAL, SPECIAL, EXEMPLARY, PUNITIVE OR ENHANCED DAMAGES ARISING OUT OF, OR RELATING TO, AND/OR IN CONNECTION WITH THE PURCHASE OF THE PRODUCT, ANY BREACH OF THIS AGREEMENT OR MANUFACTURER'S DUTIES REGARDLESS OF (A) WHETHER SUCH DAMAGES WERE FORESEEABLE, (B) WHETHER OR NOT NAVIMOW OR OTHER NAVIMOW PARTIES WERE ADVISED OF THE POSSIBILITY OF SUCH DAMAGES, AND (C) THE LEGAL OR EQUITABLE THEORY (CONTRACT, TORT OR OTHERWISE) UPON WHICH THE CLAIM IS BASED UNLESS SUCH LIMITATIONS AND EXCLUSIONS ARE PROHIBITED BY APPLICABLE LAW. THE FOREGOING LIMITATIONS OR EXCLUSIONS APPLY EVEN IF AN AGGRIEVED CUSTOMER OR ANY OTHER PERSON'S (WHO MIGHT HAVE RIGHT OR CLAIM UNDER THIS AGREEMENT BY OPERATION OF LAW OR EQUITY) REMEDIES UNDER THIS AGREEMENT FAIL THEIR ESSENTIAL PURPOSE. IN THE EVENT SOME COUNTRIES/STATES DO NOT ALLOW THE EXCLUSION OR LIMITATION OF CERTAIN OR ALL OF THE FOREGOING DAMAGES, SO TO THE EXTENT THAT SUCH LIMITATIONS OR EXCLUSIONS ARE NOT ALLOWED BY LAW, THEY MAY NOT APPLY TO YOU. SOME COUNTRIES/STATES DO NOT ALLOW THE EXCLUSION OR LIMITATION OF INCIDENTAL OR CONSEQUENTIAL DAMAGES, SO TO THE EXTENT THAT SUCH LIMITATIONS OR EXCLUSIONS ARE NOT ALLOWED BY LAW, THE ABOVE LIMITATION OR EXCLUSION MAY NOT APPLY TO YOU.
- 5.4 To the extent permitted by applicable law, NAVIMOW PARTIES hereby DISCLAIM any liability and thereby shall not be responsible for any damages, including but not limited to death, bodily injury, or damages to property, arising out of or related to any conduct (including misconduct), action, inaction, act (including failure to act), omission or negligence by any authorized or unauthorized dealer, distributor, wholesaler, retailer, service provider or third party that involves the distribution of Product or the services thereto. To the extent permitted by applicable law, the explicit representations and warranties, if any, provided herein, shall be the only warranties and representations made by NAVIMOW PARTIES to YOU, any consumer, and/or end-user. NAVIMOW PARTIES shall not be responsible for any other warranties and/or representations that may be given and/or provided by another person unless NAVIMOW Parties have in a written form explicitly authorized such additional warranty and/or representation to be given to consumer or end-user.

6. Claims, Dispute Resolution and Arbitration

THE CLAUSES CONTAINED HEREIN ARE LEGALLY BINDING BETWEEN YOU (EITHER AN INDIVIDUAL OR ENTITY), AND NAVIMOW, ITS AFFILIATES, NAVIMOW PARTIES AND NAVIMOW DEALERS. THE CLAUSES CONTAINED HEREIN MAY AFFECT YOUR RIGHTS, AND IT IS YOUR RESPONSIBILITY TO READ THE FOLLOWING SECTIONS. YOU CAN OPT OUT OF THE AGREEMENT WITHIN 30 CALENDAR DAYS OF THE FIRST CONSUMER PURCHASE BY EMAILING OPTOUT@SEGWAY.COM AND PROVIDING THE APPLICABLE INFORMATION. FOR MORE DETAILS, PLEASE SEE SECTION 6.3.

6.1 Binding Arbitration

Navimow Parties, Navimow Dealers, and you agree that any dispute, controversy, or claim arising out of, related to or in connection with this Agreement, the limited warranty, the sale, condition, or performance of the Product, whether based in contract, tort, fraud, misrepresentation or any other legal theory at law or in equity, including but not limited to any claims for death, injury or property damages, shall be submitted to binding arbitration upon the request of either party upon the service of that request on the other party.

The arbitration shall be conducted by the American Arbitration Association (AAA) according to its Commercial Arbitration Rules and the Supplementary Procedures for Consumer-Related Disputes (collectively "AAA Rules"). The AAA Rules are available online at adr.org or by calling the AAA at 1-800-778-7879. The arbitration shall be conducted before a single arbitrator, whose award may not exceed, in form or amount, the relief allowed by the "Liability Disclaimer and Limitation" clause herein subject to the applicable law. The arbitration tribunal shall have the power to rule on any challenge to its jurisdiction or to the validity or enforceability of any portion of the Agreement to arbitrate. Any decision of the arbitrator shall be final and may be entered into any judgment in any court of competent jurisdiction. You waive the right to have your claim heard in a court of law and by a jury.

You waive the right to participate in class actions arising from or relating to all claims and disputes with Navimow Parties and/or Navimow Dealers. You agree to arbitrate solely on an individual basis and that this Agreement does not permit class arbitration or any claims brought as a plaintiff or class member in any class or representative arbitration proceeding. The arbitral tribunal may not consolidate more than one person's claims and may not otherwise preside over any form of a representative or class proceeding. If the prohibition on class arbitration is deemed invalid or unenforceable, then the remaining portions of the arbitration Agreement will remain in force.

Section 6 "Claims and Dispute Resolution" clause shall survive upon termination or expiration of this Agreement and/or limited warranty or in the event that this Agreement and/or the limited warranty is held as void, avoidable, invalid, or unenforceable, either in whole or part, by a competent adjudication institution with actual authority and jurisdiction over this matter.

Navimow Parties and Navimow Dealer require, and you hereby agree that you shall arbitrate your claims against Navimow

Parties and/or Navimow Dealers according to the arbitration described above before you exercise your rights according to the title of the Magnuson-Moss Warranty Act. Title I of the Magnuson-Moss Warranty Act does not require you to pursue rights and remedies available to you that are not provided by the Title I of Magnuson-Moss Warranty Act.

6.2 Small Claim

For any arbitration in which your total claims, exclusive of attorney fees and expert witness fees, is \$5,000.00 or less ("Small Claim"), the arbitrator may, if you prevail, award your reasonable attorney fees, expert witness fees, and costs as part of any award on the condition of the arbitrator's actual and affirmative finding that the claim is non-frivolous. In a Small Claim case, you are required to pay no more than half of the total administrative, facility, and arbitrator fees, or \$50.00 of such fees, whichever is less, and Navimow Parties shall pay the remainder of such fees. In a Small Claim case, Navimow Parties shall not recover any attorney fees provided that your claim is non-frivolous. Administrative, facility, and arbitrator fees for arbitrations in which your total claimed damages, exclusive of attorney fees and expert witness fees, exceed \$5,000.00 ("Large Claim"), shall be determined according to AAA Rules. In a Large Claim case, the arbitrator may grant to the prevailing party or apportion among the parties reasonable attorney fees, expert witness fees, and costs. The arbitrator shall be entitled to award declaratory or injunctive relief upon request by any party.

6.3 Opt-Out

YOU MAY OPT OUT OF THIS DISPUTE RESOLUTION PROCEDURE BY PROVIDING NOTICE TO NAVIMOW PARTIES NO LATER THAN THIRTY (30) CALENDAR DAYS AFTER THE DATE OF THE FIRST CONSUMER PURCHASER'S PURCHASE OF THE PRODUCT. TO OPT-OUT, YOU MUST SEND NOTICE BY EMAIL TO NAVIMOW AT OPTOUT@SEGWAY.COM, WITH THE SUBJECT LINE: "ARBITRATION OPT-OUT." THE OPT-OUT NOTICE BY E-MAIL MUST INCLUDE (A) YOUR NAME, EMAIL ADDRESS, MAILING ADDRESS, AND PHONE NUMBER; (B) THE DATE ON WHICH THE PRODUCT WAS PURCHASED; (C) THE PRODUCT MODEL NAME OR MODEL NUMBER; AND (D) THE SERIAL NUMBER. ALTERNATIVELY, YOU MAY OPT OUT BY SENDING AN ELECTION TO OPT-OUT LETTER TO NAVIMOW AT 98 Spit Brook Rd. Suite 2203, Nashua, New Hampshire, 03062. WITHIN THIRTY (30) CALENDAR DAYS FROM THE DATE OF THE FIRST END USER'S PURCHASE OF THE PRODUCT FROM NAVIMOW DEALER. THE OPT-OUT LETTER SHALL CONTAIN THE FOLLOWING INFORMATION: (A) YOUR NAME, EMAIL ADDRESS, MAILING ADDRESS, AND PHONE NUMBER; (B) THE DATE ON WHICH THE PRODUCT WAS PURCHASED; (C) THE PRODUCT MODEL NAME OR MODEL NUMBER; (D) THE SERIAL NUMBER; AND (E) AN STATEMENT AS FOLLOWS: THE ABOVE CONSUMER ELECTS TO OPT-OUT OF THE DISPUTE RESOLUTION PROCEDURE AS PROVIDED BY THIS LIMITED WARRANTY, THESE ARE THE ONLY TWO EFFECTIVE WAYS TO OPT-OUT OF THIS DISPUTE RESOLUTION PROCEDURE. ELECTION TO OPT-OUT THIS DISPUTE RESOLUTION PROCEDURE WILL NOT AFFECT THE COVERAGE OF THE LIMITED WARRANTY IN ANY WAY, AND YOU WILL CONTINUE TO ENJOY THE BENEFITS OF THE LIMITED WARRANTY.

6.4 Federal Arbitration Act

The Federal Arbitration Act governs this arbitration clause. This Agreement evidences a transaction in interstate commerce, and thus the Federal Arbitration Act governs its interpretation and enforcement.

6.5 Procedure

The Federal Arbitration Act governs this arbitration clause. This Agreement evidences a transaction in interstate commerce, and thus the Federal Arbitration Act governs its interpretation and enforcement.

The following is a description of the arbitration process:

- A. Mail a Notice of Dispute to Navimow. Before initiating an arbitration against Navimow Parties and/or Navimow Dealers, you must first notify Navimow Parties and/or Navimow Dealers of your dispute in good faith. Please include your contact information, your concerns, and the relief you intend to seek from Navimow Parties and/or Navimow Dealers, and any information you believe would help resolve the dispute. Navimow Parties and/or Navimow Dealers will review your Notice of Dispute to determine whether Navimow Parties and/or Navimow Dealers may settle it with you to avoid arbitration. The notice should be sent by certified mail to Attention: Disputes, NAVIMOW, 98 Spit Brook Rd. Suite 2203, Nashua, New Hampshire, 03062. Please keep a copy of your notice for your records.
- B. Wait 30 Days. Navimow Parties and/or Navimow Dealers will review your Notice of Dispute within thirty (30) days of Navimow's receipt of your Notice of Dispute. If you do not hear from Navimow within thirty (30) days of its receipt of your Notice of Dispute, you may proceed with filing an arbitration claim against Navimow Parties and/or Navimow Dealers. Should Navimow provide you a written settlement offer, please keep this settlement offer because Navimow Parties and/or Navimow Dealers and you will be required to show this settlement offer to the arbitrator. Notwithstanding the foregoing, such offer, if any, shall not be shown to the arbitrator until after the arbitrator's determination on the merits of your claim.
- C. Complete a Demand for Arbitration. You can initiate arbitration by completing a Demand for Arbitration that includes a basic statement of the (i) names and addresses and telephone numbers of the parties involved; (ii) your description of the dispute; and (iii) your short statement detailing why you are entitled to relief.
- D. Send Navimow Parties and/or Navimow Dealers Your Demand for Arbitration. You can send Navimow Parties and/or Navimow Dealers your Demand for Arbitration at the following address: Attention: Disputes, NAVIMOW, 98 Spit Brook Rd. Suite 2203, Nashua, New Hampshire, 03062. Please keep a copy of your notice for your records.
- E. Send AAA Two (2) Copies of Your Demand for Arbitration. The Demand for Arbitration includes the address that you are to send two (2) copies of your Demand for Arbitration. This address is AAA Case Filing Services at 1101 Laurel Oak Road, Suite 100, Voorhees, NJ 08043, subject to amendment and/or update by AAA. You should also include a copy of this warranty policy and the appropriate filing fee. Navimow Parties will reimburse you for this filing fee. If you cannot afford to pay the filing fee, please contact Navimow, and Navimow will pay the filing fee for you if your claims seek a remedy less than \$75,000. AAA has an online filing option that you can find on its website: www.adr.org.

- F. AAA Appointment of Arbitrator. If no claim in the arbitration exceeds \$75,000, the AAA will appoint an arbitrator and notify you and Navimow Parties and/or Navimow Dealers of the arbitrator's name and qualification. The AAA requires all arbitrators to check for any past or present relationships with the parties, potential witnesses, and the parties' attorneys. If the arbitrator has any such relationship, the AAA will inform Navimow Parties and you. If either you or Navimow Parties object to the AAA's choice of arbitrator, we'll have seven (7) days to inform the AAA.
- G. Choose the Hearing You Would Like. Unless you and Navimow Parties agree to have any arbitration hearings somewhere else, the arbitration will take place in the county (or parish) that you purchase the Product. If your claim is for \$10,000 or less, you may choose to have the hearing conducted by telephone or in-person. Alternatively, you may choose to proceed to conduct the entire arbitration through written correspondence with the arbitrator that doesn't include an interactive hearing. Once the AAA has commenced the arbitration, you have ten (10) days to inform the AAA of your choice of hearing. If you don't make a choice, the AAA will conduct the arbitration by written correspondence without an interactive hearing. If your claim exceeds \$10,000, the right to a hearing will be determined by the AAA Rules. Those rules currently provide for an in-person hearing if your claim exceeds \$10,000, but you and Navimow Parties may agree whether that hearing is in person or by telephone or whether to instead proceed with written correspondence.
- H. Arbitrator's Decision. Within fourteen (14) days from the conclusion of the in-person or telephone hearing, or from the submission of all written evidence to the arbitrator if you have elected to conduct the arbitration through written correspondence, the arbitrator will render a written decision. That decision will include the essential findings and conclusions upon which the arbitrator based his or her award. Navimow Parties will immediately respond to the arbitrator notifying the arbitrator whether, and to what extent, Navimow Parties will abide by the decision, perform the obligations it has agreed to do. Any decision by the arbitrator may be utilized by any party for any reason.
- I. The parties agree to keep strictly confidential any conduct, communication, and information disclosed and/or communicated to the other party under Section 6 (Claims, Dispute Resolution and Mandatory arbitration), including but not limited to the existence of dispute resolution, mediation (if the parties agree to conduct mediation), settlement, arbitration, arbitral proceedings, submissions made by the parties and the decisions made by arbitral tribunal, including its awards to the extent not already in the public domain, except in judicial proceedings related to the award or where required by applicable law.

7. Intended Third-Party Beneficiary

(a) If a natural person receives a Product that is new as a gift from its original purchaser and this recipient does not become a party to this Agreement, this recipient shall be deemed as an intended third-party beneficiary to this Agreement. (b) If (i) a natural person is in the family or household of a purchaser of Product, (ii) it is reasonable to expect that such person may use, consume, or be affected by the Product, and (iii) this person is not a party to this Agreement, this person shall be deemed as an intended third-party beneficiary to this Agreement.

8. Statute of Limitation

The parties agree that any dispute, controversy, or claim arising out of, related to, or in connection with this Agreement, the limited warranty, the sale, condition, or performance of the Product, whether based in contract, tort, fraud, misrepresentation or any other legal theory at law or in equity, including but not limited to any claims for death, injury or property damages, must be commenced within one year after the cause of action has occurred.

9. Severability

If any term, clause, or provision of this Agreement is invalid, illegal or unenforceable in any jurisdiction, such invalidity, illegality, or unenforceability shall not affect any other term, clause or provision of this Agreement or invalidate or render unenforceable such term, clause or provision in any other jurisdiction. Upon a determination that any term, clause, or provision is invalid, illegal, or unenforceable, the parties shall negotiate in good faith, and if negotiation fails, the arbitral tribunal may modify this Agreement to give effect to the original intent of the parties as closely as possible in order that the transactions contemplated hereby be consummated as originally contemplated to the greatest extent possible.

10. Language

This Agreement may be translated into different languages. In the event of a conflict, the English version shall prevail and control.

7. Contact Us

7.1 Contacts in Europe

Manufacturer: Willand (Beijing) Technology Co., LTD.

Address: Room 203, A-1 Bldg. Zhongguancun Dongsheng Technology Park (Northern Territory), No. 66, Xixiaokou Rd, Haidian Dist., Beijing, China.

Email: support-navimow@rlm.segway.com

Europe Authorised representative: AR Experts B.V., P.O. Box 5047, 3620 AA Breukelen, The Netherlands

Website: navimow.segway.com

Email: info@certification-experts.com

Contact us if you experience issues relating to the operation, maintenance and safety, or errors/faults with your mower.

7.2 Contacts in North America

Manufacturer: Willand (Beijing) Technology Co., LTD.

Address: Room 203, A-1 Bldg. Zhongguancun Dongsheng Technology Park (Northern Territory), No. 66, Xixiaokou Rd, Haidian Dist., Beijing, China.

Manufactured for: Navimow Inc.

Address: 98 Spit Brook Rd. Suite 2203, Nashua, New Hampshire 03062, USA

Email: support-navimow@rlm.segway.com

Website: navimow.segway.com

Contact us if you experience issues relating to the operation, maintenance and safety, or errors/faults with your mower.

NAVIMOW