

# Tera



## PORTABLE EV CHARGER USER MANUAL

(Version : 1.0)



Please do not hesitate to contact us if you have any questions.

**Important Notice**

Please include your Order Number and Product Model Number in the email.

**Official Customer Service**

**Email Address:** [cs@tera-innovation.com](mailto:cs@tera-innovation.com)

**Cell:** +1 (626)438-1404 / +1 (909)242-8669

**Whatsapp:** +1 (626)438-1404



## CONTENTS

1. Safety Tips.....	2
2. Important Information.....	3
2.1 Specified Use.....	3
2.2 About This Manual.....	3
3. Use of Products.....	4
3.1 Product Appearance Size.....	4
3.2 Product Appearance Introduction.....	4
3.3 Product Performance Description.....	5
3.4 LED Indicator Instruction.....	6
3.5 Equipment Parts List.....	6
4. Operation Guide.....	7
4.1 Operation Steps.....	7
4.2 Steps For Adding APP Device.....	9
5. Wallbox Installation Method.....	11
5.1 Wallbox Rendering.....	11
5.2 Fixing Cover Installation Drawing.....	11
5.3 Gun Holder Installation Drawing.....	12
5.4 Installation Environment Requirements.....	12
5.5 Power Supply Requirements.....	12
6. Troubleshooting.....	13
6.1 Troubleshooting Table.....	13
7. Maintenance.....	15
7.1 Maintenance.....	15
7.2 Important Matters.....	15

# 1. SAFETY TIPS

---



## IMPORTANT SAFETY INSTRUCTIONS

**WARNING:** This manual contains important instructions for AC charger series that shall be followed during installation, operation and maintenance of the unit.

- a. Read all the instructions before using this product;
- b. This device should be supervised when used around children;
- c. Do not put fingers into the electric vehicle connector;
- d. Do not use the product when the charging cable has been damaged or frayed;
- e. Do not use this product if the enclosure or the EV connector is broken, cracked, open, or shows any other indication of damage;
- f. The whole installation should be operated by qualified professional electrician;
- g. Be careful! Any incorrect operation may cause life danger, injury or equipment damage. The manufacturer would refuse to accept any claim arising therefrom. Please make sure this instruction manual is fully understood and the specified conditions are met before any operations of the EV charger;
- h. Please do not operate under any circumstances that may cause electric leakage;
- i. Changes or modifications to this unit not expressly approved by the part responsible for compliance could void the user's authority to operate the equipment;
- j. This equipment complies with FCC radiation exposure limits set forth for an rolled environment. This equipment should be installed and operated with a minimum distance of 20cm between the radiator and your body.

**SAVE THESE INSTRUCTIONS**

## 2. IMPORTANT INFORMATION

---

### 2.1 Specified Use

- This type of product is a charger that can charge electric vehicles in indoor and outdoor areas;
- When installing and connecting the charger, the relevant regulations of the local country or government shall be observed;
- The specified use of the equipment includes complying with the environmental conditions under any circumstances;
  - ★ During the storage or use of the equipment, it is necessary to store the charger and its supporting components in a dry and ventilated indoor place with a temperature of  $-22^{\circ}\text{F}\sim+122^{\circ}\text{F}$  and a daily average temperature of  $\leq 95^{\circ}\text{F}$  within 24 hours;
  - ★ Monthly average relative humidity  $\leq 90\%$  ( $77^{\circ}\text{F}$ ), no condensation on the surface;
  - ★ After the installation, the shell of the charger shall be kept sealed to avoid soaking in rain;
  - ★ The place of use shall be free of explosive media, the surrounding media shall not contain harmful gases and conductive media that corrode metals and damage insulation, and shall not be filled with steam or serious mold;
  - ★ The place of use should avoid direct sunlight. When installing outdoors, it is recommended to install sunshade facilities for the charger;
- When the AC charger is not in use, the charging gun shall be placed 19.69 inches ~ 59.06 inches away from the ground;
- Equipment shall be developed, produced, inspected and filed according to relevant safety standards. Therefore, there will be no unnecessary property loss or personnel danger, if the instructions and safety standards are followed strictly;
- The instructions contained in this manual must be strictly followed, otherwise potential safety hazards may occur or the built-in protection devices may fail. Although this manual describes the relevant safety tips, it is still necessary to pay attention to the safety regulations and accident prevention regulations in accordance with the corresponding application;
- Due to technical or legal restrictions, it is impossible to supply all models/options to the region;
- For any special requirements, pls feel free to contact us.

### 2.2 About This Manual

- This manual is applicable to the following groups:
  - ★EV Charger User
  - ★ The technical staff of debugging and service
- The final explanation of this manual belongs to the company.

### 3. USE OF PRODUCTS

#### 3.1 Product Appearance Size

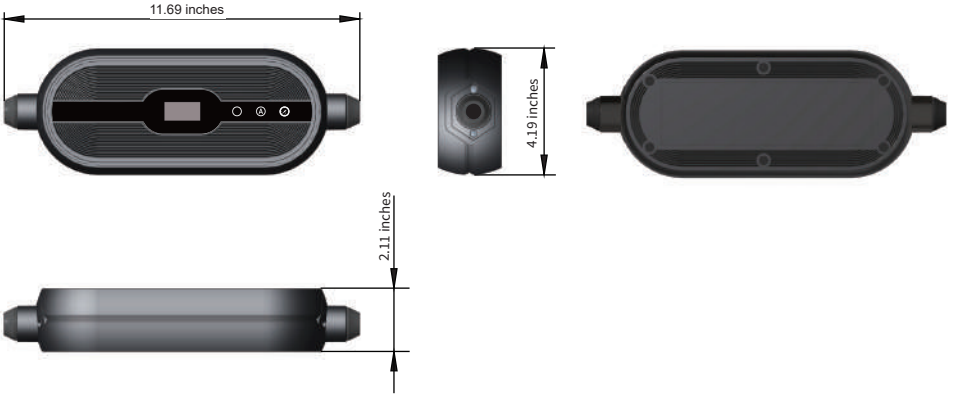

#### 3.2 Product Appearance Introduction

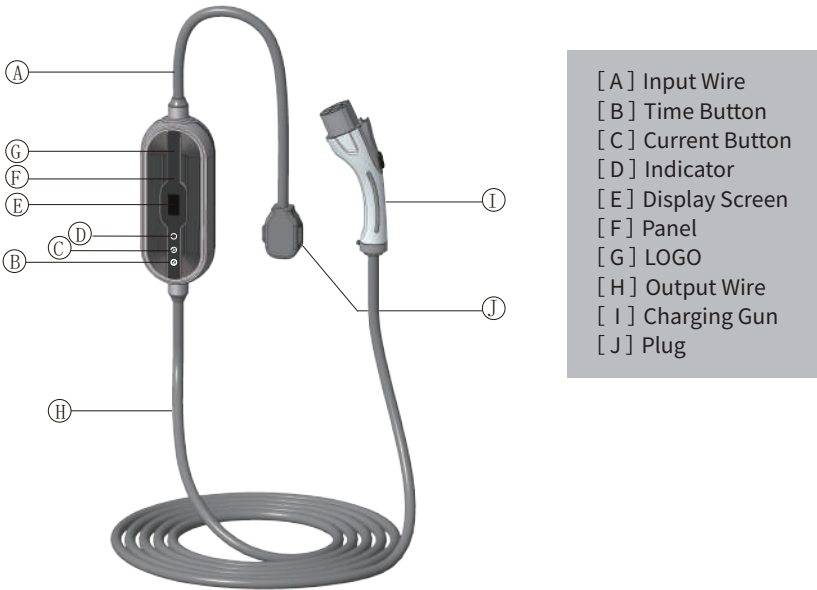

### 3. USE OF PRODUCTS

#### 3.3 Product Performance Description

Product Characteristics	
Output Power	7kW
Operating Current	32 A (Max)
Current Adjustability	16A-20A-24A-32A
Installation Method	Portable/Wallbox
Operating Voltage	L1 /L2 /PE;240 Vac(±15 %)
Operating Frequency	60Hz±1Hz
Cable Length	25FT
AC Input Plug	NEMA 14-50P
Connector Type	SAE J1772
Indicator	4-Color Indicator
User Interface	1.3inches OLED Screen
Charging Method	Plug & Play + APP Charging
Communication Method	WiFi & Bluetooth
Appearance Size	11.69 x 4.19 x 2.11 inches
Product Weight	< 9.26 pounds
Protection Characteristics	
Over Voltage Protection	Input Voltage>120 %, relay is off
Under Voltage Protection	Input Voltage<80 %, relay is off
Over Load Protection	Output Current>110 %, relay disconnected, the power supply needed to be cut off and restored
Over Temperature Protection	When the temperature of the main board reached 185°F , the power was reduced to 50%, and it was turned off after 194°F
Ground Protection	The ground wire is not detected or the ground wire is disconnected during charging. The relay is disconnected.
Leakage Protection	CCID20, leakage, the relay was off
Reliability	
MTBF	100,000 Hours
Safety Standard	UL2594, UL2231-1/-2, UL1998, UL991, UL2251

### 3. USE OF PRODUCTS

---

Environment Characteristics	
Operating Temperature	-22°F~+122°F
Storage Temperature	-31°F~+176°F
Operating Humidity	5 % ~ 95 % RH
Operating Altitude	Less Than 6,562 Feet
Protection Level	TYPE 4
Protection Degree	IP66

#### 3.4 LED Indicator Instruction

No.	Charging Status	Indicator Color	Indicator Status
1	Standby	Blue	Always on
2	Insert the Plug	Green	Always on
3	Charging	Green	Flashing
4	C P Abnormal	Red	Always on
5	Over voltage/Under voltage	Red	Flashes once every 1S
6	Ground Fault	Red	Flashes once every 2S
7	Over-current Protection	Red	Flashes once every 4S
8	Leakage Protection	Purple	Flashes once every 1S
9	Over-temperature Protection	Purple	Flashes once every 2S

#### 3.5 Equipment Parts List

No.	Equipment Parts	Quantity
1	AC Charging Pile	1
2	Fixing Cover	1
3	Gun Holder	1
4	Portable Handbag	1
5	Screw	7
6	Expandable Rubber Stopper	7
7	User Manual	1

# 4. OPERATION GUIDE

## 4.1 Operation Steps

- 1 Plug the charger into the socket

### Specification of Switch and Socket

Power	Current	Switch/Socket
7kW	32A(Max)	40A(2P leakage protector)/32A Socket

For power safety, add overcurrent protection device/circuit breaker at the product input.

### GROUNDING INSTRUCTIONS

This product must be grounded. If it should malfunction or break down, grounding provides a path of least resistance for electric current to reduce the risk of electric shock. This product is equipped with a cord having an equipment grounding conductor and a grounding plug. The plug must be plugged into an appropriate outlet that is properly installed and grounded in accordance with all local codes and ordinances.



### WARNING

Improper connection of the equipment grounding conductor is able to result in a risk of electric shock. Check with a qualified electrician or serviceman if you are in doubt as to whether the product is properly grounded. Do not modify the plug provided with the product if it will not fit the outlet, have a proper outlet installed by a qualified electrician.

**2** Adjust charging parameter

- Free
- Connect
- Charge

Operating Status

Operating Temperature

Operating Voltage

Power Quantity

Adjust charging time according to personal time.

Adjust the charging current according to the power supply current of the socket

Time Button (adjust reservation time)

Indicator

Current Button (Adjust current level)  
Long press to switch charge mode

78°F	Free	32A	( 16 A, 20 A, 24 A, 32 A)
240V	00.00A		
Power	00.00kwh		
Delay	00:00:00		Set the charging delay

## 4. OPERATION GUIDE

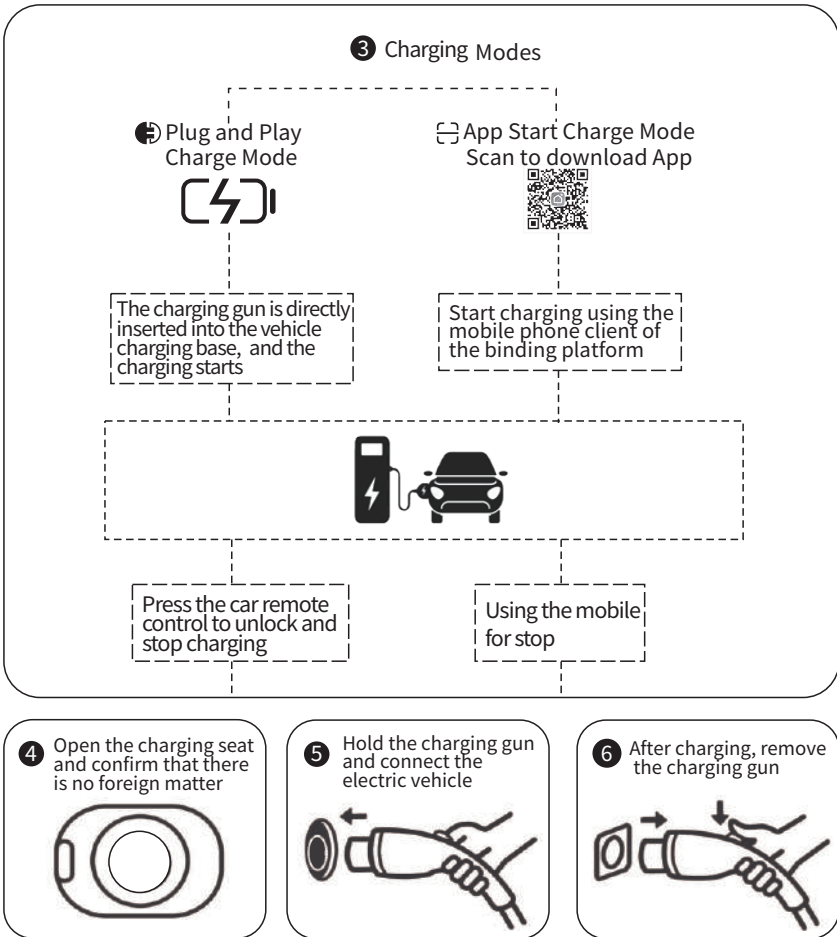

## 4. OPERATION GUIDE

### 4.2 Steps For Adding APP Device

#### Download Method

For IOS: Search Smart Life in the Apple Store to download and install it.

For Android: Search Smart Life in the Google Store to download and install it.



#### Step 1:

**Add Device**  
Click "Add Device".



#### Step 2:

**Connect the WIFI**  
When adding a device for the first time, connect the device and mobile phone under the same WIFI .



#### Step 3:

**Loading**  
Wait until the device is loaded.

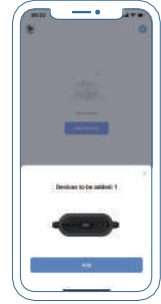

#### Step 4:

**Loading Completed**  
After loading, click "Add to enter the charging interface".

#### Tips:

Only when the device is added for the first time, the device and mobile phone need to be connected under the same WIFI. After the device is loaded, you only need to turn on Bluetooth to connect the device again.

#### 4.2.1 APP Current Switch Step



#### Step 1:

**Setting**  
Click on the "Setting" TAB.



#### Step 2:

**Charging Current**  
Click on charging current to switch from 0/16/20/24/32A.

## 4. OPERATION GUIDE

---

### 4.2.2 Steps for APP Appointment Time



**Step 1:**  
Click Charging Mode.



**Step 2:**  
Click Delay Charging.



**Step 3:**  
Select the delay  
time (1-12 hours).

#### Tips:

Hold down the current and time button at the same time to reset wifi.

### 4.2.3 Charging Instructions on APP



**Instructions 1:**  
Swipe Right To Charge  
Insert the charging plug  
into the charging port,  
“Swipe right to charge”.



**Instructions 2:**  
Charging Record  
Users' charging history  
can be viewed in the APP.

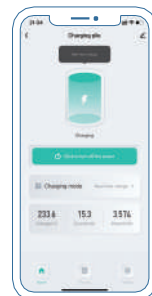

**Instructions 3:**  
Charging Completed  
After charging, click  
to turn off the power.

## 5. WALLBOX INSTALLATION METHOD

### 5.1 Wallbox Rendering

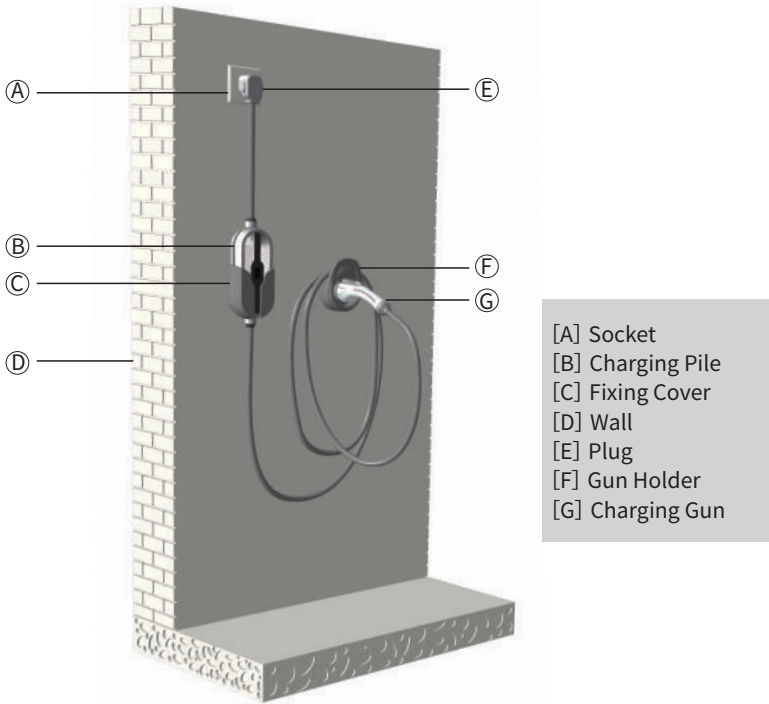

### 5.2 Fixing Cover Installation Drawing

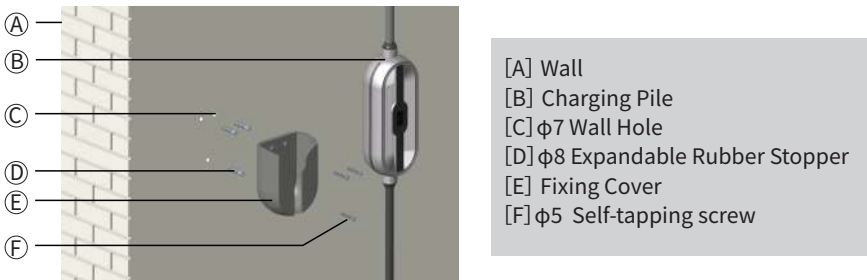

● As shown in the above figure, place the fixing cover on the wall at a proper height, mark the hole location on the wall with a pencil, and use an impact drill to drill three  $\phi 7$  holes on the wall according to the hole marking, and drill three  $\phi 8$  expansion rubber plugs in the three holes. Finally, place the wall hanging shell on the wall, align the fixing holes of the fixing cover with the wall holes, and fasten them with  $\phi 5$  tapping screws.

## 5. WALLBOX INSTALLATION METHOD

### 5.3 Gun Holder Installation Drawing

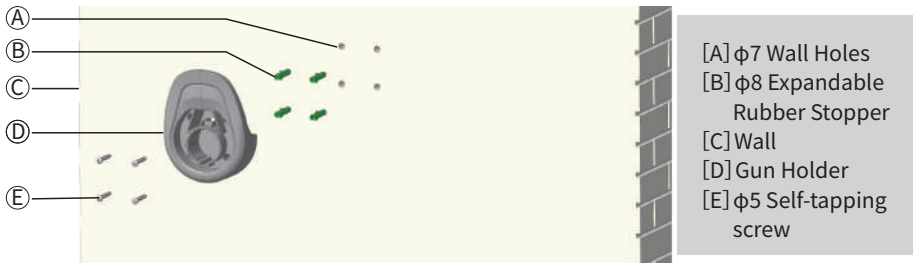

● As shown in the above figure, place the gun holder on the wall at a proper height, mark the hole location on the wall with a pencil, and use an impact drill to drill four  $\phi 7$  holes on the wall according to the hole marking, and drill four  $\phi 8$  expansion rubber plugs in the four holes. Finally, place the gun holder on the wall, align the fixing holes of the gun holder with the wall holes, and fasten them with  $\phi 5$  tapping screws.

### 5.4 Installation Environment Requirements

- The installation position of the charger shall not be close to dangerous locations or areas such as water, oil and gas pipelines;
- The installation position shall be convenient for charging, the wiring length shall be shortened to reduce the energy consumption of cable resistance when laying lines;
- The wall hanging parts and shall be fixed with screws. The installation wall shall be able to bear the gravity of the charger and its accessories, and shall not tilt after installation. The wall should not be too close to the internal line;
- The protection degree for indoor installation shall be at least TYPE 4, and that for outdoor installation shall be at least TYPE 4. It is recommended that the charger be installed in an environment with sunshade or umbrella; The lighting and passage at the installation site of the charger must be safe and smooth;
- A certain operating space shall be reserved for the installation of charger to facilitate the overhaul and maintenance of engineering personnel;
- It is recommended that the customer install a circuit breaker at the front end of the charger. The mini circuit breaker should meet local regulations.

### 5.5 Power Supply Requirements

The power supply mode of the portable AC charger is AC single-phase power supply, and the input electrical requirements are:

- AC Operating Voltage: Refer to page 5;
- AC Operating Frequency: Refer to page 5;
- The capacity of the power supply system shall be greater than the maximum operating power of the product;
- For the specification of power socket, please refer to Specification and Configuration Table of Switch Socket on page 8.

## 6. TROUBLESHOOTING

### 6.1 Troubleshooting Table

Failure	Causes and Solutions
Unable to turn on	<ul style="list-style-type: none"><li>● Check the power supply and cables to ensure that they are not damaged in any way and are properly connected and that the power supply is properly powered.</li><li>● If you cannot resolve the problem, please contact a service partner.</li></ul>
Unable to start charging	<ul style="list-style-type: none"><li>● Check the vehicle connector to make sure there is no foreign matter inside the gun, the cable is not damaged, and the vehicle connector and socket are in good contact.</li><li>● Check the unlock button to make sure it is locked and that the vehicle is set up properly.</li><li>● Touched the delayed charging button by mistake.</li><li>● Your EV charger is "APP Start" charging mode: Pull out the charging gun, long press the "A" button to switch to "Plug and Play" mode.</li></ul>
Incomplete charge or overtime charge	<ul style="list-style-type: none"><li>● High temperatures can cause current derating or interrupt charging process.</li><li>● Overvoltage or undervoltage may cause interruption of charging.</li><li>● Poor grounding leads to incomplete product protection charging.</li></ul>
The screen displays "CP Fault"	<ul style="list-style-type: none"><li>● Please restart the device to charge.</li><li>● If you cannot solve the problem, please contact the service partner.</li></ul>
The phone cannot find the device	<ul style="list-style-type: none"><li>● The frequency band of the phone and the device do not match (must be connected via the same 2.4 GHz WIFI).</li><li>● If the device is already tied to another phone. New phones cannot be added. If necessary. To restore factory settings: Press the Current button and Timer button at the same time until the screen displays 'WIFI reset' and the white light flashes.</li></ul>
The screen displays "Overvoltage fault"	<ul style="list-style-type: none"><li>● Indicates that the charger input voltage is higher than the limit value 288Vac(max).</li><li>● Contact an electrician to confirm whether the supply voltage is normal</li><li>● If you cannot solve the problem, please contact the service partner.</li></ul>

## 6. TROUBLESHOOTING

---

Failure	Causes and Solutions
The screen displays "Low voltage fault"	<ul style="list-style-type: none"><li>● Indicates that the charger input voltage is below the limit 192Vac(min).</li><li>● Contact an electrician to confirm that the supply voltage is normal.</li><li>● Please check whether the power supply load capacity is sufficient.</li><li>● If you cannot solve the problem, please contact the service partner.</li></ul>
The screen displays "Ground fault"	<ul style="list-style-type: none"><li>● Check whether the ground status of the power supply socket is valid.</li></ul>
The screen displays "Overcurrent fault"	<ul style="list-style-type: none"><li>● Please make sure that the vehicle charging current is within the rated range.</li><li>● If you cannot solve the problem, please contact the service partner.</li></ul>
The screen displays "Over Temperature fault"	<ul style="list-style-type: none"><li>● Stop charging and leave it for 30 minutes before starting charging again.</li><li>● If you cannot resolve the problem, please contact the service partner.</li></ul>
Button not responding	<ul style="list-style-type: none"><li>● You can operate the screen button before inserting the gun, and the button will be locked and not respond after inserting the gun.</li><li>● Please contact the service partner.</li></ul>
Show "no plug" does not charge?	<ul style="list-style-type: none"><li>● Avoid fast and frequent plugging and unplugging.</li><li>● Maybe vehicle problem, contact after-sale service.</li></ul>

(\* Possible fault causes (fault status LED lights up):

In principle, the fault must be cleared by pulling out the charging gun. The following reasons may lead to failure: Ground fault, electric leakage, charger pile ID not set. Please contact your service partner to maintain the equipment.

# 7. MAINTENANCE

## 7.1 Maintenance

- The following routine maintenance items are only for reference, please refer to relevant standards and operation instructions for operation;
- Sunshade and rainproof measures shall be taken for the charging pile, and it is recommended to install a canopy outdoors;
- Regularly check whether the bolts of the charging pile are fastened, whether the connecting wire is loose, and whether the connection is not firm, and check whether there is short circuit;
- Pay attention to lightning protection and ensure effective shielding and reliable grounding of the charging pile;
- When using, try to control the output voltage and current of the charging pile within the nominal range, so as to ensure that the charging pile can work with the maximum efficiency;
- When the charging pile is out of service, the charging output shall be stopped first, then the power plug shall be pulled out and the power shall be cut off, then the cable shall be wound, and the charging pile shall be put back to its original position after the temperature of the charging pile drops to normal temperature;
- The electrical schematic diagram of the charging pile is shown in the figure below.

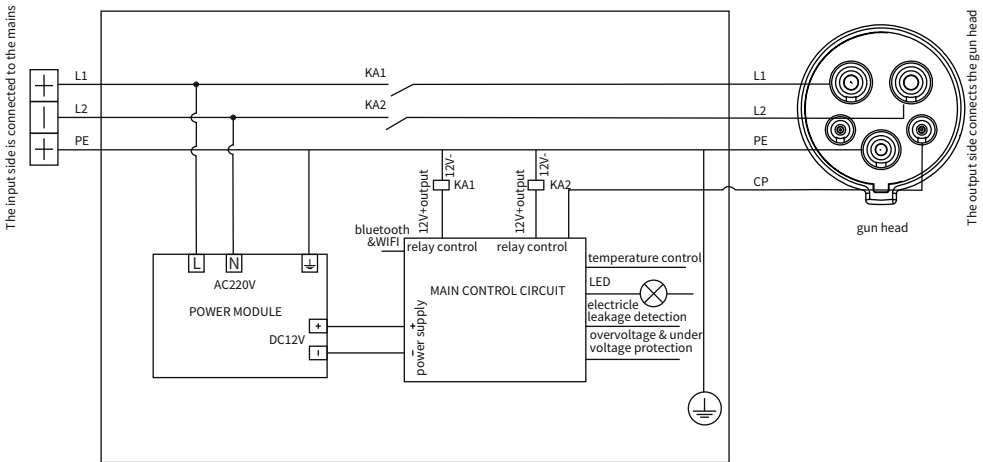

## 7.2 Important Matters

- To ensure that you can enjoy the warranty service, please ensure that the tear-proof label on your charging pile is intact.

## 7. MAINTENANCE

---



### NOTICE

- a. The charger must be grounded through the grounding conductor of the permanent wiring system or equipment;
- b. Please avoid installing in the direct sunlight or exposure environment, and try to use the charger in a cool and ventilated place;
- c. Do not install and use the charger near flammable, explosive, combustible and chemical substances or steam;
- d. Before installing or cleaning the charger, the power supply must be cut off to ensure that there is no power input. Do not touch the heat source, dirt or water source on the contact surface;
- e. Please use the charger within the specified working parameters;
- f. Only connect electric vehicles. Do not connect other loads (electric tools, etc.). Do not use the charger for other purposes than charging or other vehicles that do not support the AC charger standard of the country where the product is located;
- g. The charger must be checked regularly. If it is found to be defective, cracked, worn, damaged and inoperable, the charger shall be stopped immediately and the after-sales service telephone shall be called;
- h. Do not attempt to open, disassemble, modify or transform the charger without a professional electrician. The charger is not a device that can be maintained by users. Do not remove safety symbols, warning prompts, nameplates, signs or pipeline marks;
- i. If you or your car are exposed to rainstorm, lightning, heavy snow or other severe weather conditions, do not use the charger to prevent any parts from being damaged;
- j. Please handle with care when transporting the charger. Do not subject it to strong external force impact, and do not drag, twist or step on the charger and cable to prevent damage to any parts. At any time, please avoid and prevent the charger from being damaged by moisture, liquid and other foreign matters. If there is water, damage or corrosion, please do not use it. Do not touch or charge the cable and charging gun head with wires, tools or other sharp hard objects;
- k. If your EV is covered with a car cover or a car coat, please remove it before charging the car;
- l. Users may affect or impair the function of the charger during usage if he/she wears any medical or implantable electronic device, such as cardiac defibrillators, pacemakers, etc;
- m. During transportation, there should be no severe vibration, impact, exposure to sunlight, rain, or dumping of the charging pile.

