

<b>PRECAUTIONS</b>	<b>35</b>	Microwaves	44
General safety instructions	35	<b>USE</b>	<b>44</b>
For this appliance	40	Preliminary operations	44
Appliance purpose	40	Materials suitable for use with microwaves	45
This user manual	41	Using the accessories	45
Manufacturer's liability	41	Digital programmer	46
Identification plate	41	Using the oven	47
Disposal	41	Cooking advice	52
To save energy	41	Discover the recipes	52
Light sources	41	Settings	55
How to read the user manual	42	<b>CLEANING AND MAINTENANCE</b>	<b>57</b>
<b>DESCRIPTION</b>	<b>42</b>	Cleaning the appliance	57
General Description	42	Cleaning the door	57
Control panel	43	Cleaning the oven cavity	58
Other parts	43	Extraordinary maintenance	59
Accessories	44	<b>INSTALLATION</b>	<b>59</b>
Optional accessories (can be purchased separately)	44	Electrical connection	59
		Positioning	60

We advise you to read this manual carefully, which contains all the instructions for maintaining the appliance's aesthetic and functional qualities. For further information on the product: [www.smeg.com](http://www.smeg.com)

## PRECAUTIONS

### IMPORTANT SAFETY INSTRUCTIONS

#### PLEASE READ CAREFULLY AND RETAIN FOR FUTURE USE

#### General safety instructions

##### Risk of personal injury

- **ATTENTION:** during use, the appliance and its accessible parts become very hot. Children must be kept away from the appliance.
- **ATTENTION:** during use, the appliance and its accessible parts become very hot. Never touch the heating elements during use.
- Protect your hands by wearing oven gloves when moving food inside the oven.
- Never try to put out a fire or flames with water: turn off the appliance and smother the flames with a fire blanket or other appropriate cover.
- This appliance may be used by children aged at least 8 and by people of reduced physical, sensory or mental capacity, or lacking in experience in the use of electrical appliances, provided that they are supervised or instructed by adults who are responsible for their safety.
- Children must not play with the appliance.

- Keep children under the age of 8 at a safe distance unless they are constantly supervised.
- Keep children under the age of 8 away from the appliance when it is in use.
- Cleaning and maintenance must not be carried out by unsupervised children.
- The cooking process must always be monitored. A short cooking process must be continuously surveyed.
- Never leave the appliance unattended during cooking operations where fats or oils could be released, as these could then heat up and catch fire. Be very careful.
- Do not pour water directly onto very hot trays.
- Keep the oven door closed during cooking.
- If you need to move food or at the end of cooking, open the door 5 cm for a few seconds, let the steam come out, then open it fully.
- Do not insert pointed metal objects (cutlery or utensils) into the slots in the appliance.
- Switch off the appliance immediately after use.
- **DO NOT USE OR STORE FLAMMABLE MATERIALS NEAR THE APPLIANCE.**
- **DO NOT USE AEROSOLS IN THE VICINITY OF THIS APPLIANCE WHILST IT IS IN**

USE.

- **DO NOT MODIFY THIS APPLIANCE.**
- Installation and servicing should be carried out by qualified personnel in accordance with current standards.
- Do not try to repair the appliance yourself or without the assistance of a qualified technician.
- Do not pull the cable to unplug the appliance.

### **For microwave appliances**

- **WARNING:** If the door or the door seal is damaged, the appliance must not be used until it has been repaired by a qualified person.
- **WARNING:** It is hazardous for anyone other than a competent person to carry out any service or repair operation which involves the removal of a cover which offers protection against exposure to microwave energy.
- **WARNING:** Liquids and other foods must not be heated in sealed containers since they are liable to explode.
- When a combined function is used, children should use the appliance only when supervised by an adult, as very high temperatures are generated.
- Check the appliance visually during the cooking of foods in

plastic or paper containers.



Improper use  
Danger of explosion



- When using the microwave to heat or reheat liquids, the boiling process may be delayed – boiling temperature can be reached without the formation of the usual "rolling boil".
  - This delayed boiling and consequent superheating of the liquid can generate an explosion inside the appliance, or sudden boiling over of the superheated liquid can occur when removing the container from the appliance.
  - To avoid these dangers, it is necessary to insert the supplied boiling rod (or a heat-resistant plastic spoon) in the container while heating.
  - Use the microwave only for the preparation of food for consumption. Other types of applications are strictly forbidden (e.g. drying clothes, warming slippers, sponges, wet cloths or the like, dehydrating foods) because they can lead to the risk of injury or fire.
- Microwave heating of beverages can cause delayed eruptive boiling, so care must be taken when handling the container.
  - Clean the appliance constantly and remove any food residue.
  - Failure to clean the oven cavity encourages deterioration of the surface, which could adversely affect the life of the appliance and possibly lead to a dangerous situation.
  - Do not use the microwave to dry food.
  - Do not use the microwave to heat oils or fry.
  - Do not use the appliance to heat foods or beverages containing alcohol.
  - Do not heat eggs in their shells or whole hard boiled eggs; they may explode even after the heating process has completed.
  - Do not heat food contained in food packages.
  - Do not use the combination functions to heat or boil liquids.
  - Baby food should not be heated in sealed containers. Remove the cover or the teat (in the case of baby bottles). Always check the temperature of the preparation after it has been heated, it should not be too high. For an even

temperature and to avoid scalding stir or shake the contents.

- Puncture the skin of food that has a hard skin or peel (e.g. potatoes, apples, etc.) before cooking.
- Do not use the microwave functions when the oven is empty.
- Use kitchenware and utensils that are suitable for use in a microwave oven.
- Do not use aluminium containers to cook food.
- Do not use metal containers for cooking food or beverages.
- Do not use dishes with metallic decorations (gold-plated or silver).
- If present, do not use the tray and/or deep tray for microwave cooking ONLY.
- If smoke is present, switch off or unplug the appliance from the power socket and keep the door closed to smother any flames.
- This appliance complies with the current standards and directives regarding safety and electromagnetic compatibility. However, it is recommended that people who wear pacemakers maintain a minimum distance of 20-30 cm between the pacemaker and the microwave oven when it is in operation. Contact the

pacemaker manufacturer for further information.

- The appliance operates in the 2.4 GHz ISM band.
- In compliance with the provisions regarding electromagnetic compatibility, the appliance belongs to group 2 and class B (EN 55011).

 **Improper use**  
**Risk of damage to the appliance**



- When using the microwave, the food (or its container) must not be placed on the bottom of the oven cavity. Use the supplied accessories inserted in the shelves suitable for the recipe you want to make.
- **DO NOT USE CONTAINERS/ ACCESSORIES (trays, glass dishes, etc.) RESTING DIRECTLY ON THE BOTTOM OF THE OVEN CAVITY.**

- If the appliance is installed in a cabinet, it must be operated with any cabinet door open.

### **Risk of damaging the appliance**

- Do not use abrasive or corrosive detergents (e.g. scouring powders, stain removers and metallic

sponges), rough or abrasive materials or sharp metal scrapers on glass parts as this could cause scratch the surface and break the glass. Use wooden or plastic utensils.

- Do not sit on the appliance.
- Do not use cleaning products containing chlorine, ammonia or bleach on parts made of steel or that have metallic surface finishes (e.g. anodizing, nickel- or chromium-plating).
- Racks and trays should be inserted as far as they will go into the side guides. The mechanical safety locks that prevent them from being removed must face downwards and towards the back of the oven cavity.

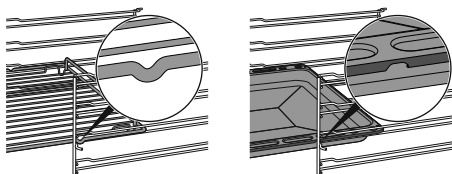

- Do not use steam jets to clean the appliance.
- Do not spray any spray product near the appliance.
- Do not obstruct ventilation openings and heat dispersal slots.
- Fire hazard: never leave objects in the oven cavity.
- **DO NOT FOR ANY REASON USE THE APPLIANCE AS A SPACE HEATER.**
- Do not use plastic cookware or

containers when cooking food.

- Do not place sealed tins or containers in the oven cavity.
- Remove all trays and racks which are not required during cooking.
- Do not cover the bottom of the oven cavity with aluminium or tin foil sheets.
- Do not place pans or trays directly on the bottom of the oven cavity.
- If necessary, you can use the tray rack (supplied or sold separately, depending on the model) by placing it on the bottom as a support for cooking.
- If you wish to use greaseproof paper, place it so that it will not interfere with the hot air circulation inside the oven cavity.
- Do not use the open door to rest pans or trays on the internal glass pane.
- Never use the oven door to lever the appliance into place when fitting.
- Avoid exerting too much pressure on the door when open.
- Do not use the handle to lift or move this appliance.

### Installation and maintenance

- **THIS APPLIANCE MUST NOT BE INSTALLED IN A BOAT OR CARAVAN.**

- The appliance must not be installed on a pedestal.
- Position the appliance into the cabinet cut-out with the help of a second person.
- To prevent any possible overheating, the appliance should not be installed behind a decoration door or a panel.
- Installation and servicing should be carried out by qualified personnel in accordance with current standards.
- Have the electrical connection performed by authorised technical personnel.
- The appliance must be connected to ground in compliance with electrical system safety standards.
- Use cables withstanding a temperature of at least 90 °C.
- The tightening torque of the screws of the terminal supply wires must be 1.5 - 2 Nm.
- If the power cable becomes damaged, contact technical support immediately to arrange for it to be replaced in order to avoid possible hazards.
- Always use any necessary/required personal protective equipment (PPE) before performing any work on the appliance (installation, maintenance, positioning or movement).
- Before performing any operation on the appliance, switch off the power supply.
- Disconnect the appliance after the installation, through an accessible plug or switch in case of fixed connection.
- Fit the power line with an all-pole circuit breaker with a contact separation distance sufficient to provide complete disconnection in category III overvoltage conditions, pursuant to installation regulations.
- This appliance can be used up to a maximum altitude of 2,000 metres above sea level.

### **For this appliance**

- Do not rest any weight or sit on the open door of the appliance.
- Take care that no objects are stuck in the doors.
- Do not install/use the appliance outdoors.
- (on some models only) Only use the temperature probe provided or recommended by the manufacturer.

### **Appliance purpose**

This appliance is intended for cooking food in the home environment. Every other use is considered inappropriate. It cannot be used:

- in employee kitchens, shops, offices and other working environments.
- in farms/farmhouses.

- by guests in hotels, motels and residential environments.
- In bed and breakfast accommodation.

### This user manual

- This user manual is an integral part of the appliance and must therefore be kept in its entirety and within the user's reach for the whole working life of the appliance.
- Read this user manual carefully before using the appliance.
- The explanations in this manual include images, which describe all that regularly appears on the display. However, it should be kept in mind that the appliance may be equipped with an updated version of the system, and as such, all that appears on the display may differ from those in the manual.

### Manufacturer's liability

The manufacturer declines all liability for damage to persons or property caused by:

- use of the appliance other than that specified;
- failure to comply with the instructions in the user manual;
- tampering with any part of the appliance;
- use of non-original spare parts.

### Identification plate

The identification plate bears the technical data, serial number and brand name of the appliance. Do not remove the identification plate for any reason.

### Disposal



This appliance conforms to the WEEE European directive (2012/19/EU) and must be disposed of separately from other waste at the end of its service life.

The appliance does not contain substances in quantities sufficient to be considered hazardous to health and the environment, in accordance with current European directives.



**Power voltage**  
**Danger of electrocution**

- Disconnect the mains power supply.
- Unplug the appliance.

To dispose of the appliance:

- Cut the power cable and remove it.
- Deliver the appliance to the appropriate recycling centre for electrical and electronic equipment waste, or return it to the retailer when purchasing an equivalent product, on a one for one basis.

Our appliances are packaged in non-polluting and recyclable materials.

- Deliver the packing materials to the appropriate recycling centre.



**Plastic packaging**  
**Danger of suffocation**

- Do not leave the packaging or any part of it unattended.
- Do not let children play with the plastic bags.

### To save energy

- Only preheat the appliance if the recipe requires you to do so.
- When using any of the functions, avoid opening the door during cooking.
- Unless otherwise indicated on the package, defrost frozen foods before placing them in the oven.
- When cooking several types of food it is recommended to cook the foods one after the other to make the best use of the already hot oven.
- Use dark metal moulds: They help to absorb the heat better.
- Remove all trays and racks which are not required during cooking.
- Stop cooking a few minutes before the time normally used. Cooking will continue for the remaining minutes with the heat which has accumulated inside the oven.
- Reduce any opening of the door to a minimum to avoid heat dispersal.
- Keep the inside of the oven clean at all times.

### Light sources

- This appliance contains light sources which cannot be replaced by the user and must only be replaced by the technical assistance

service.

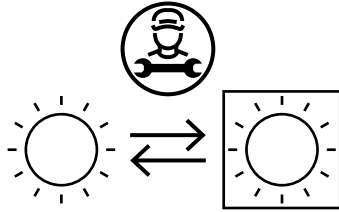

- The light sources contained in the appliance are declared suitable for operation at ambient temperature  $\geq 300^{\circ}\text{C}$  and intended for use in high temperature applications such

as ovens.

- This appliance contains light sources of efficiency class "G".

## How to read the user manual

This user manual uses the following reading conventions:



Warning/ Caution



Information/ Advice

# DESCRIPTION

## General Description

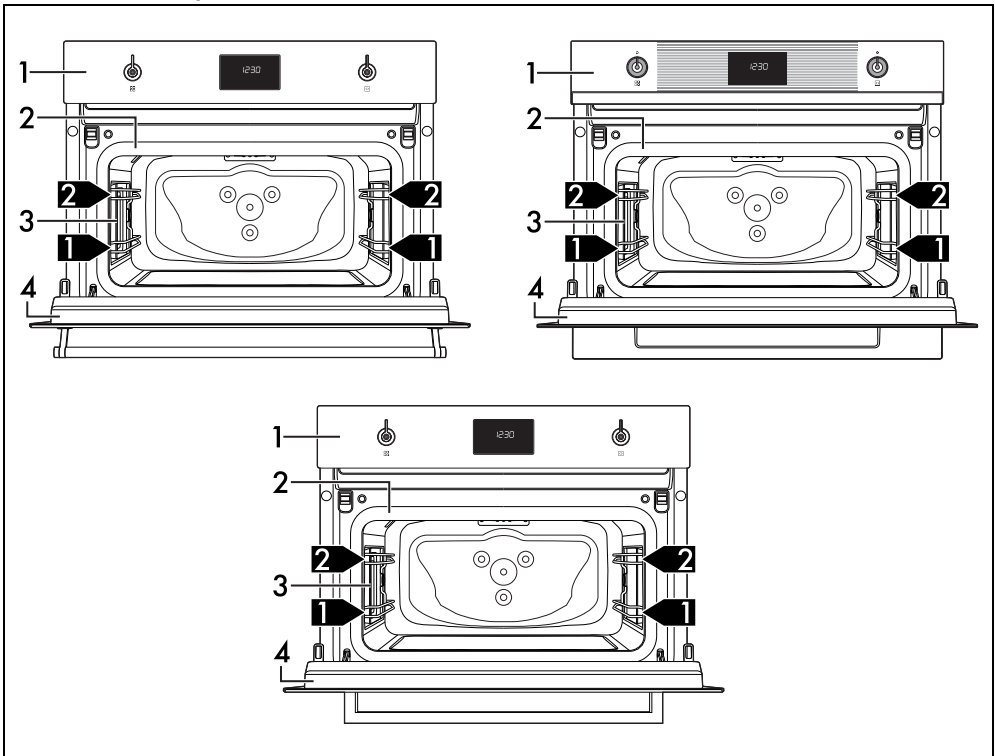

1 Control panel

2 Seal

3 Light bulb

4 Door

**1,2,3...** Frame shelf

# Control panel

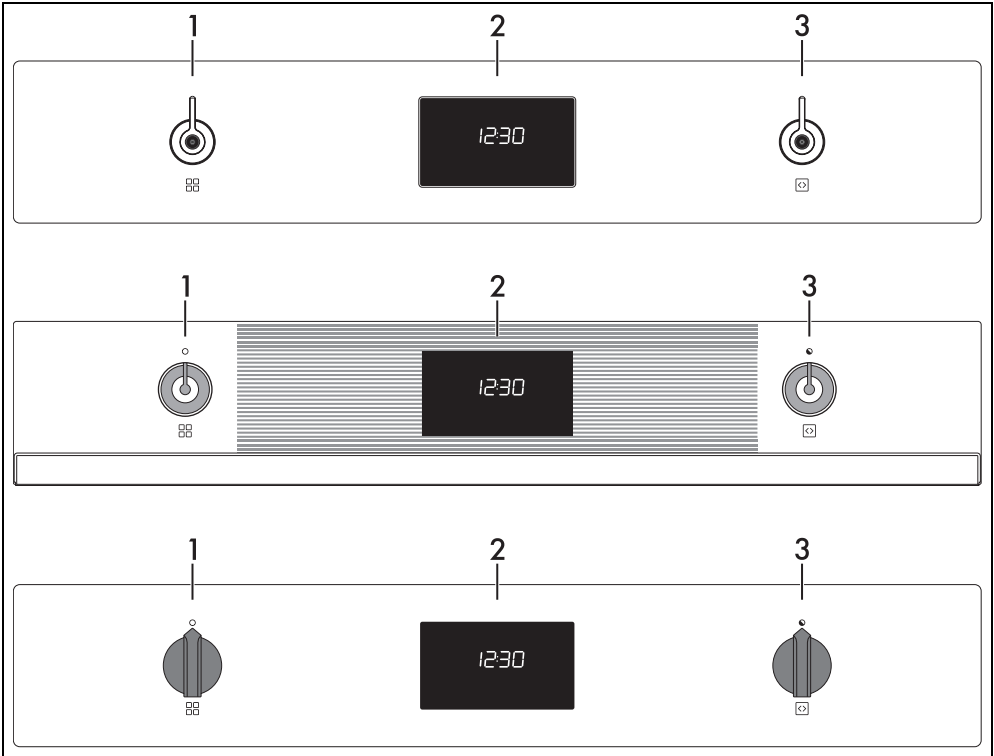

## 1 Function knob

This knob can be used to:

- turn the appliance on and off;
- select a function.

 Turn the Function knob to the position 0 to immediately complete any cooking operation.

## 2 Digital programmer

Displays the current time, the minute minder, the function, the microwave power, the selected cooking temperature, power and any time set.

## 3 Temperature knob

This knob can be used to set:

- the cooking temperature;
- the duration of a function;
- programmed cooking cycles;
- the current time.

## Other parts

### Shelves

The appliance features shelves to position trays

and racks at different heights. The insertion heights are indicated from the bottom upwards.

## Cooling fan

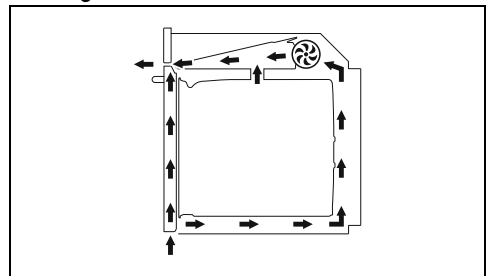

The fan cools the appliance and comes into operation during cooking.

The fan causes a steady outflow of air from above the door which may continue for a short period of time even after the appliance has been turned off.

## Oven cavity lighting

- The lighting of the oven cavity is activated when any cooking function is selected.
- When the door is opened the lighting in the

oven cavity is switched on. It switches off immediately when the door is closed.

- When the door is open, it is not possible to turn off the interior lighting.

## Accessories

- Not all accessories are available on some models.
- The accessories intended to come into contact with food are made of materials that comply with the provisions of current legislation.
- Original supplied and optional accessories can be requested to Authorised Assistance Centres. Use only original accessories supplied by the manufacturer.
- It is recommended to mount the pull-out slides on the first shelf of the frames. In this way, it is possible to optimise the space inside the oven cavity with an intermediate level between the first and the second shelf.



In this manual, suggestions for the second or middle shelf refer to the use of pull-out slides.

## Lowered pan stand

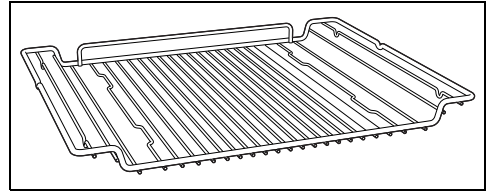

Used for supporting containers with food during cooking.

## Optional accessories (can be purchased separately)

### Chef plate

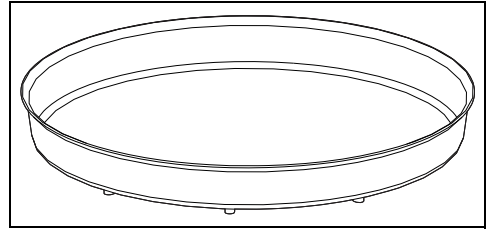

Good for browning foods evenly.

## Microwaves

The appliance is equipped with a microwave generator called a magnetron. The microwaves generated are evenly emitted into the oven cavity in order to reach the food and heat it.

Heating takes place through friction between the molecules contained in the food (mainly water molecules), with the consequent generation of heat.

The heat generated directly inside the food allows it to be defrosted, re-heated or cooked in a shorter time compared to traditional cooking.

The use of suitable containers for microwave cooking leads to the microwaves reaching the food in a uniform manner.

## Boiling rod

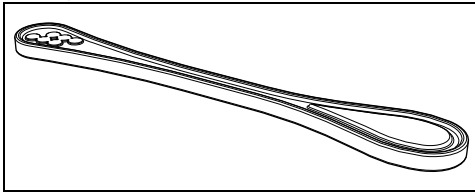

To be placed in containers when heating liquids, necessary to avoid delayed boiling.

# USE

## Preliminary operations



See General safety instructions.

- Remove any protective film from the outside or inside of the appliance, including accessories.
- Remove any labels (apart from the technical

data plate) from the accessories and shelves.

- Remove and wash all the appliance accessories (see chapter "CLEANING AND MAINTENANCE").

## First heating

1. Set a cooking time of at least one hour (see paragraph "Using the oven").

- Heat the empty oven compartment at the maximum temperature to burn off any residues left by the manufacturing process.

When heating the appliance

- air the room;
- don't stay.

## Materials suitable for use with microwaves

In general, in order for all of the food to be reached, the materials used for microwave cooking must be transparent to microwave energy.

Below is a table of materials to use and those not to use:

### MATERIALS TO USE:

- Glass (always remove the lids)\*

- Baking ware
- Glasses
- Jars

- Porcelain

- Earthenware

- Plastic (only where suitable for microwave use)\*

- Containers
- Plastic wrap (must not come into contact with the food)

\*only if heat-resistant.

### MATERIALS NOT TO USE

- Metals (can lead to arcing or sparks)

- Aluminium foil
- Aluminium trays
- Plates
- Metal utensils
- Freezer bags tie wraps

- Wood

- Crystal glasses

- Paper (risk of fire)

- Polystyrene containers (danger of contamination of foodstuffs)



Dishes must be free of metal decorations.



Do not use metal accessory trays in the microwave or combined microwave functions.

## Testing dishes



The microwave function can be used without any food inside the oven only for this test.

To check whether the cookware is suitable for use with microwave cooking, carry out this simple test:

- Remove all accessories from the oven cavity.
- Place the cookware to be tested on the rack inserted in the first shelf.
- Select the microwave function at maximum power level (e.g. 1000 W).
- Set a cooking time of 30 seconds.
- Start cooking.



**Unsuitable cookware**  
**Risk of damage to the appliance**

- Stop the test immediately if there is a cracking sound or if sparks are emitted from the cookware. If this happens, it means that the cookware is not suitable for microwave cooking.

At the end of the test the cookware must be either cold or slightly warm. If the cookware is hot then it should be considered as unsuitable for microwave use.

## Using the accessories

### Racks and trays

Racks and trays have to be inserted into the side guides until they come to a complete stop.

- The mechanical safety locks that prevent the rack from being removed accidentally must face downwards and towards the back of the oven cavity.

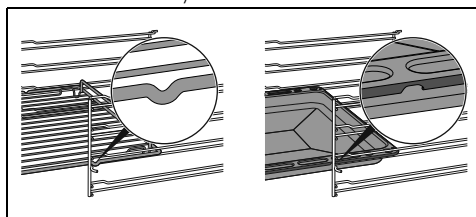

Gently insert racks and trays into the oven until they come to a stop.



Clean the trays before using them for the first time to remove any residues left by the manufacturing process.

## Boiling rod

**! Improper use**  
**Danger of explosion/burns**

- To avoid the danger of explosion inside the appliance or the sudden boiling over of superheated liquids, always place a boiling rod in the liquid that is being heated.

**! High temperature**  
**Risk of damage to the accessory**

- Use the boiling rod only with Microwave functions. The rod must not be used with combination and traditional functions.

When using the microwave to heat or reheat liquids, the boiling process may be delayed. To avoid this, place the boiling rod (or a heat-resistant plastic spoon) supplied into the container while heating.



## Chef plate

**! Improper use**  
**Danger of explosion/burns**

- This accessory gets very hot. Always use oven gloves when handling.

**! High temperature**  
**Risk of damage to the accessory**

- Do not use knives directly on the surface of the plate
- When cleaning, do not use metal sponges or scourers which could damage the surface.

The Chef plate must be placed in the centre of

the rack for perfect operation.

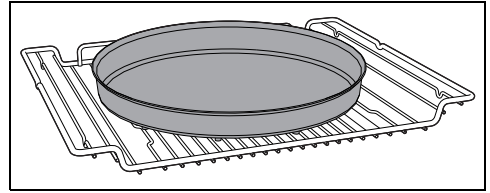

## Digital programmer

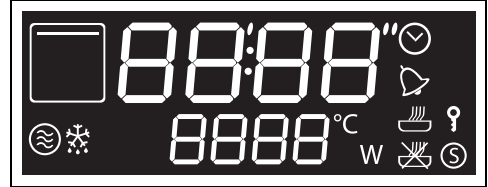

The parameters and values for the currently selected function will be indicated on the display. To use it, just turn the function and temperature knobs to select the indicated values.

- Clock indicator light
- Minute minder indicator light
- Cooking indicator light
- Programmed cooking indicator light
- Control lock indicator light
- Showroom indicator light
- Microwave indicator light
- Defrost indicator light
- Temperature indicator light
- Watt indicator light

### First use

- If the time is not set, the oven will not switch on.

When using the appliance for the first time or after a prolonged power failure, **00:00** will flash on the display. In order to start a cooking function, the current time has to be set.

1. Turn the temperature knob to select the current time.
2. Press the temperature knob to set the hours and then move to the minutes.
3. Turn the temperature knob to select the minutes.

- Press the temperature knob to finish adjustment.

 It may be necessary to change the current time, for example for daylight saving time.

 When the current time is shown, the display will be dimmed 2 minutes after the knobs were last used.

## Using the oven

 See General safety instructions.

### Microwaves

 Given that they penetrate directly into the food, microwaves allow cooking to take place in a very short period of time and with a considerable saving of energy. They are suitable for cooking without fat and also for defrosting and re-heating food while maintaining its original appearance and fragrance.

 When using the microwave, the food (or its container) must not be placed on the bottom of the oven cavity. Use the supplied accessories inserted in the shelves suitable for the recipe you want to make.

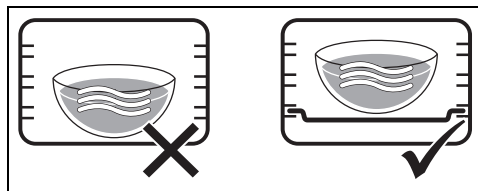

 DO NOT USE CONTAINERS/ACCESSORIES (trays, glass dishes, etc.) RESTING DIRECTLY ON THE BOTTOM OF THE OVEN CAVITY.

- Open the door.
- Place the dish into the oven cavity.
- Close the door.

- From position 0, turn the function knob to the left by one position to select the MICROWAVE function .

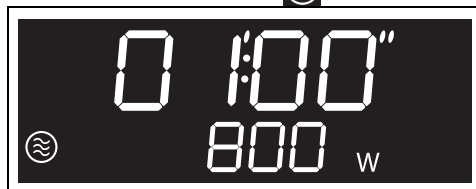

- Turn the temperature knob to set the cooking time (from 5 seconds to 1 hour and a half) (e.g. "5 minutes").



fig. 1

- Press the temperature knob to confirm.
- While the Watt indicator light **W** flashes, turn the temperature knob to change the power value from 100 W to 800 W (for example "500 watt").



For a reference on microwave power, see the paragraph Microwave power.

- Wait 3 seconds to start the cooking or press the temperature knob to enter any setting of cooking duration, cooking end...

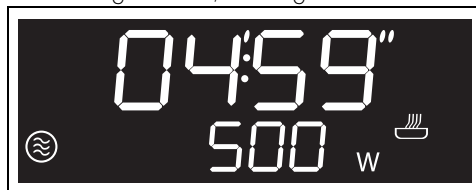

- Check the cooking status of the food by turning on the internal light.

 When the door is opened, the function in progress is interrupted. Once the door is closed press the temperature knob to resume cooking.



Cooking functions can be interrupted at any time by turning the function knob to the 0 position.

At the end of the cooking time **STOP** flashes on the display and a buzzer will sound that can be deactivated by opening the door and/or pressing/turning any of the two knobs.



### Microwave power levels

Below is a list of the power levels that can be selected:

Power (W)	Uses
100	
200	Thawing food
300	
400	Delicate cooking
500	
600	Re-heating and cooking food
700	
800	Heating liquids

### Microwave + Grill





The use of the grill results in perfect browning of the food's surface. Using the microwave on the other hand leads to rapid internal cooking of the food.



#### Improper use Risk of damage to the appliance

- Do not use the combination functions to heat or boil liquids.

- Turn the function knob to the right or left to select the "MICROWAVE + GRILL"  +  function.



- Turn the temperature knob to the right or to the left to select the wished temperature (for example "200°C").



- Press the temperature knob to confirm.
- While the clock indicator light  flashes, turn the temperature knob to the right or to the left to change the cooking duration (from 1 minute to 13 hours) (for example "15 minutes").



- Press the temperature knob to confirm.
- While the Watt indicator light  flashes, turn the temperature knob to the right or to

the left to change the power value from 100 W to 600 W (for example "400 watt").



7. Press the temperature knob to confirm the data entered.
8. Press the temperature knob to start combination cooking.



 When the door is opened, the function in progress is interrupted. Once the door is closed, press the temperature knob to resume cooking.

### Preheating stage

Cooking itself is preceded by a preheating stage, which allows the appliance to heat to the cooking temperature more quickly.

The cooking indicator light  flashes to indicate that this stage is in progress.

When the preheating stage is over, the cooking indicator light  will remain lit steadily and a buzzer will sound to indicate that the food can be placed inside the oven.

### End of Microwave + Grill cooking

At the end of the cooking time **STOP** flashes on the display and a buzzer will sound that can be deactivated by opening the door and/or pressing/turning any of the two knobs.



### Grill

 It allows to obtain excellent grilling and grating results. Used at the end of cooking, it gives a uniform browning to the dishes.

1. Turn the Function knob to the right or left to select the GRILL function .
2. Turn the temperature knob to the right or to the left to select the wished temperature (for example "200°C").

Wait 3 seconds to start cooking or press the temperature knob to enter any setting of cooking duration, cooking end time...





 When the door is opened, the function in progress is interrupted. The function resumes automatically when the door is closed.

### Preheating stage

Cooking itself is preceded by a preheating stage, which allows the appliance to heat to the cooking temperature more quickly.

The indicator light  flashes to indicate that this stage is in progress.

 You can skip the preheating phase by pressing the temperature knob for a few seconds.

At the end of preheating the indicator light  will stay on permanently, the symbol of the oven cavity  flashes and a buzzer sounds.

1. Open the door
2. Place the dish with the food to be cooked into the oven cavity.
3. Close the door.

or

If the dish with the food is already inside the oven cavity, press the temperature knob to start cooking.

## Timed cooking



Timed cooking is the function which allows a cooking operation to be started and then ended after a specific length of time set by the user.



Activation of timed cooking cancels any minute minder timer which may previously have been set.

1. After selecting a cooking function and temperature, press the temperature knob.

The display shows **00:00** flashing.



2. Within 3 seconds turn the temperature knob to change the temperature  
or
3. Press the temperature knob to set the cooking time (from 1 minute to 13 hours) (e.g. "25 minutes").



4. Wait 3 seconds.

The indicator light  stops flashing, the symbol  lights up and timed cooking begins.

At the end of the cooking time **STOP** flashes on the display and a buzzer will sound that can be deactivated by opening the door and/or pressing/turning any of the two knobs.



To select a further timed cooking, turn again the temperature knob.

## To delete a timed cooking

1. Press the temperature knob.

The indicator light  flashes on the display.

2. Within 3 seconds, turn the temperature knob counter-clockwise until the cooking time is reset.
3. Wait 3 seconds or press the temperature knob to exit the timed cooking function and return to the current time display.

## Programmed cooking



Programmed cooking is the function which allows a cooking operation to be started at a set time and then ended after a specific length of time set by the user.



For safety reasons, it is not possible to set the end of cooking time by itself without setting the cooking duration.

1. After selecting a cooking function and temperature, press the temperature knob.

The display shows **00:00** flashing.



2. Within 3 seconds turn the temperature knob to set the cooking time (from 1 minute to 13 hours) (e.g. "25 minutes").



3. Press the temperature knob.

The display shows the suggested flashing time for immediate cooking.



In case of confirmation without modification, cooking starts immediately. If time is added to the suggested time, cooking stops

- Turn the temperature knob within 3 seconds to set the end of cooking time (e.g. "13:15").



- Wait 3 seconds.

The indicator light  and the appliance waits for the set start time.



 The minutes required for preheating are already included in the end-of-cooking time.

At the end of the cooking time **STOP** flashes on the display and a buzzer will sound that can be deactivated by opening the door and/or pressing/turning any of the two knobs.

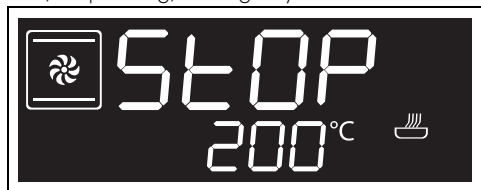

### To delete a programmed cooking

- Press the temperature knob.

The indicator light  flashes on the display.

- Within 3 seconds, turn the temperature knob clockwise or counter-clockwise to set a new timed cooking.

The set cooking has now been deleted.

 Cooking functions can be interrupted at any time by turning the function knob to the 0 position.

### Minute minder timer during a cooking process

 The minute minder timer does not stop the cooking operation but rather informs the user when the set time has run out.

 It is not possible to set a minute minder during a cooking if a timed cooking has already been set.

- After selecting a cooking function and temperature, press the temperature knob two times.

The display shows **00:00** and the indicator light  flashes.



 You can also set a minute minder timer also when cooking is in progress.

- Within 3 seconds turn the temperature knob to set the duration of the minute minder (from 1 minute to 13 hours).
- Wait 3 seconds.

The indicator light  stops flashing and the minute minder starts.

- Wait for the buzzer to indicate that the time has finished.

The digits **00:00** and the indicator light  flash.

- Turn the temperature knob to select additional minute minders or press the temperature knob to deactivate the buzzer and exit the minute minder during cooking.

After a few seconds, the display shows the current time and the cooking in progress continues.

### To delete a minute minder timer during cooking

- During cooking, press the temperature knob twice.

The indicator light  flashes on the display.

- Within 3 seconds, turn the temperature knob counter-clockwise until the minute minder value is reset.

3. Wait 3 seconds to exit the minute minder function during cooking.

## Cooking advice

### General advice

- It is not possible to shorten cooking times by increasing the temperature (the food could be overcooked on the outside and undercooked on the inside).

### Advice for cooking meat

- Cooking times vary according to the thickness and quality of the food and to consumer taste.
- Turn the food to brown both sides.
- Use a meat thermometer when roasting meat, or simply press on the roast with a spoon. If it is hard, it is ready; If not, it needs another few minutes cooking.

### Advice for cooking with the Grill

- Meat can be grilled even when it is put into the cold oven or into the preheated oven if you wish to change the effect of the cooking.
- We recommend placing the food at the centre of the rack.
- With the Grill function, we recommend that you set the temperature to the maximum value to optimise cooking.

### Advice for cooking desserts/pastries and biscuits

- Use dark metal moulds: They help to absorb the heat better.
- The temperature and the cooking time depend on the quality and consistency of the dough.
- To check whether the dessert is cooked right through: At the end of the cooking time, put a toothpick into the highest point of the dessert. If the dough does not stick to the toothpick, the dessert is cooked.
- If the dessert collapses when it comes out of the oven, on the next occasion reduce the set temperature by about 10°C, selecting a longer cooking time if necessary.

### Advice for defrosting and proving

- Place frozen foods without their packaging in a lidless container on the first shelf of the oven.
- Avoid overlapping the food.
- To defrost meat, use the rack placed on the second level and a tray on the first level. In

this way, the liquid from the defrosting food drains away from the food.

- The most delicate parts can be covered with aluminium foil.
- For successful proving, a container of water should be placed in the bottom of the oven.

### To save energy

- Stop cooking a few minutes before the time normally used. Cooking will continue for the remaining minutes with the heat which has accumulated inside the oven.
- Reduce any opening of the door to a minimum to avoid heat dispersal.
- Keep the inside of the appliance clean at all times.

## Discover the recipes

To consult the recipes developed for various categories of food and to get more information on cooking suggestions, we recommend visiting the dedicated page on the [www.smeg.com](http://www.smeg.com) website, which can be reached using the QR code on the leaflet supplied with the product.

### Minute minder



This function only operates the buzzer at the end of the countdown.

1. With the Function Knob at position 0, press the temperature knob.

The display shows **00:00** and the indicator light  flashes.

2. Within 3 seconds turn the temperature knob to set the duration of the minute minder (from 1 minute to 13 hours).
3. Wait 3 seconds.

The indicator light  stops flashing and the minute minder starts.



During the function, the display shifts to low brightness after 2 minutes from the last knob operation.

### End of the minute minder

1. Wait for the buzzer to indicate that the time has finished.

The digits **00:00** and the indicator light  flash.

2. Turn the temperature knob to select another minute minder.

or

- Press the temperature knob to deactivate the buzzer and exit the minute minder function.

After a few seconds, the display shows the current time.

### To delete a minute minder

- Press the temperature knob.

The indicator light  flashes on the display.



- Within 3 seconds, turn the temperature knob counter-clockwise until the minute minder value is reset.
- Wait 3 seconds to exit the minute minder function.

### Defrosting

 This function allows you to defrost food on the basis of a selectable time.

- Place the dish into the oven cavity.
- Turn the Function knob until the Defrosting function screen is displayed.
- Press the temperature knob to confirm the DEFROSTING function .



The display shows the digits  and the microwave  and defrosting  indicator lights flash.

- Turn the temperature knob to set the defrosting time (from 5 seconds to 99 minutes) (for example "12 minutes and 30 seconds").



- Wait 3 seconds or press the temperature knob to start defrosting.



When the door is opened, the function in progress is interrupted. Once the door is closed, press the temperature knob to resume cooking.

### End of defrosting

At the end of defrosting, the flashing wording **STOP** is displayed and a buzzer will sound that can be deactivated by opening the door and/or pressing/turning any of the two knobs.



- Turn the function knob to position 0 to exit the function.

### Defrosting table

Type	Weight (g)	Time (min)
Minced meat	500	25
Whole chicken	1100	40
Whole fish	500	20
Cakes	500	5

### "Turn" procedure

For best defrosting results it is recommended, when necessary, to turn the dish inside the oven cavity.

- Put the dish in the oven, placing it parallel to the door.

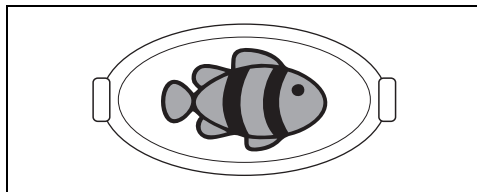

- When **turn** is displayed it is necessary to turn the dish.



3. Open the door and turn the dish by 180°.

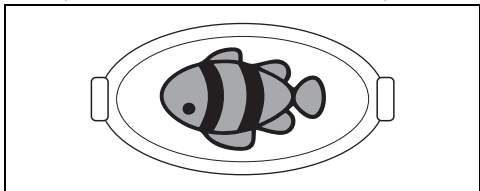

If dish rotation is not performed the appliance will wait for one minute and then automatically continue defrosting. As a reminder the word **turn** will remain displayed beneath the countdown indication.



4. Close the door and press the function knob to resume operation.
5. If necessary the appliance will again ask for rotation of the dish. **turn** will be shown on the display.
6. For the second rotation the door will need to be opened and the dish turned by 90°.

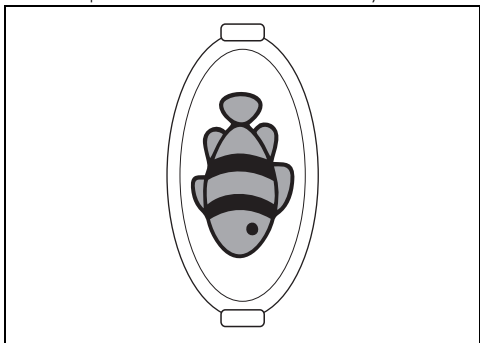

7. Close the door and press the function knob to resume operation.

### Chef function

**CHEF** This function provides food with a golden, crunchy texture by using the Chef plate. Ideal for pizzas, oven chips and pies.

1. Position the rack on the required level. In the middle, place the empty Chef plate (to be purchased separately).

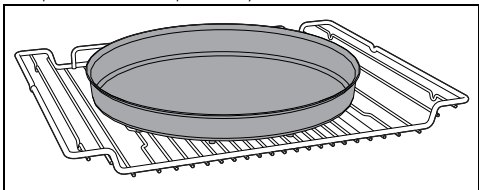

2. Turn the function knob until the Chef function screen is displayed.



3. Press the temperature knob to confirm the Chef function.

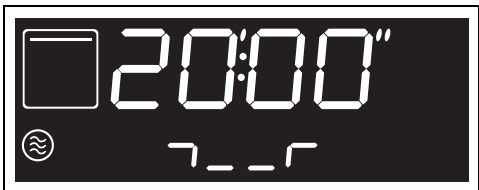

4. Turn the temperature knob to set the Chef function time (from 10 seconds to 99 minutes) (for example "14 minutes").



The parameters for microwave power and cooking temperature cannot be changed by the user.

- Press the temperature knob to confirm the parameters and start preheating the empty Chef plate.



- When preheating has finished, the appliance will wait for food to be inserted in the Chef plate.

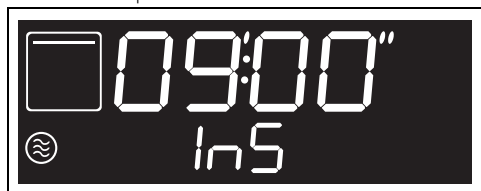

**Improper use**  
**Danger of burns**

- Use oven gloves when handling the Chef plate.

- Position the food inside the Chef plate.

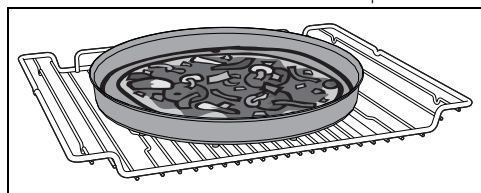

**Improper use**  
**Risk of damage to the appliance**

- Do not position recipients on the Chef plate if they are not heat proof.

- Press the temperature knob to restart cooking.

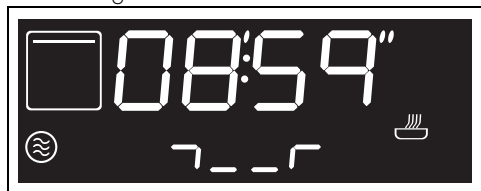

End of the Chef function

- At the end of the cooking time **STOP** flashes on the display and a buzzer will sound that can be deactivated by opening

the door and/or pressing/turning any of the two knobs.



**Cooking suggestions table**

Type	Weight (g)	Time (min)
Frozen pizza	400	10
Frozen oven chips	500	15
Frozen chicken nuggets	500	15
Fresh beaten eggs	400	12

 The indicated time includes the time for preheating the empty Chef plate (5 minutes).

**Settings**

- Turn the function knob until the following text appears on the display.



- Press the temperature knob to access the settings menu.

**Current time**

After entering the settings menu, turn the temperature knob until the current time function is selected.



- Press temperature knob to start adjusting the current time (e.g. "12:30").

During this procedure, the indicator light 

and the symbols  flash.



2. Turn the temperature knob to select the current time.



3. Press the temperature knob to set the current time and go to the selection of minutes.



4. Turn the temperature knob to select the minutes of the current time.



5. Press the temperature knob to finish adjustment.



6. Turn the temperature knob to select a new setting or wait 10 seconds.

## Control lock (children safety)



This mode allows the appliance to lock the controls automatically after one minute of normal operation without any intervention from the user.

1. After entering the settings menu, turn the temperature knob until the control lock function is selected.



2. Press the temperature knob to confirm.

The indicator light  flashes.

3. Within 10 seconds turn the temperature knob to activate the control lock function.



4. Press the temperature knob to confirm.

5. Turn the display knob to select a new setting.



In normal operation, the control lock is indicated by the  indicator light coming on.



Touching or varying the position of the knobs, the display will show the wording **bLOC** for two seconds.



To release the lock temporarily during cooking, hold the temperature knob down for 5 seconds. One minute after the last setting the lock will become active again.

## Showroom (for showrooms only)



This mode allows the appliance to deactivate all heating elements, while keeping the control panel active.

1. After entering the settings menu, turn the temperature knob until the showroom function is selected.



2. Press the temperature knob to confirm.

3. Turn the temperature knob to activate the showroom function.



4. Press the temperature knob to confirm or wait 10 seconds.



The activated showroom is indicated on the display by the **S** indicator light on.



To use the appliance normally, set this function to OFF.

# CLEANING AND MAINTENANCE

## Cleaning the appliance



See General safety instructions.

### Cleaning the surfaces

To keep the surfaces in good condition, they should be cleaned regularly after use. Let them cool first.

### Ordinary daily cleaning

Always and only use specific products that do not contain abrasives or chlorine-based acids. Pour the product onto a damp cloth and wipe the surface, rinse thoroughly and dry with a soft cloth or a microfibre cloth.

### Food stains or residues

Do not use steel sponges and sharp scrapers as they will damage the surface.

Use normal, non-abrasive products and a wooden or plastic tool, if necessary. Rinse thoroughly and dry with a soft cloth or a microfibre cloth.

Do not allow residues of sugary foods (such as jam) to set inside the oven. If left to set for too long, they might damage the enamel lining of the oven.

## Cleaning the door

### Door disassembly

For easier cleaning it is recommended to remove the door and place it on a tea towel.

To remove the door proceed as follows:

1. Open the door completely and insert two pins into the holes on the hinges indicated in the figure.

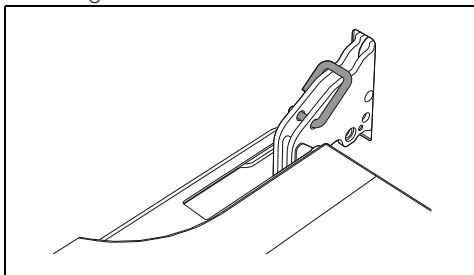

2. Grasp the door on both sides with both hands, lift it forming an angle of around 30° and remove it.

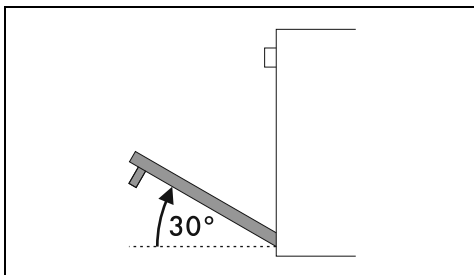

3. To reassemble the door, put the hinges in the relevant slots in the oven, making sure

that grooved sections **A** are resting completely in the slots.

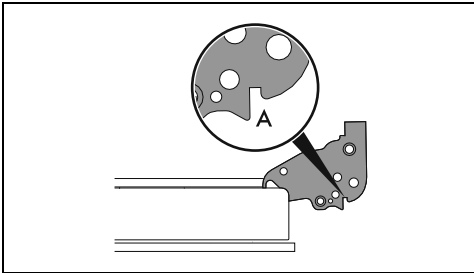

4. Lower the door and once it is in place remove the pins from the holes in the hinges.

### Cleaning the door glazing

The glass in the door should always be kept thoroughly clean. Use absorbent kitchen roll. In case of stubborn dirt, wash with a damp sponge and an ordinary detergent.

### Cleaning the oven cavity

In order to keep your oven in the best possible condition, clean it regularly after letting it cool down.

Avoid letting food residue dry inside the oven cavity, as this could damage the enamel.

Take out all removable parts before cleaning. For easier cleaning, it is recommended to remove:

- the door;
- The rack/tray support frames.



In the event you are using specific cleaning products, we recommend running the oven at maximum temperature for 15-20 minutes in order to eliminate any residue.

### Drying

Cooking food generates moisture inside the appliance. This is a normal phenomenon and does not affect the appliance's operation in any way.

Each time you finish cooking:

1. Let the appliance cool down.
2. Remove any dirt from inside the appliance.
3. Dry the interior of the appliance with a soft cloth.
4. Leave the door open until the inside of the appliance has dried completely.

### Removing rack/tray support frames

Removing the rack/tray support frames enables

the sides to be cleaned more easily.

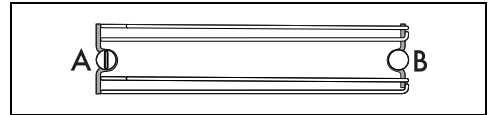

A = front housing

B = rear pin



In some models, the rear pin B can be removed and re-assembled in the same way as the front housing A.



To remove the rack/tray support frames:

1. Unscrew the front fixing pin located on the side wall near the opening of the oven cavity (you can help yourself with a tool, e.g. a coin).

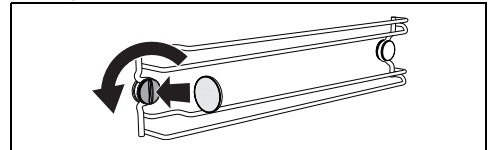

2. Carefully pull the frame towards the inside of the oven cavity to unhook it from front housing A.

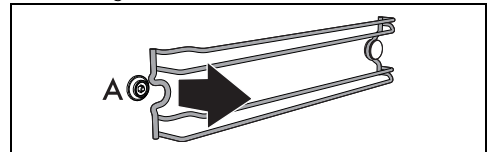

3. Remove the frame from the rear pin B located at the bottom of the side wall.

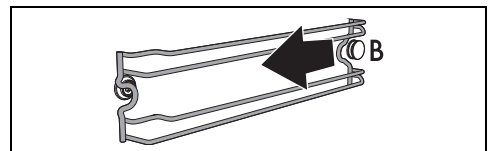

4. Repeat the operation for the frame placed on the other side wall.

To refit the rack/tray support frames:

- Slide the rear part of the frame into the housing under the pin B located at the bottom of the side wall.

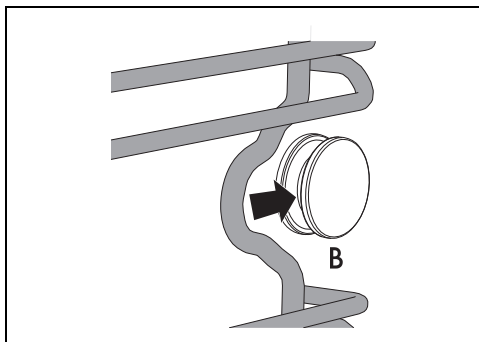

- Replace the front part of the frame in housing A on the side wall near the opening of the oven cavity.

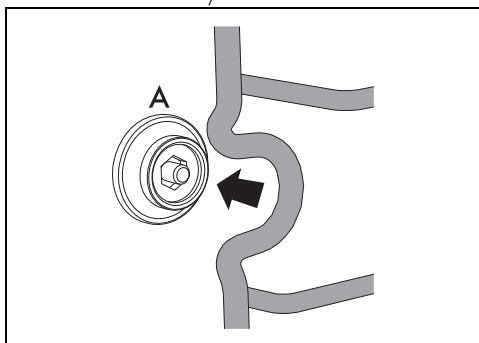

- Screw in the front fixing pin (you can help yourself with a tool, e.g. a coin).

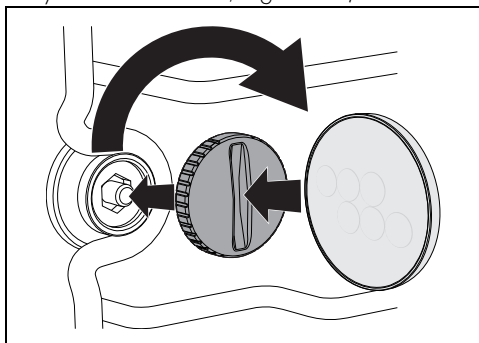

- Repeat the operation for the frame placed on the other side wall.

### Vapor Clean End

- Turn the function knob to 0 to exit from the function.
- Open the door and wipe away the less stubborn dirt with a microfibre cloth.
- Use a non-scratch sponge with brass filaments on hard to remove deposits.
- In case of grease residues use specific oven cleaning products.
- Remove the residual water inside the oven.
- Replace the self-cleaning panels and the rack/tray support frames, if fitted.

For greater hygiene and to avoid foods taking on unpleasant odours:

- We recommend drying the inside of the oven with a fan assisted function at 160°C for around 10 minutes.
- If self-cleaning panels are fitted, we recommend that you dry the inside of the oven with a simultaneous catalytic cycle.



We recommend wearing rubber gloves for these operations.



We recommend removing the door in order to make the manual cleaning of the parts that are difficult to reach easier.

### Extraordinary maintenance

#### Seal maintenance tips

The seal should be soft and elastic.

- To keep the seal clean, use a non-abrasive sponge and wash with lukewarm water.

## INSTALLATION

### Electrical connection



See General safety instructions.

### General information

Check the mains characteristics against the data indicated on the plate.

The identification plate bearing the technical

data, serial number and brand name is visibly positioned on the appliance.

Do not remove this plate for any reason.

The appliance must be connected to ground using a wire that is at least 20 mm longer than the other wires.

The appliance can work in the following modes:

- 220-240 V~

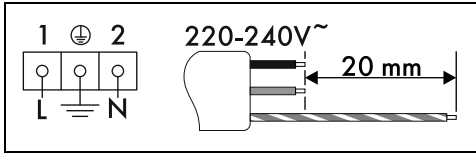

3 x 1.5 mm<sup>2</sup> three-core cable.



The values indicated above refer to the cross section of the internal lead.



The aforementioned power cables are sized taking into account the coincidence factor (in compliance with standard EN 60335-2-6).

### Fixed connection

Fit the power line with an all-pole circuit breaker with a contact separation distance sufficient to provide complete disconnection in category III overvoltage conditions, pursuant to installation regulations.

### For the Australian/New Zealand market:

The circuit breaker incorporated in the fixed connection must comply with AS/NZS 3000.

### Connection with plug and socket

Make sure that the plug and socket are of the same type.

Avoid using adapters, gang sockets or shunts as these could cause overheating and a risk of burns.

### Cable replacement



Power voltage  
Danger of electrocution

- Disconnect the mains power supply.
1. Unscrew the rear casing screws and remove the casing to access the terminal board.

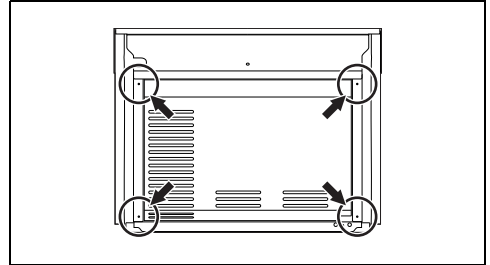

2. Replace the cable.
3. Make sure that the cables (for the oven or any hob) follow the best route in order to avoid any contact with the appliance.

### Positioning



See General safety instructions.

### Position of the power cable

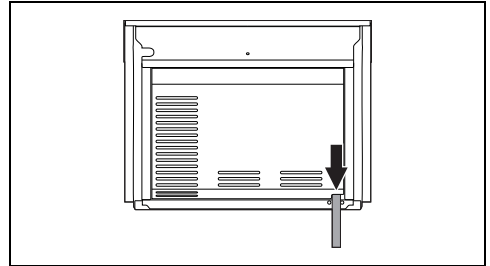

### Front panel seal

Glue the supplied seal to the rear part of the front panel to avoid water or other liquids from leaking in.

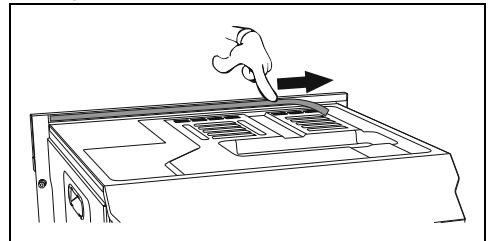

## Fastening bushings

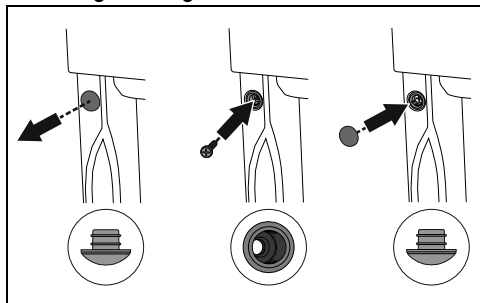

1. Remove the bushing covers on the front of the appliance.
2. Mount the appliance into the recess.
3. Secure the appliance to the cabinet using screws.
4. Cover the bushings with the previously removed covers.

## Appliance overall dimensions (mm)

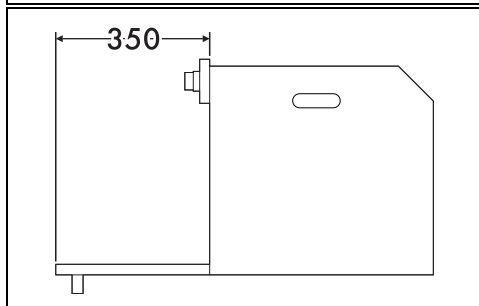
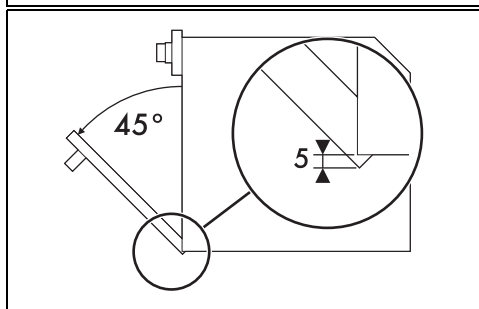
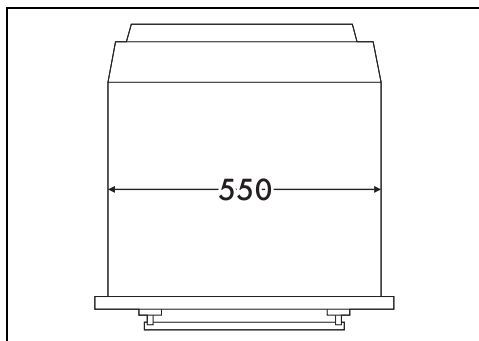
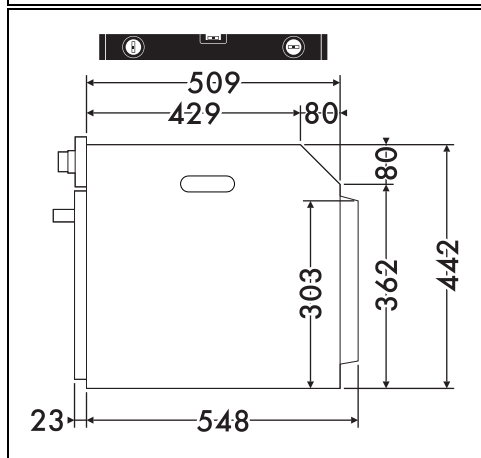
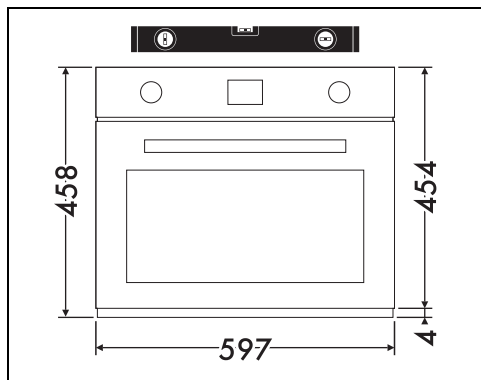

## Mounting into a column (mm)

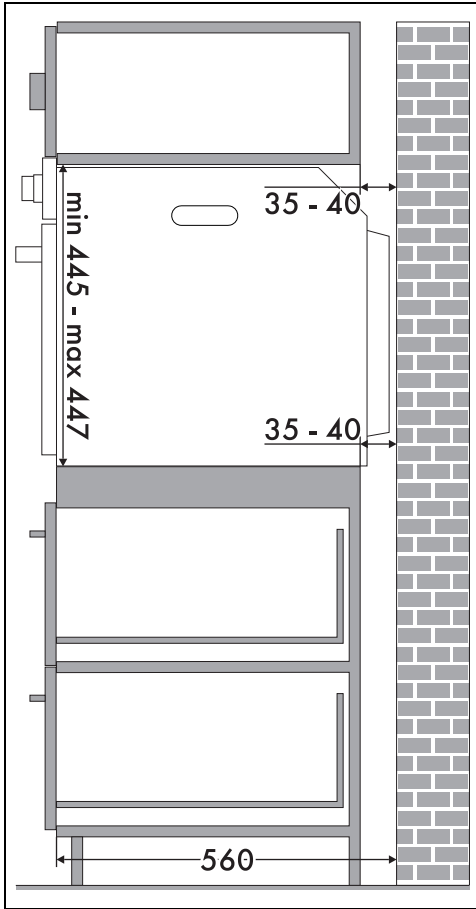

\* Make sure that the cabinet top/rear section has an opening approx. 35-40 mm deep.

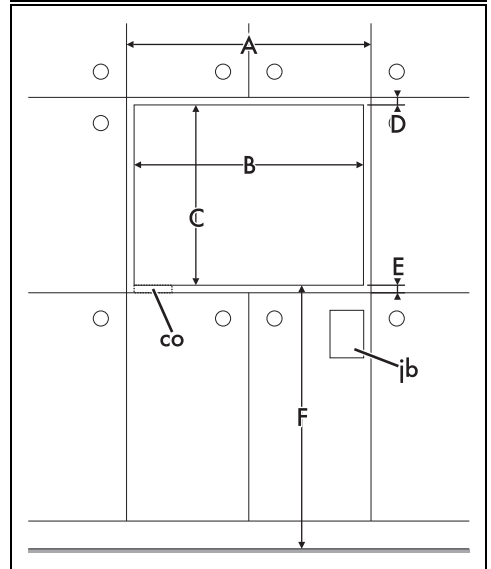
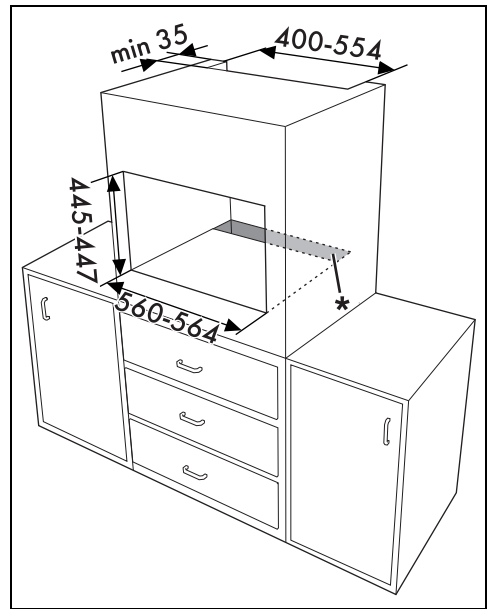

## Mounting under worktops (mm)

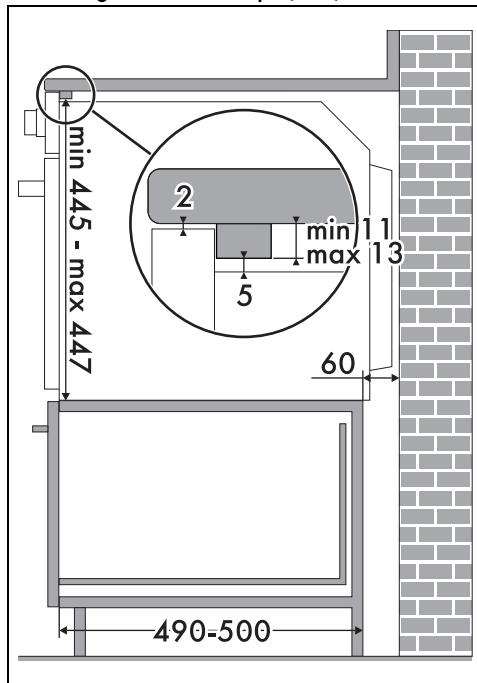
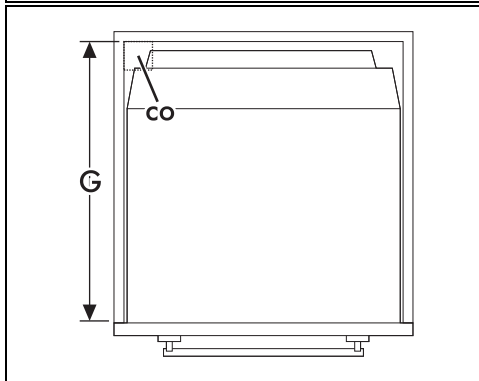
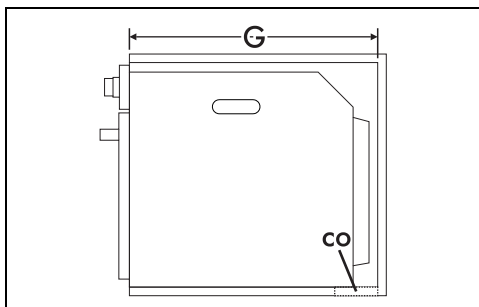

EN

A min. 603 mm

B 560 - 564 cm

C 445 - 447 cm

D 9 - 11 cm

E min. 5 mm

F 259 - 1105 cm

G min. 560 mm

H min. 458 mm

co Cutout for power cord (min. 6 cm<sup>2</sup>)

jB Electrical connection box



If the appliance is to be built-in under a worktop, a wooden bar has to be installed order to use the seal that is glued to the back of the front panel to prevent water or other liquids leaking in.

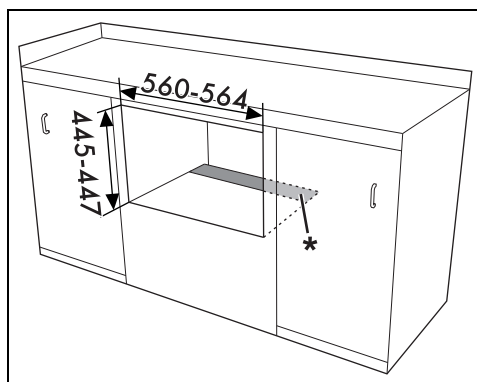

\* Make sure that the piece of furniture top/rear part has an opening approx. 60 mm deep.

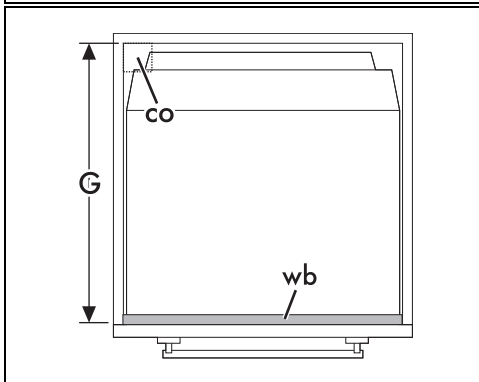
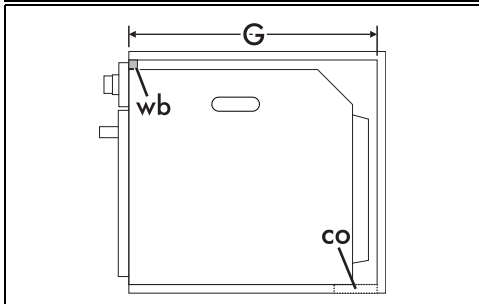
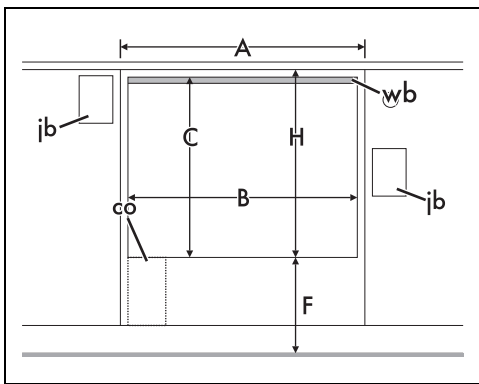

A min. 603 mm

B 560 - 564 mm

C 445 - 447 mm

D 9 - 11 mm

E min. 5 mm

F 259 - 1105 mm

G min. 560 mm

H min. 458 mm

co Cutout for power cord (min. 6 cm<sup>2</sup>)

ib Electrical connection box

wb Wooden bar (recommended)