



AC INFINITY

AIRTITAN SERIES

CRAWLSPACE AND BASEMENT VENTILATION FANS

USER MANUAL



WELCOME

Thank you for choosing AC Infinity. We are committed to product quality and friendly customer service. If you have any questions or suggestions, please don't hesitate to [contact](#) us. Visit www.acinfinity.com and click contact for our contact information.

EMAIL

support@acinfinity.com

WEB

www.acinfinity.com

LOCATION

Los Angeles, CA

MANUAL CODE AT2007X2

PRODUCT

AIRTITAN T3
AIRTITAN T7
AIRTITAN T8
AIRTITAN T8-N

MODEL

AC-ATT3
AC-ATT7
AC-ATT8
AC-ATT8-N

UPC-A

00819137020467
00819137020474
00819137020481
00819137020498

MANUAL INDEX

Manual Index	Page 5
Key Features	Page 6
Product Contents	Page 7
Mounting	Page 8
Powering	Page 10
Programming	Page 12
FAQ	Page 20
Other AC Infinity Products	Page 21
Warranty	Page 22

KEY FEATURES

HEAVY DUTY BUILD

The fan system features a galvanized steel or aluminum mounting frame with fan guards. Fans are enclosed in steel or plastic.

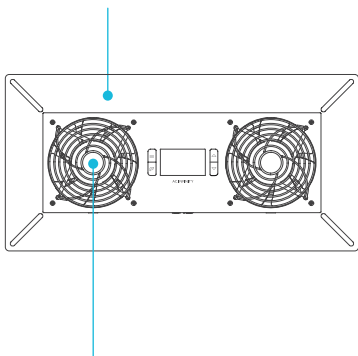

DUAL BALL BEARINGS

Each fan contains long-life ball bearings rated at 67,000 hours. This bearing system enables fans to be mounted in any direction.

QUIET PWM MOTOR

PWM-controlled motor features precise speed control, reduced rotor noise, and runs on energy efficient DC voltage.

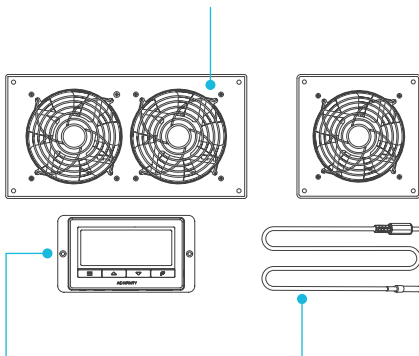

SMART CONTROLLER

Digital controller can be set to trigger fans at high and low temperature and humidity. Features alarms and fan speed control.

INGRESS PROTECTION

Fans are sealed to be dust proof and high water resistance. Can receive water splashes and high pressure water jets.

THERMAL PROBE

The corded precision sensor probe constructed of stainless steel ensures an accurate temperature and humidity reading.

PRODUCT CONTENTS

AIRTITAN T8 AIRTITAN T8-N

AC-ATT8
AC-ATT8-N

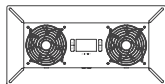

FAN
SYSTEM (x1)



THERMAL
PROBE (x1)



POWER
ADAPTER (x1)



WALL
ANCHORS (x4)



MACHINE
SCREWS (x4)

AIRTITAN T3

AC-ATT3



FAN
SYSTEM (x1)



THERMAL
PROBE (x1)



POWER
ADAPTER (x1)



UNIVERSAL
CONTROLLER (x1)



MACHINE
SCREWS (x4)

AIRTITAN T7

AC-ATT7

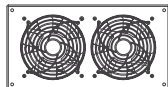

FAN
SYSTEM (x1)



THERMAL
PROBE (x1)



POWER
ADAPTER (x1)

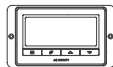

UNIVERSAL
CONTROLLER (x1)



MACHINE
SCREWS (x4)

MOUNTING

STEP 1

Remove any existing grilles, vents, or covers on ventilation opening where you wish to install the fan unit.

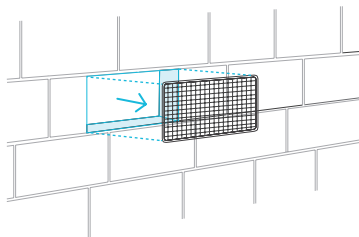

STEP 2

Position the fan unit over the ventilation opening. Depending on the model, the unit may be facing towards or away from the wall. Please be sure to check the airflow direction prior to installation.

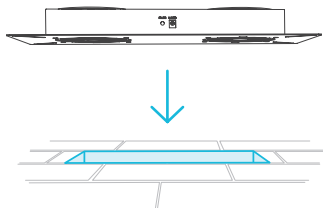

MOUNTING

STEP 3 (Foundation Block Mounting)

To install the unit onto a foundation brick or block, mark the mounting hole locations using the four corners of the metal face plate. Then drill 5/16" holes with a drill bit. Install wall anchors into openings and secure the unit into the wall with four screws. Note that the models T3 and T7 are designed for cabinet and wall mounting, and do not include wall anchors and larger type screws.

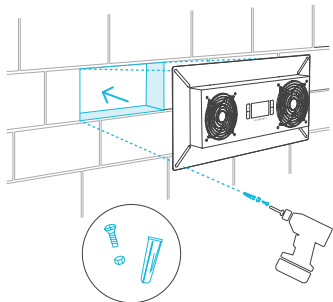

AIRTITAN T8, T8N Illustration shown above.

STEP 3 (Wall and Surface Mounting)

If installing the unit onto a cabinet, wall, wood header, rim joist, or mesh on an existing crawl space vent, please use the unit or plastic template to determine the mounting location. Secure the mounting frame onto the surface with the included wood screws. If using a machine screw with nuts, you may need to drill a hole. Note that models T8 and T8-N do not include a plastic template.

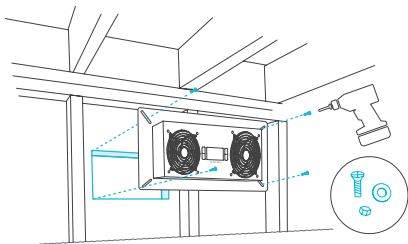

AIRTITAN T8, T8N Illustration shown above.

POWERING

AIRTITAN T8 T8-N

STEP 1

To set up temperature monitoring, plug the male connector of the thermal probe into the designated probe port located at the bottom side of the fan unit.

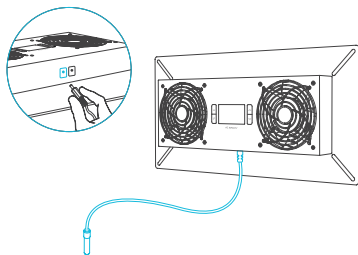

STEP 2

To power the unit plug in the power, plug the male connector of the corded power adapter into the designated power port located at the bottom side of the fan unit. Then plug the adapter head into an outlet.

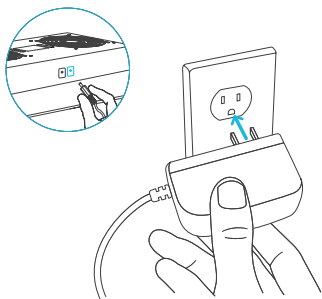

POWERING

AIRTITAN T3 T7

STEP 1

Plug the fan's male molex connector into one of the two designated probe ports located at the bottom side of the controller.

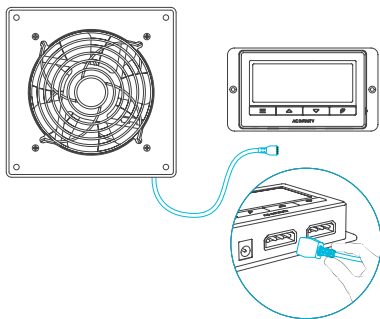

STEP 2

To power the unit plug in the power, plug the male connector of the corded power adapter into the designated power port located at the bottom side of the controller. Then plug the adapter head into an outlet.

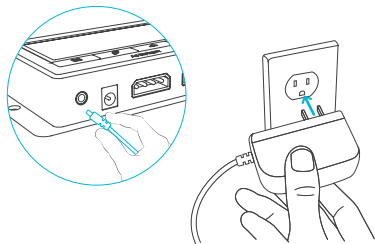

PROGRAMMING

1. MODE BUTTON

This button cycles through each of the controller's modes: ON, OFF, TIMER, AUTO (4 triggers), and ALARM (4 settings).

2. UP / DOWN BUTTON

The up and down buttons adjust the settings of the mode that you are in. Up button increases and down button decreases.

3. LEAF BUTTON

This turns the display off while programs run in the background. Hold for two seconds to lock or unlock the display.

(AIRTITAN T8, T8N Screen Display)

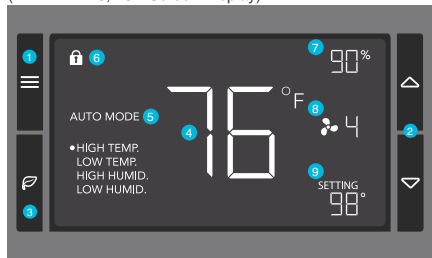

(AIRTITAN T3, T7 Screen Display)

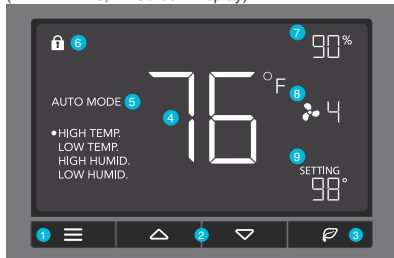

4. PROBE TEMP.

Displays the current temperature that the corded sensor probe is measuring. Shows "- -" if no probe is plugged in.

7. PROBE HUMIDITY

Displays the current humidity that the corded sensor probe is measuring. Shows "- -" if no probe is plugged in.

5. CONTROLLER MODE

This area displays the mode that the controller is currently in. Press the Mode Button to cycle through the modes.

8. FAN SPEED

Displays the current speed the fan is running at, or what speed it should be running at if no fans are plugged in.

6. ALERT ICONS

This area displays the alerts and statuses from the controller including alarms and screen lock.

9. SETTING

Displays the value you have set for the current mode. Press the up or down button to change.

PROGRAMMING

MODE SETTING

Press the Mode button to cycle through the controller's available programming modes and settings:
ON Mode, OFF Mode, TIMER Mode, AUTO Mode (4 triggers), ALARM Settings (4 settings).

ON MODE

In this mode, the fans will run continuously regardless of temperature or humidity. The speed set in this mode will be the max speed the fans can reach in AUTO Mode.

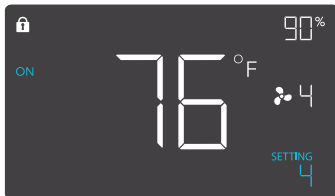

OFF MODE

In this mode, the fans will not run regardless of temperature or humidity. While in this mode, pressing the up or down button will change the display's brightness. There are four settings for brightness, (Setting: 1/2/3/A3). On setting A3, if the device is left unattended for 30 seconds, the display will automatically dim its brightness back to setting 1. Holding up or down button will change the display's units F or C.



TIMER MODE

In this mode, press the up or down button to set a time for the timer. The fans will run at the speed set in ON Mode until the timer's clock runs out, in which the fans will stop running. The clock will begin counting down if no buttons are pressed for 3 seconds. Leaving the timer mode while the countdown is running will pause the clock until you return to this mode.

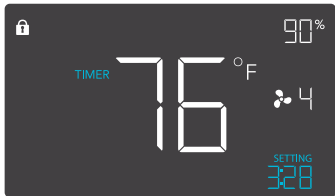

PROGRAMMING

AUTO MODE: HIGH TEMP.

In this mode, press the up or down button to set a high temperature trigger. The fans will activate if the probe's measured temperature exceeds the temperature you have set in this mode. The activated fans will slowly increase in speed until it reaches the speed set in ON Mode. Whenever the measured temperature falls below your set temperature, the fans will slowly decrease in speed until the fans stop. You may also hold the up and down button simultaneously to turn off this trigger, in which the digits under settings will show OFF for off. Note that this trigger can activate to run as long as you are in AUTO Mode, even if you are in setting up the other AUTO Mode triggers.

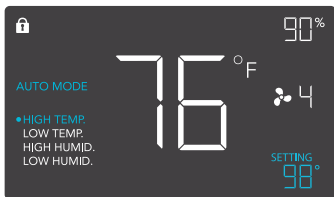

AUTO MODE: LOW TEMP.

In this mode, press the up or down button to set a low temperature trigger. The fans will activate if the probe's measured temperature falls below the temperature you have set in this mode. The activated fans will slowly increase in speed until it reaches the speed set in ON Mode. Whenever the measured temperature rises above your set temperature, the fans will slowly decrease in speed until the fans stop. You may also hold the up and down button simultaneously to turn off this trigger, in which the digits under settings will show OFF for off. Note that this trigger can activate to run as long as you are in AUTO Mode, even if you are in setting up the other AUTO Mode triggers.

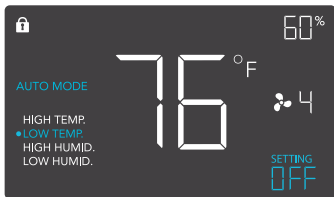

PROGRAMMING

AUTO MODE: HIGH HUMID.

In this mode, press the up or down button to set a high humidity trigger. The fans will activate if the probe's measured humidity exceeds the humidity you have set in this mode. The activated fans will slowly increase in speed until it reaches the speed set in ON Mode. Whenever the measured humidity falls below your set humidity, the fans will slowly decrease in speed until the fans stop. You may also hold the up and down button simultaneously to turn off this trigger, in which the digits under settings will show OFF for off. Note that this trigger can activate to run as long as you are in AUTO Mode, even if you are in setting up the other AUTO Mode triggers.

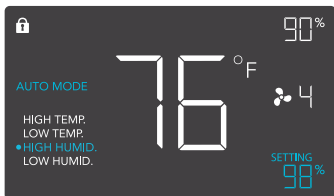

AUTO MODE: LOW HUMID.

In this mode, press the up or down button to set a low humidity trigger. The fans will activate if the probe's measured humidity falls below the humidity you have set in this mode. The activated fans will slowly increase in speed until it reaches the speed set in ON Mode. Whenever the measured humidity rises above your set temperature, the fans will slowly decrease in speed until the fans stop. You may also hold the up and down button simultaneously to turn off this trigger, in which the digits under settings will show OFF for off. Note that this trigger can activate to run as long as you are in AUTO Mode, even if you are in setting up the other AUTO Mode triggers.

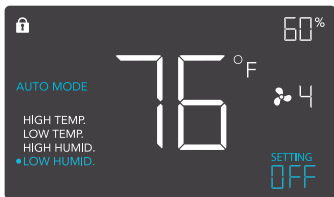

PROGRAMMING

ALARM SETTING: HIGH TEMP.

In this settings mode, press the up and down button to set a high temperature alarm. The alarm will activate if the probe's measured temperature exceeds the temperature you have set in this mode. When the alarm triggers, the fan will start spinning gradually to max speed regardless of your other settings. You may also hold the up and down button simultaneously to turn off this alarm, in which the digits under settings will show OFF. You will need to be in AUTO, ON, or TIMER mode for this alarm to be able to activate.

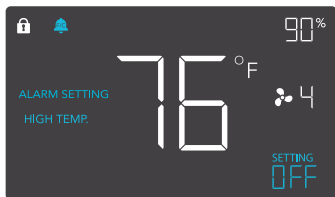

ALARM SETTING: LOW TEMP.

In this settings mode, press the up and down button to set a low temperature alarm. The alarm will activate if the probe's measured temperature falls below the temperature you have set in this mode. When the alarm triggers, the fan will start spinning gradually to max speed regardless of your other settings. You may also hold the up and down button simultaneously to turn off this alarm, in which the digits under settings will show OFF. You will need to be in AUTO, ON, or TIMER mode for this alarm to be able to activate.

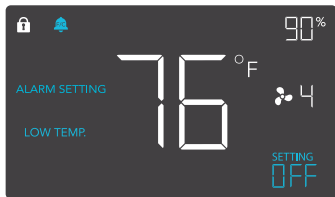

PROGRAMMING

ALARM SETTING: HIGH HUMID.

In this settings mode, press the up and down button to set a high humidity alarm. The alarm will activate if the probe's measured humidity exceeds the humidity you have set in this mode. When the alarm triggers, the fan will start spinning gradually to max speed regardless of your other settings. You may also hold the up and down button simultaneously to turn off this alarm, in which the digits under settings will show OFF. You will need to be in AUTO, ON, or TIMER mode for this alarm to be able to activate.

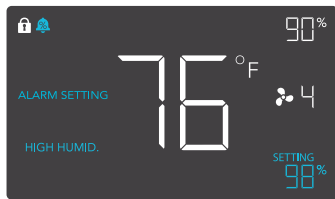

ALARM SETTING: LOW HUMID.

In this settings mode, press the up and down button to set a low humidity alarm. The alarm will activate if the probe's measured temperature falls below the temperature you have set in this mode. When the alarm triggers, the fan will start spinning gradually to max speed regardless of your other settings. You may also hold the up and down button simultaneously to turn off this alarm, in which the digits under settings will show OFF. You will need to be in AUTO, ON, or TIMER mode for this alarm to be able to activate.

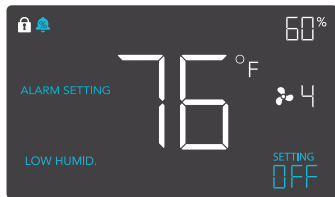

PROGRAMMING

FAHRENHEIT OR CELSIUS

To change to displayed units between Fahrenheit and Celsius, please set the controller to OFF Mode, then hold the up button for Fahrenheit (°F) or hold the down button for Celsius (°C).

DISPLAY BRIGHTNESS

To adjust the brightness of the display, please set the controller to OFF Mode, then press the up or down button to increase or decrease the brightness level. Four brightness settings are available.

TEMPERATURE CALIBRATION

To adjust the temperature that the probe sensor is measuring, please press the MODE and UP button simultaneously. This can be done while the controller is any mode or setting. The calibration cycle ranges from -8°F to 8°F (or -4°C to 4°C) and will be applied to the probe sensor's measurements.

HUMIDITY CALIBRATION

To adjust the humidity that the probe sensor is measuring, please press the MODE and DOWN button simultaneously. This can be done while the controller is any mode or setting. The calibration cycle ranges from -8% to 8% and will be applied to the probe sensor's measurements.

CONTROLLER LOCK

To lock the controller to prevent settings to be changed accidentally, hold the LEAF button for two or more seconds. While the display is locked, you will not be able to switch modes or changes any settings. You will only be able to put the controller in ECO display by pressing the LEAF button. Holding the LEAF button for two or more seconds will unlock the controller.

ECO-MODE

The controller can be put into ECO display in which the screen will be turned off but all programs, settings, and alarms will be running in the background. This can be done by pressing the LEAF button. You may also do this while the controller is locked. To exit ECO display, simply press any buttons.

PROGRAMMING

ALERT ICONS

On the top left of the display is the alert icon section. Icons may flash when the controller wishes to alert you that a particular function or alarm is being triggered.

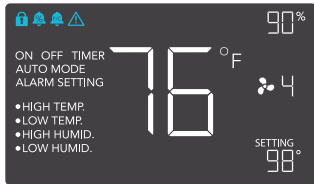

DISPLAY LOCK ALERT

This icon is visible when the controller has been locked. The icon will flash to alert you that the controller is locked if you try to change the mode or settings.



HUMIDITY ALARM ALERT

This icon will flash when the high or low humidity alarm that you have set has been triggered.



TEMPERATURE ALARM ALERT

This icon will flash when the high or low temperature alarm that you have set has been triggered.



CHECK FAN ALERT

This icon will flash when the fan's sensor detects interference to its operation. Please check the fan for possible issues. If the fan is rotating, it may just be static pressure resistance and operating as intended. If the fan is not rotating, please see the warranty page for replacement information. (This feature is only available on certain model.)

AIRTITAN FAQ

Q: Can I mount this crawlspace fan vertically?

A: Yes. The AIRTITAN can be mounted in any orientation, including vertically.

Q: Can I splice the cables to extend them or use my own probe?

A: We do not recommend hardwiring or splicing our fan's power wires. Such modifications may compromise electrical safety and will void this product's warranty.

Q: How do I reverse the airflow of my crawlspace fan?

A: To flip the fan blades, unscrew the bolts from the steel plate and the body. Flip the fans within the body and screw the bolts back in.

Q: How far can I mount the controller from the fan?

A: You may mount the controller up to six feet away from the fan, which is the length of the cable.

Q: Does the controller retain its settings after power is shut off?

A: Yes. If the controller's power is cut off and is powered on afterwards, your settings will remain.

Q: Does this fan include grilles for outside installation or duct tubes for wall installation?

A: This product does not come included with ducting or grilles as accessories.

Q: Is this fan waterproof?

A: The AIRTITAN is IP44 rated for resistance against splashing water.

Q: Will this fan help with Radon mitigation?

A: Yes. The AIRTITAN will ventilate your crawlspace to exhaust radon gas emitting from soil.

Q: Do I need to use both an intake and an exhaust model?

A: You will at least need to use an exhaust fan for crawlspace applications. Intake fans are optional.

AC INFINITY PRODUCTS

Register Booster Fans

The AIRTAP series is a line of register booster fans designed to quietly increase airflow coming from your central heat and air conditioning systems, increasing comfort for your home. Features a thermal controller with intelligent programming that will automatically adjust airflow strength in response to heating and cooling temperatures you have set.

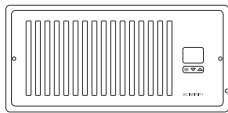

Duct Fans

The CLOUDLINE series is a line of duct fans designed to quietly ventilate AV rooms and closets, as well as various DIY air circulation and exhaust projects. Features a thermal controller with intelligent programming that will automatically adjust duct fan speeds in response to changing temperatures.



Project Muffin Fans

The AXIAL series fan kit is designed for various DIY projects that requires cooling or ventilation; or as a replacement fan for many products on the market. Each fan kit includes fan guards and everything needed to mount the unit onto a wall and power it through a wall outlet. S-series models include a speed controller.

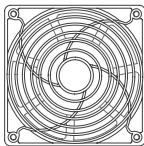

Discover the latest innovations in cooling and ventilation at acinfinity.com

WARRANTY

This warranty program is our commitment to you, the product sold by AC Infinity will be free from defects in manufacturing for a period of two years from the date of purchase. If a product is found to have a defect in material or workmanship, we will take the appropriate actions defined in this warranty to resolve any issues.

The warranty program applies to any order, purchase, receipt, or use of any products sold by AC Infinity or our authorized dealerships. The program covers products that have become defective, malfunctioned, or expressively if the product becomes unusable. The warranty program goes into effect on the date of purchase. The program will expire two years from the date of purchase. If your product becomes defective during that period, AC Infinity will replace your product with a new one or issue you a full refund.

The warranty program does not cover abuse or misuse. This includes physical damage, submersion of the product in water, incorrect installation such as wrong voltage input, and misuse for any reason other than intended purposes. AC Infinity is not responsible for consequential loss or incidental damages of any nature caused by the product. We will not warrant damage from normal wear such as scratches and dings.

For more information about our dealers and distributors, please contact our customer service at support@acinfinity.com or (626) 923-6399 Monday to Friday (9:00 am to 5:00 pm PST).



If you have any issues with this product, contact us and we'll happily resolve your problem or issue a full refund!

COPYRIGHT © 2021 AC INFINITY INC. ALL RIGHTS RESERVED

No part of the materials including graphics or logos available in this booklet may be copied, photocopied, reproduced, translated or reduced to any electronic medium or machine readable form, in whole or in part, without specific permission from AC Infinity Inc.

www.acinfinity.com