

Use & Care Guide
Guía de uso y cuidada
English / Español

Model/Modelos: 790.9415*

Kenmore®

Electric Range

Estufa eléctrica

* = color number, número de color

P/N 807190701 Rev C

Sears Brands Management Corporation
Hoffman Estates, IL 60179 U.S.A.

www.kenmore.com
www.sears.com



Table of Contents

Please carefully read and save these instructions	2	Surface element settings	10
Kenmore Limited Warranty	2	Before Setting Oven Controls	11
Before Setting Surface Controls	8	Oven vent location	11
Using proper cookware	8	Oven Controls	12
Cookware Material Types	8	Minimum and Maximum Control Settings	12
About the surface elements	8	Self Clean	20
Home Canning	9	Care & Cleaning	23
Element On indicator lights	9	Before You Call	27
Setting Surface Controls.....	10	Oven Baking	27
		Solutions to Common Problems	28

Please carefully read and save these instructions

This Use & Care Guide contains operating instructions for your appliance and feature information for several models. Your product may not have all the described features. The graphics shown are representative. The graphics on your appliance may not look exactly like those shown. Common sense and caution must be practiced with installing, operating and maintaining any appliance.

Kenmore Limited Warranty

When installed, operated and maintained according to all instructions supplied with the product, if this appliance fails due to a defect in material and workmanship within one year from the date of purchase, call 1-800-4-MY-HOME® to arrange for free repair. This warranty applies for only 90 days from the date of purchase if this appliance is ever used for other than private family purposes.

This warranty covers only defects in material and workmanship. Sears will NOT pay for:

1. Cracks in a ceramic glass cooktop that are not a result of thermal shock.
2. Stains and scratches on a ceramic glass cooktop resulting from failure to maintain it properly according to all instructions supplied with the product.
3. Expendable items that can wear out from normal use, including but not limited to filters, belts, light bulbs, and bags.
4. A service technician to instruct the user in correct product installation, operation or maintenance.
5. A service technician to clean or maintain this product.
6. Damage to or failure of this product if it is not installed, operated or maintained according to all instructions supplied with the product.
7. Damage to or failure of this product resulting from accident, abuse, misuse or use for other than its intended purpose.
8. Damage to or failure of this product caused by the use of detergents, cleaners, chemicals or utensils other than those recommended in all instructions supplied with the product.
9. Damage to or failure of parts or systems resulting from unauthorized modifications made to this product.

Disclaimer of implied warranties; limitation of remedies

Customer's sole and exclusive remedy under this limited warranty shall be product repair as provided herein. Implied warranties, including warranties of merchantability or fitness for a particular purpose, are limited to one year or the shortest period allowed by law. Sears shall not be liable for incidental or consequential damages. Some states and provinces do not allow the exclusion or limitation of incidental or consequential damages, or limitation on the duration of implied warranties of merchantability or fitness, so these exclusions or limitations may not apply to you.

This warranty applies only while this appliance is used in the United States.

This warranty gives you specific legal rights, and you may also have other rights which vary from state to state.

Sears Brands Management Corporation, Hoffman Estates, IL 60179 U.S.A.



IMPORTANT SAFETY INSTRUCTIONS

Read all instructions before using this appliance.

Read all instructions before using this appliance.

This manual contains important safety symbols and instructions. Pay attention to these symbols and follow all instructions given.

Do not attempt to install or operate your appliance until you have read the safety precautions in this manual. Safety items throughout this manual are labeled with a WARNING or CAUTION statement based on the hazard type.

DEFINITIONS

⚠ This is the safety alert symbol. It is used to alert you to potential personal injury hazards. Obey all safety messages that follow this symbol to avoid possible injury or death.

⚠ WARNING - Indicates a potentially hazardous situation which, if not avoided, may result in death or serious injury.

⚠ CAUTION - Indicates a potentially hazardous situation which, if not avoided, may result in minor or moderate injury.

Important: Indicates installation, operation, maintenance, or valuable information that is not hazard related.

⚠ WARNING Storage In or On Appliance—Flammable materials should not be stored in an oven, near surface units or in the storage drawer, warmer drawer or lower oven. This includes paper, plastic, and cloth items, such as cookbooks, plastic ware, and towels, as well as flammable liquids. Do not store explosives, such as aerosol cans, on or near the oven.

⚠ WARNING Tip Over Hazard

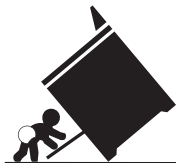

- A child or adult can tip the range and be killed.
- Verify the anti-tip device has been installed to floor or wall.

- Ensure the anti-tip device is re-engaged to floor or wall when the range is moved.
- Do not operate the range without the anti-tip device in place and engaged.
- Failure to follow these instructions can result in death or serious burns to children and adults.



To check if the anti-tip bracket is installed properly, use both arms and grasp the rear edge of the range back. Carefully attempt to title range forward. When properly installed, the range should not tilt forward.

Refer to the anti-tip bracket installation instructions supplied with your range for proper installation.

⚠ WARNING Do Not Leave Children Alone - Children should not be left alone or unattended in the area where appliance is in use. They should never be allowed to sit or stand on any part of the appliance, including the storage drawer, lower broiler drawer, warmer drawer, or lower double oven.

IMPORTANT SAFETY INSTRUCTIONS

Read all instructions before using this appliance.

⚠ WARNING Stepping, leaning, or sitting on the door or drawers of a range can result in serious injuries and also cause damage to the appliance. Do not allow children to climb or play around the range. The weight of a child on an open oven door may cause the range to tip, resulting in serious burns or other injury.

⚠ WARNING Never cover any slots, holes, or passages in the oven bottom or cover an entire oven rack with materials, such as aluminum foil. Aluminum foil linings may trap heat, causing a fire hazard.

⚠ CAUTION Wear proper apparel. Loose-fitting or hanging garments should never be worn while using this appliance. Do not let clothing or other flammable materials come into contact with hot surfaces.

⚠ CAUTION Do not heat unopened food containers. Build-up of pressure may cause container to burst and result in injury.

⚠ CAUTION When heating fat or grease, watch it closely. Grease may catch fire if it becomes too hot.

⚠ CAUTION Do not use water or flour on grease fires. Smother fire or flame or use dry chemical or foam-type extinguisher. Cover the fire with a pan lid or use baking soda.

⚠ CAUTION Use dry potholders. Moist or damp potholders on hot surfaces may result in burns from steam. Do not let potholders touch hot cooking areas. Do not use towels or other bulky cloths.

Important: Important Safety Notice - The California Safe Drinking Water and Toxic Enforcement Act requires the governor of California to publish a list of substances known to cause cancer, birth defects, or other reproductive harms, and it requires businesses to warn customers of potential exposures to such substances.

⚠ CAUTION Read and follow the below instructions and precautions for unpacking, installing, and servicing your appliance:

- Remove all tape and packaging before using the range. Destroy the carton and plastic bags after unpacking the range. Never allow children to play with packaging material.
- Proper Installation—Be sure your appliance is properly installed and grounded by a qualified technician in accordance with the National Electrical Code ANSI/NFPA No. 70 latest edition and local electrical code requirements. In Canada, install in accordance with CSA Standard C22.1, Canadian Electrical code, Part 1, and local electrical code requirements. Install only per installation instructions provided in the literature package for this oven.
- User Servicing—Do not repair or replace any part of the appliance unless specifically recommended in the manuals. All other servicing should be done only by a qualified technician. This reduces the risk of personal injury and damage to the range.
- Ask your dealer to recommend a qualified technician and an authorized repair service. Know how to disconnect the power to the oven at the circuit breaker or fuse box in case of an emergency.
- Never modify or alter the construction of a range by removing the leveling legs, panels, wire covers, anti-tip brackets/screws, or any other part of the range.
- Remove the oven door from any unused range if it is to be stored or discarded.

Save these instructions for future reference.

IMPORTANT SAFETY INSTRUCTIONS

Read all instructions before using this appliance.

- Do not attempt to operate the range during a power failure. If the power fails, always turn off the range. If the range is not turned off and the power resumes, the range will begin to operate again. Once the power resumes, reset the clock and oven function.
- Cold temperatures can damage the electronic control. When using this appliance for the first time, or when the appliance has not been used for an extended period of time, be sure the appliance has been in temperatures above 32°F (0°C) for at least 3 hours before turning on the power to the appliance.
- Be sure to have an appropriate foam-type fire extinguisher available, visible, and easily located near the appliance.
- Placement of Oven Racks - Always place oven racks in desired location while oven is cool. If rack must be moved while oven is hot, use extreme caution and do not let potholder contact hot heating element in oven. Use potholders and grasp the rack with both hands to reposition. Remove all bakeware and utensils before moving the rack.
- Do not use a broiler pan without its insert. Broiler pans and inserts allow dripping fat to drain away from the high heat of the broiler. Do not cover the broiler insert with aluminum foil; exposed fat and grease could ignite.
- Protective Liners - Do not use aluminum foil to line surface unit drip bowls or oven bottoms, except as suggested in the manual. Improper installation of these liners may result in a risk of electric shock, or fire.

IMPORTANT INSTRUCTIONS FOR USING YOUR OVEN

- Never use your appliance for warming or heating the room.
- Use care when opening oven door, lower oven door, or warmer drawer (some models). Stand to the side of the range when opening the door of a hot oven. Let hot air or steam escape before you remove or replace food in the oven.
- Keep oven vent ducts unobstructed. The oven vent is located below the backguard. Touching surfaces in this area when the oven is on may cause severe burns. Do not place plastic or heat-sensitive items on or near the oven vent. These items can melt or ignite.

IMPORTANT INSTRUCTIONS FOR USING YOUR COOKTOP

- Know which knob controls each surface heating unit. Place a pan of food on the surface element unit before turning it on, and turn the element off before removing the pan.
- Use proper pan size — This appliance is equipped with one or more surface units of different sizes. Select utensils having flat bottoms large enough to cover the surface unit heating element. The use of undersized utensils will expose a portion of the heating element to direct contact and may result in ignition of clothing. Proper relationship of utensil to element will also improve efficiency.

Save these instructions for future reference.

IMPORTANT SAFETY INSTRUCTIONS

Read all instructions before using this appliance.

- Utensil handles should be turned inward and not extend over adjacent surface elements — To reduce the risk of burns, ignition of flammable materials, and spillage due to unintentional contact with the utensil, the handle of the utensil should be positioned so that it is turned inward, and does not extend over adjacent surface units.
- Never leave surface elements unattended at high heat settings — Boilovers cause smoking and greasy spillovers that may ignite, or a pan that has boiled dry may melt.
- Glazed cooking utensils — Only certain types of glass, glass/ceramic, ceramic, earthenware, or other glazed utensils are suitable for cook top service without breaking due to the sudden change in temperature. Check the manufacturer's recommendations for cook top use.
- When flaming foods under a ventilating hood, turn the fan on.
- Improper cookware may break due to sudden changes in temperature. Check the cookware manufacturer's recommendations for cooktop use.
- Do not use decorative surface burner covers. If an element is accidentally turned on, the decorative over will become hot and possibly melt. Burns will occur if the hot covers are touched. Damage may also be done to the cooktop.

IMPORTANT INSTRUCTIONS ON COOKTOPS WITH COIL ELEMENTS

⚠ CAUTION Protective liners — Do not use aluminum foil to line surface unit drip bowls, or reflector pans. Only use aluminum foil as recommended in this manual. Improper installation of these liners may result in risk of electric shock, or fire.

- Make sure reflector pans or drip bowls are in place. Absence of these pans or bowls during cooking may subject wiring or components underneath to damage.
- Do not immerse or soak removable surface heating elements. Surface heating elements should never be immersed in water. Heating elements clean themselves during normal operation.
- Carefully check the reflector pans, drip bowls, and coils for packaging material. Remove all packaging material before using the cooktop.
- Do not use decorative surface burner covers. If an element is accidentally turned on, the decorative cover will become hot and possibly melt. Burns will occur if the hot covers are touched. Damage may also be done to the cooktop.
- Do not allow grease to accumulate around surface burners and drip bowls.

IMPORTANT INSTRUCTIONS FOR CLEANING YOUR RANGE

⚠ CAUTION Before manually cleaning any part of the range, be sure all controls are turned off and the range is cool. The range may be hot and can cause burns.

- Clean the range regularly to keep all parts free of grease that could catch fire. Pay particular attention to the area around each surface element. Do not allow grease to accumulate.

Save these instructions for future reference.

IMPORTANT SAFETY INSTRUCTIONS

Read all instructions before using this appliance.

- Always follow the manufacturer's recommended directions for use of kitchen cleaners and aerosols. Be aware that excess residue from cleaners and aerosols may ignite causing damage and injury.
- Clean ventilating hoods frequently. Grease should not be allowed to accumulate on the hood or filter. Follow the manufacturer's instructions for cleaning hoods.

IMPORTANT INSTRUCTIONS FOR CLEANING YOUR SELF-CLEANING OVENS

- Clean only the parts listed in this manual. Before using self-clean, remove the broiler pan, any food, utensils, and bakeware from the oven. Remove oven racks unless otherwise instructed.
- Do Not Use Oven Cleaners. No commercial oven cleaner or oven liner protective coating of any kind should be used in or around any part of the oven.
- Do Not Clean Door Gasket. The door gasket is essential for a good seal. Care should be taken not to rub, damage, or move the gasket.
- Some birds are extremely sensitive to the fumes given off during the self-clean cycle of any oven. Move birds to another well-ventilated room.

⚠ CAUTION DO NOT TOUCH SURFACE HEATING UNITS, OR SURFACE COOKING ELEMENTS, AREAS NEAR THESE SURFACE HEATING UNITS, OR INTERIOR SURFACE OF THE OVEN. Both surface heating and oven heating elements may be hot even though they are dark in color. Areas near surface cooking units may become hot enough to cause burns. During and after use, do not touch, or let clothing or other flammable materials touch these areas until they have had sufficient time to cool. Among these areas are the cook top, surfaces facing the cook top, the oven vent openings and surfaces near these openings, oven door and oven door window.

GROUNDING INSTRUCTIONS

⚠ WARNING Do not use an adapter plug or an extension cord, or remove grounding prong from the power cord. Failure to follow this warning may cause serious injury, fire, or death.

For personal safety, this appliance must be properly grounded.

For models factory-equipped with a power cord:

For maximum safety, the power cord must be plugged into an electrical outlet that is the correct voltage, is correctly polar-ized, and is properly grounded in accordance with local codes.

For ovens to be wired into a junction box:

It is the personal responsibility of the consumer to have the appropriate outlet with the correct, properly grounded wall receptacle installed by a qualified electrician. See the installation instructions packaged with this appliance for complete installation and grounding instructions.

Save these instructions for future reference.

Before Setting Surface Controls

Using proper cookware

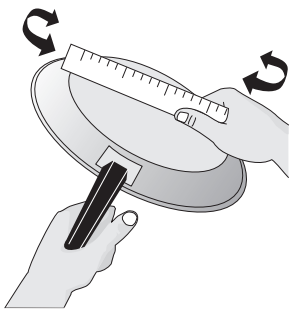

The size and type of cookware used will influence the radiant element power level setting needed for best cooking results. Be sure to follow the recommendations for using proper cookware as illustrated in both [Figure 1](#) and [Figure 2](#).

Figure 1: Testing cookware

Check for flatness by rotating a ruler across the bottom of the cookware (See [Figure 1](#)). Cookware should have flat bottoms that make good contact with the entire surface heating element (See [Figure 2](#)). For detailed information about the ceramic cooktop, refer to the “[General Cleaning](#)” section starting on [page 24](#) of the Care & Cleaning chapter.

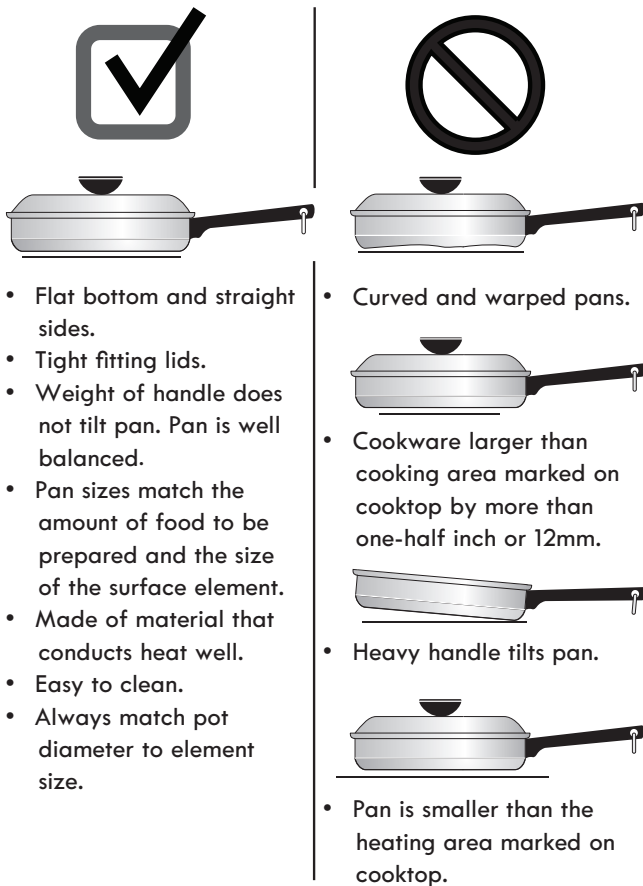

- Flat bottom and straight sides.
- Tight fitting lids.
- Weight of handle does not tilt pan. Pan is well balanced.
- Pan sizes match the amount of food to be prepared and the size of the surface element.
- Made of material that conducts heat well.
- Easy to clean.
- Always match pot diameter to element size.

- Curved and warped pans.
- Cookware larger than cooking area marked on cooktop by more than one-half inch or 12mm.
- Heavy handle tilts pan.
- Pan is smaller than the heating area marked on cooktop.

Figure 2: Proper cookware placement

Cookware Material Types

The cookware material determines how evenly and quickly heat is transferred from the surface element to the pan bottom. The most popular materials available are:

Aluminum - Excellent heat conductor. Some types of food will cause it to darken (Anodized aluminum cookware resists staining and pitting).

Copper - Excellent heat conductor but discolors easily (See Aluminum).

Stainless - Slow heat conductor with uneven cooking results. Is durable, easy to clean and resists staining.

Cast Iron - A slow heat conductor however will retain heat very well. Cooks evenly once cooking temperature is reached.

Porcelain-enamel on metal - Heating characteristics will vary depending on base material.

Glass - Slow heat conductor.

About the surface elements

The element temperature rises gradually and evenly. As the temperature rises, the element will glow red. For efficient cooking, turn OFF the surface element just before cooking is complete. This will allow residual heat to complete the cooking process.

CAUTION Surface elements may appear to have cooled after they have been turned off. The surface element may still be hot and burns may occur if the surface element is touched before it has cooled sufficiently.

CAUTION Do not place plastic items such as salt and pepper shakers, spoon holders or plastic wrappings on top of the range when it is in use. These items could melt or ignite. Potholders, towels or wooden spoons could catch fire if placed too close to the surface elements.

CAUTION Do not use aluminum foil to line surface unit drip bowls, or reflector pans. Only use aluminum foil as recommended in this manual. Improper installation of these liners may result in risk of electric shock, or fire.

Do not place aluminum foil or any material that could melt on the surface elements.

Make sure reflector pans or drip bowls are in place —Absence of these pans or bowls during cooking may subject wiring or components underneath to damage.

Home Canning

⚠ CAUTION Canning can generate large amounts of steam. Use extreme caution to prevent burns. Always raise the lid to vent steam away from you. Safe canning requires that harmful micro-organisms are destroyed and the jars are sealed completely. When canning in a water bath canner, a gentle but steady boil must be maintained continuously for the required time.

Be sure to read and observe all the following points when home canning with your appliance. Check with the USDA (United States Department of Agriculture) Web site and be sure to read all the information they have available as well as follow their recommendations for home canning procedures.

- Use only quality flat bottom canners when home canning. Use a straight-edge to check canner bottom.
- Use only a completely flat bottom canner with no ridges that radiate from the bottom center when home canning. Heat is spread more evenly when the bottom surface is flat.
- Make sure the diameter of the canner does not exceed 1 inch beyond the surface element markings or burner. It is recommended to use smaller diameter canners on electric coil and ceramic glass cooktops and to center canners on the burner grates.
- Start with hot tap water to bring water to boil more quickly.
- Use the highest heat setting when first bringing the water to a boil. Once boiling is achieved, reduce heat to lowest possible setting to maintain that boil.
- Use tested recipes and follow instructions carefully. Check with your local Cooperative Agricultural Extension Service or a manufacturer of glass jars for the latest canning information.
- It is best to can small amounts and light loads.
- Do not leave water bath or pressure canners on high heat for an extended amount of time.
- Alternate surface units between each batch to allow the units and surrounding surfaces to cool down. Try to avoid canning on the same burner unit all day.

Element On indicator lights

The ELEMENT ON indicator lights are marked on the control panel and will glow when a surface cooking element is turned on. A quick glance at these indicator lights after cooking is an easy check to be sure all surface controls are turned off.

Important note:

Never place or straddle a cooking utensil over two different surface cooking elements at the same time unless the utensil is designed for that purpose. This can cause uneven heating results. This can also cause the ceramic cooktop to fracture (for ceramic cooktop models only).

ELEMENT ON 

Figure 3: Element indicator light

Setting Surface Controls

Surface element settings

⚠ CAUTION Surface elements may appear to have cooled after they have been turned off. The surface element may still be hot and burns may occur if the surface element is touched before it has cooled sufficiently.

⚠ CAUTION Do not place plastic items such as salt and pepper shakers, spoon holders or plastic wrappings on top of the range when it is in use. These items could melt or ignite. Potholders, towels or wooden spoons could catch fire if placed too close to the surface elements.

The size and type of utensil used, and the amount and type of food being cooked will influence the surface element power level setting needed for best cooking results. The suggested settings found in [Table 1](#) are based when cooking with medium-weight aluminum pans with lids. Settings may vary when using other types of pans.

Table 1: Suggested settings for surface elements

Settings	Type of cooking
High (HI)	Start most foods, bring water to a boil, pan broiling
Medium high (7 - 8)	Continue a rapid boil, fry, deep fat fry
Medium (5 - 6)	Maintain a slow boil, thicken sauces and gravies or steam vegetables
Medium Low (2 - 4)	Keep foods cooking, poach, stew
Low (LO - 1)	Keep warm, melt, simmer

To operate the surface elements:

1. Place correctly sized cookware on surface element.
2. Push in and turn the surface control knob in either direction to the desired setting (See [Figure 4](#)).
3. When cooking is complete, turn the surface element to the OFF position before removing the cookware.

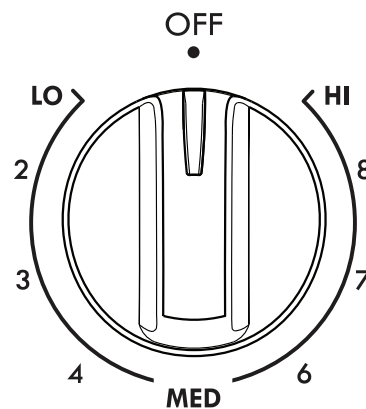

Figure 4: Surface control knob

Important notes:

- The surface control knobs do not have to be set exactly on a particular spot (See [Figure 4](#)). Use the graphics provided as a guide and adjust the control knob as needed. Refer to [Table 1](#) for suggested power level settings.
- Start most cooking operations on a higher setting and then turn to a lower setting to finish cooking.
- The ELEMENT ON indicator light(s) will glow when one or more surface elements are turned ON. A quick glance at these indicator lights when finished surface cooking is an easy check to be sure all surface controls are turned OFF.

Before Setting Oven Controls

Oven vent location

The oven vent is located under the left rear surface element. When the oven is on, warm air passes through this vent. This venting is necessary for proper air circulation in the oven and good baking results. Do not block oven vent.

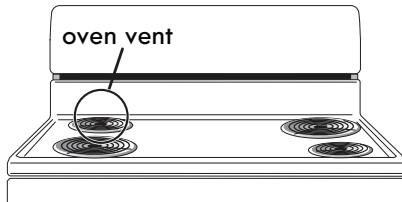

Figure 5: Do not block oven vent location

⚠ WARNING Protective Liners — Do not use aluminum foil to line the oven bottom. Only use aluminum foil as recommended in this manual. Improper installation of these liners may result in risk of electric shock or fire.

⚠ CAUTION Always use pot holders or oven mitts when using the oven. When cooking, the oven interior and exterior, as well as the oven racks, will become very hot which can cause burns.

Removing, replacing, and arranging flat or offset oven racks

To Arrange - Always arrange the oven racks when the oven is cool (prior to operating the oven).

To Remove - Pull the oven rack straight forward until it reaches the stop position. Lift up front of oven rack slightly and slide out.

To Replace - Place the oven rack on the rack guides on both sides of oven walls. Tilt the front of oven rack upward slightly and slide the oven rack back into place. Be sure oven racks are level before using.

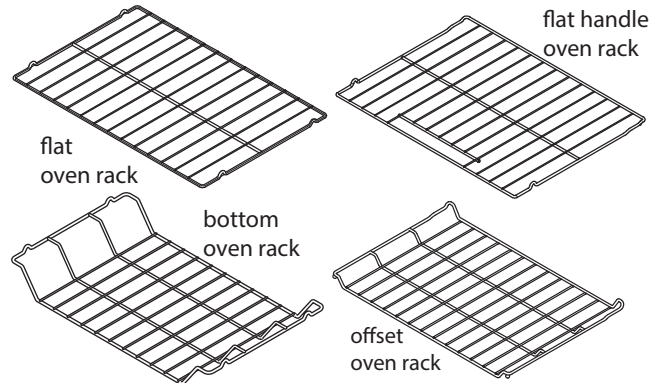

Figure 6: Oven rack types

Oven Rack Descriptions

- Flat oven racks (or the flat handle oven rack) may be used for most cooking needs and may be placed in most oven rack positions.
- The offset oven rack (some models) provides additional stepdown positions from the standard flat rack design. The offset design positions the base of the rack about 1/2 of a rack position lower than the flat rack and may be used in most oven rack positions.
- To maximize oven cooking space, place the bottom oven rack (some models) in the lowest rack position for baking or roasting large cuts of meat.

Air circulation in the oven

For best baking results allow 2-4" (5-10 cm) around the cookware for proper air circulation and be sure pans and cookware do not touch each other, the oven door, sides or back of the oven cavity. Hot air must be able to circulate around the cookware in the oven for even heat to reach around the food.

Oven Controls

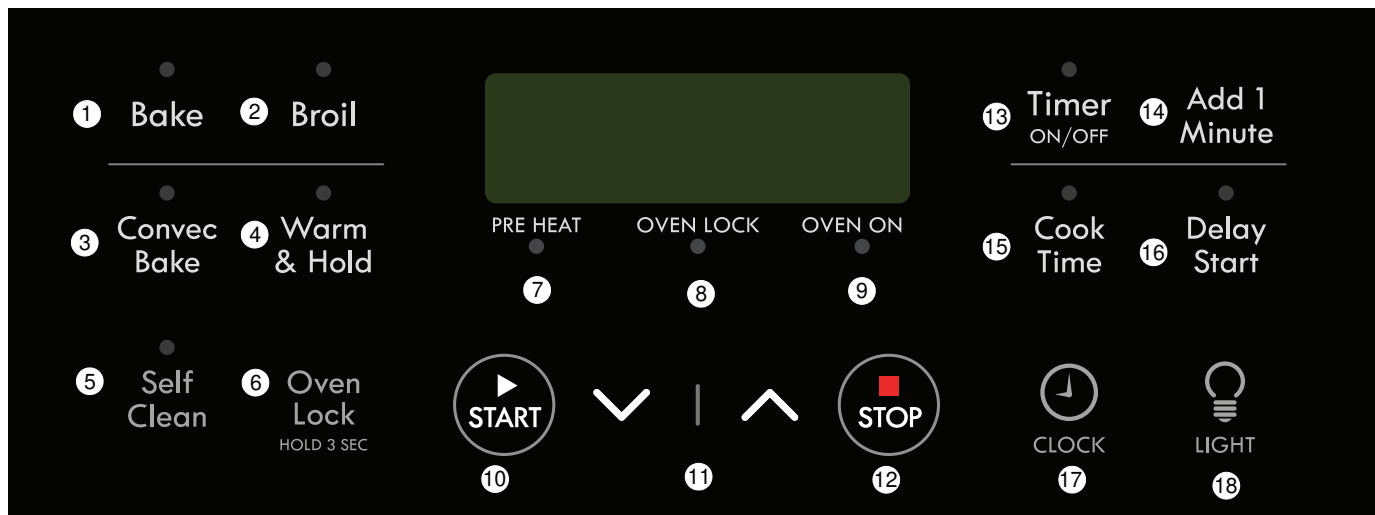

1. **Bake** - Selects Bake function.
2. **Broil** - Selects Broil function.
3. **Convec Bake** - Use to set convection feature.
4. **Warm & Hold** - Use to keep cooked food warm and at serving temperature for up to 3 hours.
5. **Self Clean** - Use to select 2, 3, or 4hr Self-Clean cycle.
6. **Oven Lock** - Use to lock oven door and oven functions.
7. **PREHEAT indicator light** - Is on when oven is preheating. Stays on until the oven reaches the desired temperature.
8. **OVEN LOCK indicator light** - Is on when door locks or unlocks and when oven lockout is active.
9. **OVEN ON indicator light** - Glows each time the oven cycles on to maintain the set oven temperature.
10. **START** - Use to start all cooking functions.
11. **Up / Down arrows** - Use with the function keys to accept settings and adjust temperature and times.
12. **STOP** - Cancels any active oven function except clock and timer.
13. **Timer ON/Off** - Use to set and cancel the timer and to set the Continuous Bake feature.
14. **Add 1 Minute** - Use to add one minute to the timer. This works with the kitchen timer and does not affect any cook time or start time functions.
15. **Cook Time** - Use to set a specific amount of time needed for cooking. Automatically cancels cooking process at end of set time.
16. **Delay Start** - Use with Bake and Self Clean functions to program a delayed start bake or delayed start self clean cycle.
17. **CLOCK** - Use with arrow keys to set time of day.

18. **LIGHT** - Use to turn internal oven light on and off.

Minimum and Maximum Control Settings

All of the features listed have minimum and maximum time and temperature settings that may be entered into the control. An entry acceptance beep will sound each time a key is touched (the Oven Lockout tone is delayed by 3 seconds). An entry error tone (three short beeps) will sound if the entry of the temperature or time is below the minimum or above the maximum settings for the feature.



Table 2: Minimum and maximum control settings

Feature	Min. Temp or Time	Max. Temp or Time
Bake	170°F (77°C)	550°F (288°C)
Broil	LO	Hi
Timer	1 minute	11 hrs. 59 mins.
Self Clean	2 Hours	4 Hours
Warm & Hold	170°F (77°C)	3 Hours
Cook Time	1 Minute	11:59
Delay Time 12 Hr.	1:00	12:59
Delay Time 24 Hr.	0:00	23:59
Clock 12 Hr.	1:00	12:59
Clock 24 Hr.	0:00	23:59

Setting Clock

When the appliance is first powered up or when the power supply to the appliance has been interrupted, **12:00** will flash in the display. The time of day must first be set before operating the oven.

To set the clock

1. Press **CLOCK** once. **CLO** appears in display.
2. Press  or  and the time appears in the display. Continue to hold arrow key until the correct time of day appears in the display.
3. Press **START** to accept time of day.

Important note:

The time of day cannot be changed when the oven is set for cooking.

Oven Lock

The Oven Lock feature allows you to lock the oven portion of the appliance while the oven is not in use.

To activate Oven Lock feature:

1. Be sure the door is completely closed.
2. Press and hold **Oven Lock** for 3 seconds. **Loc** will appear in the display. The OVEN LOCK indicator light will flash while the motor driven door latch begins locking the oven door. Do not open the door during this time. Allow 15 seconds for the door to completely lock. Once oven door is locked, the time of day will appear in the display.

To cancel the Oven Lock feature:



1. Press and hold **Oven Lock** for 3 seconds. The OVEN LOCK indicator light will flash and the motor driven door latch will begin to unlock. Do not open the door at this time. The door will unlock completely in about 15 seconds.
2. The oven control keys will be available, and the oven door can be opened again.

Important notes:

- To avoid possible damage to the oven door latch mechanism, do not attempt to open or close the oven door whenever the OVEN LOCK indicator light is flashing.
- If a control key is pressed when the OVEN LOCK is active, **Loc** will appear in the display as a reminder that the oven keys are inactive when the OVEN LOCK feature is active.

Silent or audible control mode



The appliance may be set for silent or audible operation. If the silent mode is selected, most of the sounds associated with setting the controls will be silent. But, sounds will be heard when the timer ends, when a baking function ends, and when the set preheat temperature is reached.

1. Press and hold **Delay Start** until the control beeps once (about 3 seconds). The present mode appears as OFF (silent operation) or ON (for audible operation).
2. Use  or  to toggle between audible or silent modes. To save, press **START** when the desired mode of operation appears in the display.

Changing Temperature Display to Fahrenheit (°F) or Celsius (°C)

The electronic oven control is set to display °F when shipped from the factory. The display may be changed to show either °F or °C oven temperatures.

To change temperature display mode from °F to °C or from °C to °F:

1. Press **Broil**. **HI** appears in the display.
2. Press and hold **Broil** until **F** or **C** appears in the display.
3. Press either  or  to toggle between **F** or **C** mode choices.
4. Press **START** to accept change. The display will return to the time of day.

Important note:

The temperature display mode cannot be changed when the oven is set for cooking.

Add 1 Minute

Use the Add 1 Minute feature to set additional minutes to the timer. Each press of the key will add 1 additional minute. If **Add 1 Minute** is pressed when the timer is not active, the timer will activate and begin counting down from 1 minute.

To add 2 minutes to the timer:

Press **Add 1 Minute** twice.

Oven Controls

Changing between continuous bake setting or 12-hour energy saving feature

The oven control has a factory-preset 12-hour energy saving feature that will turn the oven off automatically if the oven is left on for more than 12 hours. The control may be programmed to override this feature to continuously bake.

To change to continuous bake mode:



Press and hold **Timer ON/OFF** until the control beeps once (about 6 seconds). **Cont** will appear in display. The control is set for continuous bake. Press **Self Clean** to toggle between continuous bake and 12hr energy saving. **12 Hr** will appear in display for energy saving mode.



To save the selected mode, press **START**. The display will return to idle.

Setting Timer

The timer may be set from 1 minute to 11 hours and 59 minutes.

To set the timer:

1. Press **Timer ON/OFF**.
2. Press and hold  to increase the time. Release  when the desired time appears in the display.
3. Press **START**, and the timer will begin to count down.
4. When the set time has run out, the timer will sound with three beeps and will continue to beep three times every 60 seconds until **Timer ON/OFF** is pressed.

To change time remaining in timer, press and hold  or  to increase or decrease any time remaining.

To cancel the timer before at any time, press **Timer ON/Off** once.

Important notes:





- The timer does not start or stop the cooking process. It serves as an extra timer in the kitchen that will beep when the set time has run out. The timer may be used alone or when any other oven function is active.
- The indicator light located above **Timer ON/OFF** will glow when the timer is active.
- The timer will display hours and minutes until 1 hour remains. When less than 1 hour remains, the display will count down in minutes and seconds. Once the timer has less than 1 minute remaining, only seconds will display.
- If the timer is active when oven cooking, the minute timer will show in the display by default. To view information of any other active oven function, press the key once for the active function to view status.

Setting Bake

Use the bake function whenever the recipe calls for baking using normal temperatures. A reminder tone will sound when the set bake temperature is reached. Bake may be programmed for any temperature from 170°F to 550°F (77°C to 288°C). The factory preset bake temperature is 350°F (177°C).



CAUTION Always use pot holders or oven mitts when using the oven. When cooking the oven interior, oven racks and cook-top will become very hot which can cause burns.

To set Bake

1. Arrange oven racks and close oven door.
2. Press **Bake**. **350°** appears in display.
3. Within 15 seconds, press  or . The display will show the default oven temperature of **350°F (177°C)**. By pressing  or , the oven temperature may be adjusted in 5°F increments (1°C).
4. Press **START** when the desired temperature appears. The oven will begin heating to the selected temperature. When the oven temperature reaches the set temperature, the **PRE-HEAT** indicator light will turn off, and the oven control will beep three times.

To cancel bake at anytime, Press .

To change the oven temperature after Bake has started:

1. Press **Bake**. The current set oven temperature will display.
2. Press  or  to increase or decrease the current set temperature to the new oven temperature.

Important notes:

- The oven will bake no longer than 12 hours. If you wish to bake for a longer period, see [“Changing between continuous bake setting or 12-hour energy saving feature”](#) on page 14 mode for detailed information.

Baking tips

- Fully preheat the oven before cooking items like cookies, biscuits, and breads.
- When using any single rack, position the rack so that the food is in the center of the oven.
- For best results when baking cakes or cookies using two oven racks, place racks in positions 3 and 6 (See Figure 8).
- Dark or dull bakeware absorbs more heat than shiny bakeware. It may be necessary to reduce oven temperature and cook time to prevent overbrowning of some foods. Dark bakeware is recommended for pies. Shiny bakeware is recommended for cakes, cookies, and muffins.
- For best results when baking cakes or cookies using two oven racks, place pans as shown in Figure 7.

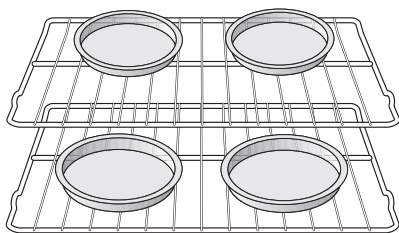

Figure 7: Baking on multiple levels

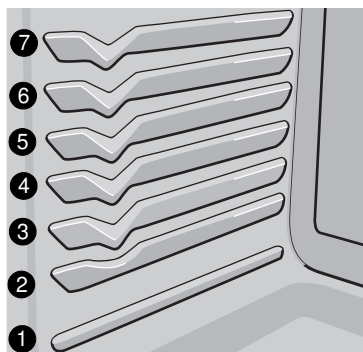









Figure 8: Oven rack positions

Setting Cook Time

Use Cook Time to set the amount of time needed for baking. The oven will turn on immediately and stop automatically after the set cook time ends.



⚠ WARNING Food Poisoning Hazard. Do not let food sit for more than one hour before or after cooking. Doing so can result in food poisoning or sickness. Foods that can easily spoil such as milk, eggs, fish, meat, or poultry should be chilled in the refrigerator first. Even when chilled, they should not stand in the oven for more than 1 hour before cooking begins and should be removed promptly when finished cooking.

To program the oven to begin baking immediately and to shut off automatically:

1. Be sure that the clock displays the correct time of day. Arrange oven racks and close oven door.
2. Press **Bake**. **350°** appears in display.
3. Within 15 seconds, press  or . The display will show the default oven temperature of **350°F (177°C)**. By pressing  or , the temperature may be adjusted in 5°F increments (1°C). Press **START** to accept.
4. Press **Cook Time**. **00** will appear in display.
5. Press  or  to reach the desired cook time.
6. Press **START** to accept. When the oven temperature reaches the set temperature, the PRE HEAT indicator light turns off and the oven control will beep once.
7. To cancel at anytime, press .

When the cook time runs out, **End** will appear in the display. The oven control will beep three times every minute as a reminder until **STOP** is pressed.

To change the oven temperature or cook time after baking has started:

1. Press **Bake** (for oven temperature) or **Cook Time**.
2. To adjust temperature or cook time, press  or  and release when the desired temperature or cook time setting appears in the display.

Important notes:

- Cook Time and Delay Start may be set with Bake but are not available for use with Broil.
- While baking with Cook Time, press **Cook Time** to display any cook time remaining.
- Cook Time and Delay Start can be set with Bake or Convection (on some models).
- The maximum Cook Time or Delay Start setting is 11 hours and 59 minutes.

Oven Controls









Setting Delay Start

Delay Start allows you to set a delayed starting time to the oven baking or cleaning functions.

⚠ WARNING Food Poisoning Hazard. Do not let food sit for more than one hour before or after cooking. Doing so can result in food poisoning or sickness. Foods that can easily spoil such as milk, eggs, fish, meat, or poultry should be chilled in the refrigerator first. Even when chilled, they should not stand in the oven for more than 1 hour before cooking begins and should be removed promptly when finished cooking.



⚠ CAUTION Always use pot holders or oven mitts when using the oven. When cooking the oven interior, oven racks and cook-top will become very hot which can cause burn

To program oven for a delayed starting time and to shut off automatically:

1. Be sure that the clock displays the correct time of day.
2. Arrange oven racks and close oven door.
3. Press **Bake**. **350°** appears in display.
4. Within 15 seconds, press  or . The display will show the default oven temperature of **350°F (177°C)**. By pressing  or , the oven temperature may be adjusted in 5°F increments (1°C). When desired temperature is reached press **START** to accept.
5. Press **Cook Time**. **00** will appear in display.
6. Press the  or  to set the desired cook time. Then press **START** to accept.
7. Press **Delay Start**. The time of day will appear in the display. Press  or  until the desired starting time appears in the display and press **START**.
8. The oven will turn on at the set delayed starting time and begin heating. When the oven temperature reaches the set temperature, the PRE HEAT indicator light will turn off and the oven control will beep three times.

To cancel at anytime, press .

To change the oven temperature or cook time after baking has started:

1. Press **Bake** (for oven temperature) or **Cook Time**.
2. Press  or  and release when the desired temperature or cook time setting appears in the display.

When the cook time runs out, **End** will appear in the display.

The oven control will beep three times every minute until  is pressed.

Convec Bake

Benefits of convection cooking include:

- Foods cook up to 25 to 30% faster, saving time and energy.
- Multiple rack baking.
- No special pans or bakeware needed.



Convection functions use a fan to circulate the oven's heat uniformly and continuously around the oven. This improved heat distribution allows for fast, even cooking and browning results. It also gives better baking results when using two oven racks at the same time.

Heated air flows around the food from all sides, sealing in juices and flavors. Breads and pastry brown more evenly.

Most foods baked in a standard pan will cook faster and more evenly with the convection feature.

Convec Bake may be set for any oven temperature between 170°F (77°C) and 550°F (288°C).

To set Convec. Bake with a default oven set temperature of 350°F:

1. Arrange oven racks and close oven door.
2. Press **Convec Bake. 350** will appear in the display.
3. By pressing  or , the oven temperature may be adjusted in 5°F increments (1°C). When setting for convection, be sure to set the oven temperature between 300°F (149°C) and 550°F (288°C).

To cancel Convec Bake at any time, press .

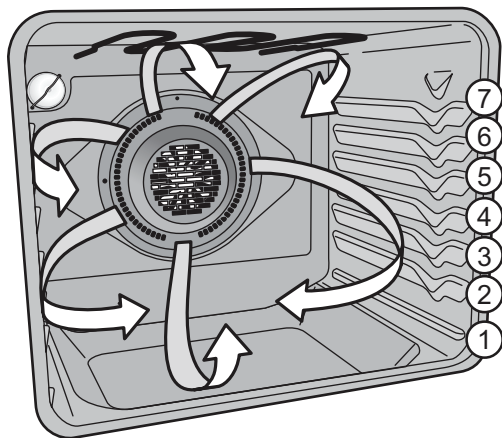

Figure 9: Air movement using convection

Important notes:

- The convection fan will begin rotating once Convec Bake has been activated.
- If the oven door is opened when Convec Bake is active, the convection fan will stop rotating until the oven door is closed.
- When using Convec Bake, cook time reductions may vary depending on the amount and type of food being cooked.

Suggestions for Convec Bake:

- For optimum cooking results, it is recommended to preheat the oven when baking foods such as cookies, biscuits, and breads.
- Reduce oven temperature 25°F from recipe's recommended oven temperature. Follow the remainder of the recipe's instructions using the minimum recommended cook time.
- For best results when using a single oven rack, place rack in position 4 or 5 (See [Figure 9](#)). When using two oven racks, place in positions 2 and 5. When using three oven racks, place in positions 2, 4, and 7 (use offset rack only in position 7).
- Dark or dull pans absorb more heat than shiny bakeware resulting in dark or overbrowning of foods. It may be necessary to reduce the oven temperature or cook time to prevent overbrowning of some foods. Dark pans are recommended for pies. Shiny pans are recommended for cakes, cookies, and muffins.
- When using any single rack, position the rack so that the food is in the center of the oven.
- For best results when baking cakes or cookies using two oven racks, place pans as shown in [Figure 10](#).

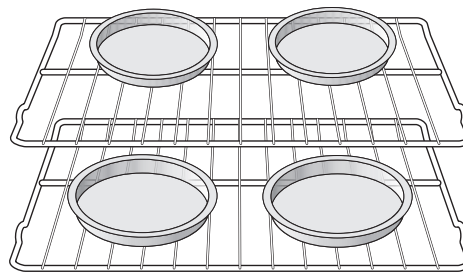

Figure 10: Baking on multiple levels

Oven Controls

Setting Broil

Use the broil function to cook meats that require direct exposure to flame heat for optimum browning results. The Broil function is factory preset to broil, shown as **Hi**. The suggested broil settings are recommendations only. Increase or decrease broiling times or move to a different rack position to suit for doneness.

To set Broil:

1. Arrange the oven racks when cool. For optimum browning results, preheat oven for 2 minutes before adding food.
2. Position cookware in oven. Leave door open at broil stop position.

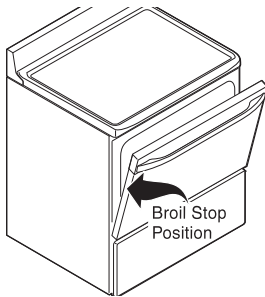

Figure 11: Door open for broiling





3. Press **Broil**. **HI** will appear in display.
4. Press  or  until the desired broil setting level appears in the display. Press  for HI broil or  for LO broil setting.
5. Press **START**. Broil on one side until food is browned. Turn and broil food on other side. When finished broiling, press **STOP**.

Table 3: Suggested Broil Settings¹

Food	Rack Position	Setting	Cook time in minutes		Doneness
			1st side	2nd side	
Steak, 1 inch thick	6th or 7th*	Hi	8	6	Medium
Steak, 1 inch thick	5th or 6th*	Hi	10	8	Medium-well
Steak, 1 inch thick	5th or 6th*	Hi	11	10	Well
Pork Chops, 3/4 inch thick	5th	Hi	12	8	Well
Chicken, bone-in	5th	Lo	25	15	Well
Chicken, boneless	5th	Lo	10	8	Well
Fish	5th	Hi	as directed		Well
Shrimp	4th	Hi	as directed		Well
Hamburger, 1 inch	5th or 6th	Hi	12	10	Medium

1. For steaks, cook times are suggestions and should only be used as a guide.

CAUTION Always use pot holders or oven mitts when using the oven. When cooking, the oven interior, oven racks, and cooktop will become very hot which can cause burns.

WARNING Should an oven fire occur, close the oven door and turn the oven off. If the fire continues, use a fire extinguisher. Do not put water or flour on fire. Flour may be explosive.

Important notes:

- Always arrange oven racks when the oven is cool.
- For best results when broiling, use a broil pan with broil pan insert designed to drain the fat from the food and help avoid spatter and reduce smoking. To purchase them, call Sears at 1-800-4-MY-HOME (1-800-4663) and order broil pan kit 5304442087.
- When broiling, always pull the oven rack out to the stop position before turning or removing food.

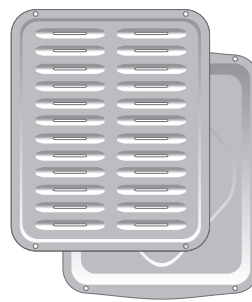

Figure 12: Broiler pan and insert

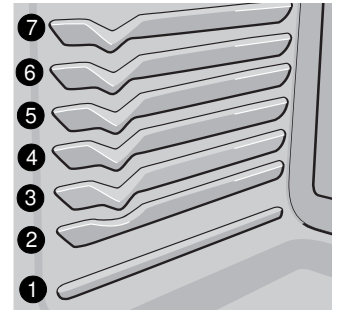



Figure 13: Rack positions

Warm & Hold™





Warm & Hold will keep cooked foods warm and ready for serving for up to 3 hours after cooking has finished. After 3 hours, Warm & Hold will shut off automatically. Warm & Hold should only be used with foods that are already at serving temperatures. Warm & Hold will maintain the oven temperature at 170°F (77°C).

To set Warm & Hold:

1. If needed, arrange oven racks and place cooked food in oven.
2. Press **Warm & Hold**. **Hld** will appear in the display. If no other keys are touched within 25 seconds, the request for Warm & Hold will clear.
3. Press **START**.
4. Warm & Hold will automatically turn off after 3 hours.

To turn Warm & Hold off at any time, press .

To set Warm & Hold to start after a Timed Bake automatically:

1. Press **Bake**. Press  or  to set temperature.
2. Press **START**.
3. Press **Cook Time**. Press  or  to set time.
4. Press **START**.
5. Press **Warm & Hold**.
6. Press **START**. Warm & Hold is set to turn on automatically after the Timed Bake or Delay Timed Bake has finished. The Warm & Hold indicator light will glow indicating that the Warm & Hold feature is set to start when the timed bake is finished.

Operating Oven Light

The oven light will automatically turn on when the oven door is opened.

Press **LIGHT** to turn the oven light on or off whenever the oven door is closed. The oven light will not operate during the self clean operation.

The oven light is located at the upper left rear wall of the oven interior and is covered with a glass shield held in place by a wire holder. The glass shield protects the bulb from high temperatures and should always be in place when the oven is in use.



To replace the interior oven light, see [“Replacing oven light \(some models\)”](#) on page 25.

Adjusting oven temperature



The appliance has been factory calibrated and tested to ensure an accurate baking temperature, known as the User Preference Offset (UPO). For the first few uses, follow your recipe times and temperature recommendations carefully. If you think the oven is cooking too hot or too cool for your recipe times, you may adjust the control so the oven cooks hotter or cooler than the oven temperature displayed.

The oven temperature may be increased as much as +35°F (+19°C) or decreased -35°F (-19°C) from the factory calibrated settings.

To adjust oven temperature:

1. Press **Bake** and hold for 3 seconds. The UPO value will appear in the display with a degree sign.
2. The display now indicates the amount of degrees offset from the original factory temperature setting. If the control still has the original factory calibration, the display will read **0**.
3. The temperature may be adjusted up or down 35°F (19°C), in 1°F increments by pressing and holding  or . Adjust until the desired amount of temperature offset appears in the display and press **START** to save.
4. If the **STOP** key is pressed during the programming mode, the UPO value will remain unchanged.

Important notes:

- Oven temperature adjustments made will not change the Broil or Self-Clean operating temperatures.
- Do not use oven thermometers such as those found in grocery stores to check the temperature settings inside your oven. These oven thermometers may vary as much as 20°F to 40°F degrees from actual temperatures.
- The oven temperature adjustment may be made if your oven control has been set to display °C temperatures. Minimum and maximum settings for °C is plus (+) or minus (-) 19°C.
- If the display mode is set for °C, adjustments made will be in 1°C increments on each press of  or .

Self Clean

A self cleaning oven cleans itself with high temperatures (well above normal cooking temperatures), which eliminate soils completely or reduces them to a fine powdered ash you can wipe away afterwards with a damp cloth.

The Self Clean function allows you to select three different cleaning times from 2, 3, or 4 hours. A 3-hour cleaning time is best used for normal cleaning; 2-hour time for light soils, and a 4-hour clean time for heavier stubborn soils.

Read before starting Self Clean. Be sure to read all following caution and important statements before starting a self clean cycle.

⚠ CAUTION Do not leave small children unattended near appliance. During self clean cycle, the outside of the oven can become very hot and cause burns if touched.

⚠ CAUTION Do not line the oven walls, racks, oven bottom, or any part of the range with aluminum foil. This will cause permanent damage to the oven interior and destroy heat distribution, and will melt to the oven interior.

⚠ CAUTION Do not force the oven door open. This will damage the automatic door locking system. Use caution when opening the oven door after the self clean cycle ends. The oven may still be very hot and cause burns. To avoid possible burns, stand to side of oven when opening door to allow steam or hot air to escape.

⚠ CAUTION The health of some birds is extremely sensitive to fumes given off during the self clean cycle of any range. Move birds to a well ventilated room.

⚠ CAUTION Radiant surface elements will operate when an oven is in Self Clean mode IF the range is equipped with knobs. If this is the case, it is NOT advisable to use the surface elements when using the Self Clean function. The oven reaches very high temperatures and you could be burned.

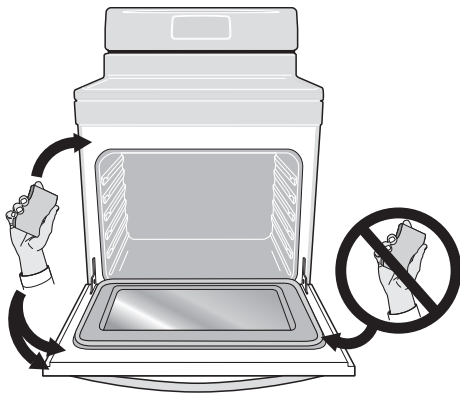



Figure 14: Areas to clean and to avoid

Important notes:

- Completely remove all oven racks and any accessories from oven cavity to avoid damage to oven racks. If the oven racks are not removed they may discolor. Remove all items from the oven and cooktop including cookware, utensils and any aluminum foil. Aluminum foil will not withstand high temperatures from a self clean cycle and will melt.
- Do not use oven cleaners or oven protective coatings in or around any part of the oven interior. Clean any soil from the oven frame, the door liner outside the oven door gasket, and the small area at the front center of the oven bottom (See Figure 14). These areas heat sufficiently to burn soil on. Clean using soap and water prior to starting Self Clean.
- Remove any excessive spills. Any spills on the oven bottom should be wiped up and removed before starting a Self Clean cycle. To clean use hot, soapy water and a cloth. Large spills can cause heavy smoke or fire when subjected to high temperatures. Do not allow food spills with high sugar or acid content (such as milk, tomatoes, sauerkraut, fruit juices, or pie fillings) to remain on the surface as they may leave a dull spot even after cleaning.
- Do not clean the oven door gasket. The woven material in the gasket is essential for a good seal. Care should be taken not to rub, damage, or remove the oven door gasket. Doing so could cause damage to the door gasket and compromise the performance of the oven.
- The kitchen area should be well ventilated using an open window, ventilation fan, or exhaust hood during the first Self Clean cycle. This will help eliminate the normal odors.
- Do not attempt to open the oven door when the OVEN LOCK indicator light is flashing. Allow about 15 seconds for the motorized door latch mechanism to completely lock or unlock the oven door.
- When the clean time finishes, the oven door will remain locked until the range has cooled sufficiently. In addition to the clean time that was programmed, you must allow about 1 additional hour for the oven to cool before you will be able to open the oven door.
- This model comes with lubricated porcelain oven racks, which can remain in the oven during the self-clean cycle. Do not clean this vegetable oil lubrication off the racks. It is important that the sides of the oven racks always have a light coating of vegetable oil. To maintain optimal rack performance, re-apply a thin layer of vegetable oil to the sides of the rack after every self-clean cycle or when the rack becomes difficult to slide.

Setting Self Clean

To set Select Clean to start immediately:

1. Be sure the oven is empty and all oven racks are removed. Remove all items from the cooktop. Be sure the oven door is completely closed.
2. Press **Self Clean**. **3:00** appears in the display.
3. To change to a 2 hour clean time, press . **2:00** appears in the display. To select a 4 hour clean time, press . **4:00** appears in the display.
4. After selecting the clean time, press **START** to activate Self Clean. The **OVEN LOCK** indicator light will light, and **CLn** will appear in the display.

When Self Clean begins the cleaning cycle, the motorized door latch mechanism will automatically start to lock the oven door, and the **OVEN LOCK** indicator light will flash. Do not open the oven door when the **OVEN LOCK** indicator light is flashing. Allow about 15 seconds for the oven door to completely lock.

Once the oven door has locked, the **OVEN LOCK** indicator light will glow steady. When **CLn** will appear in the display, Self Clean is active.



When Self Clean is finished:

⚠ CAUTION Use caution when opening the oven door after self cleaning. The oven may still be very hot and can cause burns. To avoid possible burns, stand to the side of the oven when opening the oven door to allow hot air or steam to escape.

1. The time of day will appear in the display window, and the **OVEN LOCK** indicator light will continue to glow.
2. Once the oven has cooled down (about 1 hour) and the **OVEN LOCK** indicator light has turned off, the oven door may be opened.
3. When the oven interior has completely cooled, wipe away any residue or powdered ash with a damp cloth or paper towel.

Delayed Start Self Clean

To start Delay Start Self Clean:

1. Be sure the oven is empty and all oven racks are removed. Remove all items from the cooktop. Be sure oven door is completely closed.
2. Be sure the clock shows the correct time of day.
3. Press **Delay Start**.
4. Press and hold  to scroll to the time desired to start the self clean cycle. Press **START** when the desired start time is displayed.
5. Press **Self Clean**. **3:00** appears in the display.
6. To select a 2 hour clean time, press . **2:00** appears in the display. To select a 4 hour clean time, press . **4:00** appears in the display.
7. After selecting the desired clean time, press **START**. Self Clean is set to activate. The **OVEN LOCK** indicator light will turn on, and the oven door will lock in advance of the starting time. Once the starting time is reached, **CLn** will appear in the display.

If it becomes necessary to stop Self Clean when active:

1. Press .
2. If Self Clean has heated the oven to a high temperature, allow enough time for the oven to cool and for the **OVEN LOCK** indicator light to turn off. When this indicator light turns off, the oven door may be opened.
3. Restart Self Clean, if needed.

Important notes:

- If Self Clean is active and a power failure occurs, the oven may not have thoroughly cleaned. This would depend on how much cleaning time had elapsed before the power failure. If needed after power is restored, set Self Clean again.

Oven Controls

Steam Clean

Steam cleaning works best for spot cleaning and light soils on the oven bottom. Steam clean may also be used before manually cleaning the oven or before Self Clean to help loosen soils on the oven bottom.

⚠ WARNING Do not set the cleaning temperature higher than the temperature listed in these instructions. Higher temperatures will dry the steam too soon and may lead to burns or serious injury when cleaning.

⚠ WARNING Do not attempt to wipe out the oven before the cooling off period or attempt to shorten the cooling off period. Doing so may lead to burns or other serious injury when cleaning.

⚠ CAUTION Do not add ammonia, oven cleaners, or any other household cleaners or chemicals to the water used for steam cleaning.

To set the controls for steam clean:

1. Oven should be at room temperature. Remove all racks and oven accessories.
2. Scrape or wipe loose debris from the oven bottom.
3. Pour 8 oz (235 ml) of distilled or filtered water onto the oven bottom (See [Figure 15](#)). Close the oven door.

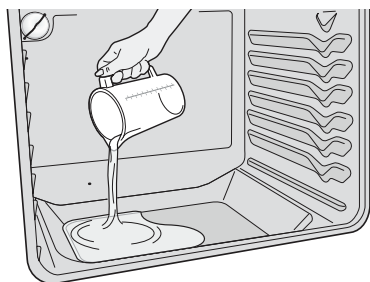



Figure 15: Pour water onto the oven bottom

4. Press **Bake**.
5. Enter **170°F (77°C)** using the arrow keys and press **START**.
6. Set the minute timer for **10** minutes.
7. Allow the oven to heat. Do not open the oven door while the oven is heating.
8. An alert will sound when the timer is finished. Press **Timer ON/Off** to stop the timer and press  to return to the clock.
9. Set the minute timer for **10** minutes to allow for a cool-down period. Do not attempt to wipe out the oven before a 10 minute cool-down period.
10. An alert will sound when the timer is finished. Press **Timer ON/Off** to stop the timer.

11. Stand to the side of the range out of the way of escaping vapor when opening the oven door.
12. Wipe oven cavity and bottom. Do not clean oven door gasket (See [Figure 16](#)).

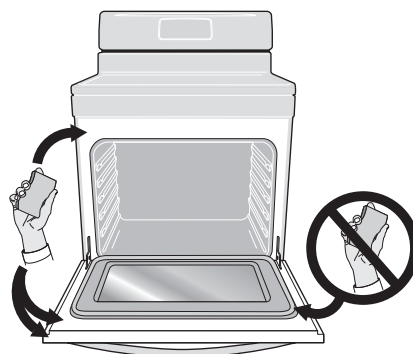



Figure 16: Do not clean the oven door gasket

To stop the steam cleaning cycle at any time, press .

Important notes:

- Always stay close to the oven when steam cleaning, so you can hear the timer alert.
- For best results, wipe out oven immediately after the cool-down period is complete.
- Removal of especially stubborn or baked-on soils may require a manual cleaning or a self clean cycle. See instructions in the “Self Clean” section on [page 20](#).
- Some condensation or water vapor may appear close to the oven vent, and some water may remain on the oven bottom. This is normal. Wipe with a soft cloth or sponge when the cool-down period is complete.
- The oven gasket may become damp; do not wipe dry. Open door to broil position and allow to air dry.
- Local water sources often contain minerals (hard water) and will leave deposits on the oven cavity surfaces. If this occurs, wipe cavity surfaces with diluted vinegar or lemon juice. Use distilled or filtered water.
- If the door is opened during steam cleaning or cool-down period, steam will escape and the oven may be more difficult to clean. Keep oven door closed during steam cleaning.

Care & Cleaning

Table 4: Cleaning recommendations

Surface Type	Recommendation
Control knobs Painted body parts Painted decorative trim Aluminum, plastic or vinyl trim	For general cleaning, use hot, soapy water and a cloth. For more difficult soils and built-up grease, apply a liquid detergent directly onto the soil. Leave on soil for 30-60 minutes. Rinse with a damp cloth and dry. Do not use abrasive cleaners on any of these materials; they can scratch. To remove control knobs, turn to OFF position. Grasp firmly and pull straight off the shaft. To replace knobs after cleaning, line up the flat sides of both knob and shaft, then push knob into place.
Control panel Control keypad membrane Decorative trim (some models)	Before cleaning the control panel, turn all controls off, activate oven lockout (on some models), and if needed remove any knobs from panel. Do not use abrasive cleaners on any of these materials; they can scratch. Clean using hot, soapy water and a cloth or sponge. Be sure to squeeze excess water from cloth or sponge before wiping control panel, especially when wiping around the controls area. Excess water in or around the controls may cause damage to the appliance. When rinsing, use clean water and a cloth or sponge and be sure to squeeze excess water from cloth or sponge before wiping the control panel.
Porcelain enamel parts and door liner	Gentle scrubbing with a soapy non-abrasive scouring pad will remove most spots. Rinse with a 1:1 solution of clear water and ammonia. If necessary, cover difficult spots with an ammonia-soaked paper towel for 30 to 40 minutes. Rinse with clean water and a damp cloth, and then scrub with a soap-filled non-abrasive scouring pad. Rinse and wipe dry with a clean cloth. Do not allow food spills with high sugar or acid content (milk, tomatoes, sauerkraut, fruit juices, or pie filling) to remain on the surface; they may cause a dull spot even after cleaning.
Oven interior	For oven interior remove excessive spillovers from oven cavity bottom before starting Self Clean. Clean any soils from oven frame and door liner outside the oven door gasket. For very important cleaning precautions be sure to read all the instructions in the "Self Clean" section of the Oven Controls chapter on page 20 .
Porcelain coated oven racks	This model comes with lubricated porcelain oven racks, which can remain in the oven during the self-clean cycle. Do not clean this vegetable oil lubrication off the racks. It is important that the sides of the oven racks always have a light coating of vegetable oil. To maintain optimal rack performance, re-apply a thin layer of vegetable oil to the sides of the rack after every self-clean cycle or when the rack becomes difficult to slide.
Oven door	Use soap and water to thoroughly clean the top, sides, and front of the oven door. Rinse well. You may use a glass cleaner on the outside glass of the oven door. Do not immerse the door in water. Do not spray or allow water or the glass cleaner to enter the door vents. Do not use oven cleaners, cleaning powders, or any harsh abrasive cleaning materials on the outside of the oven door.
Surface elements and drip bowls	Do not use spray oven cleaners on the cooktop. See " Surface elements and drip bowls " on page 24 .
Stainless Steel (some models)	Only use cleaners and polishes that are specifically manufactured for cleaning stainless steel. Always rub in direction of metal grain to avoid damaging. Do not use cleaners with high concentrations of chlorides or chlorine. Do not use harsh scrubbing cleaners. Polish with a lint-free cloth. Always be sure to wipe excess cleaner/polish off from the metal surface as bluish stains may occur during future oven heating that cannot be removed. Clean heavier soils with hot, soapy water and a cloth or sponge. Rinse and dry using clean water and a cloth.



General Cleaning

Refer to [Table 4](#) in this chapter for more detailed information about cleaning specific parts of the range.

CAUTION Before manually cleaning any part of the range, be sure all controls are turned off and the range is cool. The range may be hot and can cause burns.

CAUTION Ammonia must be rinsed before operating the oven. Provide adequate ventilation.

Aluminum foil and utensils

WARNING Never cover any slots, holes, or passages in the oven bottom or cover an entire oven rack with materials such as aluminum foil. Aluminum foil linings may trap heat, causing a fire hazard.

WARNING Protective Liners — Do not use aluminum foil to line the oven bottom. Only use aluminum foil as recommended in this manual. Improper installation of these liners may result in risk of electric shock, or fire.

- Aluminum foil - Use of aluminum foil on a hot cooktop can damage the cooktop. Do not use thin aluminum cooking utensils or allow aluminum foil to touch the surface elements under any circumstances.
- Aluminum utensils - The melting point of aluminum is much lower than that of other metals. Care must be taken when aluminum pots or pans are used on the cooktop. If aluminum pans are allowed to boil dry when using the cooktop, not only will the utensil be damaged or destroyed, but it may fuse to, break, or mark the ceramic glass surface, permanently damaging the cooktop surface.

Surface elements and drip bowls

To remove the surface elements and drip bowls:

CAUTION Surface elements may appear to have cooled after they have been turned off. The surface elements may still be hot and burns may occur if touched before they have cooled sufficiently.

CAUTION Protective liners — Do not use aluminum foil to line surface drip bowls or reflector pans. Only use aluminum foil as recommended in this manual. Improper installation of these liners may result in risk of electric shock or fire.

Surface elements may be unplugged and removed to make cleaning the drip pans easier. The surface elements clean themselves when they are turned on. Food spilled on a hot element will burn off. Food spilled on a cool element may be cleaned with a damp cloth. Any remaining soil will burn off the next time the element is used.

1. Lift the edge of the drip bowl across from the terminal end. Lift the surface element and drip bowl together just enough to clear the cooktop.
2. While holding the drip bowl and surface element, gently pull the terminal end out from terminal plug (See [Figure 17](#)).

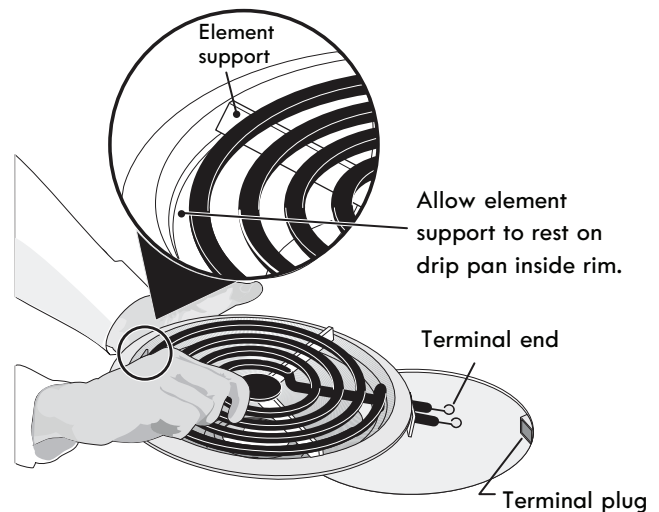

Figure 17: Removing surface elements and drip bowls

Cleaning drip bowls

Wash in hot, soapy water or in the dishwasher. Rinse and dry while still warm. Hard to remove, burned on soil can be removed by soaking the drip bowls for about 20 minutes in a lightly diluted liquid cleanser or a solution of ammonia and water (1/2 cup ammonia to 1 gallon of water). A non-abrasive scouring pad may be used after soaking. Do not use abrasive cleaners or steel wool. They will scratch the surface. Always rinse with clean water and polish dry with a soft cloth.

To replace drip bowls and surface elements:

1. Slide the terminal end on the surface element through the opening in the drip bowl (See [Figure 17](#)).
2. Align the surface element support to rest on the rim inside the drip bowl.
3. After the surface element is positioned in the drip bowl, line up the terminal end with the terminal plug as shown (See [Figure 17](#)).
4. Hold the surface element and drip bowl together as level as possible and firmly push the terminal end into the terminal plug. Make sure element terminal is seated properly into terminal plug. Make sure the surface element is level to reduce the hazard of cookware sliding off the element.

Important note:

- Be sure the range is cool before removing surface elements or drip bowls. Never immerse a surface element in water. Make sure drip bowls are in place - Absence of these bowls during cooking may subject wiring or components underneath to damage. Be careful not to bend terminal ends when replacing surface elements after cleaning.

Raising and lowering the cooktop (some models)

⚠ WARNING To avoid possible burns, do not turn the surface elements on when the cooktop is raised. Be sure that the top is completely lowered and securely in place before turning on any of the surface burners.

⚠ CAUTION When lowering the lift-up range cooktop, grasp the sides with fingertips only. Be careful not to pinch fingers. Do not drop or bend the cooktop when raising or lowering. This may permanently damage the cooktop surface.

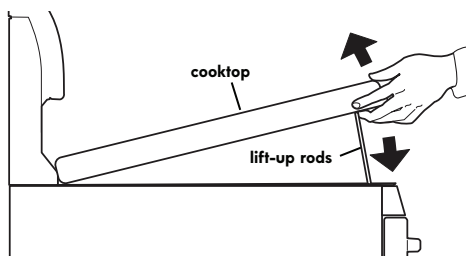

Figure 18: Raising and lowering the cooktop

To raise and lower the cooktop:

1. Remove all items from cooktop and set aside.
2. Grasp the sides of the cooktop and then lift from the front (See [Figure 18](#)).
3. Lift the cooktop high enough to allow the support rods to snap into place. The lift-up rods will support the cooktop in the raised position.
4. If necessary, clean underneath using hot, soapy water and a clean cloth; then dry.
5. To lower the cooktop, grasp the front corner of each side of the top while pushing back on each rod with the heel of your hand. This will release the notched support. Hold the range cooktop and gently slide the top back down level to the range.

Replacing oven light (some models)

To replace the interior oven light bulb:

⚠ CAUTION Be sure the range is unplugged and all parts are cool before replacing oven light. Wear a leather-faced glove for protection against possible broken glass.

The oven light is located at the rear of the oven cavity and is covered with a glass shield held by a wire holder. The glass shield protects the light bulb and must be in place whenever the oven is in use.

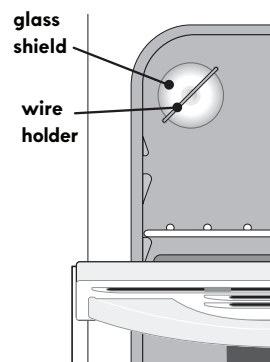

Figure 19: Replacing the oven light

1. Turn electrical power off at the main source or unplug the range.
2. Press wire holder to one side to release the glass shield that covers the light bulb.
3. Replace light with a new 40 watt appliance bulb.
4. Replace glass shield over bulb and snap wire holder back into place.
5. Turn power on at the main source (or plug the appliance in).
6. The clock will then need to be reset. To reset, see [“Setting Clock”](#) on [page 13](#).

Care & Cleaning

Removing and replacing the lift-off oven door

⚠ CAUTION To avoid possible injury when removing or replacing the oven door, follow the instructions below carefully and always hold the oven door with both hands positioned away from the door hinge area.

⚠ CAUTION The door is heavy. For safe, temporary storage, lay the door flat with the inside of the door facing down.

To remove the oven door:

1. Open oven door completely (horizontal with floor - [Figure 20](#)).
2. Pull the door hinge locks on both left and right door hinges down from the oven frame completely towards the oven door ([Figure 21](#)). A tool such as a small flat-blade screwdriver may be required.
3. Firmly grasp both sides of oven door along the door sides (Do not use the oven door handle - [Figure 22](#)).
4. Close the door to the broil stop position (the oven door will stop into this position just before fully closing).
5. With the oven door in the broil stop position, lift the oven door hinge arms over the roller pins located on each side of the oven frame ([Figure 22](#)).

To replace oven door:

1. Firmly grasp both sides of oven door along the door sides (Do not use the oven door handle - [Figure 22](#)).
2. Holding the oven door at the same angle as the removal position, seat the hook of the hinge arm over the roller pins located on each side of the oven door frame ([Figure 23](#)). The hook of the hinge arms must be fully seated onto the roller pins.
3. Fully open the oven door (horizontal with floor - [Figure 20](#)).
4. Push the door hinge locks up towards and into the oven frame on both left and right oven door hinges ([Figure 21](#)) to the locked position; then, close the oven door.

Special care instructions

Most oven doors contain glass that can break. Follow these recommendations:

- Do not close the oven door until all the oven racks are fully in place inside the oven cavity.
- Do not hit the glass with pots, pans, or any other object.
- Scratching, hitting, jarring, or stressing the glass may weaken its structure causing an increased risk of breakage at a later time.

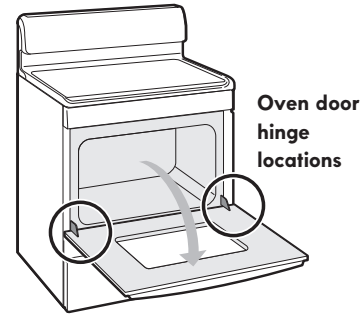

Figure 20: Oven hinge locations

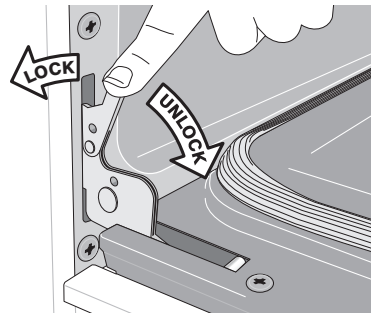

Figure 21: Hinge lock/unlock positions

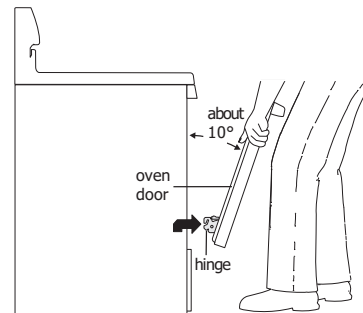

Figure 22: How to remove door

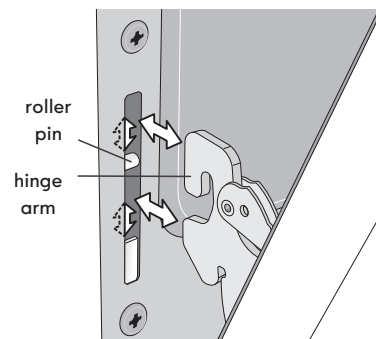

Figure 23: Hinge pin locations





Before You Call

Oven Baking

For best cooking results, heat the oven before baking cookies, breads, cakes, pies, pastries, et cetera. There is no need to preheat the oven for roasting meat or baking casseroles.

The cooking times and temperatures needed to bake a product may vary slightly from your previously owned appliance.

Baking Problems and Solutions

Baking Problems	Causes	Corrections
<p>Cookies and biscuits burn on the bottom.</p> 	<ul style="list-style-type: none"> • Cookies and biscuits put into oven before the preheating time is completed. • Oven rack is overcrowded. • Dark pans absorb heat too fast. 	<ul style="list-style-type: none"> • Allow oven to preheat to desired temperature before placing food in oven. • Choose pan sizes that will permit 2" to 4" of air space (5.1 cm or 10.2 cm) on all sides when placed in the oven. • Use a medium weight baking sheet.
<p>Cakes too dark on top or bottom</p> 	<ul style="list-style-type: none"> • Cakes put in oven before preheating time is completed. • Rack position too high or too low. • Oven too hot. 	<ul style="list-style-type: none"> • Allow oven to preheat to the selected temperature before placing food in the oven. • Use proper rack position for baking needs. • Set oven temperature 25°F (13°C) lower than recommended.
<p>Cakes not done in center</p> 	<ul style="list-style-type: none"> • Oven too hot. • Incorrect pan size. • Pan not centered in oven. 	<ul style="list-style-type: none"> • Set oven temperature 25°F (13°C) lower than recommended. • Use pan size suggested in recipe. • Use proper rack position and place pan so there is 5.1 cm to 10.2 cm (2" to 4") of space on all sides of pan.
<p>Cakes not level.</p> 	<ul style="list-style-type: none"> • Oven not level. • Pan too close to oven wall or rack overcrowded. • Pan warped. 	<ul style="list-style-type: none"> • Place a marked glass measuring cup filled with water on the center of the oven rack. If the water level is uneven, refer to the installation instructions for leveling the oven. • Be sure to allow 5.1 cm to 10.2 cm (2" to 4") of clearance on all sides of each pan in the oven. • Do not use pans that are dented or warped.
<p>Foods not done when cooking time is over.</p> 	<ul style="list-style-type: none"> • Oven too cool. • Oven overcrowded. • Oven door opened too frequently. 	<ul style="list-style-type: none"> • Set oven temperature 25°F (13°C) higher than suggested and bake for the recommended time. • Be sure to remove all pans from the oven except the ones to be used for baking. • Open oven door only after shortest recommended baking time.

Solutions to Common Problems

Before you call for service, review the following list. It may save you time and expense. Possible solutions are provided with the problem listed:

Problem	Solution
Poor baking results	<ul style="list-style-type: none">• Many factors affect baking results. Make sure the proper oven rack position is used. Center food in the oven and space pans to allow air to circulate. Allow the oven to preheat to the set temperature before placing food in the oven. Try adjusting the recipe's recommended temperature or baking time. If you feel the oven is too hot or cool, see "Adjusting oven temperature" on page 19.
Appliance is not level.	<ul style="list-style-type: none">• Be sure floor is level, strong, and stable enough to adequately support range.• If floor is sagging or sloping, contact a carpenter to correct the situation.• Poor installation. Place oven rack in center of oven. Place a level on the oven rack. Adjust leveling legs at base of appliance until the rack is level.• Kitchen cabinet alignment may make range appear not level. Be sure cabinets are square and have sufficient room for appliance clearance.
Cannot move appliance easily. Appliance must be accessible for service.	<ul style="list-style-type: none">• Cabinets not square or are built in too tightly. Contact builder or installer to make appliance accessible.• Carpet interferes with appliance. Provide sufficient space so appliance can be lifted over carpet.
Entire appliance does not operate.	<ul style="list-style-type: none">• Make sure power cord is plugged properly into outlet.• Electrical power outage. Check house lights to be sure. Call your local electric company for service outage information.• Service wiring is not complete. Call 1-800-4-MY-HOME® for assistance (See back cover).
Oven portion of appliance does not operate.	<ul style="list-style-type: none">• The time of day is not set. The time of day must first be set in order to operate the oven. See "Setting Clock" on page 13.• Be sure the oven controls are set properly for the desired function. See the "Oven Controls" chapter starting on page 12 and review instructions for the desired cooking function in this manual or see "Entire appliance does not operate" in this checklist.
Surface element is too hot or not hot enough.	<ul style="list-style-type: none">• Incorrect surface control setting. Adjust power level setting.
Surface element does not heat or does not heat evenly.	<ul style="list-style-type: none">• Be sure the correct surface control knob is turned on for element needed.• Lightweight or warped pans used. Use only flat, evenly balanced, medium or heavy-weight cookware. Flat pans heat better than warped pans. Cookware materials and weight of the material affect heating. Heavy and medium-weight pans heat evenly. Because lightweight pans heat unevenly, foods may burn easily.
Oven light does not work.	<ul style="list-style-type: none">• Be sure the oven light is secure in the socket. Also see "Replacing oven light (some models)" on page 25.



Oven smokes excessively when broiling.	<ul style="list-style-type: none"> • Incorrect setting. Follow the “Setting Broil” instructions in Oven Controls chapter on page 18. • Be sure oven door is opened to broil stop position when broiling. • Meat too close to the broil element. Reposition the broil rack to provide proper clearance between the meat and the element. Preheat the broil element for searing. • Meat not properly prepared. Remove excess fat from meat. Cut remaining fatty edges to prevent curling, but do not cut into lean. • Grease has built up on oven surfaces. Regular cleaning is necessary when broiling frequently. Old grease or food spatters cause excessive smoking.
Flames inside oven or smoking from oven vent.	<ul style="list-style-type: none"> • Excessive spillovers in oven. For example, this will happen for pie spillovers or large amounts of grease left on the oven bottom. Wipe up excessive spillovers before starting oven. If flames or excessive smoke are present, follow the “Setting Broil” instructions in Oven Controls chapter on page 18.
Oven control panel beeps and displays any F code error.	<ul style="list-style-type: none"> • Oven control has detected a fault or error condition. Press STOP to clear the error code. Try Bake or Broil function. If the F code error repeats, remove power from appliance, wait 5 minutes, and then repower appliance and set clock with the correct time of day. Try Bake or Broil function again. If the fault recurs, press STOP to clear and call 1-800-4-MY-HOME® for assistance (See back cover).
Self Clean does not work.	<ul style="list-style-type: none"> • Oven control not set properly. Review the “Self Clean” instructions in Oven Controls chapter on page 20.
Soil not completely removed after Self Clean.	<ul style="list-style-type: none"> • Self Clean was interrupted. Review the “Self Clean” instructions in Oven Controls chapter on page 20. • Excessive spillovers on oven bottom. Remove before starting Self Clean. • Failure to clean soil from the oven frame, the door liner outside the oven door gasket and the small area at the front center of the oven bottom. These areas are not in the self-cleaning area, but get hot enough to burn on residue. Clean these areas before the self-cleaning cycle is started. Burned-on residue can be cleaned with a stiff nylon brush and water or a nylon scrubber. Be careful not to damage the oven gasket.
Oven racks discolored.	<ul style="list-style-type: none"> • Oven racks left in oven cavity during Self Clean. Always remove oven racks from oven cavity before starting a self-clean cycle. Clean by using a mild, abrasive cleaner following manufacturer's instructions. Rinse with clean water, dry and replace in oven.
Drip bowls are pitting or rusting.	<ul style="list-style-type: none"> • Foods with acids, such as tomatoes, if allowed to stand in/on bowls will cause corrosion. Remove and wash drip bowls as soon as possible after a spill over. • Normal environment. Along coastal areas, houses are exposed to high salt content in air. Protect bowls as much as possible from direct exposure to air with high salt content.
Drip bowls are turning color or distorted.	<ul style="list-style-type: none"> • Bottom surface of cookware extends beyond surface element and touches cooktop surface. This can cause high enough temperatures to discolor the drip bowls. Do not use cookware of this type. Pan sizes should be matched to the size of the element. Replacement drip bowls may be purchased from your appliance dealer.

Before You Call

Master Protection Agreements

Congratulations on making a smart purchase. Your new Kenmore® product is designed and manufactured for years of dependable operation. But like all products, it may require preventive maintenance or repair from time to time. That's when having a Master Protection Agreement can save you money and aggravation.

The Master Protection Agreement also helps extend the life of your new product. Here's what the Agreement* includes:

- ☑ **Parts and labor** needed to help keep products operating properly **under normal use**, not just defects. Our coverage goes **well beyond the product warranty**. No deductibles, no functional failure excluded from coverage – **real protection**.
- ☑ **Expert service** by a force of more than **10,000 authorized Sears service technicians**, which means someone you can trust will be working on your product.
- ☑ **Unlimited service calls and nationwide service**, as often as you want us, whenever you want us.
- ☑ **“No-lemon” guarantee** – replacement of your covered product if four or more product failures occur within twelve months.
- ☑ **Product replacement** if your covered product can't be fixed.
- ☑ **Annual Preventive Maintenance Check** at your request – no extra charge.
- ☑ **Fast help by phone** – we call it **Rapid Resolution** – phone support from a Sears representative on all products. Think of us as a “talking owner’s manual”.
- ☑ **Power surge protection** against electrical damage due to power fluctuations.
- ☑ **\$250 Food Loss Protection** annually for any food spoilage that is the result of mechanical failure of any covered refrigerator or freezer.
- ☑ **Rental reimbursement** if repair of your covered product takes longer than promised.
- ☑ **25% discount** off the regular price of any non-covered repair service and related installed parts.

Once you purchase the Agreement, a simple phone call is all that it takes for you to schedule service. You can call anytime day or night, or schedule a service appointment online.

The Master Protection Agreement is a risk free purchase. If you cancel for any reason during the product warranty period, we will provide a full refund. Or, a prorated refund anytime after the product warranty period expires. Purchase your Master Protection Agreement today!

Some limitations and exclusions apply. For prices and additional information in the U.S.A. call 1-800-827-6655.

*** Coverage in Canada varies on some items. For full details call Sears Canada at 1-800-361-6665.**

Sears Installation Service

For Sears professional installation of home appliances, garage door openers, water heaters, and other major home items, in the U.S.A. or Canada call **1-800-4-MY-HOME®**.

Contrats de protection principaux

Félicitations! Vous avez fait un bon achat. Votre nouvel appareil Kenmore® est conçu et fabriqué dans le but de vous offrir plusieurs années d'utilisation sans tracas. Cependant, comme tout appareil, il peut nécessiter un entretien préventif ou des réparations occasionnelles. C'est pourquoi un contrat de protection principal peut vous permettre d'épargner de l'argent et vous éviter des problèmes.

Le contrat de protection principal contribue également à prolonger la durée de vie de votre nouvel appareil. Voici ce que couvre le contrat* :

- ☑ **Les pièces et la main-d'oeuvre** requises pour le fonctionnement adéquat de l'appareil **dans des conditions d'utilisation normales**, pas seulement pour les défauts. Notre couverture vous offre **beaucoup plus que la simple garantie du produit**. Aucune franchise, aucune exclusion de défaillance fonctionnelle, **une véritable protection**.
- ☑ **Un service professionnel** offert par une équipe de plus de **10 000 techniciens de service Sears autorisés**, ce qui signifie que votre appareil sera confié à une personne de confiance.
- ☑ **Des appels de service illimités et un service à la grandeur du pays**, à tout moment, aussi souvent que vous le désirez.
- ☑ **La garantie « anti-citron »**, vous assurant le remplacement de l'appareil couvert si quatre défaillances ou plus surviennent à l'intérieur de douze mois.
- ☑ **Le remplacement de l'appareil** couvert s'il ne peut être réparé.
- ☑ **Une vérification d'entretien préventive annuelle** sur demande et sans frais.
- ☑ **Un service d'aide téléphonique rapide**, appelé « **Résolution rapide** », qui vous permet de bénéficier du soutien téléphonique d'un représentant Sears pour tous les produits. Nous sommes votre « guide d'utilisation parlant ».
- ☑ **Une protection contre les surtensions** pour les dommages électriques causés par des fluctuations électriques.
- ☑ **Une couverture annuelle de 250 \$ pour la perte d'aliments** à la suite de toute détérioration d'aliments résultant d'une défaillance mécanique d'un réfrigérateur ou d'un congélateur couvert.
- ☑ **Le remboursement de la location**, si la réparation de l'appareil couvert prend plus de temps que prévu.
- ☑ **Un rabais de 10 %** sur le prix régulier de tout service de réparation non couvert et les pièces installées qui en découlent.

Une fois le contrat acheté, un simple appel téléphonique suffit pour obtenir un service de réparation. Vous pouvez téléphoner à toute heure du jour ou de la nuit, ou prendre rendez-vous en ligne pour une réparation.

Le contrat de protection principal est un achat sans risque. Si, pour quelque raison que ce soit, vous annulez le contrat durant la période de garantie du produit, vous serez remboursé en totalité. En cas d'annulation après la période de garantie du produit, vous recevrez un remboursement calculé au prorata. Procurez-vous votre contrat de protection principal dès aujourd'hui!

Certaines restrictions et exclusions s'appliquent. Si vous êtes aux États-Unis et que vous désirez connaître les prix et obtenir de plus amples renseignements, téléphonez au 1 800 827-6655.

*** Au Canada, la couverture de certains articles peut varier. Pour connaître tous les détails, communiquez avec Sears Canada au 1 800 361-6665.**

Service d'installation Sears

Pour bénéficier du *service d'installation professionnel de Sears* pour électroménagers, ouvre-portes de garage, chauffe-eau et autres appareils domestiques importants, aux États-Unis et au Canada, téléphonez au **1 800 4-MY-HOME**.

Get it fixed, at your home or ours!

Your Home

For troubleshooting, product manuals and expert advice:



www.managemylife.com

For repair – **in your home** – of **all** major brand appliances, lawn and garden equipment, or heating and cooling systems, **no matter who made it, no matter who sold it!**

For the replacement parts, accessories and owner's manuals that you need to do-it-yourself.

For Sears professional installation of home appliances and items like garage door openers and water heaters.

1-800-4-MY-HOME[®] (1-800-469-4663)

Call anytime, day or night (U.S.A. and Canada)

www.sears.com www.sears.ca

Our Home

For repair of carry-in items like vacuums, lawn equipment, and electronics, call anytime for the location of your nearest

Sears Parts & Repair Service Center

1-800-488-1222 (U.S.A.) **1-800-469-4663** (Canada)

www.sears.com www.sears.ca

To purchase a protection agreement on a product serviced by Sears:

1-800-827-6655 (U.S.A.) **1-800-361-6665** (Canada)

Para pedir servicio de reparación a domicilio, y para ordenar piezas:

1-888-SU-HOGAR[®]

(1-888-784-6427)

www.sears.com

Au Canada pour service en français:

1-800-LE-FOYER^{MC}

(1-800-533-6937)

www.sears.ca

sears

® Registered Trademark / TM Trademark of KCD IP, LLC in the United States, or Sears Brands, LLC in other countries

© Marca Registrada / TM Marca de Fábrica de KCD IP, LLC en Estados Unidos, o Sears Brands, LLC in otros países

^{MC} Marque de commerce / ^{MD} Marque déposée de Sears Brands, LLC