



OWNER'S MANUAL

*Operating and Servicing
Instructions*

www.hoover.com

FLOORMATE

FH40150 Series

FLOORMATE DELUXE

FH40160 Series

FH40165 Series

FH40170 Series

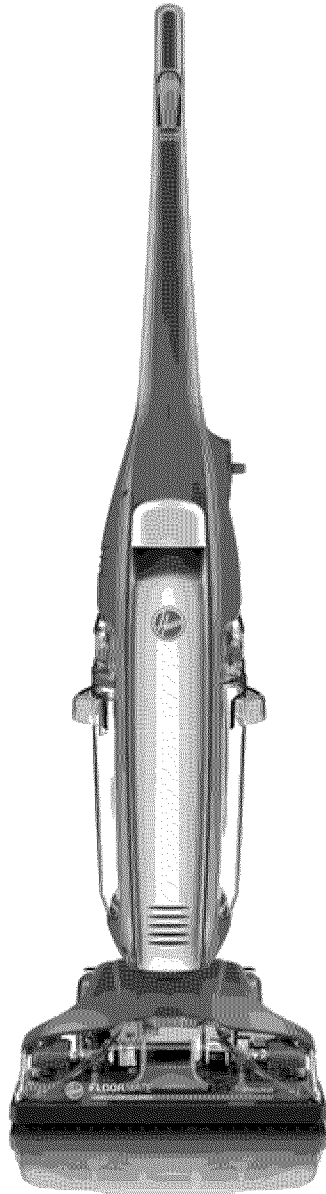

IMPORTANT: READ CAREFULLY BEFORE ASSEMBLY AND USE.

Questions or concerns? For assistance, please call Customer Service at
1-800-944-9200 Mon-Fri 8am-7pm EST before returning this product to the store.

**THIS PRODUCT IS INTENDED FOR HOUSEHOLD USE ONLY.
IF USED COMMERCIALY WARRANTY IS VOID.**

©2014 Techtronic Floor Care Technology Limited. All Rights Reserved.
Distributed by Royal Appliance Mfg. Co. Glenwillow, Oh 44139 #961151926 ID111348-R0

Thank you for choosing a HOOVER® product.

Please enter the complete model and Manufacturing Code in the spaces provided.

MODEL _____

MFG. CODE _____

Hint: Attach your sales receipt to this owner's manual. Verification of date of purchase may be required for warranty service of your HOOVER® product.

Be sure to register your product online at Hoover.com or call 1-800-944-9200 to register by phone.



MANUFACTURING CODE
(Label located on rear of cleaner)

CONTENTS

Important Safeguards	3
Features	5
Carton Contents	6
How To Assemble	7
General Operation	8
Clean Water/Solution Tank.....	8
How To Use	9
On-Off Switch.....	9
Handle Release Pedal	9
Transporting	9
Carry Handle.....	9
How To Empty	9
Dirty Water Tank.....	9
How To Clean	10
Maintenance	12
Nozzle	12
Brushes.....	12
Storage	13
Troubleshooting	14
Cleaning Products	15
Service	16
Warranty	17

If you need assistance:

Visit our website at hoover.com for more information or for video instruction for this Hard Floor Cleaner. Follow the authorized dealer locator link to find the Hoover® authorized dealer nearest you or call 1-800-944-9200 for an automated referral of Hoover® authorized dealer locations (U.S. only) or to speak with a customer service representative; Mon-Fri 8am-7pm EST.

PLEASE DO NOT RETURN THIS PRODUCT TO THE STORE.

IMPORTANT SAFETY INSTRUCTIONS

SAVE THESE INSTRUCTIONS

When using an electrical appliance, basic precautions should always be followed, including the following:

READ ALL INSTRUCTIONS BEFORE USING THIS APPLIANCE.

WARNING: TO REDUCE THE RISK OF FIRE, ELECTRIC SHOCK OR INJURY:

- Fully assemble before operating.
- Operate cleaner only at voltage specified on data plate on lower handle of cleaner.
- Do not leave appliance when plugged in. Unplug from outlet when not in use and before cleaning or servicing.
- Use indoors only.
- Use only HOOVER® cleaning products intended for use with this machine. (See the “Cleaning Products” section of this manual.)
- Do not allow to be used as a toy. Not intended for use by children age 12 and under. Close supervision is necessary when used near children. To avoid injury or damage, keep children away from product, and do not allow children to place fingers or other objects into any openings.
- Use only as described in this manual. Use only manufacturer’s recommended attachments and products.
- Do not use with damaged cord or plug. If appliance is not working as it should, has been dropped, damaged, left outdoors, or dropped into water, take it to a service center prior to continuing use.
- Do not pull or carry by cord, use cord as a handle, close a door on cord, or pull cord around sharp edges or corners. Do not place product on cord. Do not run appliance over cord. Keep cord away from heated surfaces.
- Do not unplug by pulling on cord. To unplug, grasp the plug, not the cord.
- Do not handle plug or appliance with wet hands.
- Do not put any object into openings. Do not use with any opening blocked; keep free of dust, lint, hair, and anything that may reduce air flow.
- Keep hair, loose clothing, fingers, and all parts of body away from openings and moving parts.
- Turn off all controls before unplugging.
- Use extra care when cleaning on stairs. To avoid personal injury or damage, and to prevent the cleaner from falling, always place cleaner at bottom of stairs or on floor. Do not place cleaner on stairs or furniture, as it may result in injury or damage.
- Do not use to pick up flammable or combustible materials, such as gasoline, or fine wood sandings, or use in areas where they may be present.
- Connect to a properly grounded outlet only. See Grounding Instructions.
- Not intended for use on carpets.
- Do not pick up anything that is burning or smoking, such as cigarettes, matches, or hot ashes.
- Do not use without Tanks or Filters in place.
- Do not clean over floor electrical outlets.
- **WARNING:** This product contains chemicals known to the State of California to cause cancer, birth defects or reproductive harm. ***WASH HANDS AFTER HANDLING.***

CAUTION - TO REDUCE THE RISK OF DAMAGE:

- Avoid picking up hard, sharp objects with this product, as they may cause damage.
- Store appropriately indoors in a dry place. Do not expose machine to freezing temperatures.
- Do not use sharp objects to clean out hose as they can cause damage.
- To assist in reducing drying time, be certain the area is well ventilated when using detergents and other cleaners with this machine.
- With brushes on, do not allow cleaner to sit in one location for an extended period of time, as damage to the floor can result.
- Water will drip from the brushes and underside of the product after use and may puddle. To avoid damage to wood and laminate flooring and to avoid potential slip hazard, after use (a) do not leave the product on wood and laminate surfaces and remove to a hard surface and (b) place unit on absorbent material (such as a towel) to soak up drips.
- Check and follow flooring manufactures warranty and recommendations regarding the use of hard floor cleaning machines **prior** to using this product on your sealed hard floors.

GROUNDING INSTRUCTIONS

This appliance must be grounded. If it should malfunction or breakdown, grounding provides a path of least resistance for electric current to reduce the risk of electric shock. This appliance is equipped with a cord having an equipment-grounding conductor (C) and grounding plug (A). The plug must be inserted into an appropriate outlet (B) that is properly installed and grounded in accordance with all local codes and ordinances.

WARNING: Improper connection of the equipment-grounding conductor can result in the risk of electric shock. Check with a qualified electrician or service person if you are in doubt as to whether the outlet is properly grounded. Do not modify the plug provided with the appliance - if it will not fit the outlet, have a proper outlet installed by a qualified electrician. This appliance is for use on a nominal 120-volt circuit and has a grounding plug that looks like the plug (A) illustrated in Fig. 1. A temporary adapter (D) may be used to connect this plug to a 2-pole receptacle (E) if a properly grounded outlet is not available (Fig. 2). The temporary adapter should be used only until a properly grounded outlet (B) can be installed by a qualified electrician (Fig. 1). The green colored rigid ear, lug, or the like (F) extending from the adapter must be connected to a permanent ground (G) such as a properly grounded outlet box cover (Fig. 2). Whenever the adapter is used, it must be held in place by a metal screw. **NOTE:** In Canada, the use of a temporary adapter is not permitted by the Canadian Electrical Code.

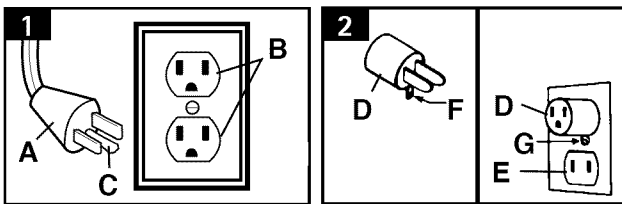

FEATURES

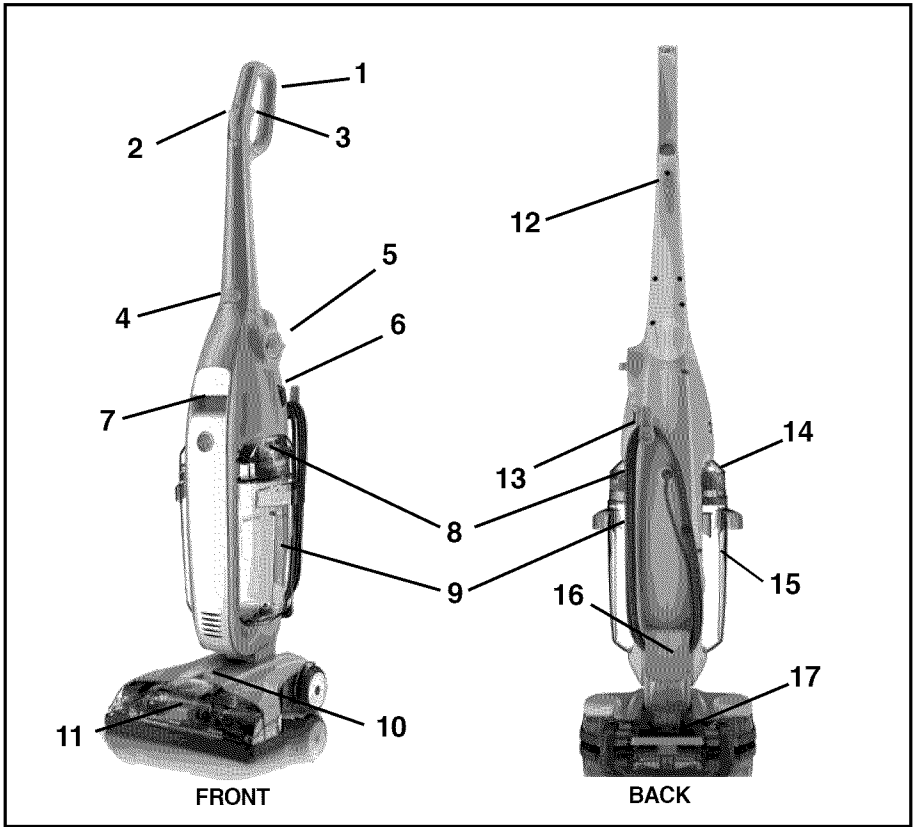

FEATURES

1. D-Shaped Handle
2. Clean Boost™ Trigger
3. Solution Trigger
4. Folding Handle Release Button (FH40165 & FH40170 series)
5. Mode Selection
6. ON/OFF Switch
7. Carry Handle
8. Clean Water/Solution Tank Release Button
9. Clean Water/Solution Tank
10. Nozzle Release
11. Nozzle
12. Cord Clip
13. Cord Storage Hook (rotates)
14. Dirty Water Tank Release Button
15. Dirty Water Tank
16. Cord Storage Hook
17. Handle Release Pedal

1. CARTON CONTENTS

CARTON CONTENTS FOR FLOORMATE FH40150 SERIES

- A. Hard Floor Cleaner Base (Floormate FH40150 Series)
- B. Upper Handle
- C. SpinScrub™ Multi-Floor Brush (assembled in unit)
- D. Screw
- E. Hard Floor Cleaning Detergent
- F. Removable Nozzle

Remove all parts from carton and identify each item shown.

Make sure all parts are located before disposing of packing materials.

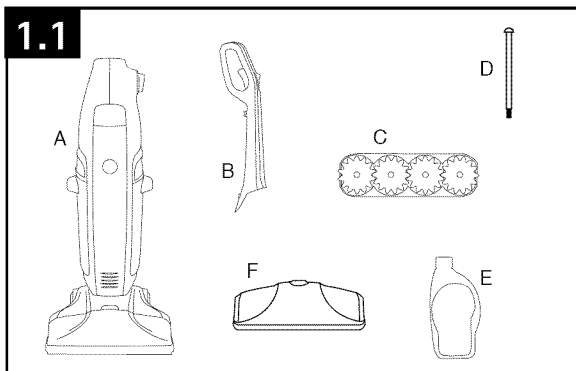

FH40150 SERIES

CARTON CONTENTS FOR FLOORMATE DELUXE FH40160 SERIES

- A. Hard Floor Cleaner Base (Floormate Deluxe FH40160 Series)
- B. Upper Handle
- C. SpinScrub™ Wood Floor Brush (assembled in unit)
- D. SpinScrub™ Tile & Grout Brush (assembled in unit)
- E. Screw
- F. Hard Floor Cleaning Detergent
- G. Removable Nozzle

Remove all parts from carton and identify each item shown.

Make sure all parts are located before disposing of packing materials.

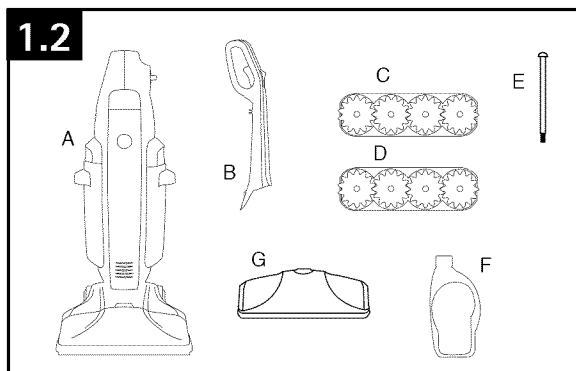

FH40160 SERIES

CARTON CONTENTS FOR FLOORMATE DELUXE FH40165 & FH40170 SERIES

- A. Hard Floor Cleaner Base (Floormate Deluxe FH40165 & FH40170 Series)
- B. SpinScrub™ Wood Floor Brush (assembled in unit)
- C. SpinScrub™ Tile & Grout Brush (assembled in unit)
- D.* Hard Floor Cleaning Detergent
*Number of bottles may vary by model

E. Removable Nozzle
Remove all parts from carton and identify each item shown.

Make sure all parts are located before disposing of packing materials.

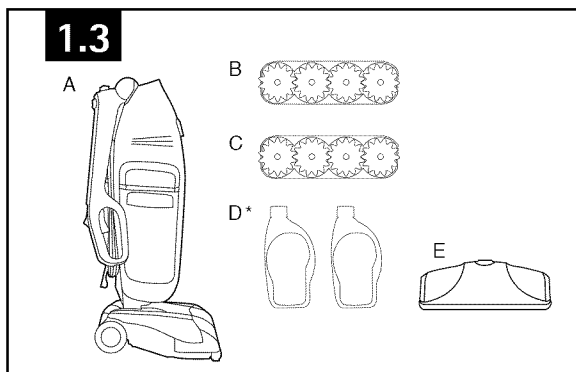

FH40165 & FH40170 SERIES

2. HOW TO ASSEMBLE

ATTACH HANDLE FH40150 & FH40160 SERIES

NOTE: PHILLIPS SCREWDRIVER NEEDED FOR ASSEMBLY.

2.1 Position upper handle and slide down into hard floor cleaner base.

2.2 Insert screw and tighten with screwdriver.

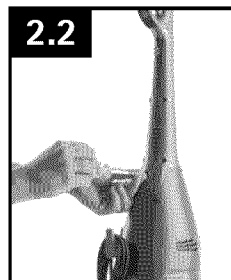
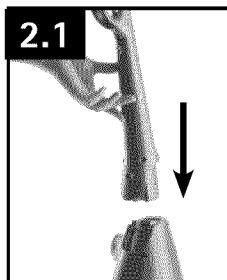

HOW TO FOLD HANDLE FH40165 & FH40170 SERIES

2.3 Simply rotate handle to upright position until it locks into place to get started.

2.4 For product storage, press folding handle release button and rotate handle down.

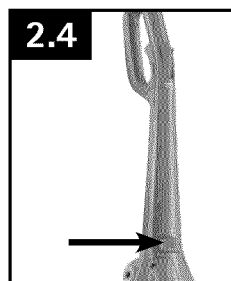
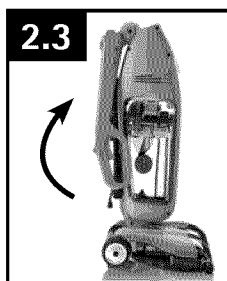

ATTACH NOZZLE

2.5 Remove nozzle from packaging. Align nozzle's 2 hooks with 2 slots on front of base.

2.6 Tilt nozzle upwards until latch (A) clips in place.

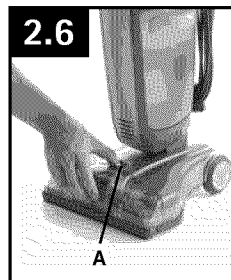
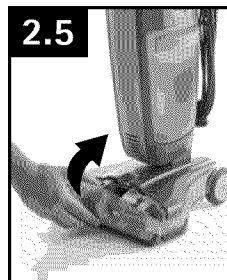

3. GENERAL OPERATION

Your HOOVER® FloorMate™ Hard Floor Cleaner is to be used on non-carpeted floor surfaces such as vinyl, tile and sealed wood. It is not intended for use on carpet or rugs.

⚠ CAUTION ⚠

To prevent damage to wood floors, follow the flooring manufacturer's cleaning recommendations.

If using cleaner on sealed wood floors, inspect floor surface for worn finish, bare wood or separated joints. Do not use FloorMate™ Hard Floor Cleaner to clean sealed wood floors if any of these conditions exist.

THE TANKS (when facing unit) Clean Water/Solution Tank (right side)

The Solution Tank holds detergent and water that is to be dispersed onto the surface being cleaned.

⚠ WARNING ⚠

To reduce the risk of personal injury, unplug before cleaning or servicing. Do not use cleaner without tank in place.

How to Fill

Place cleaner handle in upright, locked position.

3.1 To remove tank, squeeze release button (A) and pull tank straight out. Carry tank to sink.

3.2 Rotate tank cap counter-clockwise and lift up to remove cap (B).

3.3 Fill tank to fill line with warm water.

• IMPORTANT •

Check for worn spots or joint separations before using, as these conditions could lead to damaged flooring when using water to clean floor.

3.4 Turn cap upside down to serve as a measuring cap.

3.5 For FloorMate FH40150 Series, fill measuring cap to fill line once (3/4 oz - 22 ml) with Hoover® 2x Multi-Floor Plus Cleaning Solution and pour cleaning concentrate into Solution Tank.

For FloorMate Deluxe FH40160/FH40165/FH40170 Series, fill measuring cap to fill line twice (1.5 oz - 44 ml) and pour cleaning concentrate into Solution Tank.

3.6 Replace cap. Rotate cap clockwise until it locks in place (C). Cap must be locked in place for proper performance and to prevent leaking.

3.7 Slide tank straight into position until latch snaps in place.

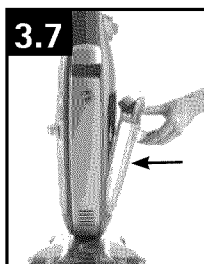
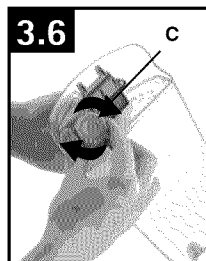
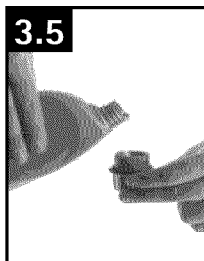
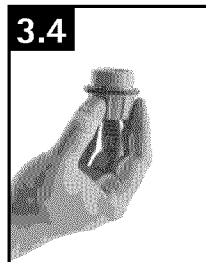
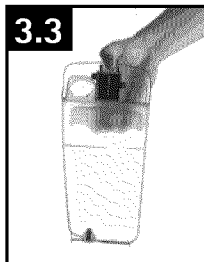
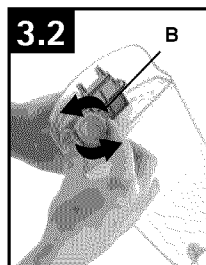
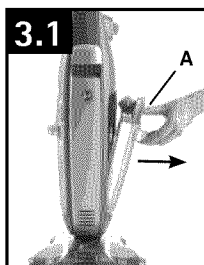

4. HOW TO USE

HANDLE RELEASE PEDAL

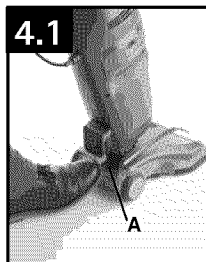

Step on pedal (A) to lower handle to operating position. Handle does not lock into a single position, but "floats" to allow convenient operation.

ON/OFF SWITCH

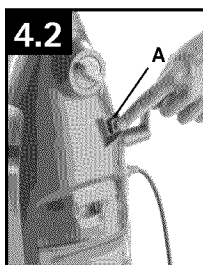

Push switch (A) once to turn cleaner ON. Push switch again to turn cleaner OFF.

TRANSPORTING

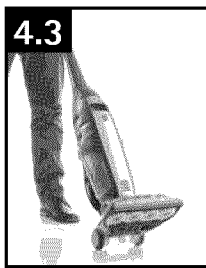

To move your cleaner from room to room, put handle in upright position, tilt cleaner back on rear wheels and push forward.

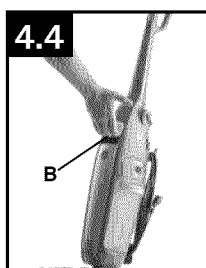

The cleaner may also be lifted using the carry handle (B) on front of cleaner.

CORD STORAGE

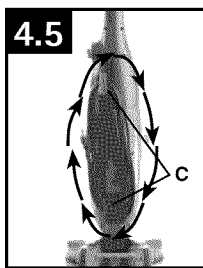

Enrouler le cordon dans le sens horaire autour des deux crochets pour cordon (C). Pour un rangement pratique, raccorder la fiche au cordon.

5. HOW TO EMPTY

Dirty Water Tank (left side when facing unit)

When to Empty

An automatic suction shut-off is built into the dirty water tank to prevent the tank from overflowing.

When the shut-off activates, the cleaner will not pick up water or debris and the sound of the motor will change. The dirty water tank is full and must be emptied.

How to Empty

5.1 To remove tank, press down on release button (A) and pull tank straight out.

5.2 Release tabs (B & C) on each side of the dirty water tank to unlock the top portion of the tank.

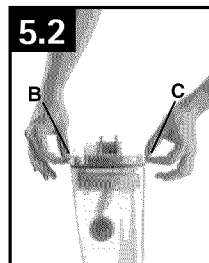
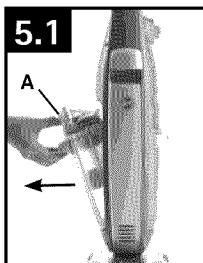
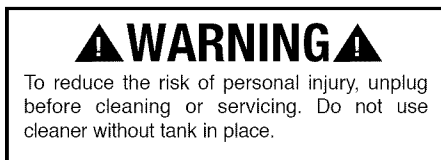

5.3 Pull up on tank lid to separate from the base.

5.4 Pour dirty water into sink.

5.5 Check foam filter for debris before reassembly. If filter has debris, rinse with water.

5.6 When finished emptying the tank, simply place lid back onto the tank and make sure to latch the tabs on each side back into the locked position.

5.7 Tilt tank straight into position until latch snaps in place.

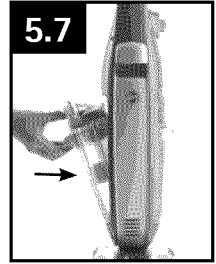
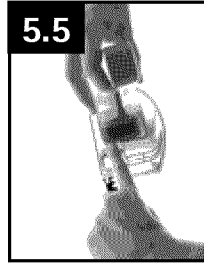
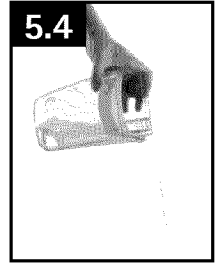
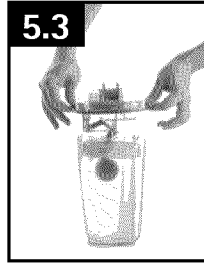

6. HOW TO CLEAN

RECOMMENDED CLEANING SEQUENCE

NOTE: Your HOOVER® FloorMate™ Hard Floor Cleaner may be used to clean wood floors that have been sealed with a polyurethane coating and can be cleaned with water.

⚠ CAUTION ⚠

To prevent damage to wood floors, follow the flooring manufacturer's cleaning recommendations. If using cleaner on sealed wood floors, inspect floor surface for worn finish, bare wood or separated joints. Do not use FloorMate™ Hard Floor Cleaner to clean sealed wood floors if any of these conditions exist.

6.1 Vacuum floor to remove loose dirt, hair and debris.

6.2 Fill Clean Water Solution Tank with Hoover® 2X Multi-Floor Plus Cleaning solution and water (refer to 3.1 thru 3.7).

• IMPORTANT •

Do not use solvent based cleaning concentrates in your cleaner. Do not use any type of wax in your cleaner.

Dry hands and plug cleaner into a properly grounded outlet.

6.3 Step on handle release pedal and lower handle to operating position.

6.4 Turn cleaner ON.

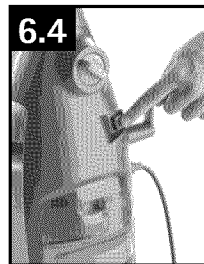
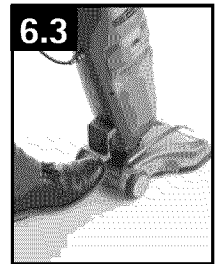
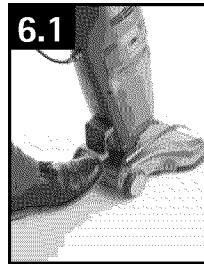

⚠ CAUTION ⚠

Do not clean over floor electrical outlets.

⚠ CAUTION ⚠

Water will drip from the brushes and underside of the product after use and may puddle. To avoid damage to wood and laminate flooring and to avoid potential slip hazard, after use A) do not leave the product on wood and laminate surfaces and remove to a hard surface and B) place unit on absorbent material (such as a towel) to soak up drips.

6.5 Wash Mode - Lowers the SpinScrub™ brushes to make contact with the floor for scrubbing action.

6.6 Dry Mode - Raises the SpinScrub™ brushes off of the floor and also stops the spinning of the brushes.

6.7 Scrub Mode - (FH40170 Series only) Lowers the SpinScrub™ brushes to the floor and stops the suction for extra cleaning with solution and water. Switch to dry mode to pick up any remaining dirty water.

6.8 To release solution, squeeze trigger (A)

6.9 Slowly move cleaner forward and backward over area to be cleaned. Squeeze trigger to release solution as needed.

6.10 Overlap strokes by one inch to help prevent streaking. The cleaner's suction will pick up the dirty water throughout cleaning.

6.11 To remove those tough stains, apply extra cleaning solution by squeezing the trigger (B) as you normally would and also pressing the Clean Boost™ trigger (C) at the same time.

To greatly enhance drying of the floor surface, release trigger. Continue to move cleaner over the area to pick up the dirty solution.

Switch to dry mode to pick up any remaining dirty water.

To continue cleaning another area, repeat steps 6.8 through 6.10.

NOTE: When cleaning sealed wood floors, make sure all areas are completely dry. Ensure that no water remains on the floor.

Empty dirty water tank when the motor sound becomes higher in pitch and there is a loss of suction.

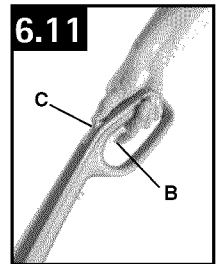
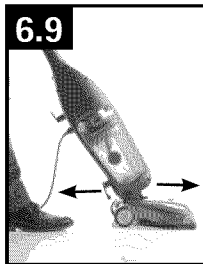
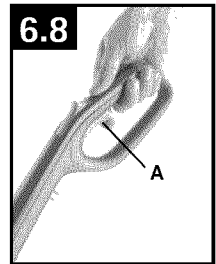
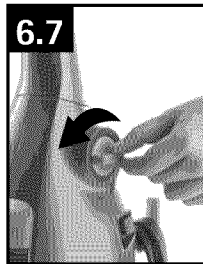
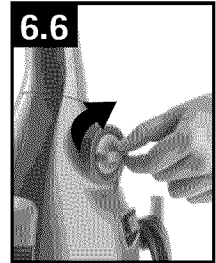
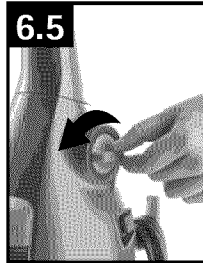

PICKING UP SPILLS

Your cleaner may also be used to pick up small liquid spills one and a half quarts or less in Dry Mode, never to exceed 1/4 inch in depth on non-carpeted floors. Release the trigger and continue to move cleaner over the area to pick up the spill.

⚠ CAUTION ⚠

Do not use the cleaner to pick up flammable or combustible liquids or chemicals.

7. MAINTENANCE

CLEANING THE NOZZLE

The cleaner's nozzle can be removed for easy cleaning.

⚠ CAUTION ⚠

To reduce the risk of injury from moving parts—Unplug before servicing. Do not use cleaner without nozzle in place.

7.1 Pull on nozzle release latch (A) upward.

7.2 Remove nozzle by rotating nozzle.

Rinse nozzle under running water. Remove debris from squeegee (C) and wipe with a damp cloth.

7.3 To reattach nozzle, tilt cleaner backwards so the front of the foot is 2-3" off of the floor. Secure upper handle with one hand and align nozzle squeegee with base from left to right with your other hand.

7.4 Simply rotate nozzle upward to lock in place.

Any other servicing should be done by an authorized service representative. If appliance is not working as it should, has been dropped, damaged, left outdoors, or dropped into water, take it to a service center prior to continuing use.

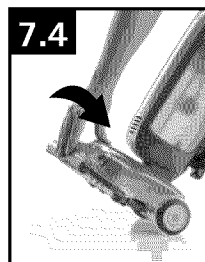
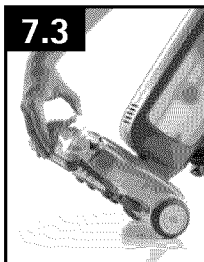
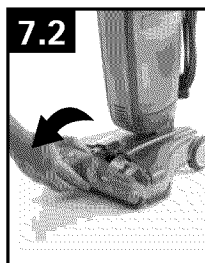
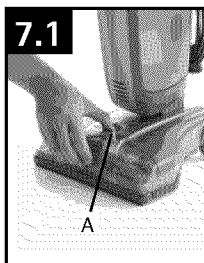

CLEANING THE BRUSHES

The brush assembly can be removed for easy cleaning when the nozzle is completely removed. (See "CLEANING THE NOZZLE" section)

⚠ CAUTION ⚠

To reduce the risk of injury from moving parts—Unplug before servicing. Do not use cleaner without brushes in place.

Remove both tanks to prevent leaking. Set aside.

Remove nozzle (7.1-7.2).

Release foot pedal and tilt cleaner back so handle rests on floor.

7.5 Push two brush release buttons (B) and remove the brush assembly.

7.6 The brushes can be washed with a mild detergent and rinsed. Do not use a solvent based detergent.

To replace brushes, align post (C) on brush block with hole (D) on bottom of cleaner. Turn brushes slightly until post fits easily into hole. Press brush assembly firmly to snap into place.

Return cleaner to upright position. Replace nozzle (7.4-7.5), making sure it is locked into position.

Return tanks into proper positions.

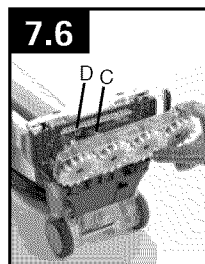
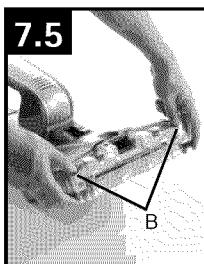

LUBRICATION

The motor is equipped with bearings which contain sufficient lubrication for its lifetime. The addition of lubricant could cause damage. Do not add lubricant to motor.

8. STORAGE

STORING CLEANER

Turn cleaner OFF and disconnect from electrical outlet.

- Empty and rinse Clean Water Solution Tank and Dirty Water Tank. Allow to air dry.
- Make sure that nothing is pressing on the nozzle squeegee.
- Do not store cleaner on a wood surface unless cleaner is completely dry.
- Store appropriately indoors in a dry place. Do not expose machine to freezing temperatures.
- Water will drip from the brushes and underside of the product after use and may puddle. To avoid damage to wood and laminate flooring and to avoid potential slip hazard, after use A) do not leave the product on wood and laminate surfaces and remove to a hard surface and B) place unit on absorbent material (such as a towel) to soak up drips.

9. TROUBLESHOOTING

If a minor problem occurs, it usually can be solved quite easily when the cause is found by using the checklist below.

Any other servicing should be done by an authorized service representative. If appliance is not working as it should, has been dropped, damaged, left outdoors, or dropped into water, take it to a service center prior to continuing use.

⚠ WARNING ⚠

To reduce risk of personal injury - Unplug before cleaning or servicing.

PROBLEM	POSSIBLE CAUSE	POSSIBLE SOLUTION
Cleaner won't run	1. Power cord not firmly plugged into outlet.	1. Plug unit in firmly.
	2. No voltage in wall plug.	2. Check fuse or breaker in home.
	3. Blown fuse or tripped breaker.	3. Replace fuse/reset breaker in home.
	4. Power switch not on.	4. Turn power switch on.
Low suction or won't pick up	1. Dirty Water Tank full and the automatic shut-off engaged.	1. Empty the Dirty Water Tank.
	2. Tanks not in place.	2. Make sure tanks are locked in place.
	3. Dirty Water Tank lid not in place.	3. Make sure lid is properly positioned.
	4. Nozzle not in place.	4. Make sure Nozzle is replaced properly and locked.
Water puddling behind cleaner	1. Clean Water Solution Tank not in place.	1. Make sure Clean Water Solution Tank is installed properly.
	2. Dirty water tank full.	2. Empty dirty water tank.
Cleaner solution won't dispense	1. Tanks not in place.	1. Make sure tanks are locked in place.
	2. Clean Water Solution Tank is empty.	2. Refill Clean Water Solution Tank.
Brushes wont rotate	1. Blown fuse or tripped breaker.	1. Check fuse or breaker in home. Replace fuse/reset breaker in home. (1) Push ON/OFF switch to turn cleaner OFF. (2) Unplug the cleaner. (3) Wait one minute. (4) Plug the cleaner into electrical outlet. (5) Push the ON/OFF switch again to turn cleaner ON. If the brushes continue to stall and the breaker trips again, clean the brushes to remove debris.
	2. In Dry Mode.	2. Switch mode selector to Wash Mode for brushes to rotate.

10. CLEANING PRODUCTS

WARNING: To reduce the risk of fire and electric shock due to internal component damage, use only Hoover® cleaning products and Hoover® hard surface attachments intended for use with the appliance as noted below.

Hoover® Cleaning Product Guide

Product Name	Clean Plus 2x 32oz/64oz	Pet Plus 2x 32oz/64oz	Anti-Allergen 2x ¹ 32oz/64oz	Multi-Floor Plus 2x 32oz/64oz	Hoover Platinum Collection® Professional Strength 50oz	Hoover Platinum Collection® Pet Plus 50oz	Hoover® Pro-Plus Carpet and Upholstery Detergent 2x 32oz/64oz
Hoover® Quick & Light™	✓	✓	✓		✓	✓	✓
Hoover® SteamVac®	✓	✓	✓	✓ ²	✓	✓	✓
Hoover® MaxExtract® Dual V®	✓	✓	✓	✓ ³	✓	✓	✓
Hoover® SteamVac® All Terrain	✓	✓	✓	✓	✓	✓	✓
Hoover Platinum Collection®	✓	✓	✓		✓	✓	✓
Hoover® FloorMate®				✓			
Hoover® MaxExtract® 60	✓	✓	✓	✓ ⁴	✓	✓	✓
Hoover® MaxExtract® 77	✓	✓	✓	✓	✓	✓	✓

¹ Allergens: pollen, pet dander, dirt, and dust.

² When cleaning a hard surface, the Hoover® hard surface attachment below must be used (optional if not included):
5 Brush/Dual Brush Hoover® part # 48417008.

³ When cleaning a hard surface, the optional Hoover® hard surface attachment below must be used:

6 Brush Hoover® part # 36419008
5 Brush No longer available.

⁴ When cleaning a hard surface, the optional Hoover® hard surface attachment below must be used:

6 Brush Hoover® part # 302658001

For optimal performance use Hoover brand detergents, wipes, and spot cleaners available at Hoover.com and retailers nationwide.

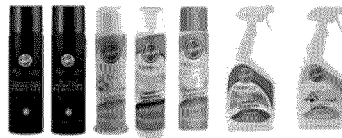

11. SERVICE

To obtain approved Hoover® service and genuine Hoover® parts, locate the nearest Authorized Hoover® Warranty Service Dealer (Depot) by:

- Checking the Yellow Pages under “Vacuum Cleaners” or “Household”.
- Visit our website at hoover.com (U.S. Customers) or hoover.ca (Canadian customers). Follow the service center link to find the service outlet nearest you.
- For an automated referral of authorized service outlet locations call 1-800-944-9200.

Do not send your vacuum to Hoover®, Inc., Company in Glenwillow for service. This will only result in delay.

If you need further assistance:

To speak with a customer service representative call 1-800-944-9200; Mon-Fri 8am-7pm EST. In Canada, contact Hoover® Canada, Toronto: 755 Progress Ave., Scarborough, ON M1H 2W7 OR Hoover® Canada, Edmonton: 18129-111 Ave., Edmonton, AB T5W 2P2, Phone: 1-800-944-9200, Mon-Fri 8am-7pm EST. Always identify your vacuum by the complete model number when requesting information or ordering parts. (The model number appears on the bottom of the vacuum.)

PLEASE DO NOT RETURN THIS PRODUCT TO THE STORE.

12. WARRANTY

LIMITED TWO YEAR WARRANTY

(Domestic Use)

WHAT THIS WARRANTY COVERS

When used and maintained in normal household use and in accordance with the Owner's Manual, your HOOVER® product is warranted against original defects in material and workmanship for a full two year from date of purchase (the "Warranty Period"). During the Warranty Period, Hoover® will provide labor and parts, at no cost to you, to correct any such defect in products purchased in the United States, U.S. Military Exchanges and Canada.

HOW TO MAKE A WARRANTY CLAIM

If this product is not as warranted, take or send the product to either a Hoover® Sales and Service Center or Hoover® Authorized Warranty Service Dealer along with proof of purchase. For an automated referral to authorized service outlets in the U.S.A., phone: 1-800-944-9200 OR visit Hoover® online at www.hoover.com. For additional assistance or information concerning this Warranty or the availability of warranty service outlets, phone the Hoover® Consumer Response Center, Phone 1-800-263-6376, Mon-Fri 8am-7pm EST. In Canada, contact Hoover® Canada, Carson Building, 100 Carson St., Etobicoke, Ontario M8W 3R9, Phone: 1-800-263-6376, Mon-Fri 8am-7pm EST.

WHAT THIS WARRANTY DOES NOT COVER

This Warranty does not cover: use of the product in a commercial operation (such as maid, janitorial and equipment rental services), improper maintenance of the product, damage due to misuse, acts of God, nature, vandalism or other acts beyond the control of Hoover®, owner's acts or omissions, use outside the country in which the product was initially purchased and resales of the product by the original owner. This warranty does not cover pick up, delivery, transportation or house

calls. However, if you mail your product to a Hoover® Sales and Service Center for warranty service, cost of shipping will be paid one way.

This warranty does not apply to products purchased outside the United States, including its territories and possessions, outside a U.S. Military Exchange and outside of Canada. This warranty does not cover products purchased from a party that is not an authorized retailer, dealer, or distributor of Hoover® products.

OTHER IMPORTANT TERMS

This Warranty is not transferable and may not be assigned. This Warranty shall be governed and construed under the laws of the state of Ohio. The Warranty Period will not be extended by any replacement or repair performed under this Warranty.

THIS WARRANTY IS THE EXCLUSIVE WARRANTY AND REMEDY PROVIDED BY HOOVER®. ALL OTHER WARRANTIES, EXPRESSED OR IMPLIED, INCLUDING WARRANTIES OF MERCHANTABILITY OR FITNESS FOR PARTICULAR PURPOSE, ARE DISCLAIMED. IN NO EVENT WILL HOOVER BE LIABLE FOR ANY SPECIAL, INDIRECT, INCIDENTAL OR CONSEQUENTIAL DAMAGES OF ANY KIND OR NATURE TO OWNER OR ANY PARTY CLAIMING THROUGH OWNER, WHETHER BASED IN CONTRACT, NEGLIGENCE, TORT OR STRICT PRODUCTS LIABILITY OR ARISING FROM ANY CAUSE WHATSOEVER. Some states do not allow the exclusion of consequential damages, so the above exclusion may not apply to you. This warranty gives you specific rights; you may also have others that vary from state to state.