



HE³

Gas Dryer

Use & Care Guide

Secadora de Gas

Manual de uso y cuidado

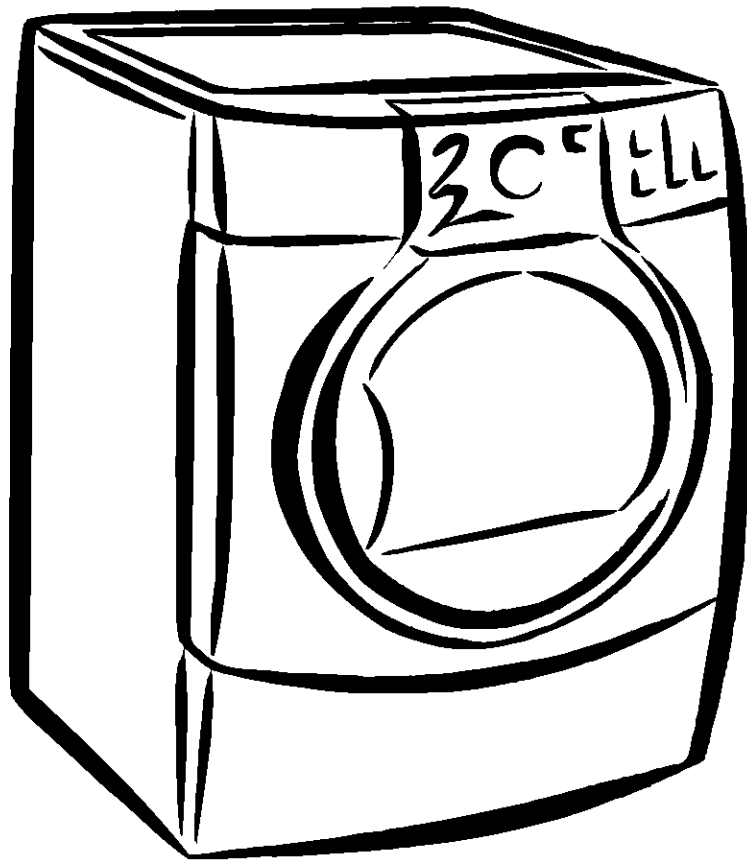

ENGLISH ESPAÑOL

TABLE OF CONTENTS

WARRANTY.....	2
PEDESTAL OPTION WARRANTY	2
DRYER SAFETY	3
INSTALLATION INSTRUCTIONS	5
Tools and Parts	5
Optional Pedestal	5
Location Requirements	5
Electrical Requirements.....	7
Gas Supply Requirements	7
Venting Requirements	8
Plan Vent System	9
Install Vent System	10
Install Leveling Legs	11
Level Dryer.....	11
Make Gas Connection.....	11
Connect Vent	12
Reverse Door Swing.....	12
Complete Installation.....	13
FEATURES AND BENEFITS	14
Automatic Temperature Control.....	14
Jeans Cycle	14
Ultra Delicate	14
DRYER USE	14
Starting Your Dryer	14
Stopping Your Dryer.....	15
Pausing or Restarting.....	15
Control Locked	15
Loading	15
Drying and Cycle Tips	15
Status Lights.....	16
Cycles	16
Options	17
Modifiers	17
Changing Cycles, Options and Modifiers	18
End of Cycle Signal	18
TUMBLE FREE™ Heated Dryer Rack.....	18
DRYER CARE.....	19
Cleaning the Dryer Location.....	19
Cleaning the Lint Screen	19
Cleaning the Dryer Interior	20
Removing Accumulated Lint	20
Vacation and Moving Care	20
Changing the Drum Light	20
TROUBLESHOOTING.....	20
PROTECTION AGREEMENTS.....	21
SERVICE NUMBERS	BACK COVER

WARRANTY

Full One-Year Warranty on Mechanical and Electrical Parts

For one year from the date of purchase, when this dryer is installed and operated according to the instructions provided in this Use and Care Guide, Sears will repair this dryer, free of charge, if defective in materials or workmanship.

NOTE: Exhausting this dryer with a plastic vent can void this warranty. See "Installation Instructions" for the complete exhaust requirements for this dryer.

Limited Two-Year Warranty on SENSOR SMART™ Electronic Control Board

For the second year from the date of purchase, Sears will replace the electronic control board if defective in material or workmanship. You will be charged for labor after the first year.

Warranty Restriction

If the dryer is subject to other than private family use, the above warranty coverage is effective for only 90 days.

Warranty Service

Warranty service is available by contacting the nearest Sears Service Center. This warranty applies only while the product is in use in the United States.

This warranty gives you specific legal rights and you may also have other rights which vary from state to state.

For Sears Warranty information or to contact a Sears Service Center, please refer to the service numbers located on the back page of this manual.

Sears, Roebuck and Co.
D/817WA, Hoffman Estates, IL 60179

Product Record

In the space following, record your complete model number, serial number, and purchase date. You can find this information on the model and serial number label, located at the top inside dryer door well.

Have this information available to help you quickly obtain assistance or service when you contact Sears concerning your appliance.

Model number 110.....
Serial number,
Purchase date

Save these instructions and your sales receipt for future reference.

PEDESTAL OPTION WARRANTY

Full One-Year Warranty on Mechanical Parts

For one year from the date of purchase, supplier will repair or replace any of its mechanical parts if defective in material or workmanship. This Pedestal must be installed with this dryer according to the instructions provided in the Pedestal Installation Instructions.

Warranty Restriction

If the Pedestal is subject to other than private family use and/or used with any other product than those listed in the installation instructions, this warranty is null and void.

In the space following, record your complete model number, serial number, and purchase date. You can find this information on the model and serial number label.

Have this information available to help you quickly obtain assistance or service when you contact Sears concerning your appliance.

Model number 110.....
Serial number,
Purchase date

Save these instructions and your sales receipt for future reference.

DRYER SAFETY

Your safety and the safety of others are very important.

We have provided many important safety messages in this manual and on your appliance. Always read and obey all safety messages.



This is the safety alert symbol.

This symbol alerts you to potential hazards that can kill or hurt you and others.

All safety messages will follow the safety alert symbol and either the word "DANGER" or "WARNING." These words mean:

⚠ DANGER

You can be killed or seriously injured if you don't immediately follow instructions.

⚠ WARNING

You can be killed or seriously injured if you don't follow instructions.

All safety messages will tell you what the potential hazard is, tell you how to reduce the chance of injury, and tell you what can happen if the instructions are not followed.

WARNING: For your safety, the information in this manual must be followed to minimize the risk of fire or explosion, or to prevent property damage, personal injury, or death.

- Do not store or use gasoline or other flammable vapors and liquids in the vicinity of this or any other appliance.
- **WHAT TO DO IF YOU SMELL GAS:**
 - Do not try to light any appliance.
 - Do not touch any electrical switch; do not use any phone in your building.
 - Clear the room, building, or area of all occupants.
 - Immediately call your gas supplier from a neighbor's phone. Follow the gas supplier's instructions.
 - If you cannot reach your gas supplier, call the fire department.
- Installation and service must be performed by a qualified installer, service agency, or the gas supplier.

IMPORTANT SAFETY INSTRUCTIONS

WARNING: To reduce the risk of fire, electric shock, or injury to persons when using the dryer, follow basic precautions, including the following:

- Read all instructions before using the dryer.
- Do not place items exposed to cooking oils in your dryer. Items contaminated with cooking oils may contribute to a chemical reaction that could cause a load to catch fire.
- Do not dry articles that have been previously cleaned in, washed in, soaked in, or spotted with gasoline, dry-cleaning solvents, other flammable, or explosive substances as they give off vapors that could ignite or explode.
- Do not allow children to play on or in the dryer. Close supervision of children is necessary when the dryer is used near children.
- Before the dryer is removed from service or discarded, remove the door to the drying compartment.
- Do not reach into the dryer if the drum is moving.
- Do not install or store the dryer where it will be exposed to the weather.
- Do not tamper with controls.
- Do not repair or replace any part of the dryer or attempt any servicing unless specifically recommended in this Use and Care Guide or in published user-repair instructions that you understand and have the skills to carry out.
- Do not use fabric softeners or products to eliminate static unless recommended by the manufacturer of the fabric softener or product.
- Do not use heat to dry articles containing foam rubber or similarly textured rubber-like materials.
- Clean lint screen before or after each load.
- Keep area around the exhaust opening and adjacent surrounding areas free from the accumulation of lint, dust, and dirt.
- The interior of the dryer and exhaust vent should be cleaned periodically by qualified service personnel.
- See installation instructions for grounding requirements.

SAVE THESE INSTRUCTIONS

IMPORTANT: The gas installation must conform with local codes, or in the absence of local codes, with the National Fuel Gas Code, ANSI Z223.1/NFPA 54.
The dryer must be electrically grounded in accordance with local codes, or in the absence of local codes, with the National Electrical Code, ANSI/NFPA 70.

INSTALLATION INSTRUCTIONS

Tools and Parts

Check that you have everything necessary for correct installation. Proper installation is your responsibility.

- 8 in. or 10 in. pipe wrench
- 8 in. or 10 in. adjustable wrench (for gas connections)
- Flat-blade screwdriver
- Adjustable wrench that opens to 1 in. (2.54 cm) or hex-head socket wrench (for adjusting dryer feet)
- Level
- ¼ in. nut driver or socket wrench
- Knife
- Safety glasses
- Duct tape
- Pipe-joint compound resistant to L.P. gas
- Caulking gun and compound (for installing new exhaust vent)
- Gloves
- Pliers

Parts supplied

Remove parts package from dryer drum. Check that all parts were included.

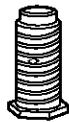

4 Leveling legs

NOTE: Do not use leveling legs if installing the dryer on a pedestal.

Parts needed

Check local codes and with gas supplier. Check existing gas supply, electrical supply and venting. Read “Electrical Requirements,” “Gas Supply Requirements” and “Venting Requirements” before purchasing parts.

- For close-clearance installations between 31.5 in. (80.01 cm) and 37 in. (93.98 cm), see “Plan Vent System” section for venting requirements.

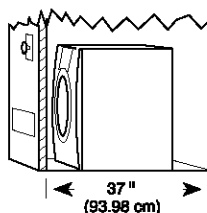

Mobile home installations require special parts (listed following) available for purchase from your local Sears store or Sears Service Center. For further information, please call **1-800-4-MY-HOME® (1-800-469-4663)**.

- Mobile Home Installation Kit. Ask for Part Number 346764.
- Metal exhaust system hardware.

Optional Pedestal

Are you placing the dryer on a pedestal? You can purchase a pedestal separately for this dryer. This pedestal will add about 14 in. (35.56 cm) to the height of your unit for a total height of approximately 52 in. (132.08 cm).

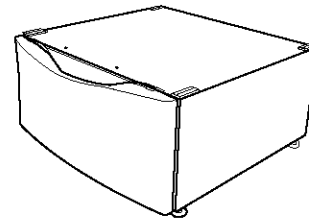

Optional pedestal

The pedestal is available in three colors

White - Part Number 42842

Biscuit - Part Number 42844

Graphite - Part Number 42846

To order, call your local Sears store. For further information, please call **1-800-4-MY-HOME® (1-800-469-4663)**.

Location Requirements

! WARNING



Explosion Hazard

Keep flammable materials and vapors, such as gasoline, away from dryer.

Place dryer at least 18 inches (46 cm) above the floor for a garage installation.

Failure to do so can result in death, explosion, or fire.

You will need

- A location that allows for proper exhaust installation. A gas dryer must be exhausted to the outdoors. See “Venting Requirements.”
- A grounded electrical outlet located within 2 ft (61 cm) of either side of the dryer. See “Electrical Requirements.”
- A sturdy floor to support the total dryer weight of 200 lbs (90.7 kg). The combined weight of a companion appliance should also be considered.
- A level floor with a maximum slope of 1 in. (2.5 cm) under entire dryer. (If slope is greater than 1 in. [2.5 cm], install Extended Dryer Feet Kit, Part No. 279810.) Clothes may not tumble properly and automatic sensor cycles may not operate correctly if dryer is not level.
- For a garage installation, you will need to place the dryer at least 18 in. (46 cm) above the floor. If using a pedestal, you will need an additional 6 in. (15.24 cm).

Do not operate your dryer at temperatures below 45°F (7°C). At lower temperatures, the dryer might not shut off at the end of an automatic cycle. Drying times can be extended.

The laundry center must not be installed or stored in an area where it will be exposed to water and/or weather.

Check code requirements. Some codes limit, or do not permit, installation of the dryer in garages, closets, mobile homes, or sleeping quarters. Contact your local building inspector.

NOTE: No other fuel-burning appliance can be installed in the same closet as a dryer.

Installation clearances

The location must be large enough to fully open the dryer door.

Dryer Dimensions

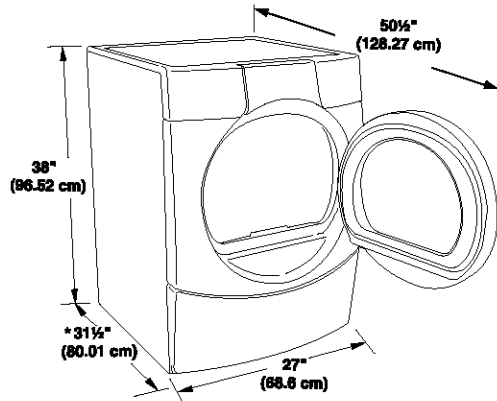

* Most installations require a minimum 5 1/2 in. (14 cm) clearance behind the dryer for the exhaust vent with elbow. See "Venting Requirements."

Minimum installation spacing for recessed area, custom undercounter or closet installation

The dimensions shown following are for the minimum spacing allowed.

- Additional spacing should be considered for ease of installation and servicing.
- Additional clearances might be required for wall, door and floor moldings.
- Additional spacing of 1 in. (2.5 cm) on all sides of the dryer is recommended to reduce noise transfer.
- For closet installation, with a door, minimum ventilation openings in the top and bottom of the door are required. Louvered doors with equivalent ventilation openings are acceptable.
- Companion appliance spacing should also be considered.

Custom undercounter installation - Dryer only

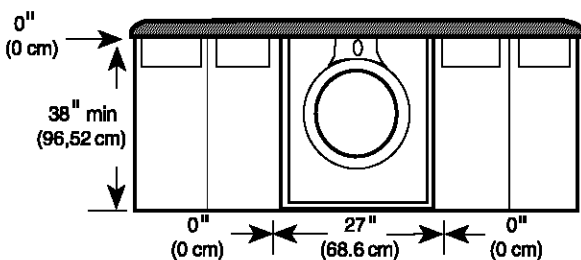

Closet installation - Dryer only

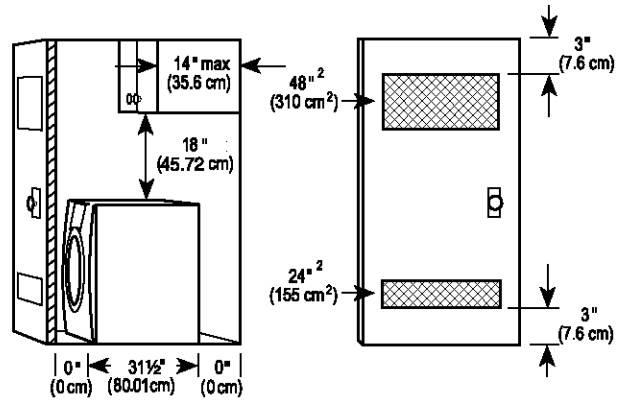

1. Side view - closet or confined area
2. Closet door with vents

Recessed or closet installation - Dryer on pedestal

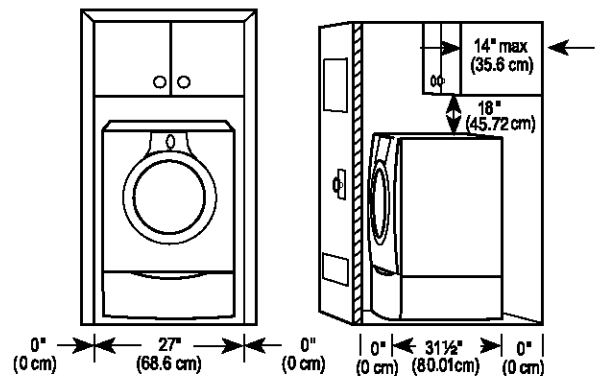

1. Recessed area
2. Side view - closet or confined area

Mobile home-additional installation requirements

This dryer is suitable for mobile home installations. The installation must conform to the Manufactured Home Construction and Safety Standard, Title 24 CFR, Part 3280 (formerly the Federal Standard for Mobile Home Construction and Safety, Title 24, HUD Part 280).

Mobile home installations require:

- Metal exhaust system hardware which is available for purchase from your local Sears store or Sears Service Center.
- Mobile home Installation Kit Part Number 346764. See "Tools and Parts" section for ordering information.
- Special provisions must be made in mobile homes to introduce outside air into the dryer. The opening (such as a nearby window) should be at least twice as large as the dryer exhaust opening.



Electrical Requirements

⚠ WARNING



Electrical Shock Hazard

Plug into a grounded 3 prong outlet.

Do not remove ground prong.

Do not use an adapter.

Do not use an extension cord.

Failure to follow these instructions can result in death, fire, or electrical shock.

- 120-Volt, 60-Hz., AC-only, 15- or 20-amp fused electrical supply is required. (Time-delay fuse or circuit breaker is recommended.) It is recommended that a separate circuit serving only this dryer be provided.

GROUNDING INSTRUCTIONS

- For a grounded, cord-connected dryer: This dryer must be grounded. In the event of malfunction or breakdown, grounding will reduce the risk of electric shock by providing a path of least resistance for electric current. This dryer is equipped with a cord having an equipment-grounding conductor and a grounding plug. The plug must be plugged into an appropriate outlet that is properly installed and grounded in accordance with all local codes and ordinances.

WARNING: Improper connection of the equipment-grounding conductor can result in a risk of electric shock. Check with a qualified electrician or service representative or personnel if you are in doubt as to whether the dryer is properly grounded. Do not modify the plug provided with the dryer: if it will not fit the outlet, have a proper outlet installed by a qualified electrician.

SAVE THESE INSTRUCTIONS

Gas Supply Requirements

⚠ WARNING



Explosion Hazard

Use a new AGA or CSA approved gas supply line.

Install a shut-off valve.

Securely tighten all gas connections.

If connected to LP, have a qualified person make sure gas pressure does not exceed 13" (33 cm) water column.

Examples of a qualified person include:

**licensed heating personnel,
authorized gas company personnel, and
authorized service personnel.**

**Failure to do so can result in death, explosion,
or fire.**

Gas Type

Natural gas:

This dryer is equipped for use with NATURAL GAS. It is design-certified by CSA International for LP. (propane or butane) gases with appropriate conversion.

- Your dryer must have the correct burner for the type of gas in your home. Burner information is located on the rating plate in the door well of your dryer. If this information does not agree with the type of gas available, contact your local Sears store or Sears Service Center.

L.P. gas conversion:

Conversion must be made by a qualified technician.

No attempt shall be made to convert the appliance from the gas specified on the model/serial rating plate for use with a different gas without consulting the serving gas supplier.

Gas supply line

- ½ in. IPS pipe is recommended.
- ¾ in. approved tubing is acceptable for lengths under 20 ft (6.1 m) if local codes and gas supplier permit.
- Must include ¼ in. NPT plugged tapping accessible for test gage connection, immediately upstream of the gas connection to the dryer (see following illustration).

- Must include a shutoff valve:

An individual shutoff valve must be installed within 6 feet (1.8 m) of the dryer in accordance with the National Fuel Gas Code, ANSI Z223.1. The location should be easy to reach for opening and closing.

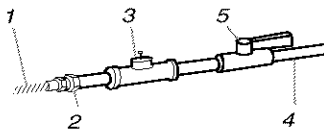

1. 3/8 in. flexible gas connector
2. 3/8 in. pipe to flare adapter fitting
3. 1/2 in. NPT plugged tapping
4. 1/2 in. NPT gas supply line
5. Gas shutoff valve

Gas supply connection requirements

There are many methods by which your gas dryer can be connected to the gas supply. Listed here are some guidelines for two different methods of connection.

Option 1 (Recommended method)

Flexible stainless steel gas connector:

- If local codes permit, use a new flexible stainless steel gas connector (Design Certified by the American Gas Association or CSA International) to connect your dryer to the rigid gas supply line. Use an elbow and a 3/8 in. flare x 3/8 in. NPT adapter fitting between the stainless steel gas connector and the dryer gas pipe, as needed to prevent kinking.

Option 2 (Alternate method)

Approved aluminum or copper tubing:

- Lengths under 20 ft (6.1 m) can use 3/8 in. approved tubing (if codes and gas supplier permit).
- If you are using natural gas, do not use copper tubing.
- 3/8 in. flare x 3/8 in. NPT adapter fitting between dryer pipe and 3/8 in. approved tubing.
- Lengths over 20 ft (6.1 m) should use larger tubing and a different size adapter fitting.
- If your dryer has been converted to use L.P. gas, 3/8 in. L.P. compatible copper tubing can be used. If the total length of the supply line is more than 20 ft (6.1 m), use larger tubing.

NOTE: Pipe joint compounds that resist the action of L.P. gas must be used. Do not use TEFLON[†] tape.

Dryer gas pipe

- The gas pipe that comes out through the rear of your dryer has a 3/8 in. male pipe thread.

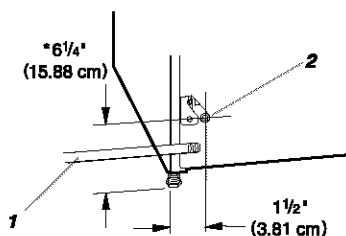

1. 1/2 in. NPT gas supply line
2. 3/8 in. NPT dryer pipe

***NOTE:** If the dryer is mounted on a pedestal, the gas pipe height must be an additional 14 in. (35.56 cm) from the floor.

Burner input requirements

Elevations up to 10,000 feet (3,048 meters):

- The design of this dryer is certified by CSA International for use at altitudes up to 10,000 ft (3,048 m) above sea level at the B.T.U. rating indicated on the model/serial number plate. Burner input adjustments are not required when the dryer is operated up to this elevation.

Elevations above 10,000 feet (3,048 meters):

- When installed above 10,000 ft (3,048 m) a 4% reduction of the burner B.T.U. rating shown on the model/serial number plate is required for each 1,000 ft (305 m) increase in elevation.

Gas supply pressure testing

- The dryer must be disconnected from the gas supply piping system during any pressure testing.

Venting Requirements

! WARNING



Fire Hazard

Use a heavy metal vent.

Do not use a plastic vent.

Do not use a metal foil vent.

Failure to follow these instructions can result in death or fire.

WARNING: To reduce the risk of fire, this dryer **MUST BE EXHAUSTED OUTDOORS.**

4 in. (10.2 cm) heavy metal exhaust vent and clamps must be used. DURASAFE™ venting products are recommended and are available from your local Sears store or Sears Service Center.

DURASAFE™ vent products can be purchased from your dealer. For further information, please call **1-800-4-MY-HOME®** (1-800-469-4663) or visit our Internet site at: www.sears.com.

- The dryer exhaust must not be connected into any gas vent, chimney, wall, ceiling, or a concealed space of a building.
- Do not use an exhaust hood with a magnetic latch.
- Do not install flexible metal vent in enclosed walls, ceilings or floors.
- Use clamps to seal all joints. Exhaust vent must not be connected or secured with screws or other fastening devices which extend into the interior of the duct. Do not use duct tape.

[†]@TEFLON is a registered trademark of DuPont

IMPORTANT: Observe all governing codes and ordinances.

Improper venting can cause moisture and lint to collect indoors, which may result in:

- Moisture damage to woodwork, furniture, paint, wall-paper, carpets, etc.
- Housecleaning problems and health problems.

Use a heavy metal vent. Do not use plastic or metal foil vent. Rigid metal vent is recommended to prevent crushing and kinking.

Flexible metal vent must be fully extended and supported when the dryer is in its final position. Remove excess flexible metal vent to avoid sagging and kinking that may result in reduced airflow and poor performance.

An exhaust hood should cap the vent to prevent rodents and insects from entering the home.

Exhaust hood must be at least 12 in. (30.5 cm) from the ground or any object that may be in the path of the exhaust (such as flowers, rocks or bushes, etc.).

If using an existing vent system, clean lint from the entire length of the system and make sure exhaust hood is not plugged with lint. Replace any plastic or metal foil vent with rigid metal or flexible metal vent.

Plan Vent System

Typical exhaust installations

Typical installations vent the dryer from the rear of the dryer. Other installations are possible.

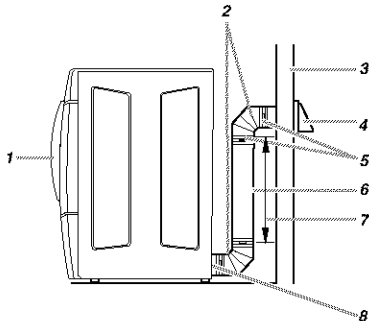

1. Dryer
2. Elbow
3. Wall
4. Exhaust hood
5. Clamps
6. Rigid metal or flexible metal vent
7. Vent length necessary to connect elbows
8. Exhaust outlet

Optional exhaust installations

This dryer can be converted to exhaust out the right side, left side, or through the bottom.

! WARNING



Fire Hazard

Cover unused exhaust holes with one of the following kits:

279818 (white)

279915 (graphite)

279925 (biscuit)

Contact your local dealer.

Failure to follow these instructions can result in death, fire, electrical shock, or serious injury.

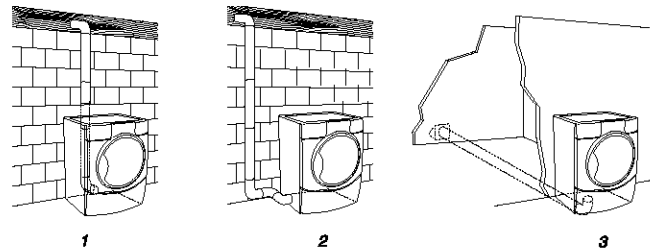

1. Standard rear offset exhaust installation
2. Left or right side exhaust installation
3. Bottom exhaust installation (Not an option with pedestal installations.)

Alternate installations for close clearances

Venting systems come in many varieties. Select the type best for your installation. Two close-clearance installations are shown. Refer to the manufacturer's instructions.

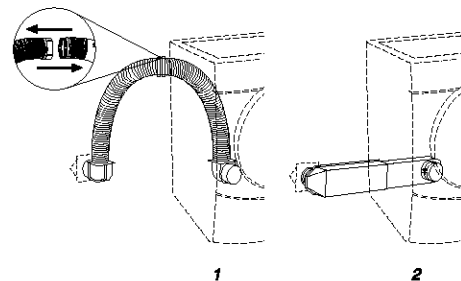

1. Over-The-Top installation (also available with one offset elbow)
2. Periscope installation

NOTE: The following kits for close clearance alternate installations are available for purchase. For further information, please call **1-800-4-MY-HOME® (1-800-469-4663)**.

■ **Over-The-Top Installation:**

Part Number 26-49900

■ **Periscope Installation (For use with dryer vent to wall vent mismatch):**

Part Number 26-49901 - Less than 5 in. (12.7 cm) mismatch

Part Number 26-49908 - 5 in. (12.7 cm) to 18 in. (45.72 cm) mismatch

Part Number 26-49904 - 18 in. (45.72 cm) to 29 in. (73.66 cm) mismatch

Part Number 26-49905 - 29 in. (73.66 cm) to 50 in. (127 cm) mismatch

Special provisions for mobile home installations

The exhaust vent must be securely fastened to a noncombustible portion of the mobile home structure and must not terminate beneath the mobile home. Terminate the exhaust vent outside.

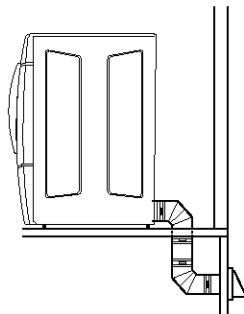

Determine Vent Length

1. Select the route that will provide the straightest and most direct path outdoors. Plan the installation to use the fewest number of elbows and turns. When using elbows or making turns, allow as much room as possible. Bend vent gradually to avoid kinking. Avoid 90° turns.

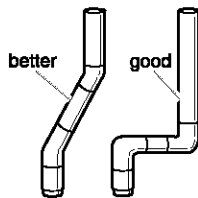

2. Determine vent length

The maximum length of the exhaust system depends upon:

- The type of vent (rigid metal or flexible metal).
- The number of elbows used.
- Type of hood.

Recommended hood styles are shown here.

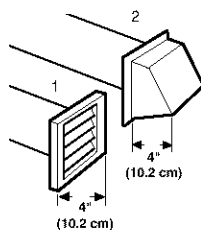

1. Louvered hood style
2. Box hood style

The angled hood style (shown following) is acceptable.

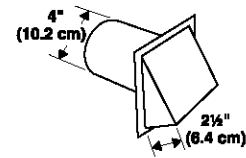

See the exhaust vent length chart that matches your hood type for the maximum vent lengths you can use.

Exhaust systems longer than specified will:

- Shorten the life of the dryer.
 - Reduce performance, resulting in longer drying times and increased energy usage.
3. Determine the number of elbows you will need.

IMPORTANT: Do not use vent runs longer than specified in the Vent Length Chart.

The chart below helps you determine your maximum vent length based on the number of 90° turns or elbows you will need and the type of vent (rigid or flexible metal) and hood that you will use.

Vent Length Chart

Number of 90° turns or elbows	Type of vent	Box or Louvered hoods	Angled hoods
0	Rigid metal	64 ft (20 m)	58 ft (17.7 m)
	Flexible metal	36 ft (11 m)	28 ft (8.5 m)
1	Rigid metal	54 ft (16.5 m)	48 ft (14.6 m)
	Flexible metal	31 ft (9.4 m)	23 ft (7 m)
2	Rigid metal	44 ft (13.4 m)	38 ft (11.6 m)
	Flexible metal	27 ft (8.2 m)	19 ft (5.8 m)
3	Rigid metal	35 ft (10.7 m)	29 ft (8.8 m)
	Flexible metal	25 ft (7.6 m)	17 ft (5.2 m)
4	Rigid metal	27 ft (8.2 m)	21 ft (6.4 m)
	Flexible metal	23 ft (7 m)	15 ft (4.6 m)

NOTE: Side and bottom exhaust installations have a 90° turn inside the dryer. To determine maximum exhaust length, add 1 90° turn to the chart.

Install Vent System

1. (Optional) Put on safety glasses and gloves.
2. Install exhaust hood. Use caulking compound to seal exterior wall opening around exhaust hood.
3. Connect vent to exhaust hood. Vent must fit inside exhaust hood. Secure vent to exhaust hood with 4 in. (10.2 cm) clamp.
4. Run vent to dryer location. Use the straightest path possible. See "Determine Vent Length." Avoid 90° turns. Use clamps to seal all joints. Do not use duct tape, screws or other fastening devices that extend into the interior of the vent to secure vent.



Install Leveling Legs

⚠ WARNING

Excessive Weight Hazard

Use two or more people to move and install dryer.

Failure to do so can result in back or other injury.

1. To protect the floor, use a large flat piece of cardboard from the dryer carton. Place cardboard under the entire back edge of the dryer. See illustration.
2. Firmly grasp the body of the dryer (not the console panel).

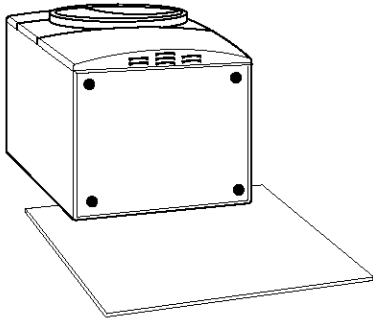

Gently lay the dryer on the cardboard.

3. Examine the leveling legs. Find the diamond marking.

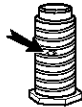

4. Screw the legs into the leg holes by hand. Use a wrench to finish turning the legs until the diamond marking is no longer visible.
5. Place a carton corner post under each of the 2 dryer back corners. Stand the dryer up. Slide the dryer on the corner posts until it is close to its final location. Leave enough room to connect the exhaust vent or gas line.
6. Once connection is made and dryer is in final location, remove corner posts and cardboard.

For mobile home use

Gas dryers must be securely fastened to the floor at the time of installation.

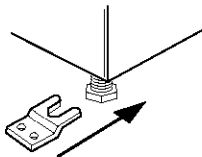

Mobile home installations require a Mobile Home Installation Kit. For more information, please reference the service numbers located on the back page of this manual.

Level Dryer

Check the levelness of the dryer. Check levelness first side-to-side, then front-to-back.

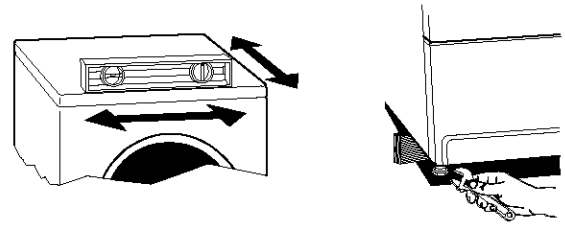

If the dryer is not level, prop up the dryer using a wood block. Use a wrench to adjust the legs up or down and check again for levelness.

NOTE: It might be necessary to level the dryer again after it has been moved into its final position.

Make Gas Connection

1. Remove the red cap from the gas pipe. Move the dryer close to its final position.
2. Using a wrench to tighten, connect the gas supply to the dryer. Use pipe joint compound on all non-flared male threads. If flexible metal tubing is used, be sure there are no kinks.

NOTE: For L.P. gas connections, you must use pipe joint compound resistant to the action of L.P. gas. Do not use TEFLON® tape.

A combination of pipe fittings must be used to connect the dryer to the existing gas line. Shown following is a recommended connection. Your connection may be different, according to the supply line type, size, and location.

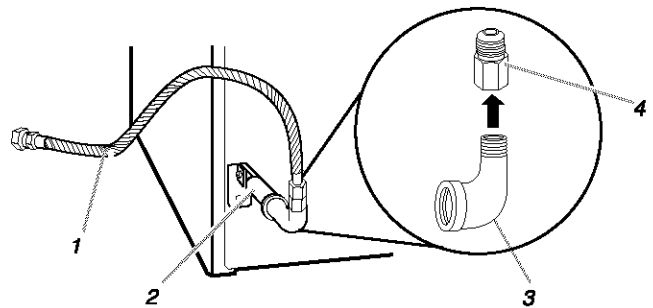

1. $\frac{3}{8}$ in. flexible gas connector
2. $\frac{3}{8}$ in. dryer pipe
3. $\frac{3}{8}$ in. to $\frac{1}{2}$ in. pipe elbow
4. $\frac{1}{2}$ in. pipe-to-flare adapter fitting

3. Open the shutoff valve in the supply line. The valve is open when the handle is parallel to the gas pipe.

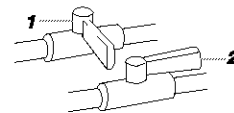

1. Closed valve
2. Open valve

4. Test all connections by brushing on an approved non-corrosive leak-detection solution. Bubbles will show a leak. Correct any leak found.

Connect Vent

1. Using a 4 in. (10.2 cm) clamp, connect vent to exhaust outlet in dryer. If connecting to existing vent, make sure the vent is clean. The dryer vent must fit over the dryer exhaust outlet and inside the exhaust hood. Make sure the vent is secured to exhaust hood with a 4 in. (10.2 cm) clamp.
2. Move dryer into final position. Do not crush or kink vent. Make sure dryer is level.
3. (On gas models) Check to be sure there are no kinks in the flexible gas line.

Reverse Door Swing

You can change your door swing from a right-side opening to a left-side opening, if desired.

Remove the door

1. Place a towel or soft cloth on top of the dryer or work space to protect the surface.
2. Open the dryer door. Remove the 5 screws that hold the door hinge on the front panel of the dryer. Loosen, but do not remove, the screw with the top keyhole opening LAST (2nd from the top).

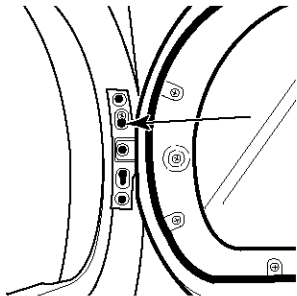

3. Lift and pull forward on the door so that the screwhead clears the keyhole. Remove the door.
4. Lay the dryer door on a flat, protected surface with the inside door assembly facing up. Remove the 6 screws to release the outer door assembly from the inner door assembly, as indicated below. See illustration. It is important that you remove ONLY the 6 indicated screws.

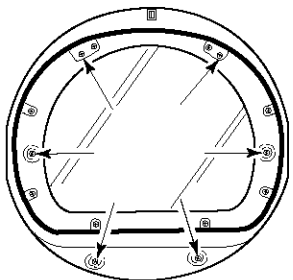

5. Lift the inner door assembly off of the outer door assembly. Set the outer door assembly aside.

Reverse the hinge and hinge cover

1. Place the inner door, screwhead side up, on the work space.
2. Gently pull the plastic cover out and down. This unsnaps the plastic hinge cover from the inside door assembly.

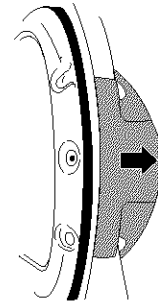

3. Remove the 4 screws that hold the hinge to the door.

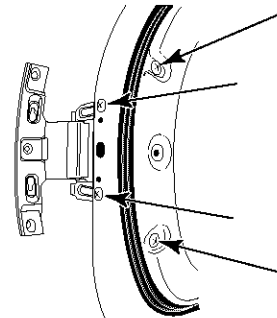

4. Reverse the 2 large hole screw plugs to the opposite side and insert in the original screw holes.

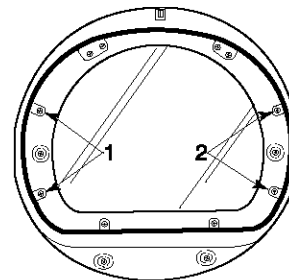

1. Hinge screws
2. Hole screw plugs

5. Move hinge to the other side and reattach.
6. Reverse the plastic cover. Slide it up over the inner door assembly edge and gently snap into place.

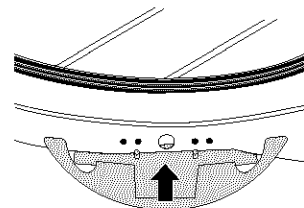

7. Set the inner door assembly aside.

Reverse the door handle

1. Place the outer door assembly face down on work space.
2. Remove the 2 screws that hold the door handle and the 2 screws holding the hole plugs. If hole plugs do not easily fall out after screws are removed, insert a small screwdriver into the holes and gently push the plugs out.

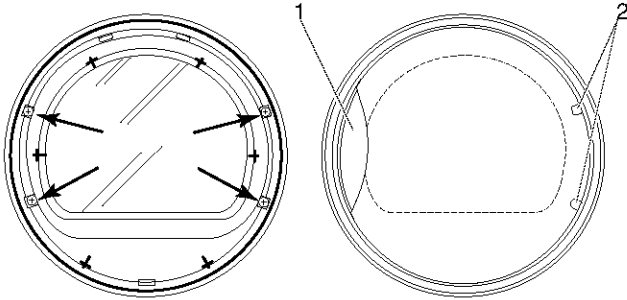

1. Door handle
2. Hole plugs

3. Move the door handle to the other side and reattach.
4. Move the hole plugs to the new hinge side and attach with screws.

Reinstalling the door

1. Check for fingerprints on the glass. Clean if necessary.
2. Place the inner door assembly into the outer door assembly. Align the hinge cover and hinge in the openings on each side. To fit correctly, the inside door assembly edge is completely inside the outside door assembly edge.
3. Reassemble the inner and outer door assemblies with the 6 screws.

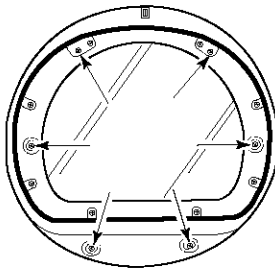

4. Use a small flat-head screwdriver to remove hole plugs in the door opening. Slide the head of the screwdriver under the cap of each hole plug, being careful not to scratch the dryer surface. Lift up. Remove the hole plugs in the door opening and insert in the opposite side.

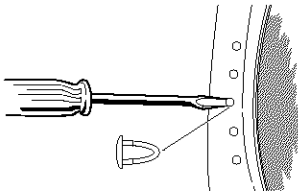

5. Insert a screw in the 2nd opening from the top of the hinge opening and partially tighten. Hang the door by placing the top hinge keyhole over the 2nd screwhead and tighten the screw. By putting this screw in first, the door will hang in place while you insert and tighten the remaining 4 screws.

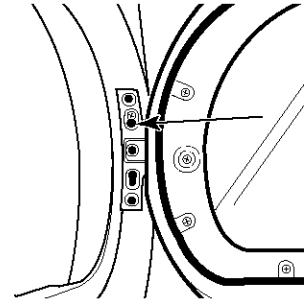

6. Close the door and check that it latches securely.

Complete Installation

1. Check to be sure all parts are now installed. If there is an extra part, go back through the steps to see which step was skipped.
2. Check to be sure you have all of your tools.
3. Dispose of all packaging materials.
4. Check the dryer's final location. Be sure the vent is not crushed or kinked.
5. Check to be sure the dryer is level. (See "Level Dryer.")
6. Plug into a grounded 3 prong outlet. Turn power on.
7. Remove the blue protective film on the console and any tape remaining on the dryer.
8. Read "Dryer Use."
9. Wipe the dryer drum interior thoroughly with a damp cloth to remove any dust.
10. Set the dryer on a full heat cycle (not an air cycle) for 20 minutes and start the dryer.

If the dryer will not start, check the following:

- Dryer is plugged into a grounded 3 prong outlet.
 - Electrical supply is connected.
 - House fuse is intact and tight; or circuit breaker has not tripped.
 - Dryer door is closed.
11. When the dryer has been running for 5 minutes, open the dryer door and feel for heat. If you do not feel heat, turn the dryer off and check to see if the gas supply line shutoff valve is open.
 - If the gas supply line shutoff valve is closed, open it, then repeat the 5-minute test as outlined above.
 - If the gas supply line shutoff valve is open, contact a qualified technician.

FEATURES AND BENEFITS

Automatic Temperature Control

In Auto Dry Cycles, the heat is automatically turned down as the clothes become dry. This allows faster drying, reduces overdrying and provides better care of the fabrics.

Jeans Cycle

The automatic temperature control monitors temperature and moisture and turns down the temperature at the right time. Jeans come out of the dryer ready to wear. You can put them on without them being damp or overdry.

Ultra Delicate

The Ultra Delicate drying system is Kenmore's fastest and gentlest drying combination ever. It allows an ultra low drying temperature without long drying times.

DRYER USE

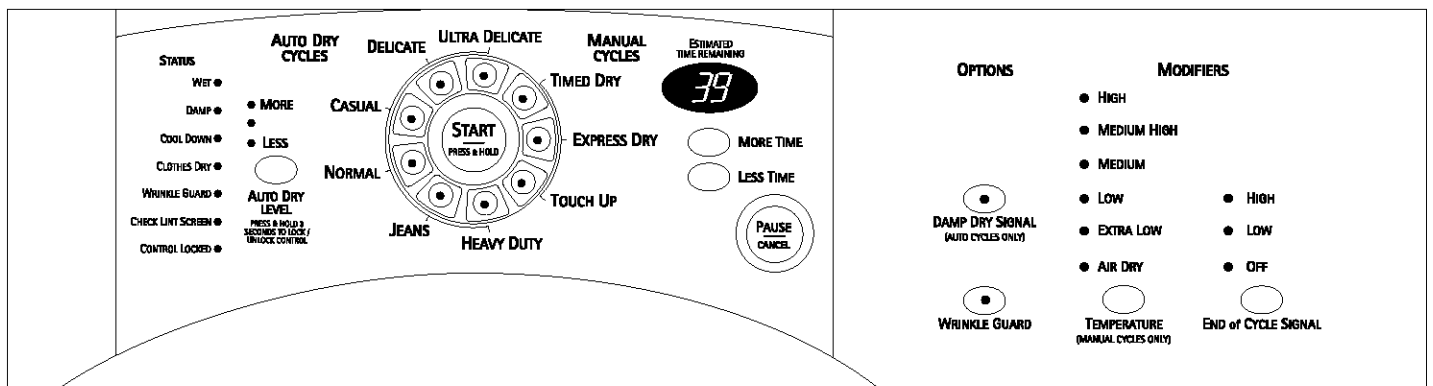

Starting Your Dryer

WARNING



Explosion Hazard

Keep flammable materials and vapors, such as gasoline, away from dryer.

Do not dry anything that has ever had anything flammable on it (even after washing).

Failure to follow these instructions can result in death, explosion, or fire.

WARNING



Fire Hazard

No washer can completely remove oil.

Do not dry anything that has ever had any type of oil on it (including cooking oils).

Items containing foam, rubber, or plastic must be dried on a clothesline or by using an Air Cycle.

Failure to follow these instructions can result in death or fire.

Follow these basic steps to start your dryer. Please refer to specific sections of this manual for more detailed information.

1. Clean lint screen before or after each cycle.
2. Place laundry into dryer and shut door. See "Loading."
3. Press the selected cycle pad. The preset settings for Auto Dry Cycles or Manual Cycles will glow. The estimated or actual cycle time (in minutes) will show in the display.

To use an Auto Dry Cycle

- Select an Auto Dry Cycle.
- Select AUTO DRY LEVEL to adjust how dry you want the load. As the cycle runs, the control senses the dryness of the load and adjusts the time automatically for the selected dryness level.
- Select the desired Options.

To make changes during an Auto Dry Cycle:

- Press PAUSE/CANCEL.
- Adjust Auto Dry Level and/or Options.

NOTE: Auto Dry Level selections can only be made while using Auto Dry Cycles. Selecting More or Less automatically adjusts the sensed time needed.



To use a Manual Cycle

- Select a Manual Cycle.
- Press MORE TIME or LESS TIME until the desired drying time is displayed. Tap MORE TIME or LESS TIME and the time will change by 1-minute intervals. Press and hold MORE TIME or LESS TIME and the time will change by 5-minute intervals.

NOTE: The More Time and Less Time features can only be used with Manual Cycles.



- Press TEMPERATURE until the desired temperature glows.

NOTE: During a Manual Cycle, you can change the settings for Time, Temperature, WRINKLE GUARD® and End of Cycle Signal. Press PAUSE/CANCEL twice to stop the dryer and clear the settings. Select another cycle or option.

- (OPTIONAL STEP) If desired, select OPTIONS. For more details, see "Options."
- (OPTIONAL STEP) If desired, set the END of CYCLE SIGNAL. Select HIGH or LOW to alert you when a cycle ends.
- Press and hold START for approximately 3 seconds until dryer starts. Be sure the door is closed.
 - If you do not press Start within 5 minutes of selecting the cycle, the dryer automatically shuts off.
 - If you wish to end your drying cycle after pressing Start, press PAUSE/CANCEL twice.

Stopping Your Dryer

To stop your dryer at any time

Press PAUSE/CANCEL twice or open the door.

Pausing or Restarting

To pause the dryer at any time

Open the door or press PAUSE/CANCEL once.

To restart the dryer

Close the door. Press and hold START until dryer starts.

NOTE: Drying will continue from where the cycle was interrupted if you close the door and press Start within 5 minutes. If the cycle is interrupted for more than 5 minutes, the dryer will shut off. Select new cycle settings before restarting the dryer.

Control Locked

This feature allows you to lock your settings to prevent unintended use of the dryer. You can also use the Control Locked feature to prevent unintended cycle or option changes during dryer operation.

To enable the Control Locked feature:

Press and hold AUTO DRY LEVEL for 3 seconds. Control Locked glows and a single beep tone is heard. To unlock, press and hold AUTO DRY LEVEL for 3 seconds. The indicator light turns off.

Loading

Properly loading your dryer can lower your utility bill and prolong the life of your garments.

Loading suggestions

- Load the dryer by the amount of space items take up, not by their weight.
- Do not overload the dryer. This causes uneven drying and wrinkling.

Super Capacity Dryers

Heavy Work Clothes

4 jeans	2 sweatpants
4 workpants	2 sweatshirts
4 workshirts	

Towels

10 bath towels	14 washcloths
10 hand towels	

Mixed Load

3 sheets (1 king, 2 twin)	9 T-shirts
4 pillowcases	9 shorts
3 shirts	10 handkerchiefs
3 blouses	

Drying and Cycle Tips

Select the correct cycle and dryness level or temperature for your load. If an Auto Dry Cycle is running, the display shows the estimated cycle time when your dryer is automatically sensing the dryness level of your load. If a Manual Cycle is running, the display shows the exact number of minutes remaining in the cycle.

Cool Down tumbles the load without heat during the last few minutes of all cycles. Cool Down makes the loads easier to handle and reduces wrinkling. The length of the Cool Down depends on the load size and dryness level.

Drying tips

- Follow care label directions when they are available.
- If you use fabric softener sheets, use only ones labeled as dryer safe. Follow package instructions.
- To reduce wrinkling, remove the load from the dryer as soon as tumbling stops. This is especially important for permanent press, knits, and synthetic fabrics.
- Avoid drying heavy work clothes together with lighter fabrics. This could cause overdrying of lighter fabrics and their increased shrinkage or wrinkling.

Cycle tips

- Dry most loads using the preset cycle settings.
- Refer to the Auto Dry or Manual Preset Cycle Settings chart (in the “Cycles” section) for a guide to drying various loads.
 - Drying temperature and Auto Dry Level are preset when you choose an Auto Dry Cycle. You can select a different dryness level, depending on your load by pressing Auto Dry Level and tapping More or Less.
 - If you wish to adjust the cycle length of a Manual Cycle, press More Time or Less Time. Adjust the temperature of a Manual Cycle by pressing Temperature until the desired temperature is selected.

NOTE: You cannot choose an Auto Dry Level with Manual Cycles.

Status Lights

Follow the progress of your dryer with the drying Status indicator lights.

- WET ●
- DAMP ●
- COOL DOWN ●
- CLOTHES DRY ●
- WRINKLE GUARD ●
- CHECK LINT SCREEN ●
- CONTROL LOCKED ●

Wet

The Wet light glows at the beginning of Auto Dry or Manual cycles if a wet item is detected.

- In an Auto Dry Cycle, if a wet item is not detected after 5 minutes, the dryer goes directly into Cool Down and the Cool Down and WRINKLE GUARD® indicators glow, if selected.
- In a Manual Cycle, if a wet item is not detected, the dryer will continue to run for the length of time selected, but the Wet light will not glow.

Damp

The Damp light glows in an Auto Dry Cycle when the laundry is approximately 80% dry. Damp Dry Signal beeps, if selected. (See “Options.”)

Cool Down

The Cool Down light glows during the cool down part of the cycle. Laundry cools for ease in handling.

Clothes Dry

The Clothes Dry light glows when the drying cycle is finished. This indicator stays on during WRINKLE GUARD®.

WRINKLE GUARD®

The WRINKLE GUARD® light glows when this option is selected. This indicator stays on with Clothes Dry.

Check Lint Screen

The Check Lint Screen light reminds you to check the lint screen. The light glows when the user selects a cycle. It goes out when the door is opened, Start is pressed, or until 5 minutes elapses.

Control Locked

The Control Locked light glows when this option is enabled.

Indicator lights

Other indicator lights show Cycle, Options, Modifiers and End of Cycle settings selected. The display shows the estimated or actual time remaining.

Cycles

Select the drying cycle that matches the type of load you are drying. (See Auto Dry or Manual Preset Cycle Settings charts.)

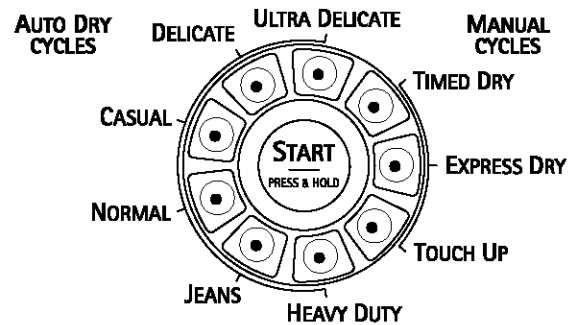

Auto Dry Cycles

Auto Dry Cycles allow you to match the cycle to the load you are drying. See the following “Auto Dry Preset Cycle Settings” chart. Each cycle dries certain fabrics at the recommended temperature. A sensor detects the moisture in the load and automatically adjusts the drying time for optimal drying.

Heavy Duty

Use this cycle to get high heat for heavy fabrics such as cotton towels or bedspreads.

Jeans

Use this cycle to get medium-high heat for drying denims.

Normal

Use this cycle to get medium heat for drying sturdy fabrics such as work clothes.

Casual

Use this cycle to get low heat for drying no-iron fabrics, such as sport shirts, casual business clothes and permanent press blends.

Delicate

Use this cycle to get low heat for drying synthetic fabrics, washable knit fabrics and no-iron finishes.

Ultra Delicate

Use this cycle to get extra low heat to gently dry items such as lingerie, exercise wear, or sheer curtains.

Auto Dry Preset Cycle Settings

Auto Dry Cycles Load Type	Temp.	Time* (Minutes)
HEAVY DUTY Heavyweight, towels	High	44
JEANS Denim pants, jackets	Medium High	54
NORMAL Corduroys, work clothes	Medium	41
CASUAL Permanent press, synthetics	Low	36
DELICATE Sheets, lingerie, blouses	Low	32
ULTRA DELICATE Exercise wear, sheer curtains, lace	Extra Low	22

* Estimated Time with Auto Dry Level (Normal) setting.

Manual Cycles

Use Manual Cycles to select a specific amount of drying time and a drying temperature. When a Manual Cycle is selected, the Estimated Time Remaining display shows the actual time remaining in your cycle. You can change the actual time in the cycle by pressing More Time or Less Time. (See "Changing Cycles, Options and Modifiers.")

Timed Dry

Use this cycle to complete drying if items are still damp after an Auto Dry Cycle. Timed dry is also useful for drying heavyweight and bulky items, such as bedspreads and work clothes.

EXPRESS DRY™

Use this cycle for drying small loads or loads that need a short drying time.

Touch Up

Use this cycle to remove wrinkles from items, such as clothes packed in a suitcase or items wrinkled from being left in the dryer too long.

Manual Preset Cycle Settings

Manual Cycles Load Type	Temp.	Default Time (Minutes)
TIMED DRY Heavyweight, bulk, bedspreads, work clothes	High	40
EXPRESS DRY™ Small loads	High	23
TOUCH UP Remove wrinkles	Medium High	20

Options

You can customize your cycles by selecting options.



DAMP DRY SIGNAL
(AUTO CYCLES ONLY)



WRINKLE GUARD

Damp Dry Signal

Select the Damp Dry Signal to alert you that your clothes are approximately 80% dry. This is useful when you want to remove lightweight items in a mixed load to prevent overdrying or remove partially dry items that may need ironing.

NOTE: The Damp Dry Signal is only available with the Auto Dry Cycles.

WRINKLE GUARD®

WRINKLE GUARD® prevents wrinkles that form when you cannot unload the dryer promptly at the end of a cycle. During this option, the dryer stops tumbling and then tumbles again for a brief period.

- Press WRINKLE GUARD® to get up to 2½ hours of heat-free, periodic tumbling at the end of a cycle.
- Stop WRINKLE GUARD® at any time by pressing WRINKLE GUARD® or opening the dryer door.
- For the Casual Auto Dry Cycle, WRINKLE GUARD® is preset to on. The other Auto Dry Cycles will retain the WRINKLE GUARD® setting. For example, if you select WRINKLE GUARD® in the Normal cycle, WRINKLE GUARD® will be on the next time you select the Normal cycle.

NOTE: If you do not select WRINKLE GUARD®, the dryer stops after cool down.

Modifiers

Use Modifiers to select temperatures for the Manual Cycles. Press Temperature until the desired temperature setting glows. Temperature modifiers cannot be used with the Auto Dry Cycles.

- HIGH
- MEDIUM HIGH
- MEDIUM
- LOW
- EXTRA LOW
- AIR DRY



TEMPERATURE
(MANUAL CYCLES ONLY)

Air Dry

Use the Air Dry Modifier for items that require drying without heat such as rubber, plastic and heat-sensitive fabrics. This chart shows examples of items that can be dried using Air Dry.

Type of Load	Time* (Minutes)
Foam rubber - pillows, padded bras, stuffed toys	20 - 30
Plastic - Shower curtains, tablecloths	20 - 30
Rubber-backed rugs	40 - 50
Olefin, polypropylene, sheer nylon	10 - 20

* Reset cycle to complete drying, if needed.

When using Air Dry

- Check to see that coverings are securely stitched.
- Shake and fluff pillows by hand periodically during the cycle.
- Dry item completely. Foam rubber pillows are slow to dry.

NOTE: Air Dry is not available with Auto Dry Cycles.

Changing Cycles, Options and Modifiers

You can change Auto Dry and Manual Cycles, Options and Modifiers any time before pressing Start.

- Three short tones sound if an unavailable combination is selected. The last selection will not be accepted.

Changing Cycles after pressing Start

1. Press PAUSE/CANCEL twice.
2. Select the desired cycle and options.
3. Press and hold START. The dryer starts at the beginning of the new cycle.

NOTE: If you do not press Start within 5 minutes of selecting the cycle, the dryer automatically shuts off.

Changing Options and Modifiers after pressing Start

You can change an Option or Modifier anytime before the selected Option or Modifier begins.

1. Press PAUSE/CANCEL once.
2. Select the new Option and/or Modifiers.
3. Press and hold START to continue the cycle.

NOTE: If you happen to press Pause/Cancel twice, the program clears and your dryer shuts down. Restart the selection process.

End of Cycle Signal

End of Cycle Signal

The End of Cycle Signal produces an audible sound when the drying cycle is finished. Promptly removing clothes at the end of the cycle reduces wrinkling.

- HIGH
- LOW
- OFF



Press END of CYCLE SIGNAL to adjust the sound level or turn off the signal.

NOTE: When WRINKLE GUARD® is selected and the End of Cycle Signal is on, a tone sounds every five minutes until the clothes are removed, or WRINKLE GUARD® ends.

TUMBLE FREE™ Heated Dryer Rack

The dryer rack is shipped in place in your dryer. Remove and discard any packing material before use.

Use the TUMBLE FREE™ Heated Dryer Rack for items that you do not want to tumble dry, such as sweaters. When you use the heated dryer rack, the heated air inside the dryer flows in a concentrated pattern to allow efficient and uniform drying. Use Timed Dry to select the desired time.

To use the heated dryer rack:

Do not remove the lint screen.

1. Open dryer door.

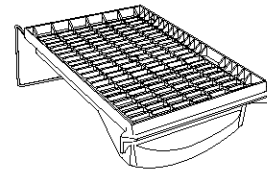

2. Place dryer rack over the bottom of the dryer door opening. Rest the back wire on the dryer back ledge. Push down on the frame front to secure over lint screen.

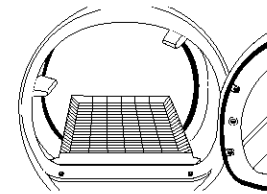

3. Place wet items on top of the rack. Allow space around items for air to circulate. The rack does not move, but the drum will rotate. Make sure items do not hang over the edges or between rack grille.

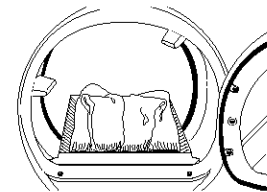

4. Close the door.
 5. Select TIMED DRY and MORE TIME or LESS TIME. Reset time as needed to complete drying. Refer to the following table.
 6. Select the desired temperature setting to match the fabrics in your load by pressing TEMPERATURE. Items containing foam, rubber, or plastic must be dried on a clothesline or by using the Air Dry temperature setting. Refer to the following table.
 7. Start the dryer.
- To remove the dryer rack, lift it straight up and out of the dryer.

NOTE: Check the lint screen and remove any lint accumulated from items dried on the rack.

Suggested Items for Rack Drying	Temperature Setting	Suggested Time* (Minutes)
Washable wool items (block to shape and lay flat on rack)	Low	20
Stuffed toys (cotton or polyester fiber filling)	Low	20
Stuffed toys (foam rubber filled)	Air Dry	50
Galoshes (rubber)	Air Dry	20
Foam rubber pillows	Air Dry	50
Tennis shoes	Air Dry	20

* Reset time as needed to complete drying.

DRYER CARE

Cleaning the Dryer Location

Keep dryer area clear and free from items that would obstruct the flow of combustion and ventilation air.

! WARNING



Explosion Hazard

Keep flammable materials and vapors, such as gasoline, away from dryer.

Place dryer at least 18 inches (46 cm) above the floor for a garage installation.

Failure to do so can result in death, explosion, or fire.

Cleaning the Lint Screen

Every load cleaning

The lint screen is located in the door opening of the dryer. Clean it before or after each load. A screen blocked by lint can increase drying time.

To clean

1. Pull the lint screen straight up. Roll lint off the screen with your fingers. Do not rinse or wash screen to remove lint. Wet lint is hard to remove.

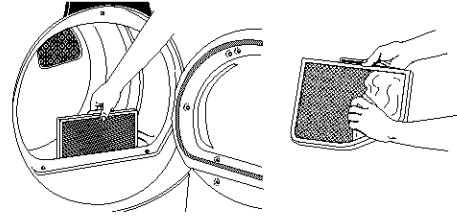

2. Push the lint screen firmly back into place.

IMPORTANT:

- Do not run the dryer with the lint screen loose, damaged, blocked, or missing. Doing so can cause overheating and damage to both the dryer and fabrics.
- Some towels made of synthetic fibers and natural fibers (polyester and cotton blends) may shed more lint than other towels, causing your dryer's lint screen to fill up faster. Be sure to remove lint from the lint screen before and after drying new towels.
- If lint falls off the screen into the dryer during removal, check the exhaust hood and remove the lint. (See "Venting Requirements.")

As needed cleaning

Laundry detergent and fabric softener residue can build up on the lint screen. This buildup can cause longer drying times for your clothes, or cause the dryer to stop before your load is completely dry. The screen is probably clogged if lint falls off the screen.

Clean the lint screen with a nylon brush every 6 months, or more frequently, if it becomes clogged due to a residue buildup.

To wash

1. Roll lint off the screen with your fingers.
2. Wet both sides of lint screen with hot water.
3. Wet a nylon brush with hot water and liquid detergent. Scrub lint screen with the brush to remove residue buildup.

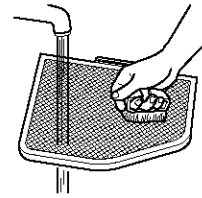

4. Rinse screen with hot water.
5. Thoroughly dry lint screen with a clean towel. Replace screen in dryer.

Cleaning the Dryer Interior

To clean dryer drum

1. Make a paste with powdered laundry detergent and very warm water.
2. Apply paste to a soft cloth.
OR
Apply a liquid, non-flammable household cleaner to the stained area and rub with a soft cloth until all excess dye is removed.
3. Wipe drum thoroughly with a damp cloth.
4. Tumble a load of clean cloths or towels to dry drum.

NOTE: Garments which contain unstable dyes, such as denim blue jeans or brightly colored cotton items, may discolor the dryer interior. These stains are not harmful to your dryer and will not stain future loads of clothes. Dry unstable dye items inside out to prevent dye transfer.

Removing Accumulated Lint

From Inside the Dryer Cabinet

Lint should be removed every 2 years or more often, depending on dryer usage. Cleaning should be done by a qualified person.

From the Exhaust Vent

Lint should be removed every 2 years, or more often, depending on dryer usage.

Vacation and Moving Care

Vacation care

Operate your dryer only when you are at home. If you will be on vacation or not using your dryer for an extended period of time, you should:

1. Unplug dryer or disconnect power.
2. Close shutoff valve in gas supply line.
3. Wash lint screen.

Moving care

1. Unplug the power supply cord.
 2. Close shutoff valve in gas supply line.
 3. Disconnect gas supply line pipe and remove fittings attached to dryer pipe.
 4. Cap the open fuel supply line.
 5. Make sure leveling legs are secure in dryer base.
 6. Use masking tape to secure dryer door.
-

Changing the Drum Light

The dryer light automatically turns on inside the dryer drum when you open the door.

To change the drum light

1. Unplug dryer or disconnect power.
 2. Open the dryer door. Locate the light bulb cover on the back wall of the dryer. Remove the screw located in the lower right corner of the cover. Remove the cover.
 3. Turn bulb counterclockwise. Replace the bulb with a 10-watt appliance bulb only. Replace the cover and secure with the screw.
 4. Plug in dryer or reconnect power.
-

TROUBLESHOOTING

First try the solutions suggested here and possibly avoid the cost of a service call...

Dryer displaying code message

- **“PF” (power failure), check the following:**
Was the drying cycle interrupted by a power failure? Press and hold START to restart the dryer.
 - **“E” Variable (E1, E2, E3) service codes:**
Call for service.
-

Clothes are not drying satisfactorily

- **Check the following:**
Is the lint screen clogged with lint?

Is the exhaust vent or outside exhaust hood clogged with lint, restricting air movement? Run the dryer for 5-10 minutes. Hold your hand under the outside exhaust hood to check air movement. If you do not feel air movement, clean exhaust system of lint or replace exhaust vent with heavy metal or flexible metal vent. (See “Installation Instructions.”)

Is the exhaust vent crushed or kinked? Replace with a heavy metal vent. (See “Installation Instructions.”)

Has a fuse blown, or a circuit breaker tripped?

Has an Air Dry cycle been selected? Select the right cycle for the types of garments being dried. (See “Cycles.”)

Is an automatic cycle ending early? The load may not be contacting the electronic sensor strips, level the dryer.

Is the valve open on the gas supply line?

Are fabric softener sheets blocking the grille? Use only one fabric softener sheet and only use it once.
 - **Is the dryer located in a room with temperature below 45°F (7°C)?**
Proper operation of dryer cycles requires temperatures above 45°F (7°C).
 - **Was a cold rinse water used? Was the load very wet?**
Expect longer drying times with items rinsed in cold water and with items that hold moisture (cottons).
 - **Is the load too large and heavy to dry quickly?**
Separate the load to tumble freely.
-

Dryer will not run

- **Check the following:**
Is the power cord plugged in?

Has a fuse blown, or has circuit breaker tripped?

Was a regular fuse used? Use a time-delay fuse.

Is the dryer door firmly closed?

Was Start firmly pressed and held for at least 1 second?

Is a cycle selected?
-

Unusual sounds

- **Has the dryer had a period of non-use?**
If the dryer hasn't been used for a while, there may be a thumping sound during the first few minutes of operation.

The gas valve clicking is a normal operating sound.

PROTECTION AGREEMENTS

Lint on load

- **Is the lint screen clogged?**
Clean lint screen. Check for air movement.
- **Is load properly sorted?**
Sort lint givers (towels, chenille) from lint takers (corduroy, synthetics). Also sort by color.
- **Is the load too big or too heavy?**
Dry smaller loads so lint can be carried to the lint screen.
- **Was the load overdried?**
Use correct dryer settings for load type. (See “Changing Cycles, Options and Modifiers.”) Overdrying can cause lint-attracting static electricity.
- **Was paper or tissue left in pockets?**
- **Is pilling being mistaken for lint?**
Pilling (surface fuzz) is caused by normal wear and laundering.

Stains on load or color change

- **Was dryer fabric softener properly used?**
Add dryer fabric softener sheets at the beginning of the cycle when the load is cold. Do not add fabric softener sheets to a warm load.
- **Were items soiled when placed in the dryer?**
Items should be clean before being dried.
- **Were items properly sorted?**
Sort light colors from dark colors. Sort colorfast items from noncolorfast items.

Items shrinking

- **Was the dryer overloaded?**
Dry smaller loads that can tumble freely.
- **Did the load overdry?**
Check the manufacturer’s care label. Match dryer setting to load type. (See “Cycles.”)

Loads are wrinkled

- **Was load removed from dryer at the end of the cycle?**
- **Was dryer overloaded?**
Dry smaller loads that can tumble freely.
- **Did load overdry?**
Check the manufacturer’s care label. Match dryer setting to load type. (See “Cycles.”)

Odors

- **Have you recently been painting, staining or varnishing in the area where your dryer is located?**
If so, ventilate the area. When the odors or fumes are gone from the area, re-wash and dry the clothing.

Garment damage

- **Check the following:**
Were zippers, snaps, and hooks left open?
Were strings and sashes tied to prevent tangling?
Were care label instructions followed?
Were items damaged before drying?

Master Protection Agreements

Congratulations on making a smart purchase. Your new Kenmore® appliance is designed and manufactured for years of dependable operation. But like all products, it may require preventive maintenance or repair from time to time. That’s when having a Master Protection Agreement can save you money and aggravation.

Purchase a Master Protection Agreement now and protect yourself from unexpected hassle and expense.

The Master Protection Agreement also helps extend the life of your new appliance. Here’s what’s included in the Agreement:

- ✓ **Expert service** by our 12,000 professional repair specialists
- ✓ **Unlimited service and no charge** for parts and labor on all covered repairs
- ✓ **“No-lemon” guarantee** – replacement of your covered product if more than three product failures occur within twelve months
- ✓ **Product replacement** if your covered product can’t be fixed
- ✓ **Annual Preventive Maintenance Check** at your request – no extra charge
- ✓ **Fast help by phone** – non-technical and instructional assistance on products repaired in your home, plus convenient repair scheduling
- ✓ **Power surge protection** against electrical damage due to power fluctuations
- ✓ **Rental reimbursement** if repair of your covered product takes longer than promised

Once you purchase the Agreement, a simple phone call is all that it takes for you to schedule service. You can call anytime day or night, or schedule a service appointment online.

Sears has over 12,000 professional repair specialists, who have access to over 4.5 million quality parts and accessories. That’s the kind of professionalism you can count on to help prolong the life of your new purchase for years to come. Purchase your Master Protection Agreement today!

Some limitations and exclusions apply. For prices and information call 1-800-827-6655.

Sears Installation Service

For Sears guaranteed professional installation of home appliances and items like garage door openers and water heaters, in the U.S.A. call **1-800-4-MY-HOME®**.



Get it fixed, at your home or ours!

Your Home

For repair – **in your home** – of **all** major brand appliances, lawn and garden equipment, or heating and cooling systems, **no matter who made it, no matter who sold it!**

For the replacement parts, accessories and owner's manuals that you need to do-it-yourself.

For Sears professional installation of home appliances and items like garage door openers and water heaters.

1-800-4-MY-HOME® (1-800-469-4663)

Call anytime, day or night (U.S.A. and Canada)

www.sears.com www.sears.ca

Our Home

For repair of carry-in items like vacuums, lawn equipment, and electronics, call or go on-line for the location of your nearest

Sears Parts & Repair Center.

1-800-488-1222

Call anytime, day or night (U.S.A. only)

www.sears.com

To purchase a protection agreement (U.S.A.) or maintenance agreement (Canada) on a product serviced by Sears:

1-800-827-6655 (U.S.A.)

1-800-361-6665 (Canada)

Para pedir servicio de reparación a domicilio, y para ordenar piezas:

1-888-SU-HOGARSM

(1-888-784-6427)

Au Canada pour service en français:

1-800-LE-FOYER^{MC}

(1-800-533-6937)

www.sears.ca

SEARS