

Owner's Manual of Pioneer® Energy Recovery Ventilator

PIONEER®

Applicable To Models:

- **ERV150AHRPM25L**



Contents

Table of Contents

Accessories List.....	1
Safety Remarks.....	2
Equipment Overview.....	3
Specifications.....	4
Operation Instructions.....	4
Wi-Fi Connection.....	8
Installation Instructions.....	10
Maintenance.....	13
Troubleshooting.....	15



Attention

Please read this manual carefully before installing or operating the equipment.
Be sure to save this manual for future reference.

Accessories List

Your purchase includes the following items. Please verify the following upon unboxing:











- 1x Ventilator Unit
- 1x Operation Manual

As well as the below listed parts:

			
1x Installation Panel	1x Power Cable	1x Remote Controller	2x PVC Straight Ducts
			
2x OA / EA Side/Back Cover	2x Air Vent Flange	1x Air Inlet Grille	1x Air Outlet Grille
			
2x Rain Proof Cover	2x Rubber Sealing Ring	2x Back Seal Ring	2x Side Sealing Ring
			
5x Knock-On Anchor Bolt	8x M3x6 Screws 8x M3 Nuts	4x Tapping Screws	Back Plate Insulation Foam

Safety Remarks

Please carefully read the following safety instructions prior to installation. Ensure that all steps are followed and that the unit is installed correctly. Please observe all precautions in order to avoid any injury or damage to equipment or property.

The following symbols indicate potential risk of harm to persons or property.		The following symbols indicate compliance which must be observed.	
	Situations with a risk of death or serious injury		Not Allowed/Stop Immediately
	Situations with a risk of injury or equipment damage.		Compliance Required
	Do not install the unit in a location that may be exposed to combustible gas leaks. If combustible gas accumulates around the unit, it may cause fire.		After installation, ensure that any unqualified persons do not try to move the equipment, to avoid risk of damage.
	Take care to prevent obstruction of the indoor outlet and return air inlet, so as to avoid fan or airflow abnormalities.		Be sure to turn off the power before performing any maintenance or coming into contact with any of the electrical components.
	Do not attempt to operate the machine with wet hands, especially any plugs or electrical parts.		It is required to use a properly grounded power supply. Improper ground wire connection may cause electric shock.
	Do not attempt to remove the motor or circuit board, to prevent electric leakage or discharge.		
	This product uses 110-120V ~ 60Hz power supply and a three-pin plug. Please use a suitable power supply.		When cleaning, use a clean soft cloth to wipe the machine, to avoid scratches.
	This product is intended for standard applications. If used in special circumstances, please first consult with the manufacturer.		For powering off, please use the touch screen controller. If not at home for a long time, please cut power to the system to maximize energy savings.
	Please follow the maintenance instructions in this manual: clean the return air filter and the entire heat exchanger regularly.		Install the product in an environment where humidity is less than 85%. Do not introduce fresh air in a hazardous environmental area. The fresh air outlet should be far away from kitchen ventilators, garbage dumps, pollution discharge outlets, and air conditioning outdoor units.
Replace the primary filter and HEPA filter regularly.			

Equipment Overview

Working Principle and Functionality

The wall mounted energy recovery ventilator integrates air purification and energy recovery. This product is made up of a supply fan, exhaust fan, heat exchanger, primary filter, medium filter, activated carbon filter, with a HEPA filter at the OA* side and a primary filter at the RA* side.

*Note, for Reference: OA = Outdoor Air EA = Exhaust Air RA= Return Air SA = Supply Air

The system has the following operating principles and benefits:

1. Fresh Air Purification: Outdoor air is pulled in by the supply fan and passes through the primary filter, where it will then exchange energy with the RA in the heat exchanger. The fresh outdoor air will then be further filtered by the HEPA filter, before finally being sent indoors. Meanwhile, the EA fan will exhaust stale indoor air outside, so as to improve and replenish the indoor air quality.

2. Energy Recovery: Typically the air temperature difference between indoor and outdoor is quite large. Therefore, when the indoor air is at a comfortable temperature and humidity, if fresh air is merely filtered before being introduced inside, then it will increase the burden on and thereby the power consumption of the air conditioning or heating system. In order to avoid this side effect, your new Pioneer® ERV system is equipped with a heat exchanger, which can recover the energy of EA, and then recycle to OA. This function will greatly reduce these energy losses, and works all year-round.

Dimensions (mm)

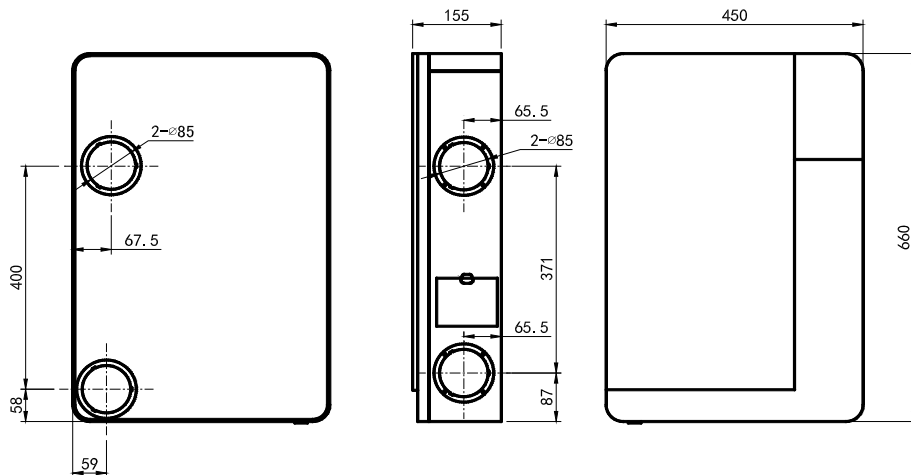

Specification and Operation Instructions

Technical Specifications

Model Number	ERV150AHRPM25L		
Airflow (CFM)	88		
Voltage (V)	110/120	IP Class	IPX2
Filtration Capacity (%)	99	Frequency (Hz)	60
Temp. Efficiency (%)	82	Noise dB(A)	36
Weight (Lb)	22	Input Power (W)	35
Serial Number	Located on the ventilator body	Dimensions WDH (in.)	17"-3/4 x 6"-1/8 x 26"

Display Screen Main Interface Overview

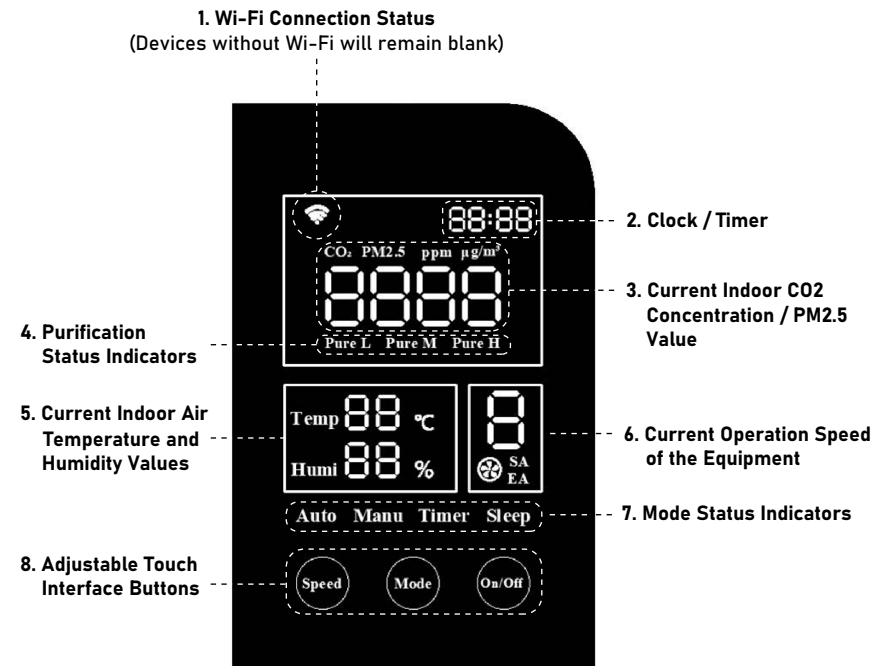

Operation Instructions

Overview of Control Buttons

- Press the "On/Off" button to turn on or off the machine.
- After startup, use the "Mode" button to switch modes as follows:



Auto > Manual > Timer > Sleep > PURE L > PURE M > PURE H

(Note: When the equipment first starts, the default is "Auto" mode)



- Under "Manual" mode, use the "Speed" button to select from speeds 1-8.



Operation Modes Overview

- In AUTO mode, the system will adjust supply air volume according to the indoor CO2/PM2.5 range, with the corresponding speed as follows:

CO2 Value	Air Quality Status	Operational Speed
$0 \leq CO2 \leq 450$	Excellent	1
$450 < CO2 \leq 1000$	Good	3
$1000 < CO2 \leq 1500$	Light Impurities	5
$1500 < CO2 \leq 2000$	Medium Impurities	7
$CO2 > 2000$	Serious Impurities	8

PM2.5 Value	Air Quality Status	Operational Speed
$0 \leq PM2.5 \leq 35$	Excellent	1
$35 < PM2.5 \leq 75$	Good	2
$75 < PM2.5 \leq 115$	Light Impurities	4
$115 < PM2.5 \leq 150$	Medium Impurities	5
$150 < PM2.5 \leq 250$	Heavy Impurities	7
$PM2.5 > 2000$	Serious Impurities	8

Note: To ensure sufficient indoor fresh air supply, the speed will rise automatically after model "Auto" runs for some time. After 5-10 minutes, it will revert to the previous speed. During this time, the screen will display a different speed from the above chart.

Operation Instructions

- Under any mode, the unit will be switched to "Manual" mode when the user presses the "Speed" button. Pressing "Speed" again allows configuration of the SA/EA fan speed. When "SA" flashes, use "Speed" button to set SA fan speed from speeds 1-8. Pressing "Mode" switches to "EA" fan setting. When "EA" flashes, pressing "Speed" configures the fan to speeds of 1-8. Once finished, press "Mode" to save and exit, otherwise the system will automatically save and exit after 15s.
- "TIMER" mode will be configured via the handheld remote controller.
- With "SLEEP" mode, the system runs at the lowest speed, and the screen brightness will be lowered to half of the normal setting.
- Modes "PURE L", "PURE M", and "PURE H" are for rapid improvement of the indoor air quality, with L/M/H being Low/Medium/High. The speed of performance can be configured as needed.

Button Combinations

Combinations	Result
(Ventilator is ON) Long pressing "On/Off" + "Speed" together	1. Reset Wi-Fi 2. Clear connection information
(Ventilator is either ON or OFF) Long pressing "On/Off" + "Mode" together	Reset to Factory default setting
(Ventilator is OFF) Long pressing "On/Off"	Set RS485 address

Operation Instructions

Remote Controller Overview

Button Functions:

1. Pressing "On" turns on the ventilator.
2. Pressing "Off" turns off the ventilator.
3. Pressing "Lock" turns off the display, (Pressing again turns on the display).

Time Setting:

4. Pressing the "Hour" button will make the "Hour" part at the top right corner of the ventilator screen begin blinking. Pressing "+" will increase time, pressing "-" decreases time. Pressing the "Hour" button will save the setting and exit hour-setting mode.
5. Pressing the "Minute" button will make the "Minute" part at the top right corner of the ventilator screen begin blinking. Pressing "+" will increase time, pressing "-" decreases time. Pressing the "Minute" button will save the setting and exit minute-setting mode.

Note: When blinking, if there is no operation in 15s, the blinking will end and settings will be saved automatically.

6. Pressing "+" changes the fan speed from slower to faster, and pressing "-" changes the fan speed from faster to slower (Except for when adjusting time, or when the system is shut down). When in "MANUAL" mode, the SA indicator will flash, and pressing the "+" or "-" buttons will adjust the SA speed. After configuring SA speed, pressing "Pure H" will switch to air speed selection of EA. (During this step, the "Pure H" button functions as the "Mode" button). Pressing "+" or "-" will adjust the air speed.

After configuring the EA speed, pressing the "Pure H" button once more will quit the speed configuration (or automatically when no input is received for 15s). The air speed of SA and EA will be saved accordingly.

7. Pressing the "Sleep" button yields the same results that are described on Page 6.
8. Pressing the "Auto" button yields the same results that are described on Page 6.
9. Pressing "Timer" will enter Timer Mode, and the time shown at the top right corner of the machine screen will begin blinking. Pressing "+" increases time and "-" decreases time, in interval of 30 minutes. The longest time setting is 8 hours, and the default time setting is 00:00. Pressing "Timer" once more will save and exit the timer setting, and the top right corner of the ventilator screen will revert to displaying the current time again.

Note: When blinking, if there is no input for 15s, the blinking will end, and settings saved automatically. Once timer setting is completed, pressing the "Timer" button at top right corner of the display will display the remaining time for the timer setting. At this time the timer can be set again, if needed.

To cancel the timer function, set the time to 00:00.

10. Pressing the "Pure L/M/H" buttons yields the same results that are described on Page 6.

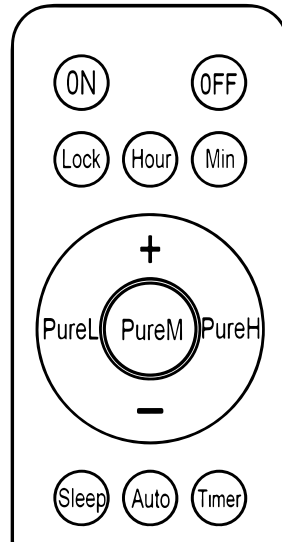

Wi-Fi Connection

Installation of "Pioneer Airlink" smartphone application

Search for "Pioneer Airlink" in the Google Play Store (for Android users) or the App Store (for iOS users). Note that a 2.4GHz Wi-Fi connection is needed to use the Wi-Fi control feature.



Or, scan the below QR code to download the app from the respective app store.



Download Android App



Download iOS App

Wireless Control App Setup Process

1. Registration and Log-In:

If you do not already have a "Pioneer Airlink" account, please create an account and log-in by following the below steps:

- i. Approve the "User Agreement" and "Privacy Policy" when they appear by tapping "I Agree".
- ii. Tap the "Sign Up" button, choose your country, and enter your mobile number/e-mail to register, tick "I Agree" on "User Agreement and Privacy Policy", then tap the "Get Verification Code" button. The phone or e-mail that you're registering will receive a registration verification code.
- iii. Enter the verification code and select a password. You will then either land on the homepage of the App, or back to the login interface to log into the app, by using the account you just created.

2. Adding a New Device:

- i. Confirm that your phone is connected to Wi-Fi (2.4GHz networks only, 5GHz will not work). Tap the "+" at the top-right corner of the homepage, to enter the device selection page.
- ii. Once you've entered this page, head to your Pioneer ERV system and long press "On/Off + Speed" buttons when the ventilator is turned ON, until the Wi-Fi symbol on the display screen flashes. (Fast flashing indicates Wi-Fi connection, slow flashing refers to hotspot network.)

Wi-Fi Connection

- iii. Select the "Small Home appliance" category, and scroll downward to locate the "Ventilation System (Zigbee)" icon, as shown below. After selection, follow the on-screen instructions step by step, until the system is successfully paired. Double-check that the data being entered (such as Network passwords) is accurate.





Ventilation System
(Zigbee)

3. Basic Control Overview

Once connected, navigate to the homepage of device in the App. Tapping the "On/Off" button modifies the operating status of the ventilator. Tapping the "Speed" button adjusts the airflow.

(Different models may have some variation or different operations).

4. Modify the System's Name

- i. Tap the icon  at the upper right corner in the homepage to enter into the settings menu.
- ii. Tap the icon  to enter the setting interface, tap the "Name" button to enter your desired name, then tap the "Save" button to save the system's new name.

5. Device Authorization and Device Sharing

- i. The primary user paired to the device must enter the settings menu (as instructed in "4. Modify the System's Name"), then tap "Device Sharing" to open the sharing prompt.
- ii. Once in the sharing prompt, enter the account number that you want to share access to the equipment to, and click "Done".
- iii. The shared user account will then appear on the menu if the sharing process was successful.

6. Device Deletion (Unbinding)

- i. Enter into the settings menu (as instructed in "4. Modify the System's Name"), then tap on "Device Removal".
- ii. Tap on "Remove Binding", followed by "Confirm". The system will then be unbound.

7. User Information Modification

- i. Tap the "I" on the bottom right corner of the homepage.
- ii. Tap on the picture area to enter the user information page.
- iii. Once inside the user information page, you can all modify user information, including avatar, username (nickname, account number, and security, etc.).

8. Signing Out

- i. Tap on "Me" on the bottom right corner of the homepage, then tap the "setting" button.
- ii. Select "Sign Out" at the bottom to logout from the app.

Installation Instructions

Energy Recover Ventilator Installation

Choose a suitable installation location for where the unit will ultimately reside, selecting from either the rear or side of the equipment for the air inlets and outlets.

Follow the installation steps for the selected face (rear or side) as given below:

Scenario 1: Rear Installation

1. Choose a suitable location on the wall where the equipment will be mounted, and mark where the OA inlet and EA outlet locations will be. Also mark the 5 mounting holes of the installation panel on wall.

Note on clearances:

- Ventilator bottom to the floor around 5 feet (1.5 meters)
- Ventilator left and right side to the wall no less than 1 foot (0.3 meter)

2. Drill 2 holes in the wall for the fresh air inlet and exhaust air outlet, each with a diameter of 4 inches.

The 2 holes should angle downward toward the outside to prevent rain water ingress, with a minimum downward slope of 1/4 inch per foot (18mm per meter). For the 5 mounting holes, recommended size is 1/4" drill bit and 2-3/4 in. deep hole (Φ6x70mm). Insert the 5 plastic anchors into the mounting holes.

Note: The OA inlet and EA outlet hole sizes is given according to the Pioneer accessories (straight PVC pipes). If your piping is of a different size than what is included, ensure the wall holes are matched accordingly.

3. Fasten the flange to the installation panel, using the included M3x12 bolts+nuts.

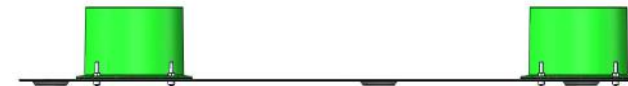

4. According to the thickness of the wall, cut the suitable length of the PVC pipes. Connect the PVC pipes to the OA and EA accessories as follows:

- **OA side:** PVC pipe + Air inlet grille + Rain proof cover + Rubber sealing ring + Tapping screws
- **EA side:** PVC pipe + Air outlet grille + Rain proof cover + Rubber sealing ring + Tapping screws

Note: Before installing the fastening screws, it is necessary to drill holes of Φ 1/8" (3mm).

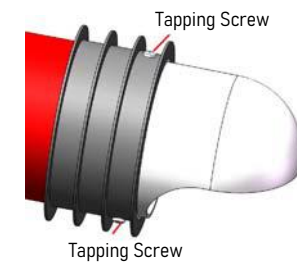
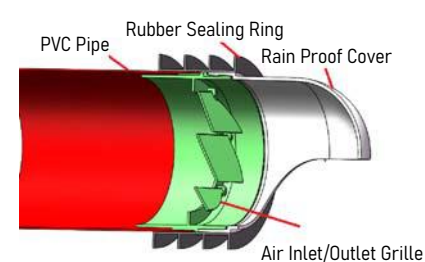

Installation Instructions

5. Slide the assembled ducts into the wall. Ensure that the rain cover is appropriately oriented downwards, to prevent rainwater ingress.

Next, seal any gaps between the duct and the wall, if present, using appropriate field-supplied materials like silicone or waterproof putty.

Seal any gaps

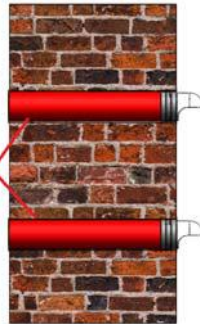

6. Secure the ERV installation panel onto the wall, by using the supplied knock-on anchor bolts.

7. Since the above installation is for the "Rear Installation Scenario", cut the EPS "Rear Cover" located at the OA vent, as shown in the below picture. **DO NOT cut the EPS "Side Cover" in this case.**

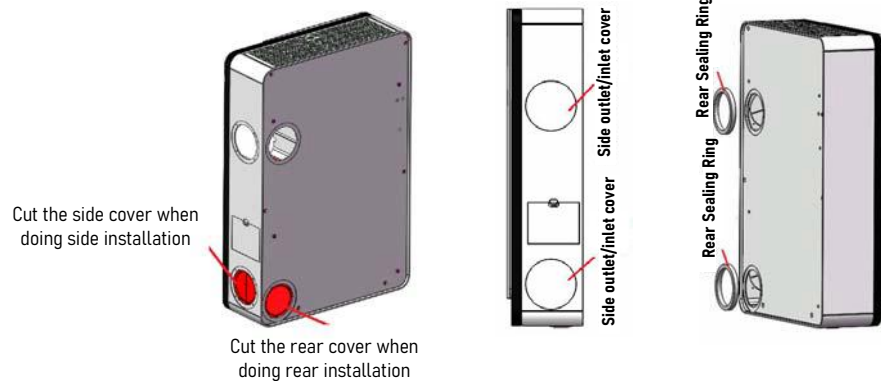

8. Place the 2 round OA and EA Side/Back covers on the side of the ventilator, to cover up the Side Air Inlet and Side Outlet (as shown above). Secure the 2x seal rings to the rear of the air inlet + outlet.

9. Secure the rear plate thermal insulated cotton/foam onto the rear side of the ventilator if necessary (near the OA side). This assists with preventing condensate water when the ventilator is deployed in cold areas.

10. Hang the ventilator onto the installation panel. Adjust the 4 pieces M5x18 hanging screws on the back of the ventilator to suit the installation panel.

11. Once installation is completed, power on the ventilator.

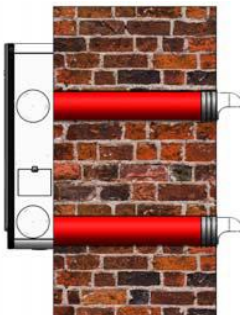

Installation Instructions

Scenario 2: Side Installation

1. Secure the 2x sealing rings on to the side flanges. Fasten the flanges to the ventilator side using the included 8x M3 bolts & 8pcs M3 nuts. Use caution to prevent dropping hardware into the ventilator during installation.

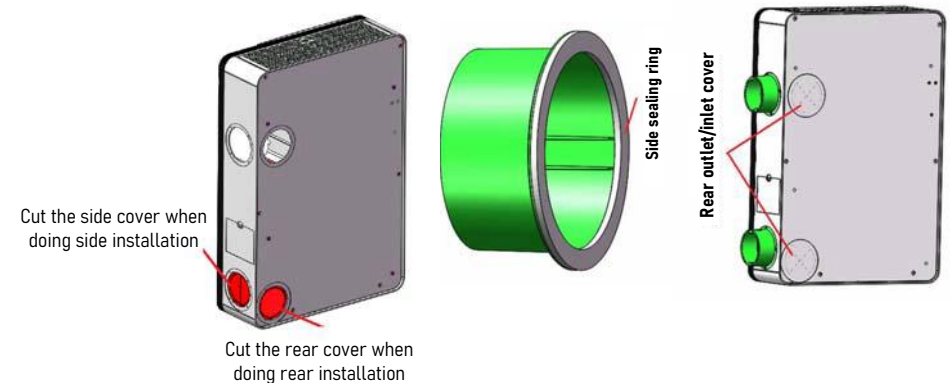

2. Since the above installation is for the "Side Installation Scenario", cut the EPS "Side Cover" located at the OA vent, as shown in the above picture. **DO NOT cut the EPS "Rear Cover" in this case.**

3. Choose a suitable location on the wall where the equipment will be mounted, and mark where the OA inlet and EA outlet locations will be. Also mark the 5 mounting holes of the installation panel on the wall according to the ventilator placement.

Note on clearances:

- Ventilator bottom to the floor around 5 feet (1.5 meters)
- Ventilator left and right side to the wall no less than 1 foot (0.3 meter)

4. For the 5 mounting holes, recommended size is 1/4" drill bit and 2-3/4 in. deep hole (Φ6x70mm). Drill the holes with reference to the panel, and insert the 5 plastic anchors into the mounting holes.

5. Drill 2 holes in the wall for the fresh air inlet and exhaust air outlet, each with a diameter of 4 inches.

The 2 holes should angle downward toward the outside to prevent rain water ingress, with a minimum downward slope of 1/4 inch per foot (18mm per meter).

Note: When drilling outlet holes on the wall, the opening hole size is only a recommended value. When installing the ventilator by the "Side Installation Scenario", the ducts should be flexible ducts (field supplied by the installer). The final hole size on the wall should be selected by the installer, according to the diameter of duct to be used.

Installation and Maintenance

- Hang the ventilator onto the installation panel. Adjust the 4 pieces M5x18 hanging screws on the back of the ventilator to suit the installation panel.
- According to the thickness of the wall, cut the suitable length of the PVC pipes. Connect the PVC pipes to the OA and EA accessories as shown on Page 10.
- Slide the assembled ducts into the wall. Ensure that the rain cover is appropriately oriented downwards, to prevent rainwater ingress. Next, seal any gaps between the duct and the wall, if present, using appropriate field-supplied materials like silicone or waterproof putty.
- Secure the other end of the installed piping onto the flanges on the side of the ventilator.
- Once installation is completed, power on the ventilator.

OA and RA Primary Filter Maintenance and Change

Attention: Power must be cut off to the device before attempting any maintenance. Wait for the machine to come to a complete stop, to avoid any injury.

The OA Primary and Medium Filters are located at the side of the ventilator. The RA Primary Filter, used to filter large particles in the air, is found at the bottom of the ventilator (as depicted in the illustration to the right).

- Open the filter covers according to the marked locations on the ventilator, and remove the primary and medium filters.
- The OA Medium Filter is not re-usable. It is advised to replace this filter every 1-2 months for best results.
- The OA and RA Primary Filters are washable and re-usable. It is recommended to replace these every 3-4 months.

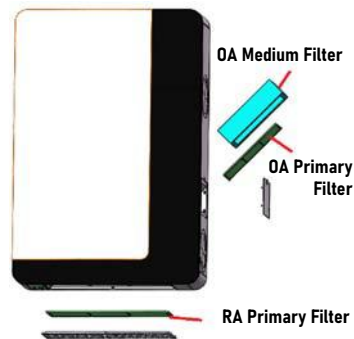

HEPA Filter Change

The HEPA Filter is located at the top of the ventilator, as depicted in the illustration to the right. It is used to filter smaller particles of less than 2.5µm from the air.

- Remove the covers at the marked locations on the ventilator. Remove the HEPA Filters and insert the replacement ones.
- It is recommended to change out the HEPA Filters every 8-12 months (based on the area) for best results.

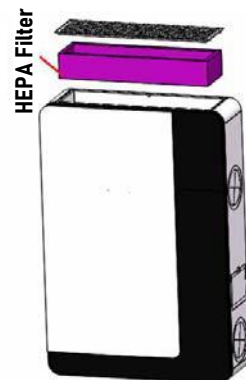

Maintenance

Maintenance of the Heat Exchanger

The plate heat exchanger is found in the central-right area of the ventilator, and is an air-to-air type heat exchanger. Its function is to keep fresh air and exhaust air separated, ensuring cleanliness and purity of the fresh air, as well as effectively preventing any cross-contamination.

- Remove the ventilator from the wall. Unscrew the 6 separate long screws from the rear side of the ventilator, and unscrew the access door. You can then remove the plate heat exchanger.
- Use a strong vacuum cleaner to remove any dust and dirt buildup from the heat exchanger.
- It is recommended to perform maintenance and cleaning of the exchanger every 3 years.
- For further maintenance queries, please contact the manufacturer.

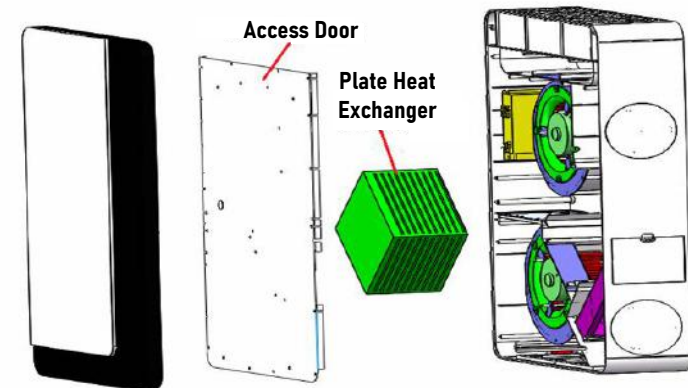

Maintenance of PM2.5/C02 Sensor

In order to prevent buildup and blockage of the air quality sensor, the sensor needs to be cleaned regularly.

- Remove the bottom grid, then locate and remove the Return Air Primary Filter. Refer to the illustration on the right for locating the filter.
- Use a hair dryer or air duster to clean the sensor. (If using the hair dryer, use the "fan-only" setting.)



Maintenance of Motor and Controller

To be performed by trained and qualified personnel only. Do not attempt as a homeowner. Contact the manufacturer with any questions.

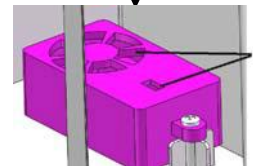

Troubleshooting

Users can often perform basic self-troubleshooting using the below chart, in the case of any faults or malfunctions.

Abnormality	Possible Causes	Solutions
The display does not start up	<ol style="list-style-type: none"> Loose or bad contact of power plug Power cable fault Display fault 	<ol style="list-style-type: none"> Check whether the plug is loose, and if so, reconnect it. Replace the power cable with one of same specification. Contact the manufacturer for a replacement or repair part.
No display or wrong display of temperature, humidity, or CO2 values	<ol style="list-style-type: none"> Sensor short circuit, or open circuit 	<ol style="list-style-type: none"> Contact manufacturer for service or suggestions.
The PM2.5/CO2 value displays abnormally, or doesn't display at all	<ol style="list-style-type: none"> The PM2.5/CO2 sensor test probe is covered by dust or debris Sensor short-circuit, or open-circuit 	<ol style="list-style-type: none"> Follow the PM2.5/CO2 sensor maintenance method in the manual to clean the sensor. If not resolved, contact the manufacturer for service.
Abnormal Noises	<ol style="list-style-type: none"> Poor fastening of the machine ducting Foreign matter entering the ventilator Fault of supply fan or exhaust fan. 	<ol style="list-style-type: none"> Adjust or secure the ducting. Contact manufacturer for repair parts or replacements.
Insufficient Fresh Air	<ol style="list-style-type: none"> Blockage at the Air Inlet/Outlets by foreign matter. Blockage of Primary or HEPA filter. 	<ol style="list-style-type: none"> Locate and clear out any observed foreign matter. Clean or replace the filters.
Excess particles at the supply air outlet	<ol style="list-style-type: none"> Overuse of Primary and/or HEPA filters 	<ol style="list-style-type: none"> Replace the affected filters.
No response to the fan speed adjustment switch (Code: E0, E1, E3)	<ol style="list-style-type: none"> No feedback from Supply and/or Exhaust Fan Other fan fault Main control board fault 	<ol style="list-style-type: none"> Contact manufacturer for repair suggestions. Contact manufacturer for fan replacement parts.

Exclusions to the Limited Warranty Disclosure

The following situations and scenarios are not covered by the limited warranty:

- Sabotage during usage that is considered man-made and/or intentional.
- Malfunction due to usage, maintenance, or repair that were not performed in accordance with the instructions of this manual.
- Damages caused by any force majeure.

Contact Information

The design and specifications of this product are subject to change without prior notice as development continues. Consult with the sales agency or manufacturer for details. Refer to the equipment nameplate for all other applicable specifications.



is a registered trademark of Parker Davis HVAC International, Inc.

Parker Davis HVAC International, Inc.
 3250 NW 107 Avenue, Doral, FL 33172 - USA
 Tel : (305) 513-4488
 Fax : (305) 513-4499
 E-mail : info@pdhvac.com
 Website : www.pdhvac.com

Pioneer product line, parts, and supplies are available online for convenient ordering at:
www.highseer.com
www.pioneerminisplit.com

Scan the below code to visit our support page where you can find more installation materials:



Copyright 2024, Parker Davis HVAC International, Inc., All rights reserved.