



A M C R E S T

Digital Video Recorder

Quick Start Guide

Version 1.0.0.
Revised October 12th, 2018

1. Front/Back Panel Diagrams & Descriptions.....	4
Front Panel	4
2. Front/Back Panel Diagrams & Descriptions.....	4
Rear Panel	4
3. Hardware Setup.....	5
Hard drive installation	10
4. Console Setup.....	12
5. Motion Detection & Recording Setup.....	21
Setting up motion detection and email alerts	26
6. Computer Access Setup.....	33
Amcrest IP Config Software method	34
Built-in interface method.....	37
Web Interface Walkthrough	47
7. Amcrest View App Setup.....	48
Enabling P2P on the DVR	48
App setup not working? (troubleshooting steps)	52
Amcrest View Pro interface overview	53
8. Amcrest View Web Portal Setup	54
Installing the AmcrestView.com browser plugin	54
User method	57
AmcrestView Web Interface Overview	66
9. References & Contact Information	69
FCC Statement.....	70
IC Warning Statement	70

Welcome

Thank you for purchasing our DVR!

This quick start guide will help you become familiar with our DVR in a very short time.

Before installation and operation, please read the below safeguards and warnings carefully.

Many of the setup sections below have corresponding videos on YouTube. To access the setup videos, please go to <http://amcrest.com/videos>



Note: This guide is applicable to all 4, 8, and 16 channel S5 and H5 model Amcrest DVRs, including XVRs. Some images and setup features may differ model to model.

Important Safeguards and Warnings

- All installations and operations here should conform to your local electrical safety codes.
- We assume no liability or responsibility for any of the fires or electrical shocks caused by improper handling or installation.
- We are not liable for any problems caused by unauthorized modifications or attempted repair.
- Improper battery use may result in fire, explosion, or personal injury.
- When replacing the battery, please make sure you are using the same model.

Check Packaging

When you receive the DVR system in the packaging, unpack it, and check all sides of the DVR to see if there is any physical damage. The protective materials used for the packaging of the DVR can protect most accidental damage during transportation, but to ensure that your equipment is operating as expected, it is recommended to inspect the product before proceeding further.

On the DVR unit, check specifically that the label on the bottom of the DVR is not damaged. The serial number of the unit is often needed to provide support.

Please check that all required items for your DVR are present and accounted for. To check what is included with your purchase, go to <http://amcrest.com/ip-security-camera-systems.html/> and find the product you purchased, then scroll down and click the "What's Included" tab. If any item is missing, please contact us as soon as possible so we can send you the missing components.

1. Front/Back Panel Diagrams & Descriptions

Front Panel

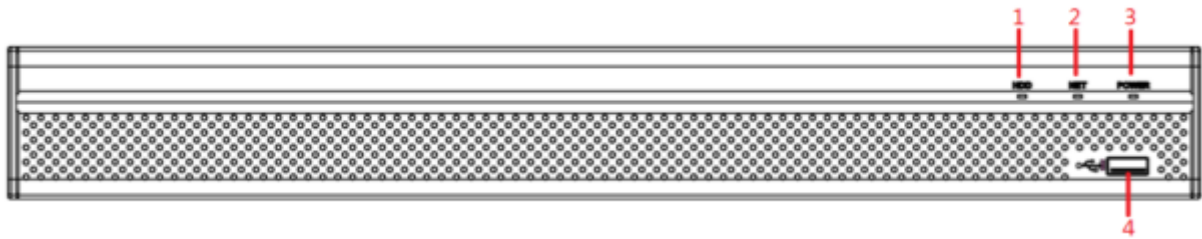

Please refer to the following chart for information on the front panel buttons.

SN	Icon	Name	Function
1	NET	Network abnormality indicator light	When a network error occurs or there is no network connection, this light turns red.
2	PWR	Power indicator	When DVR is on, this light remains on.
4	HDD	HDD abnormal indicator light	When an HDD error occurs, or the HDD capacity is below the specified threshold value, this light turns red.
5		USB 2.0 Port	USB 2.0 port: connect a mouse, USB storage device, etc.

2. Front/Back Panel Diagrams & Descriptions

Rear Panel

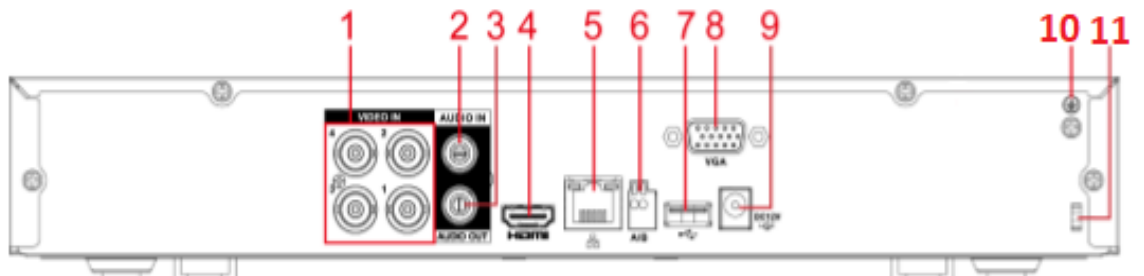

Please refer to the following chart for detailed information on the rear panel ports:

	Port Name	Function
1	Video input port	Connects to analog camera to input video signal.
2	Audio input port	Receives audio signal output from an RCA microphone DVR.
3	Audio output port	Outputs audio signal to an external RCA speaker.
4	HDMI port	High definition audio and video signal output port. The port outputs an uncompressed high-definition feed as well as multi-channel audio data to a connected HDMI compatible display.
5	Network port	Connects to Ethernet port.
6	RS485 communication port	Connects to control DVRs such as, speed dome PTZ cameras. The RS485_A port will be connected by a cable (A) and RS485_B (B) cable.
7	USB port	Connects to an external DVR such as, a mouse, keyboard, or external USB storage DVR.
8	VGA port	Outputs analog video data to a connected display with a compatible VGA port.
9	Power input port	Inputs DC 12V power.
10		Ground terminal.
11	Power cable fastener	Use a clamp to secure the power cable on the DVR to avoid signal error.

3. Hardware Setup

Before setting up the DVR, you will probably need the following items. The items are not included:

- A computer monitor or TV with either an HDMI or VGA input
- A power strip with room for 4 large power plugs

It is recommended to connect all components of the system as shown below *before* mounting any of the cameras. This is to ensure all components are working. If any components are not functioning, please contact Amcrest Support.

Setting up the cable connections

The following instructions will show you how to set up the cables for the DVR, cameras, as well as a monitor or TV screen.

To set up the DVR's cable connections, there are 7 major steps:

1. Connect a monitor or TV screen to your DVR. The DVR is compatible with any monitor or screen that uses a VGA or HDMI connection. For purposes of this guide, we will use a VGA connection. Take a VGA cable, and connect one end to the VGA port on your monitor/screen and the other end to the VGA port on the back panel of your DVR.

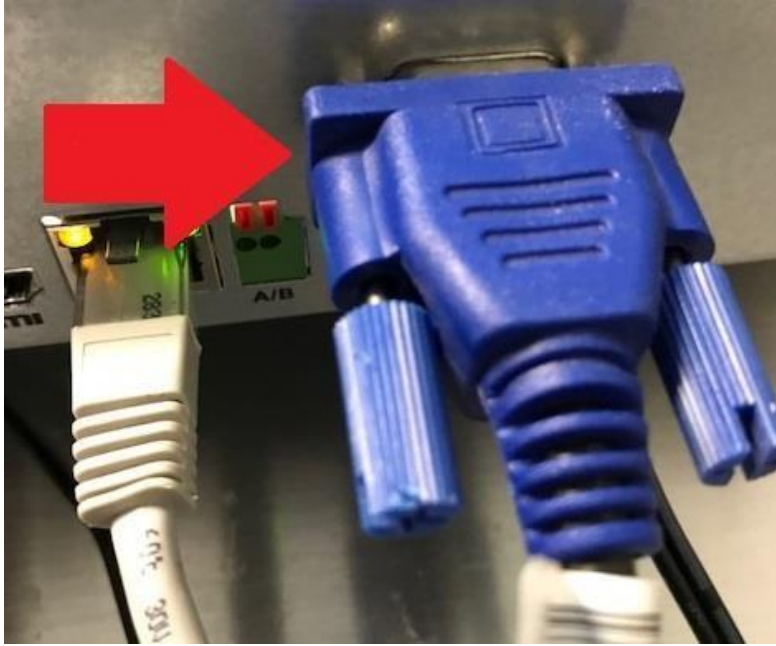

2. Connect a USB mouse (included) to the front of the DVR.



3. Connect an Ethernet cable to your router.

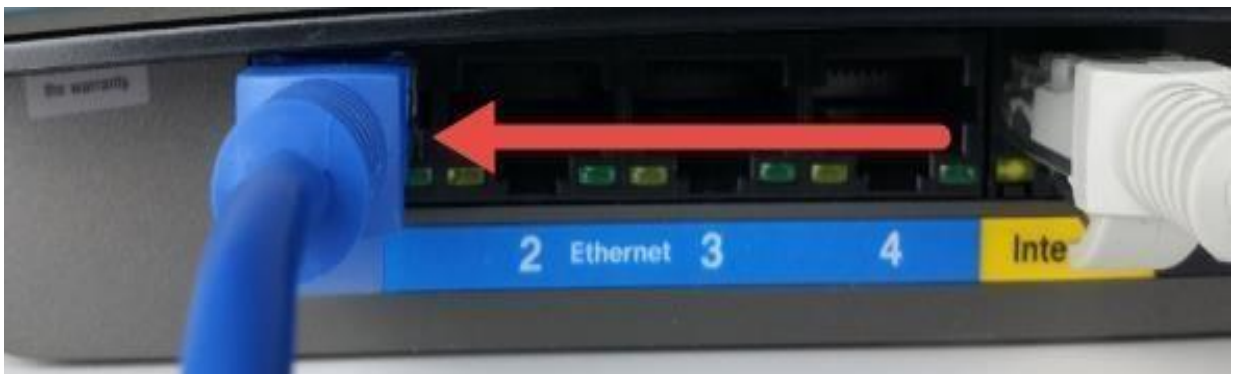

Then, connect the other end of the cable to the DVR.



4. Connect the camera video extension cable to the camera's video cable and connect the camera power extension cable to the camera's power cable. There should be a tag on the video cable to help you make sure the right end of the cable is at hand.



5. Connect the camera cable to any of the video input (coaxial) ports on the DVR.



6. Connect the camera power extension cable to one of the camera power cables, connect this power cable into the power brick, and then plug the cable into an electrical socket.

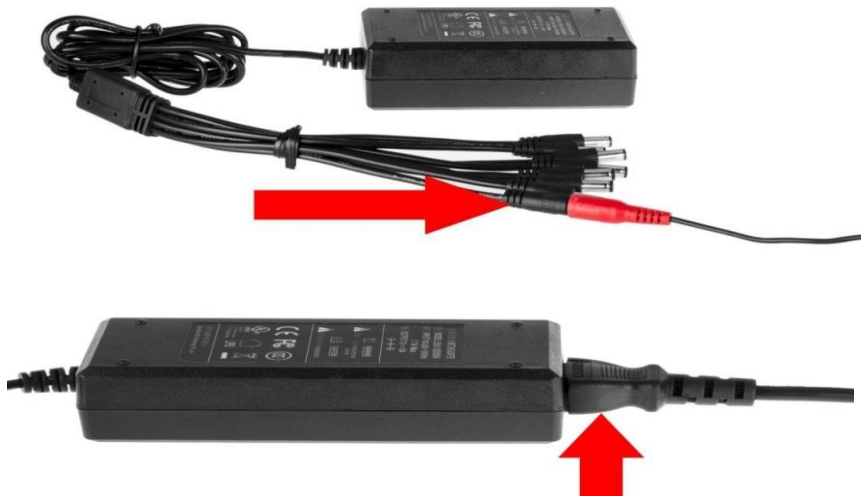

7. Connect the DVR power cable into the back of the DVR, and then plug in the DVR power adapter into an electrical socket.



- PLEASE READ BELOW-

Note: Your DVR may not work properly if the following is not accounted for.

Every single DVR comes preset to a video output resolution of **1280x1024**. What this means is that any time an HDMI cable is plugged into an HDTV, it may result with a blank screen even if the DVR is operational.

If this occurs, please follow the steps below.

Procedure using a VGA cable:

1. Connect your DVR to a computer monitor or TV screen with a VGA cable (the HDMI cable should not be connected during this process).
2. Boot up your DVR. On the monitor or TV, please make sure the "input" is set to VGA.
3. When the interface loads, you will see the login screen appear. Enter your credentials. (To find your login credentials, please refer to part 3 of this guide: **Console Setup > Logging in.**)
4. On your DVR, navigate to the section that says **Display**. This menu allows you to configure resolution and display settings.



5. Then, on the new window, change your resolution from **1280x1024** to **1920x1080**. Once complete, scroll down to the bottom and click on **Save** to save your display settings. Your DVR will reset to effect the change.

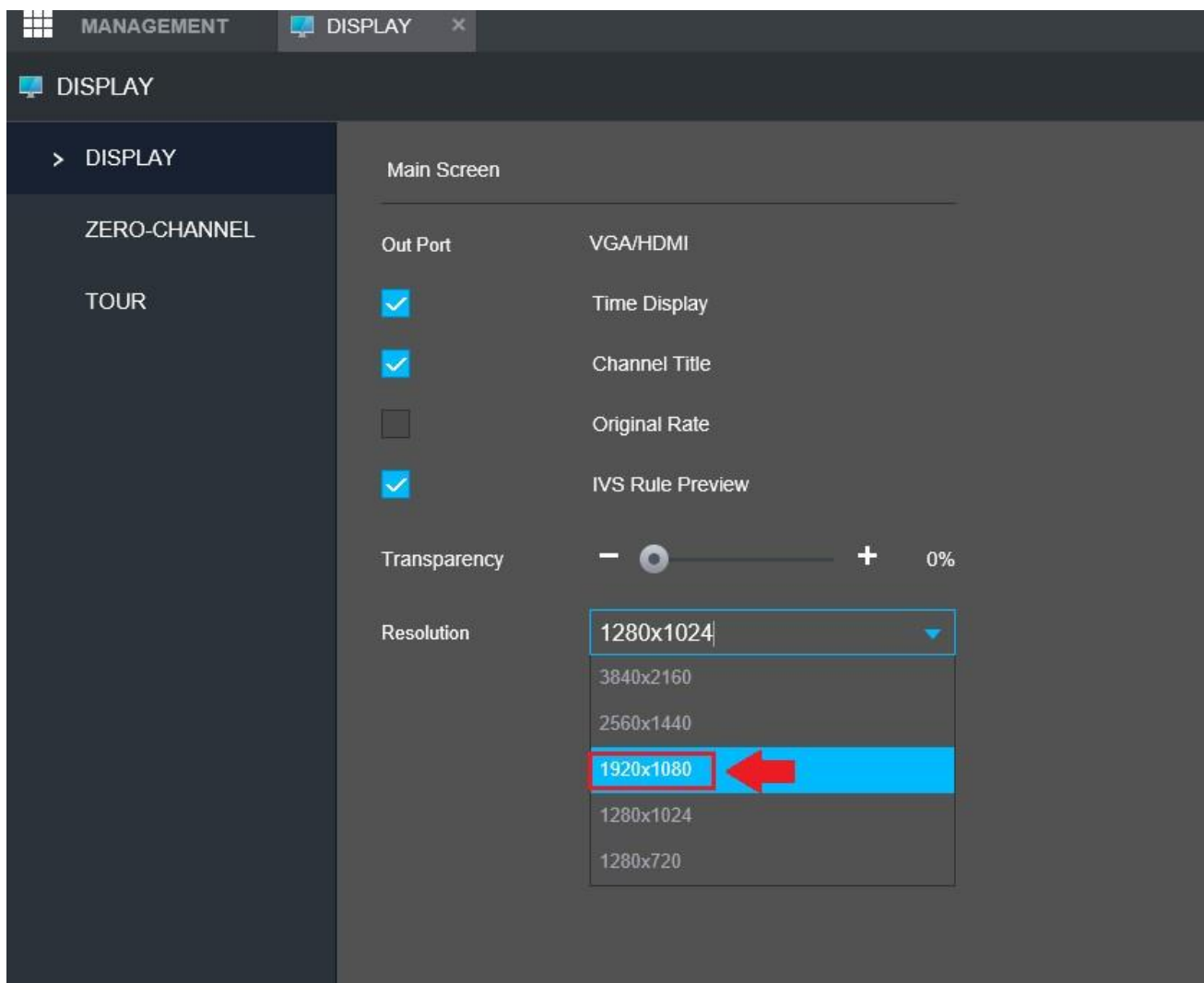

6. Disconnect the VGA cable and connect your DVR to an HD monitor or TV using an HDMI cable. Don't forget to change the input to HDMI on a TV. Your interface will now appear, and you can use your DVR freely.

Hard drive installation

A hard drive allows you to configure and use the recording functionality of this DVR, including playing back previously recorded footage.

Note: This section *only* applies to HDCVI DVRs purchased without a hard drive already preinstalled. Most 'kits' or 'bundles' will come with a pre-installed hard drive.

The DVR has connections for only 1 hard drive inside the case and the hard drive must be no bigger than 4TB (Terabytes).

To install your hard drive, the following is needed:

- A medium sized (regular) Phillips-head screwdriver - *not included*

- A hard drive - *not included (unless you purchased a 'kit' that **does** have one included)*
- Four hard drive fastening screws - *included*

Note: Before installing the hard drive, make sure the DVR is powered off with the power cable disconnect.



1. Loosen the screws of the upper cover and side panel.



2. Attach four screws in the HDD (Turn just three times).



3. Place the HDD in accordance with the four holes in the bottom.



4. Turn the device upside down and then turn the screws in firmly.



5. Attach the HDD firmly.



6. Connect the HDD cable and power cable.



7. Put the cover in accordance with the clip and then place the upper cover back on.



8. Secure the screws in the rear panel and the side panel.

Once the hard drive is installed, boot your system and, for any cameras that are configured to be recording, you will see the following 'recording' icon appear in the bottom-left corner of the live view window for that camera.

4. Console Setup

1. Enter Password

After turning the system on, the default video display shows multiple windows and a page will appear that asks you to change your password:

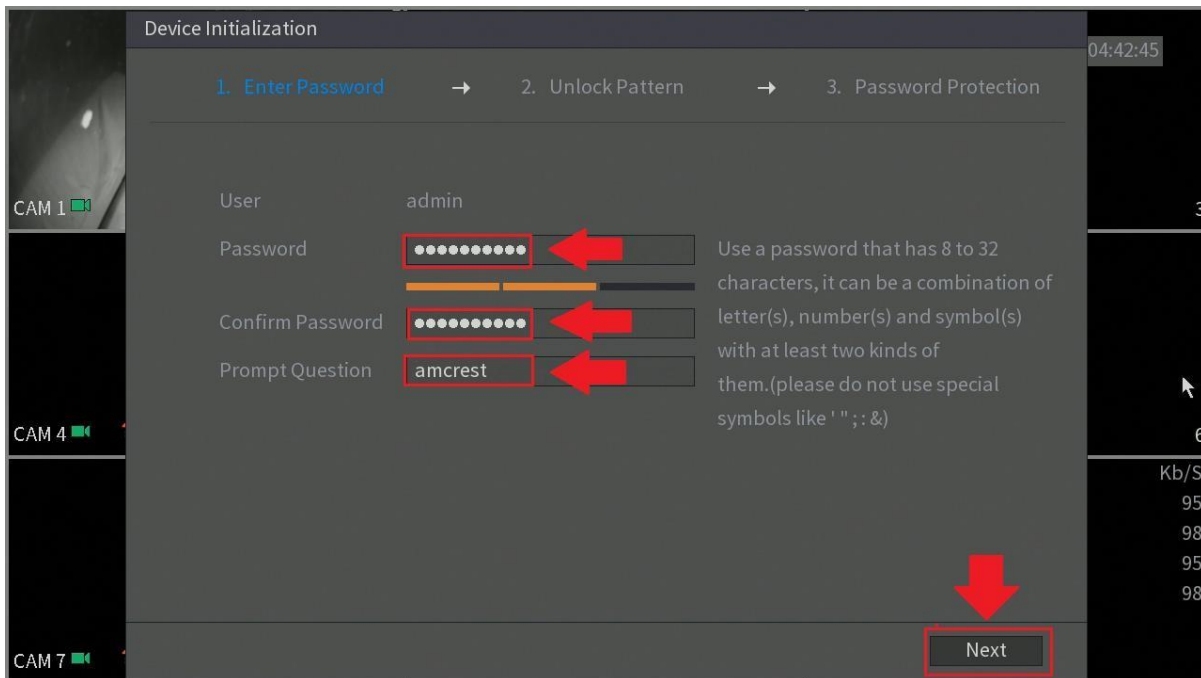

First, create a new admin password for your device. The password for your device should be between 8 and 32 characters. A combination of letters, numbers, and symbols are recommended.

Note: Please do not use special symbols like ' ; : &

Once you've entered a new password for your device, confirm the password in the next field.

Please note that the system consists of two accounts (out of the box):

- **Username:** admin **Password:** admin (administrator, local and network)
- **Username:** default **Password:** default (hidden user)

Lastly, you will be asked to enter a prompt question for your account. This is useful if you have forgotten your password. Please use a prompt question what will help you remember the password for your device.

After you have completed this section, click **Next** to continue.

2. Unlock Pattern

This is an optional security measure for your device. You can also assign an unlock pattern for your admin account. To set an unlock pattern, using your mouse, draw a design which you will remember to access your device. **If you do not wish to assign an unlock pattern, you can click “Skip” to skip this process.**

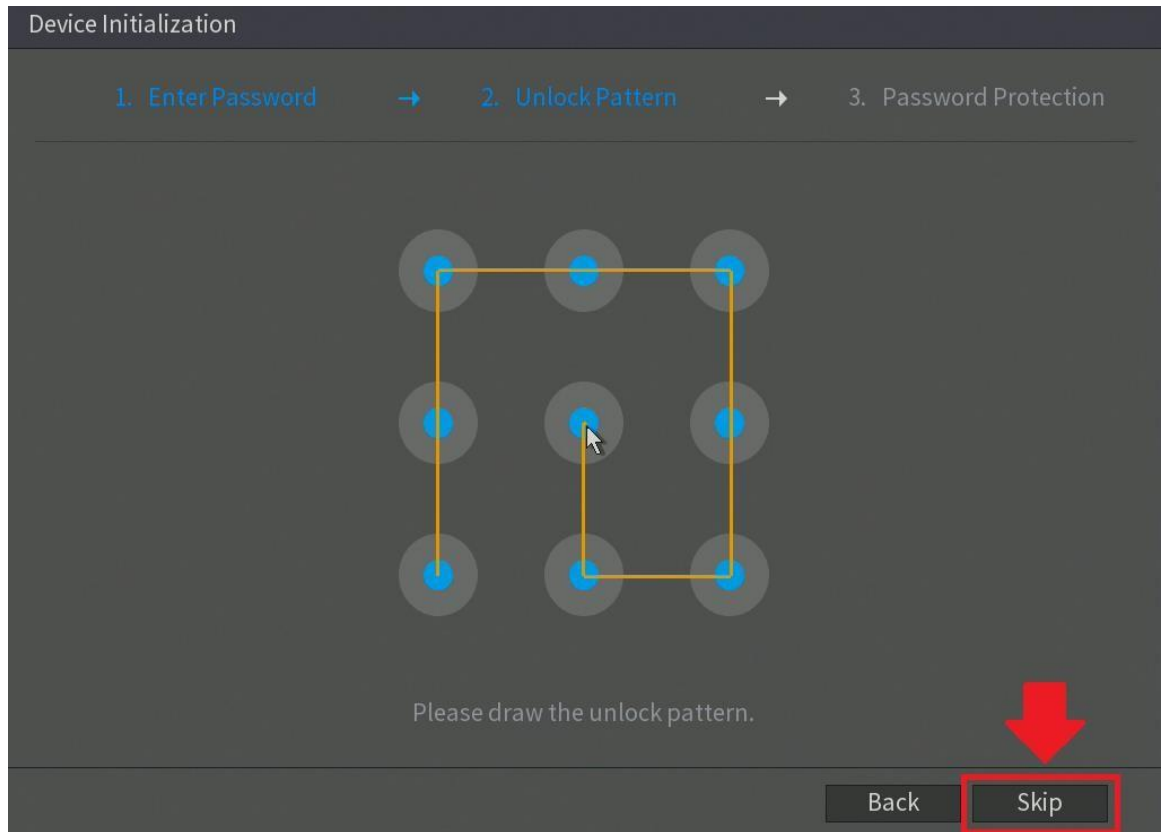

If you have assigned an unlock pattern, you will need to draw the pattern again to confirm the validity of your assigned unlock pattern.

3. Password Protection

Another means of password retrieval can be set up in this menu. If you would like to reset your password via email, toggle the toggle switch to the on position and enter a valid email address in the **Email Address** field. The email address will be retained in the system.

If you do not wish to use an email address, you can enter security questions. To enable security questions, toggle the toggle switch to the on position in the **Security Questions** field. Select a question from the drop-down menus for **Question 1**, **Question 2**, and **Question 3** and enter the answers to those questions in the **Answer** fields.

Device Initialization

1. Enter Password → 2. Unlock Pattern → 3. Password Protection

Email Address amcrest@amcrest.com

Security Questions

Question 1: What is your favorite children's book?
 Answer: cat in the hat

Question 2: When is your father's birthday?
 Answer: june 7 1956

Question 3: What is the name of your favorite fruit?
 Answer: apple

Save

Once this section is complete, click on the **Save** button to save your information to the device.

Startup Wizard walkthrough

The first page of the Startup Wizard will appear:

Startup Wizard

Welcome to use startup wizard. This startup wizard will help you set parameters. Click Next to continue.

Startup

Next Cancel

If you do not want to use the Startup Wizard, or you've already gone through it and don't want it to keep appearing, unmark the checkbox next to **Startup** and click **Cancel**.

Note: Every page from the Startup Wizard that follows can be accessed and modified at any time through the Main Menu.

To login to the system for the first time, click **Next**

General Settings

The next screen that comes up is the **GENERAL** settings screen. Once you are satisfied with the settings on this screen, click the **Next** button at the bottom of the screen.

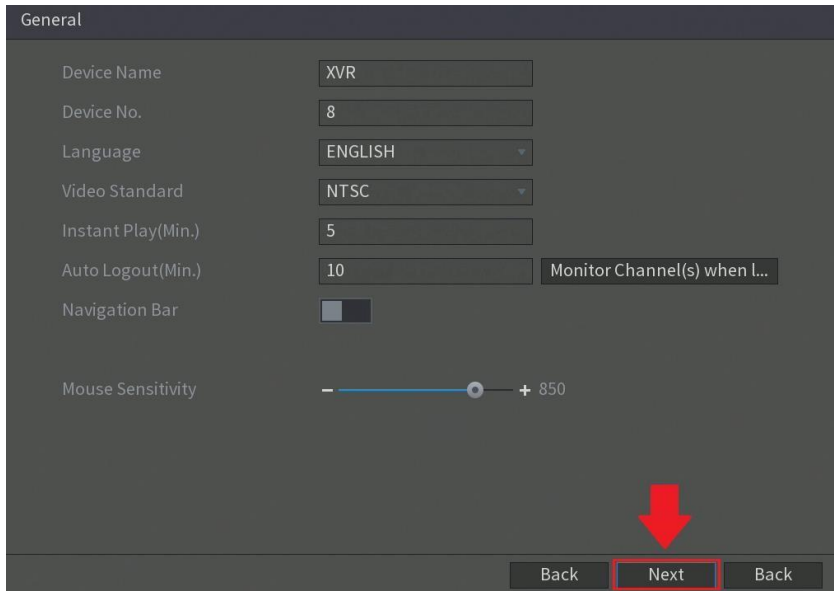

The next screen that appears will be the **Date & Time** settings screen. This is where you can set the date and time for your specific location. If you wish to utilize daylight savings time, toggle the **DST** toggle switch to the on position. Once you have selected the proper date and time for your device, click the **Next** button to continue.

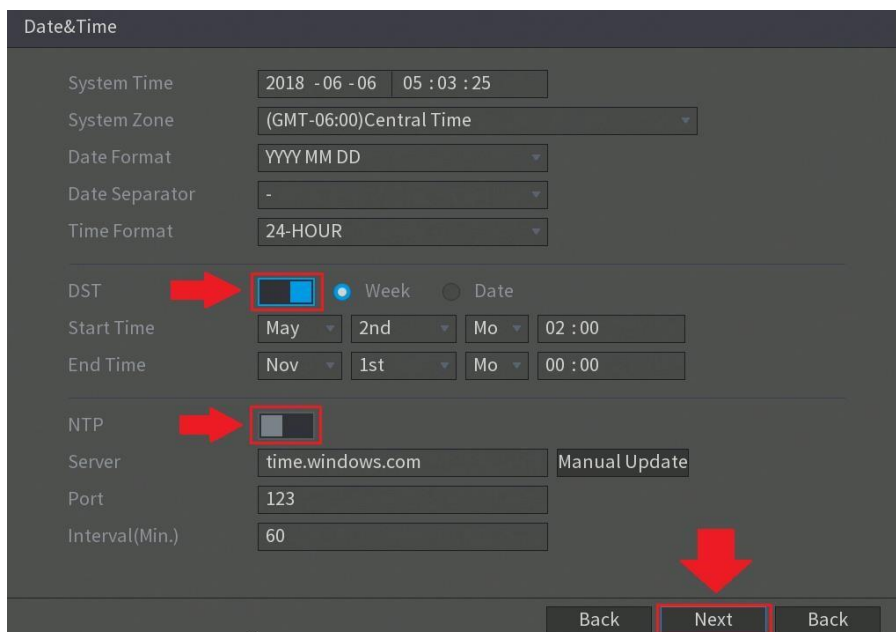

Note: Make sure to toggle the **NTP** toggle switch to the off position to avoid syncing your device to the NTP server.

The next screen that will appear is the **Network** settings screen. In this screen you can configure the network settings. If you want to set your device up to have a static IP, toggle the **DHCP** toggle switch to the off position.

NETWORK

IP Version	IPv4
MAC Address	14:A7:8B:E4:AD:9C
DHCP	<input type="checkbox"/>
IP Address	10 . 0 . 28 . 49
Subnet Mask	255 . 0 . 0 . 0
Default Gateway	10 . 0 . 0 . 1
DNS DHCP	<input type="checkbox"/>
Preferred DNS	8 . 8 . 8 . 8
Alternate DNS	8 . 8 . 4 . 4
MTU	1500

Test Back Next Back

Note: To test the connectivity of the device to your network, click on the **Test** button. The device will return a network status. To return to the previous menu, click the **Back** button.

Test

Sender IP Address	10.0.28.49
Destination IP	10.0.0.1
Test Result	Average Delay:1.168ms Packet Loss Rate:0%
	Network Status:OK

Test Back

The next screen that appears is the **P2P** settings screen. This will be enabled by default. It is highly recommended to keep this enabled if you

want to use you're the Amcrest View Pro mobile app or AmcrestView.com to view your cameras remotely.

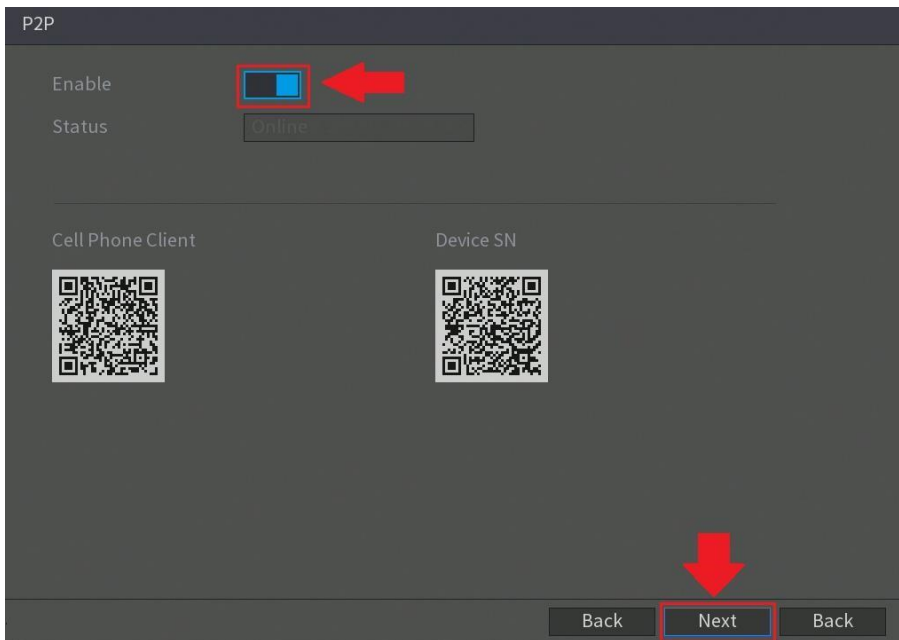

After enabling the P2P toggle switch, click the **Next** button to continue.

The next screen that appears is the **ENCODE** settings screen. This is where you can adjust the video quality settings for your DVR/cameras, including the compression and frame rate. To access or adjust audio formats, click on the **More Setting** tab.

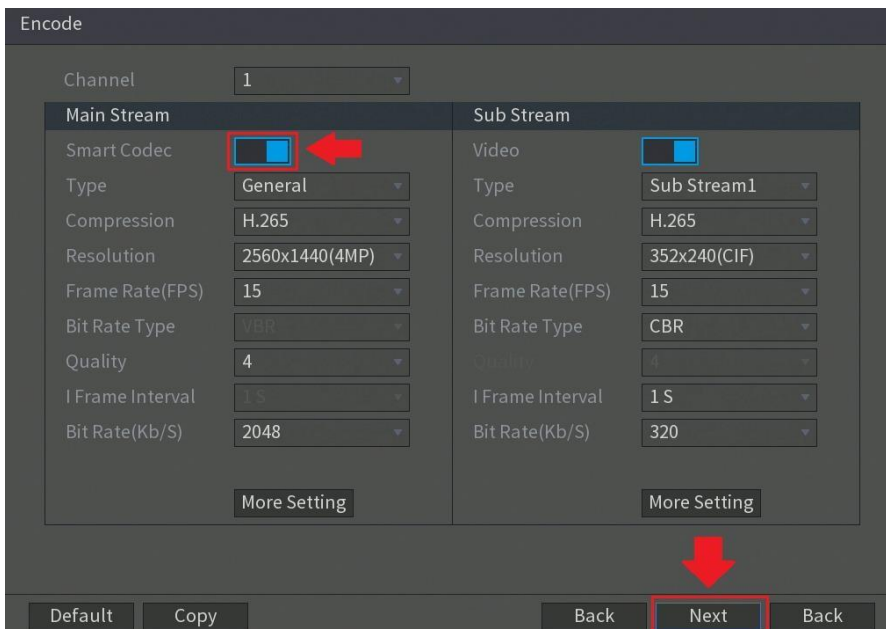

After adjusting the encode settings for your device, click on the **Next** button to continue.

The next screen that will appear will be the **Snapshot** settings screen. This is where you can adjust the settings for your snapshots. This includes, the image size, quality, as well as interval in which the snapshot is retained. Once set, click on the **Next** button to continue.

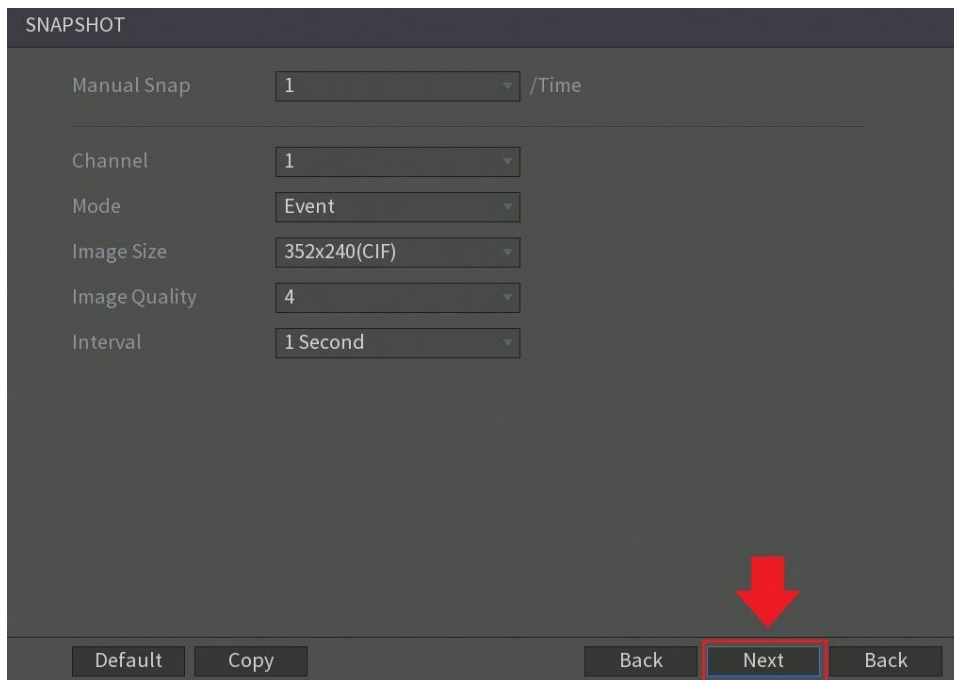

The next screen that will appear will be labeled **Basic**. This is where you can configure your hard drive settings including, when to overwrite a full hard drive or customizing an auto-delete option. The auto-delete option pertains to old files and how long you would like that data to remain on your hard drive. This is measured in days and is set with a built-in number pad.

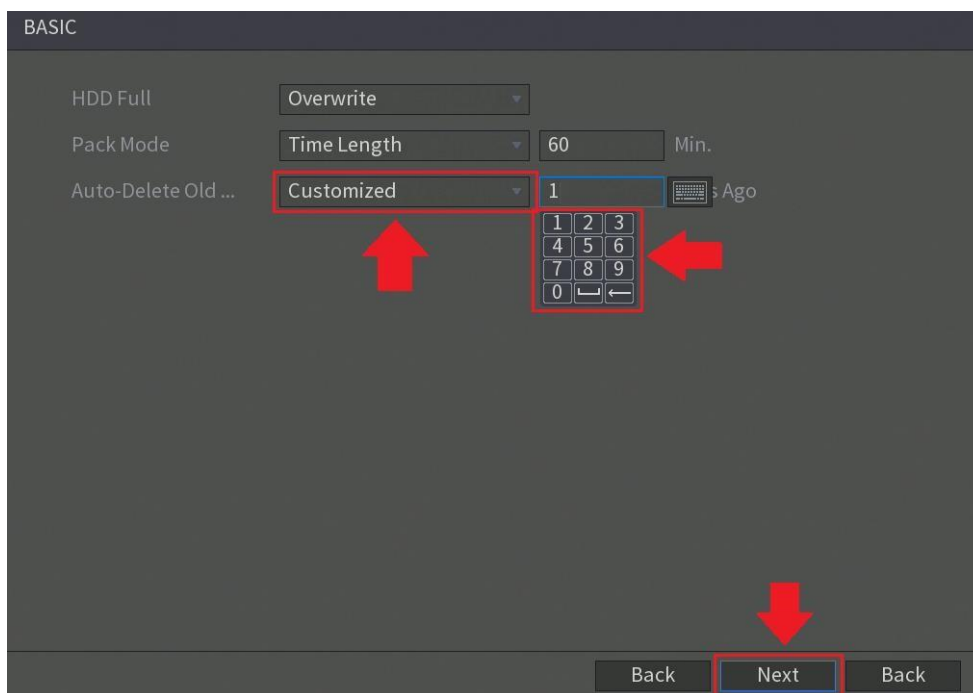

The next screen you see is the **Record** settings screen. Your DVR is configured, by default, to record everything on all channels 24/7 (this will only actually happen provided you have a hard drive installed). You can also use this screen to set up motion detection and alarm schedules.

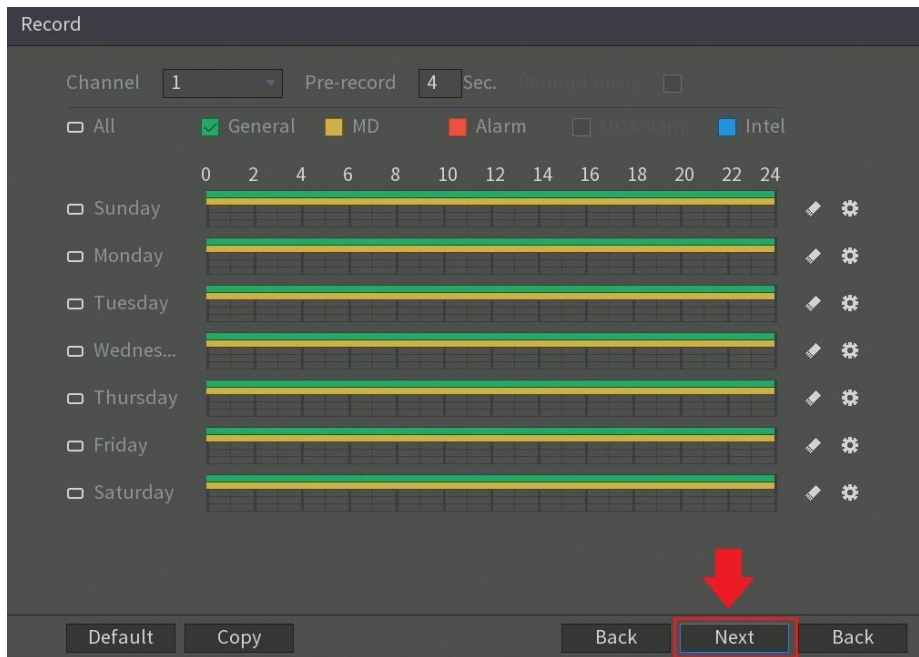

Once you are satisfied with the settings on this screen, click the **Next** button at the bottom of the screen.

Next you will be able to configure your snapshot settings for your scheduled recordings. You can also use this screen to set up motion detection and alarm schedules for snapshot events. Once you have scheduled your events, click on the **Finished** button to continue.

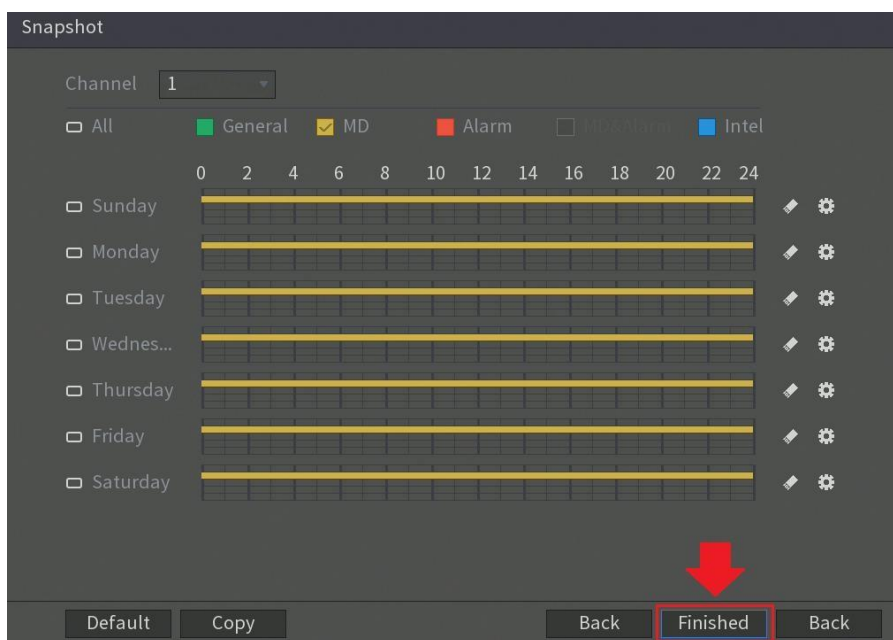

Once the setup process is finished and you have clicked the “Finished” button, you should see the below dialog box:

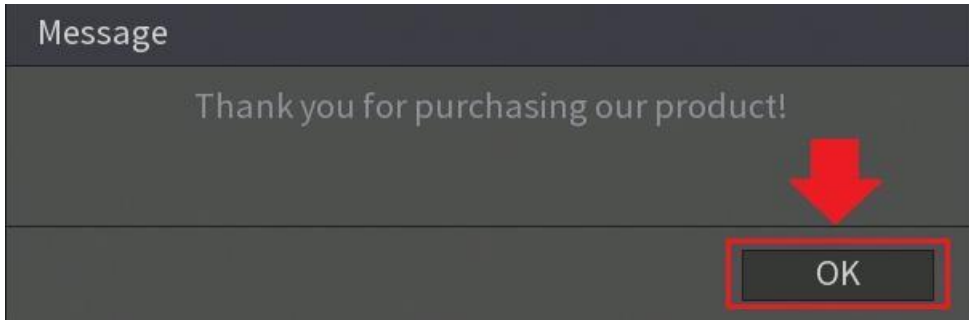

Click OK to continue and the next screen you will reach will be the home video wall screen for your system.

Before following this guide to the next step, that covers the main menu, you will need to left-click once or right-click and select 'Main Menu' from the right-click menu.

Main Menu overview

The screenshot below is the main menu screen for the Amcrest DVR console interface:

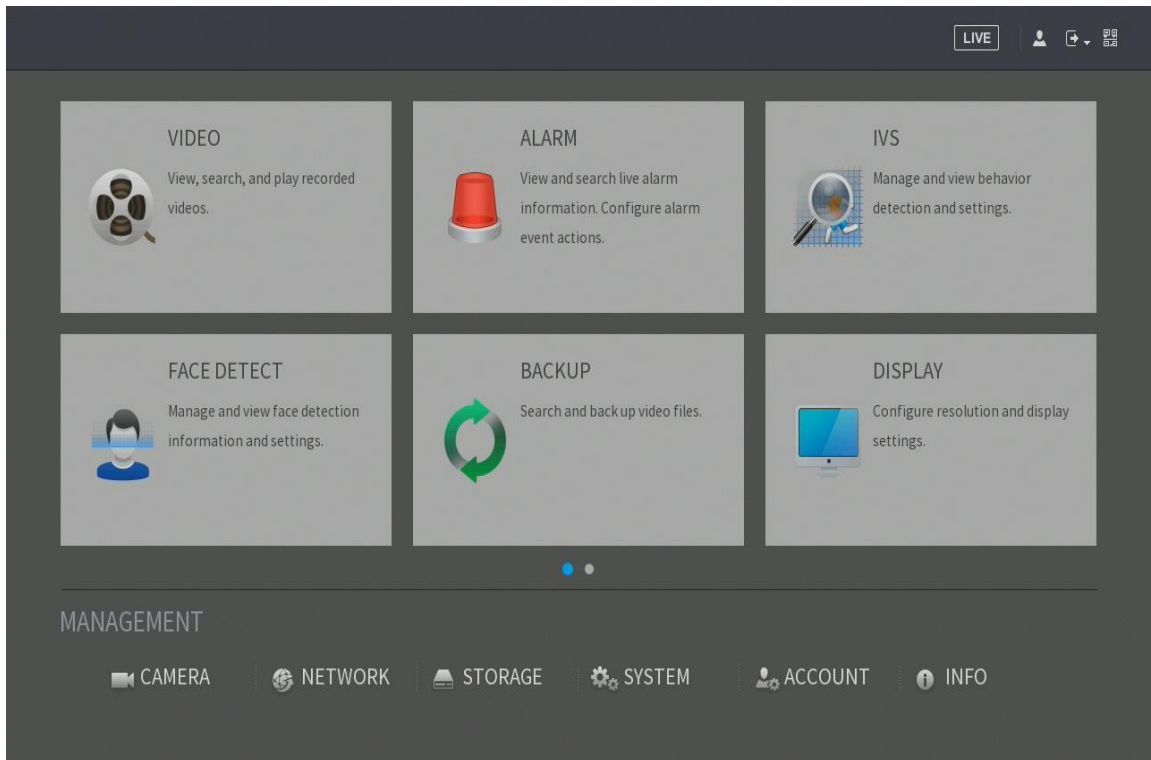

Below are short descriptions for each of the menu items on the main menu:

VIDEO: Search and playback recorded video that is stored on the hard drive. **ALARM:** View and configure live alarm information and notifications sent by the device.

IVS: Manage and set IVS and intelligent detection settings (if applicable).

FACE DETECT: Manage and view face detection information and settings (if applicable).

BACKUP: Search and backup video data via a external USB or flash drive. **DISPLAY:** Configure resolution and display output settings.

Management

CAMERA: Review or edit settings for each camera, including video settings (e.g. quality, bit rate, color, etc.).

NETWORK: Review or edit network settings for the DVR (e.g. email, DDNS, UPnP, etc.) **STORAGE:** Review or edit storage parameters and settings. (e.g. motion detection, alarm, etc.). Set HDD detection as well as setup FTP settings.

SYSTEM: Review or edit system parameters or configuration, including system maintenance, factory resets and firmware upgrades.

ACCOUNT: Review admin accounts and add new users to device. (e.g. ONVIF users).

INFO: Review system, log, network, HDD and channel information (e.g. Bps and connectivity)

5. Motion Detection & Recording Setup

This section will cover how to set up your DVR's **scheduled recordings** for both **regular** and **motion detection** recordings. It will also cover how to set up **email alerts with snapshots**.

Note: The DVR can only be set up to save regular and motion detection recordings if a hard drive has already been installed. However, email alerts with snapshots can still work without a hard drive installed.

A hard drive is included with every DVR 'kit' purchased. You can confirm this by looking at the packaging. If bought as a *standalone* DVR, a hard drive will need to be purchased separately. Once purchased separately, for hard drive installation instructions, please refer to part 3 of this guide.

The following setup processes will be shown using the DVR console's built-in interface. However, these same steps can also be done through the web interface on a computer. Despite the difference in appearance, the settings pages have the exact same organizational structure.

Setting up recording schedules

1. Log into your DVR with your username and password:

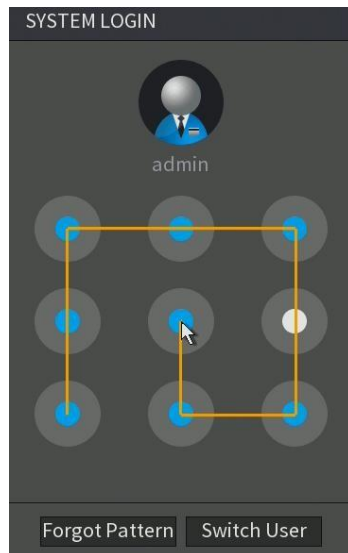

2. Open the **MAIN MENU**, then click **STORAGE** in the **MANAGEMENT** row:

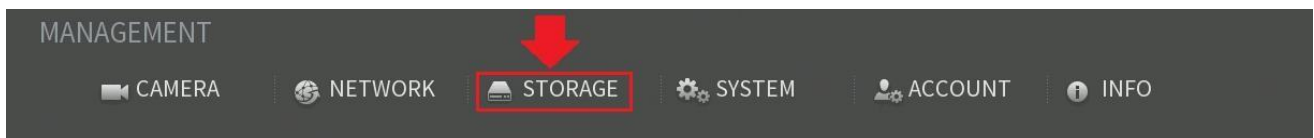

3. Make sure you are on the **SCHEDULE > Record** page. This is where you can configure the times and days you would like different kinds of recordings to happen.

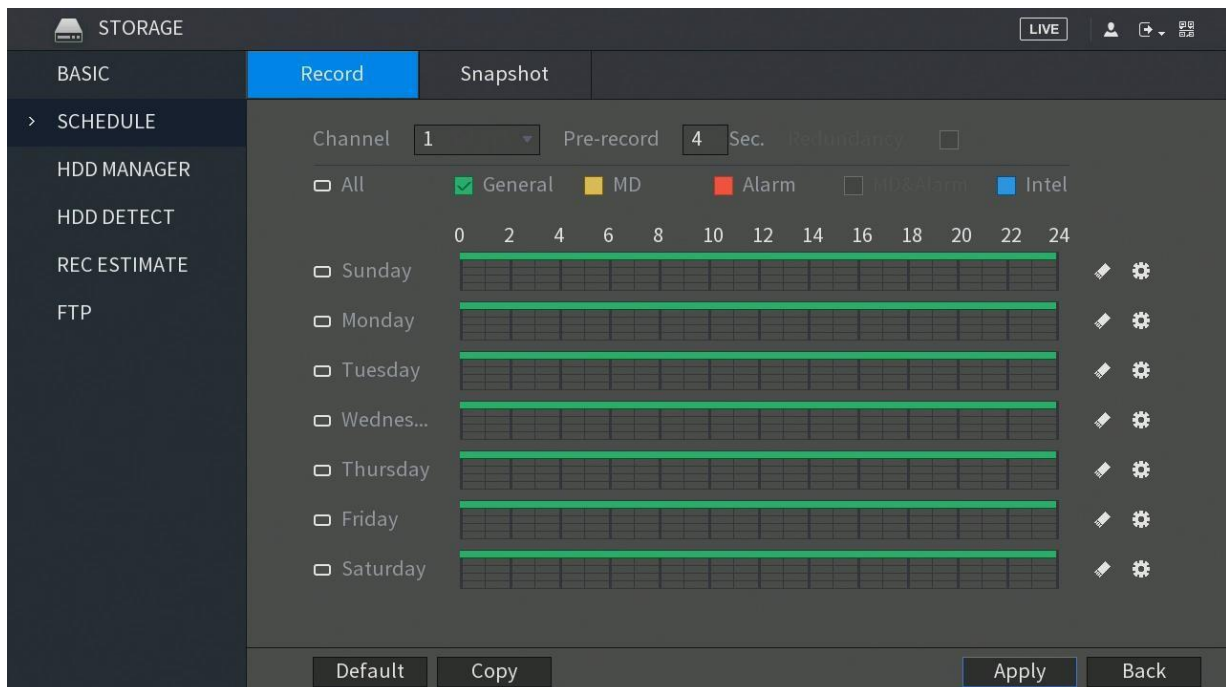

4. To choose a channel (or camera) for which to configure the recording schedules, click the number next to **Channel**, then select either a single channel or **All**:

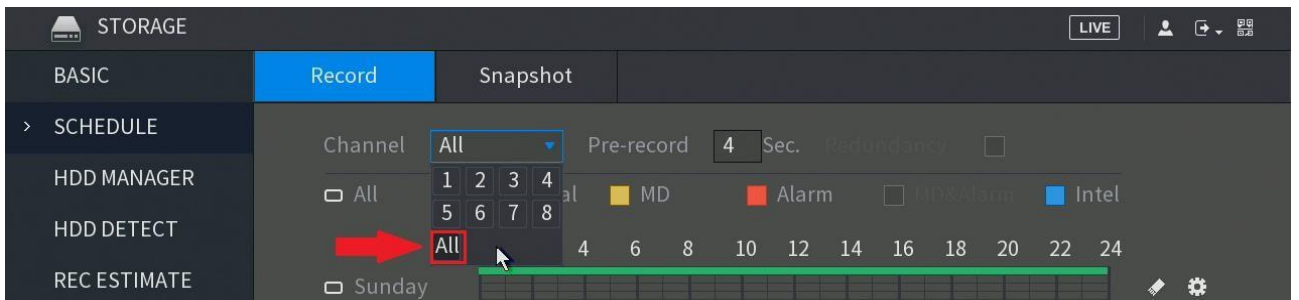

5. By default, the DVR will have the schedule configured to record regularly 24/7. Notice the green bars going across each day of the week. Also note that the DVR uses military time, that is, from 0 to 24 instead of from 12 a.m. to 12 a.m.

To change which hours, you would like the DVR to record, make sure the **GENERAL** checkbox is checked, then click the blocks in the grid. You can also click and drag to add or remove multiple block at a time. Each block represents one hour:

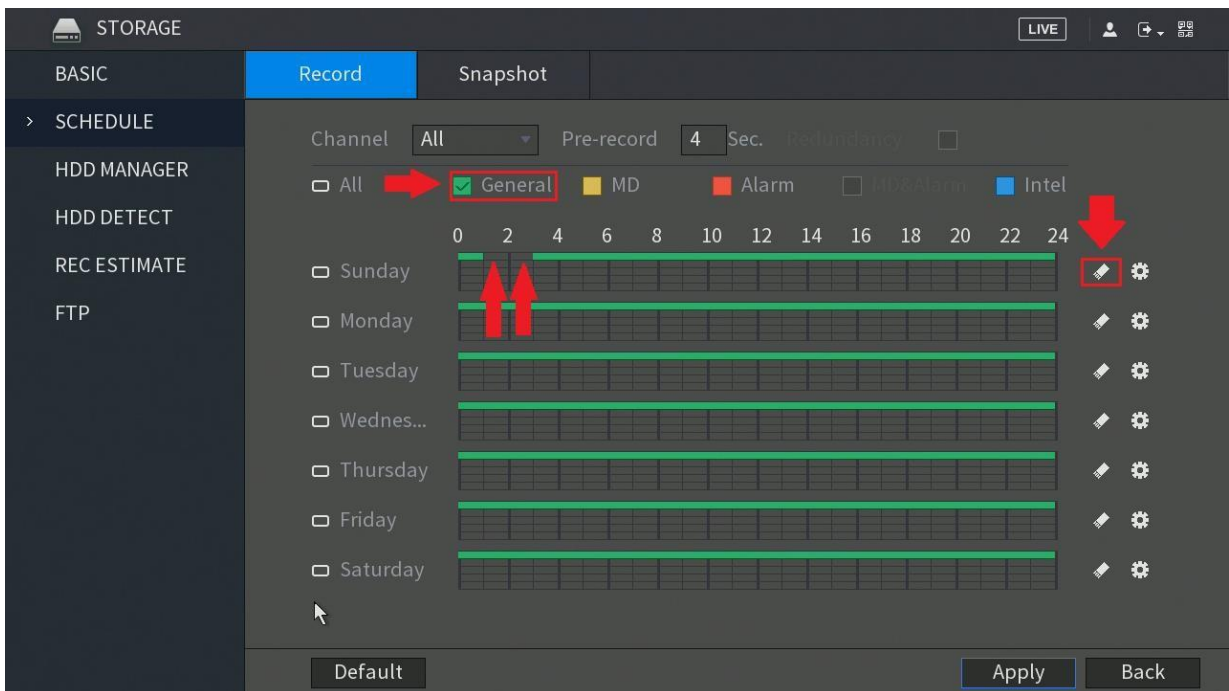

Click the eraser icon to the right of any day to clear the entire row of all green blocks.

6. To add or remove motion detection blocks to the grid, mark the checkbox next to **MD**, then click individual cells or click-and-drag for multiple blocks:

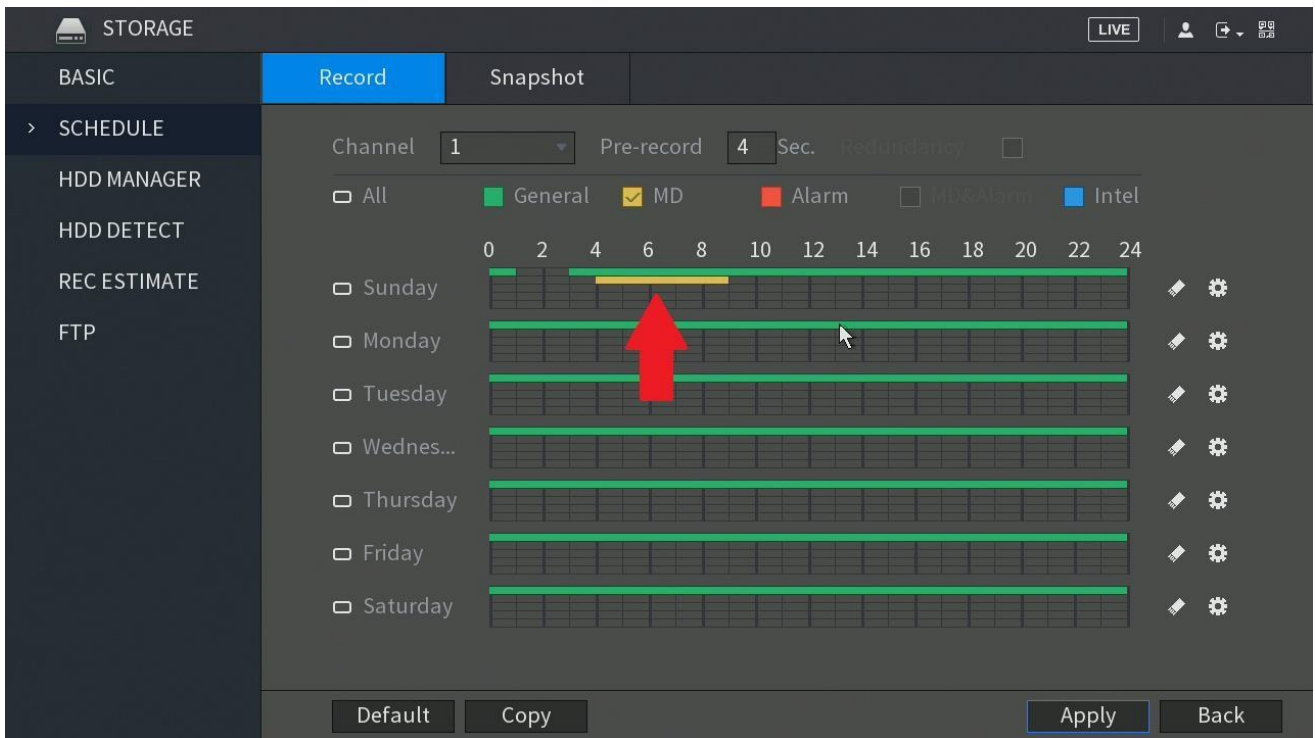

7. To the left of each day, there are small boxes which can be marked to “link” different days together. This is useful if you want to save time by instantly making changes to multiple days simultaneously.

In the below example, Sunday and Monday are linked, so any blocks that are added or removed for Sunday will automatically and immediately reflect the same for Monday and vice versa:

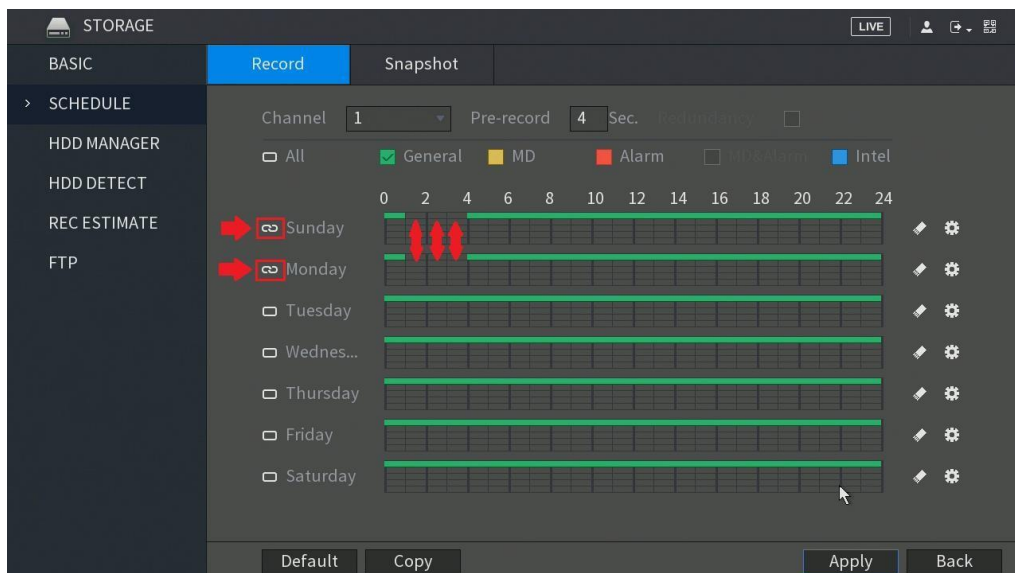

8. Another way to configure recording schedules is by using setting the time periods. Click the ‘gear’ icon to the far right of any day to open the **Period** page:

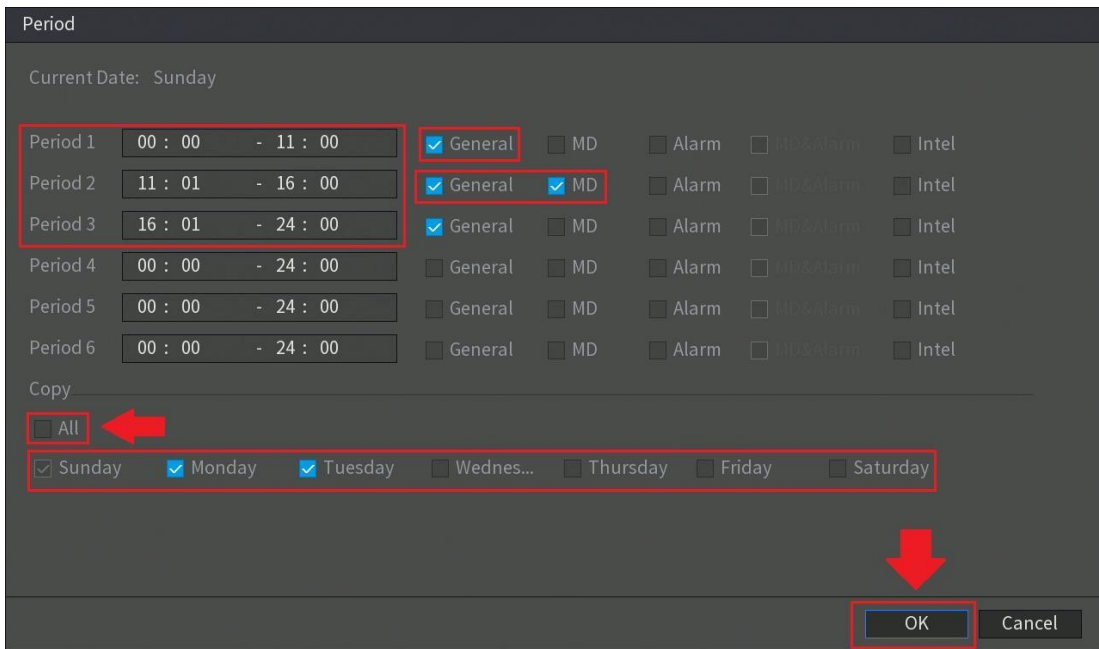

Here, the periods (Periods 1 - 6) must be in specified in chronological order. You can set either **General**, **MD**, or both with the checkboxes to the right. You can also copy the period settings over to other days by checking them individually or checking **All**. Make sure to click **OK** when finished.

9. Now that you've finished configuring the recording schedules, you may need to copy these settings over to another channel (or camera). By default, Channel 1 will be selected when you visit this page. Unless you immediately selected **All** in the channel window from step 4 above, note that you can copy these settings directly over to another channel by clicking **Copy** down below:

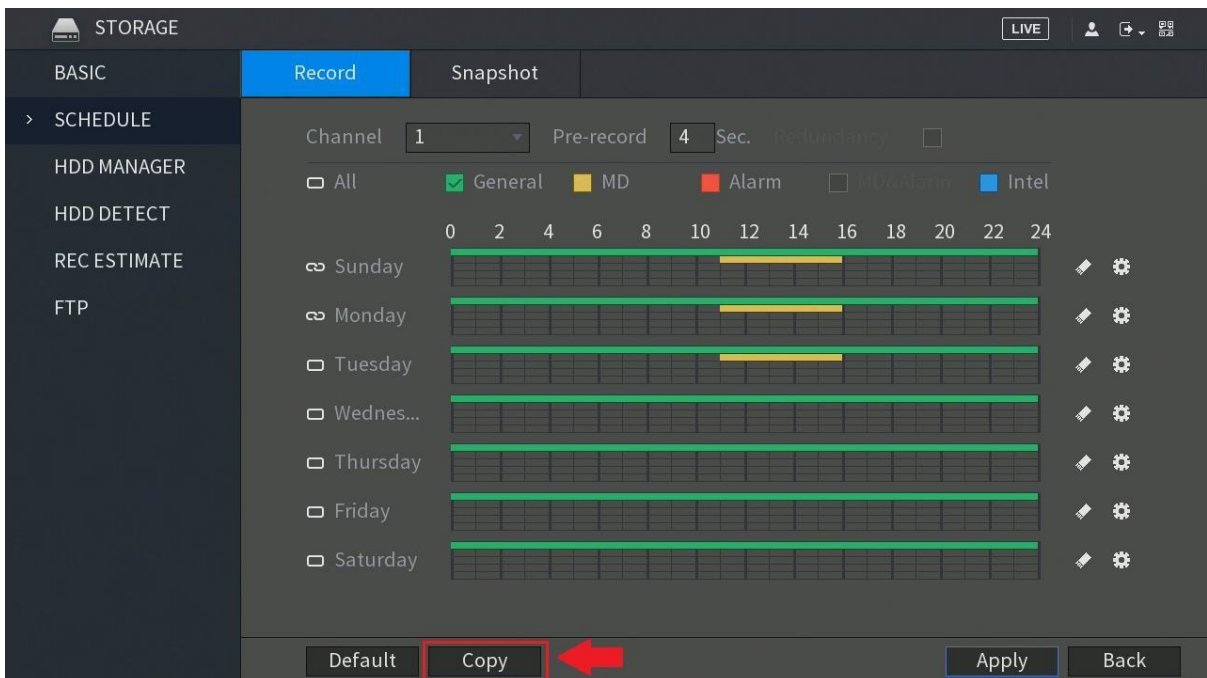

In the **Copy** window, you can select individual channels for any cameras you have added to the DVR or select **All**:

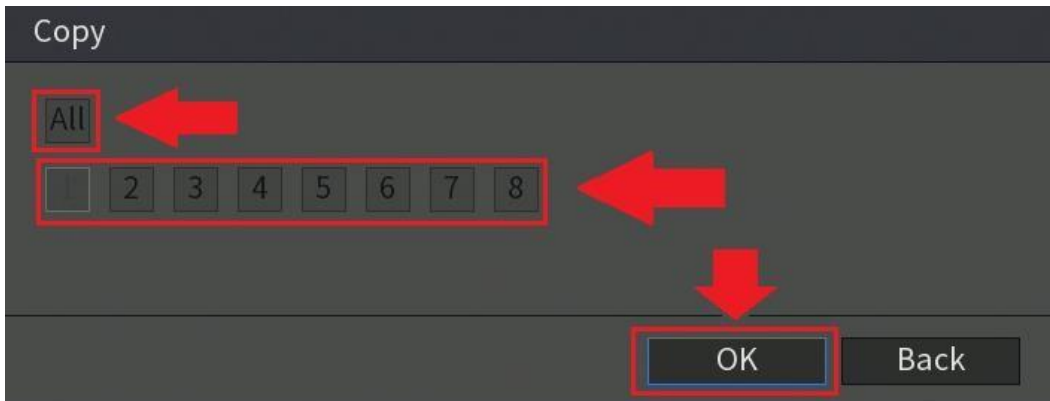

Click **OK** when finished.

10. When finished on this screen, click **Apply** to save your changes.

Setting up motion detection and email alerts

Your DVR will save motion detection recordings, in addition to scheduled 'regular' recordings and distinguish between the two in the playback menu.

1. Log into your DVR with your username and password:

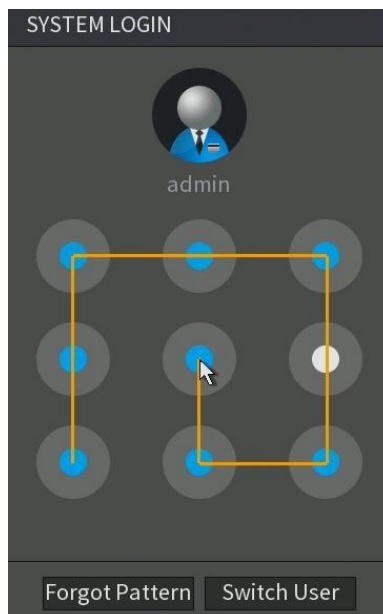

2. Open the **MAIN MENU**, and click the **ALARM** tab.

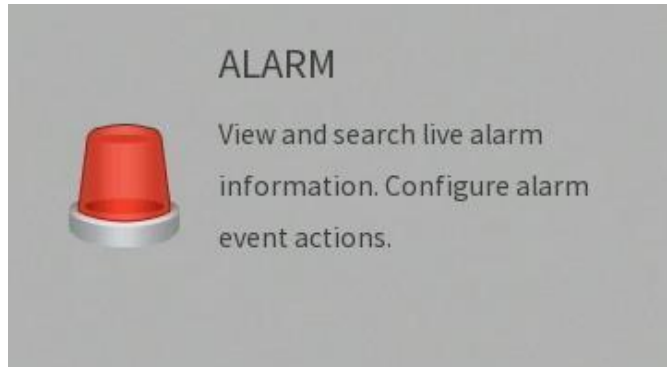

2. In the alarm menu, click on **VIDEO DETECT**. This is the main configuration page for motion detection:

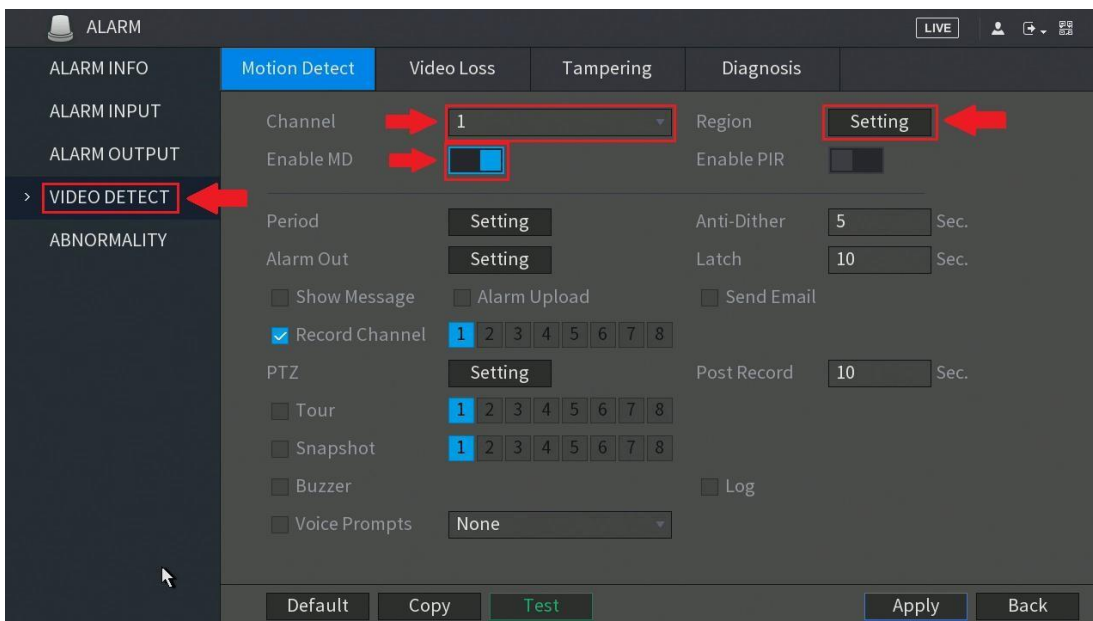

Change your channel (or camera) by clicking **Channel** and selecting from any cameras currently added to the DVR. You can also select **All**. Make sure the **Enable** toggle switch is activated. Then, click **Setting to Region** to configure the motion detection areas.

3. You can set up 'regions' for motion detection using the region grid on your DVR.

By default, the entire area of view for your cameras will be highlighted with red blocks. This means that the entire field of view is *active* for motion detection:

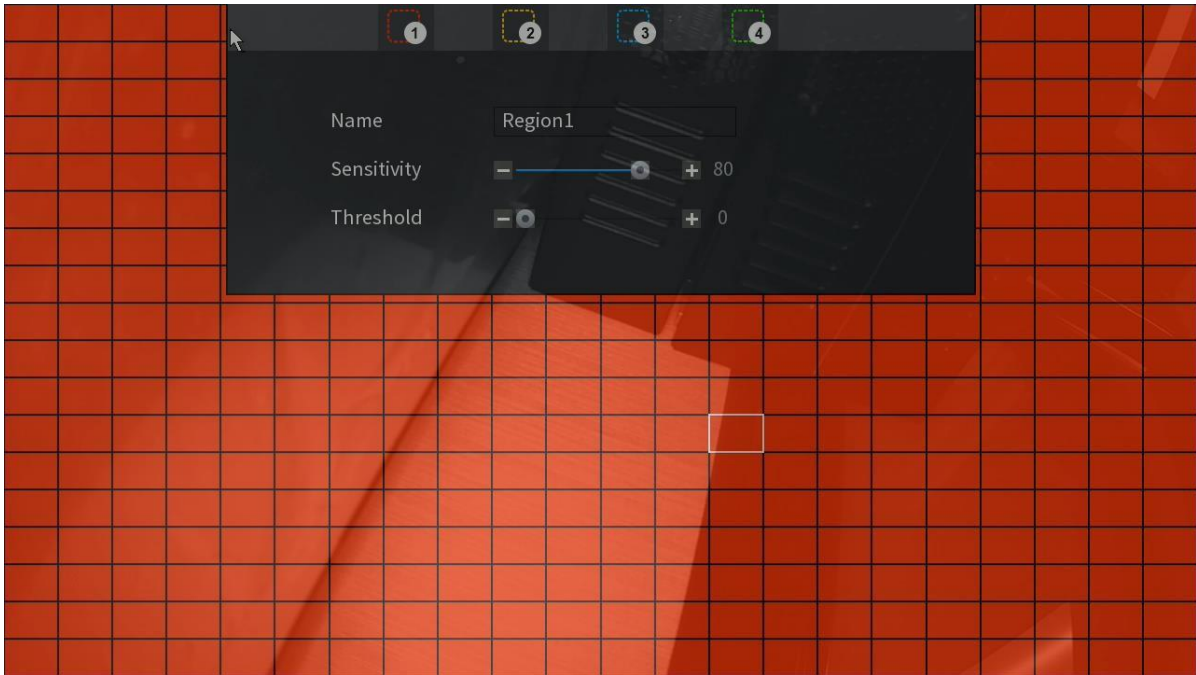

Any red blocks that you click or click-and-drag to *remove* will *not* be active for motion detection. Motion detection will not work for any portion of the screen that is *clear*.

If you hover your mouse pointer over the top-center edge of this window, another small window will appear with options to configure **sensitivity** and **threshold** settings as well as to choose from up to **four regions**.



Sensitivity - is the measure of how many pixels on the screen need to change before being considered motion. **0** is the lowest value and **100** is the highest.

In plain English: Sensitivity is the difference between a squirrel running up a tree, versus a big dog running up to and barking at that tree. A squirrel would trigger motion detection at a *higher* sensitivity because it takes *less change or movement to qualify as motion*. But the dog would trigger motion detection at a *lower* sensitivity because it takes *more change or movement to qualify as motion*.

Threshold - is the degree of movement that needs to occur before the motion is defined as a motion event and is triggered. **0** is the lowest value and **100** is the highest.

In plain English: Threshold is the difference between a car driving quickly by on a street and a car driving into the field of view, slowing down, and turning into a driveway. The car driving past *would not* trigger motion detection based on a certain threshold setting, but the parking car *would* trigger motion detection with that *same* threshold setting. The *higher* the threshold, the *more time* motion needs to occur before motion detection is triggered. The *lower* the threshold, the *less time* motion needs to occur before motion detection is triggered.

If sensitivity is set to 100 and threshold to 0, motion detection will be triggered *most easily* by almost any change in the field of view, large or small. But if sensitivity is set to 0 and threshold to 100, motion detection will be extremely difficult to trigger.

The **four regions** are all different colors so you can customize the field of view of any camera to your highly specific preferences.

5. To choose another region, hover your mouse pointer near the top-center of the region window, and a small window will appear. Keep your mouse pointer inside that small window and select either region 2, 3, or 4:

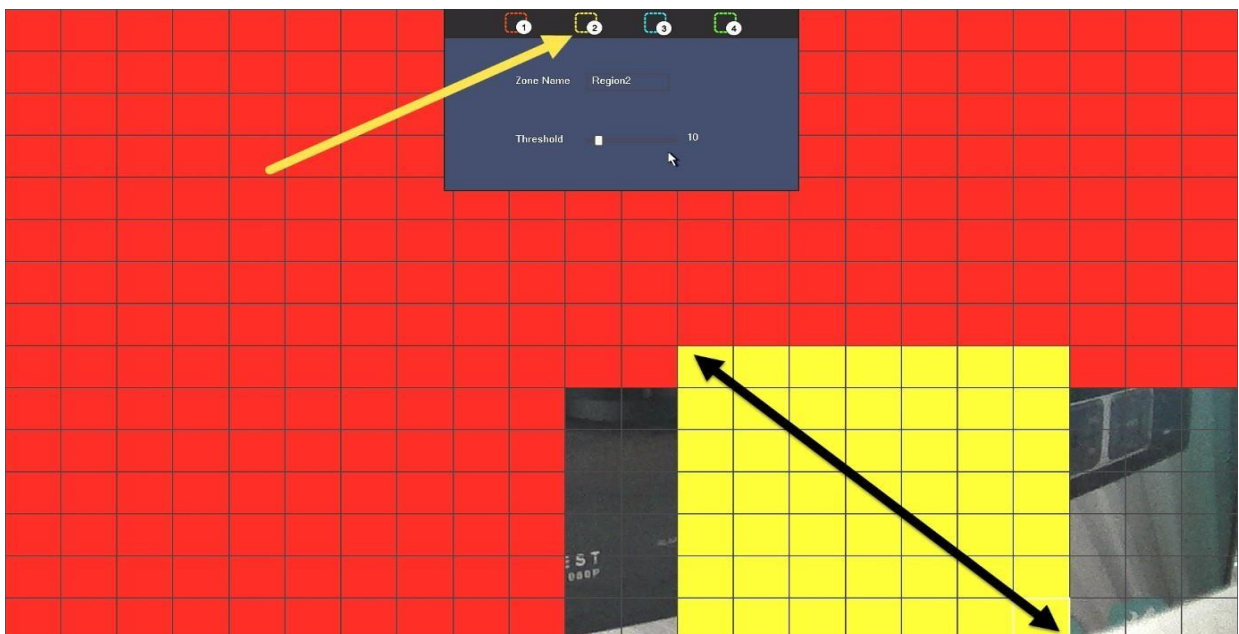

You will be able to click individual blocks or click-and-drag an area with the new selected color to highlight portions of the screen. Each new region (or color) has its own unique

sensitivity and threshold settings. The different regions/colors can also overlap one another.

6. You can also adjust the motion detection schedules directly from this settings page by clicking **Setting** next to **Period**:

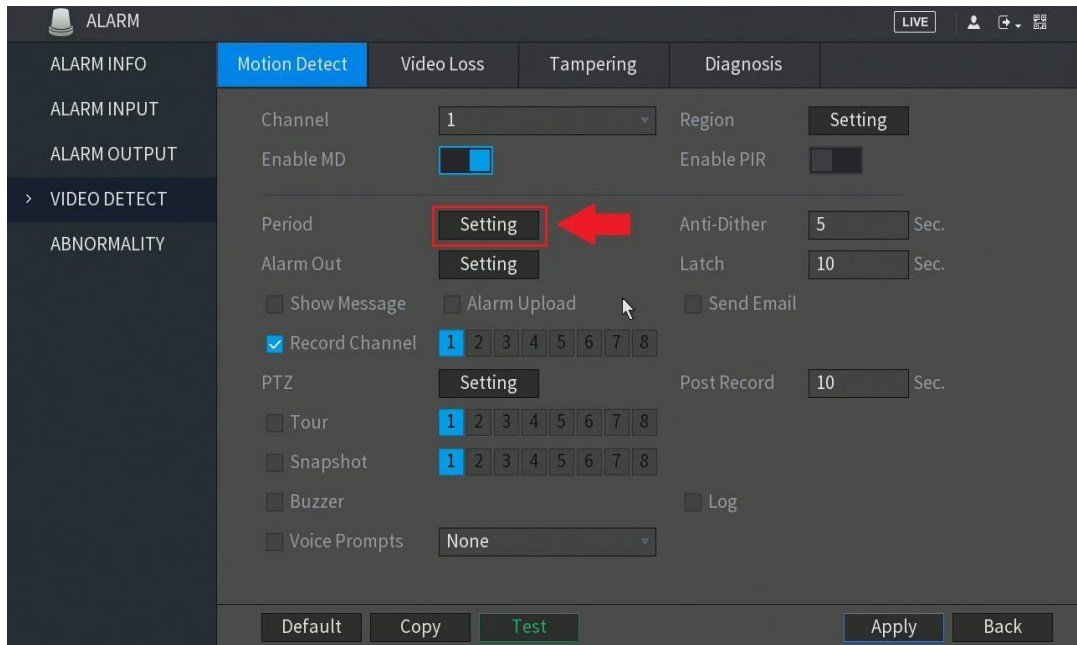

The **Period Settings** page works very similarly to the recording schedule page featured in the previous section in part 5 of this guide.

7. Next, if you want to receive **email alerts with snapshots** from your motion detection events, check the boxes for **Send Email** and **Snapshot**:

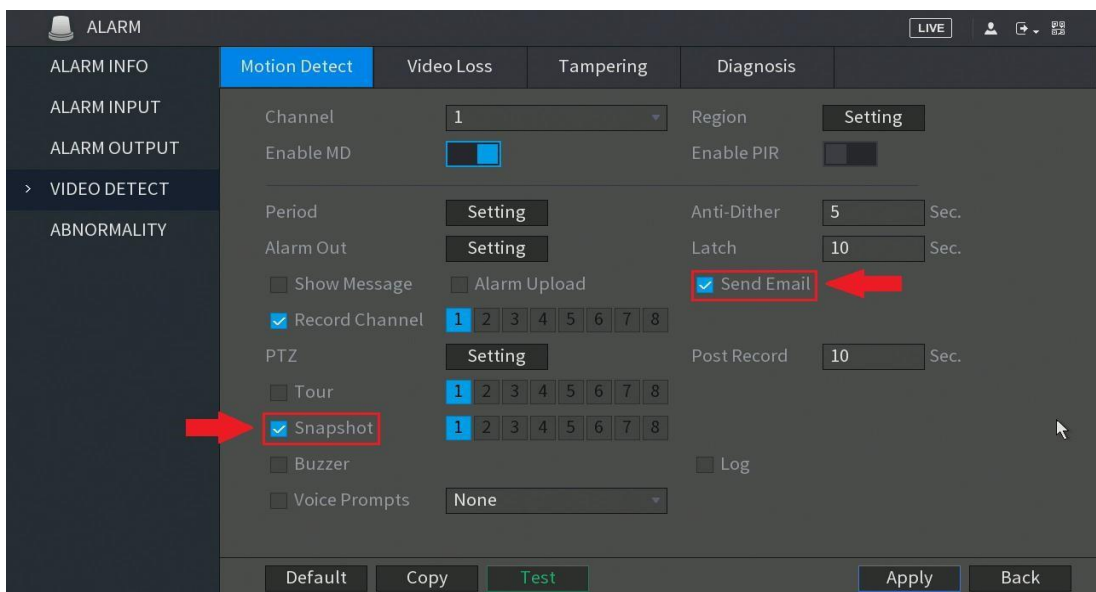

8. Once you have set up your settings for one channel, you can copy them to another channel. If you did not select **All** after clicking **Channel** as described in step 3, click **Copy**, select channels to copy to, then click **OK**:

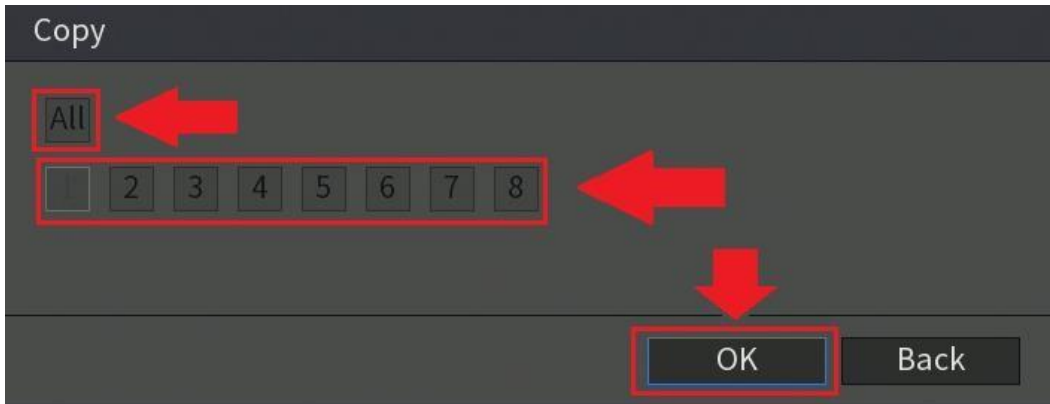

9. Click **Apply** to save all the settings made on this page.

10. Next, go back to the main menu and click the **NETWORK** tab on the bottom row. In the Network menu, click on **EMAIL** from the left navigation panel:

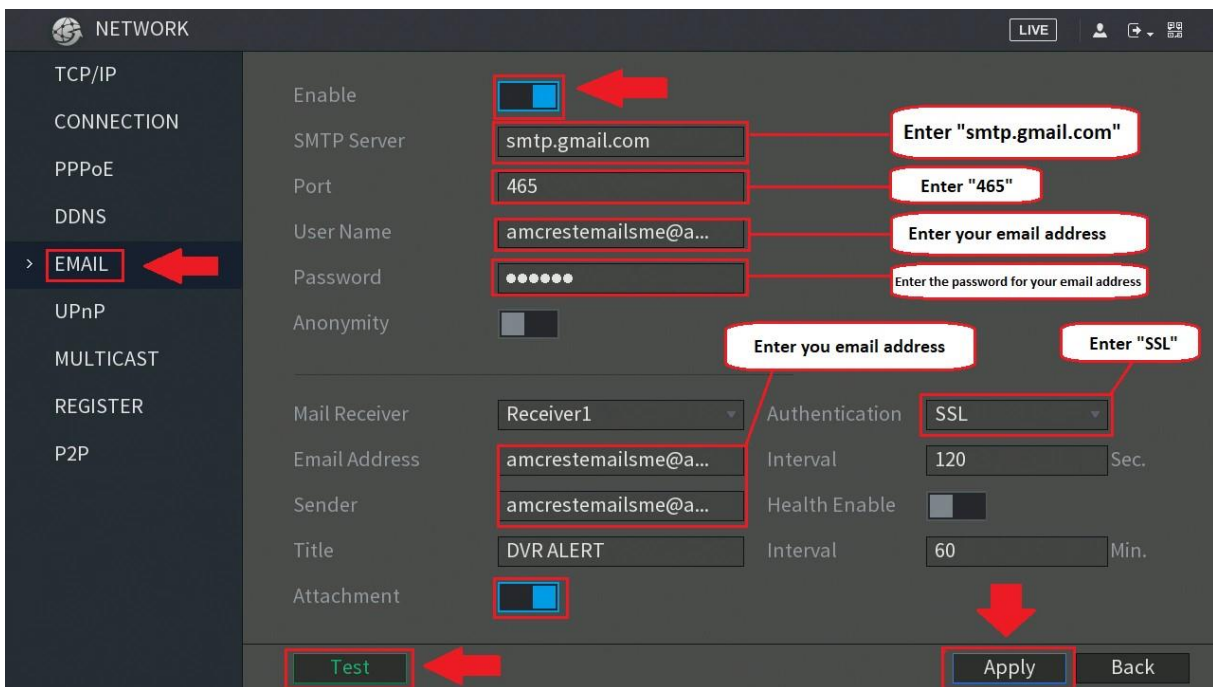

The recommended method for this step is to create a new Gmail account that is dedicated to sending you email alert snapshots for motion detection. This is useful because, then, you don't have to change any of your own personal email's settings. Using a Gmail account is also the easiest way to set up email alerts which could otherwise be somewhat technical and difficult.

This does not mean that you now must log into a second, separate email account just to see your email alerts - because



this email will forward all your email alerts to your personal email. Regardless, it is still recommended to save your email and password information for this new Gmail account.

Start by making sure the **Enable** toggle switch is toggled to the on position. Then, enter the **SMTP Server** which, for Gmail, is: "smtp.gmail.com". The port number will be: "465".

In the **Username** field, enter your new Gmail account's address. For example: "amcrestemailsme@gmail.com". Then, enter the password for this account in the **Password** field.

In the **Email Address** field, enter your own personal email account's address. For example: "amcrestemailsme@gmail.com". In the **Sender** field, enter your email address again.

Make sure the toggle switch for the **Attachment** is toggled to the on position. Then, make sure the **Authentication** field is set to "SSL".

Finally, click **Apply** in the bottom-right of this window to save all your settings.

13. Now, we want to make sure the email setup is working properly. To do this, click **Test** in the bottom-left. If the setup was successful, you will get the "**Mail Test Normal**" pop-up message after clicking **Test**.

14. Next, check your new Gmail account to see if you received the email test:

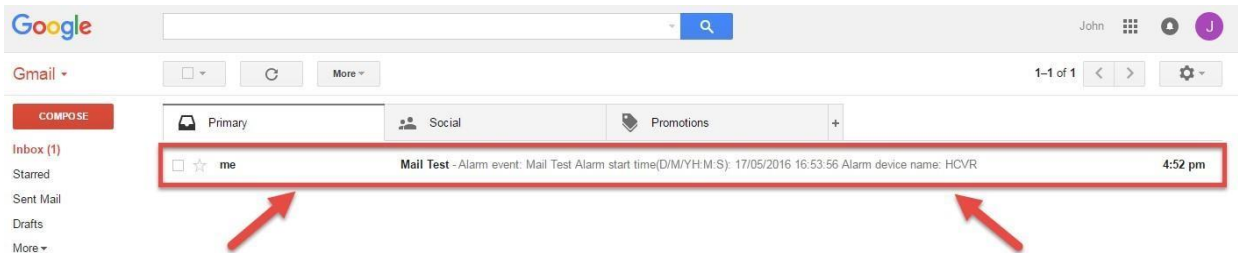

15. Now, whenever your camera detects motion, you will get email alerts sent to your personal email from this new Gmail account:

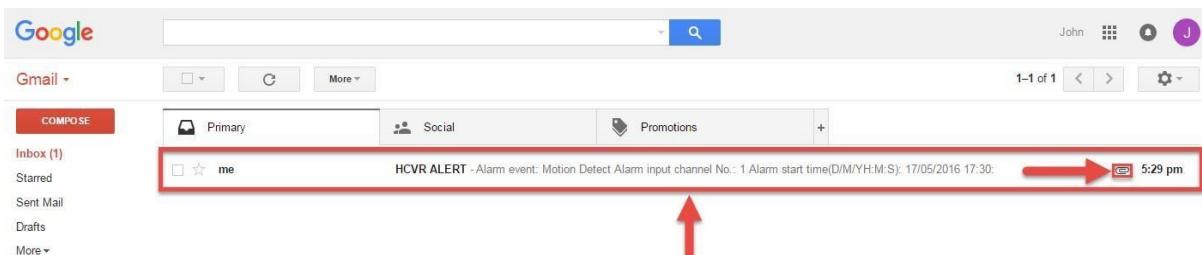

This will include an email with a snapshot of what was seen when motion detection was triggered:



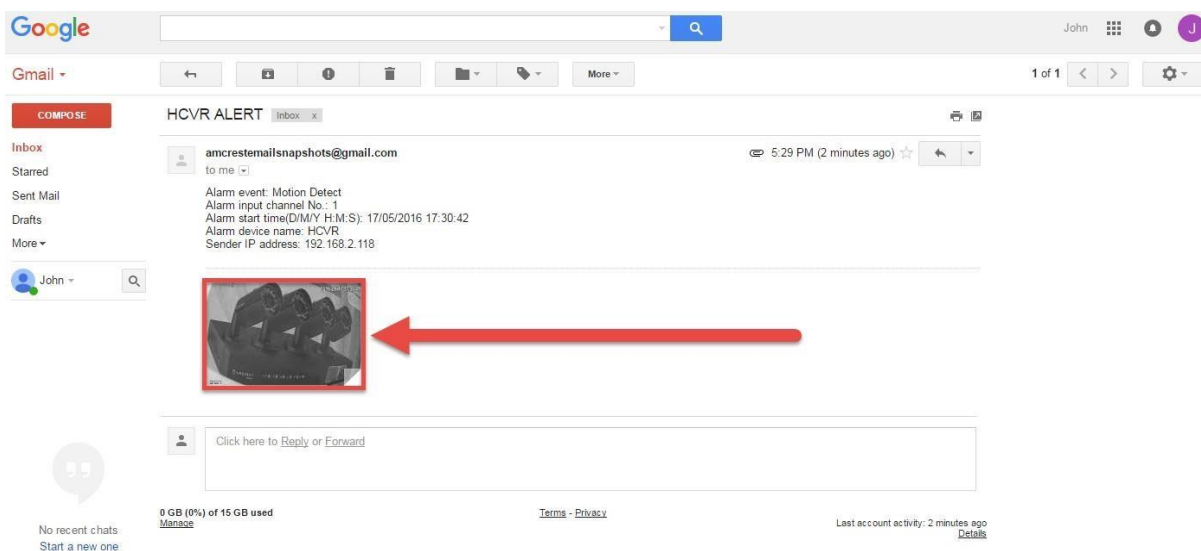

6. Computer Access Setup

There are 2 ways to access your DVR from a computer (laptop or desktop) which are: locally or remotely.

Local Access: Logging into your DVR's web interface from a computer or laptop device connected to the same network as your DVR (home, office, etc.).

Remote Access: Logging into your DVR's web interface from a computer or laptop device connected to a network outside of your home or business network (coffee shop, work computer, etc.).

Local access is preferred by those who, for security reasons or personal preference, do not wish to make their DVR accessible from outside their network. *However, there are several options available for remote access that use standardized and secure network protocols including SSL, TLS, DDNS, etc.* Most other users require remote network access by way of their smartphones, tablets, laptops, or computers, wherever they are.

The following section will cover both means of access (local and remote). Keep in mind that any user can have *both* local *and* remote access simultaneously if they so choose.

Before accessing your DVR through a web browser, the following two steps must be completed:

1. *You must access the DVR's web interface with its **IP address**.*
2. *You must install the Amcrest web **browser plugin**.*

An **IP address** is just an identifier given to any devices that connect to a network. People use names, but internet-connected devices use a set of numbers called an IP address to talk to each other. Once you have the IP address, your computer will be able to find and communicate with your DVR.

A **browser plugin** is just like a translator. Using your DVR by itself, without a computer (the builtin interface featured in previous parts of this guide) is different than using it on your computer. By using the DVR on your computer through a web browser, you need to introduce a new piece of software that allows your computer to understand the language that the DVR speaks in a way that a computer can understand. That's what the browser plugin is for.

There are 2 ways to access the DVR's web interface: (1) **Amcrest IP Config Software method** and the **built-in interface method**.

Please note: NPAPI plugins have recently been deprecated by both Google Chrome and Firefox. To access the web user interface for your device, we recommend using Internet Explorer or Safari. Google Chrome users can use the Google Chrome extension.

For more information on how to access your device using the Google Chrome extension, visit amcrest.com/chrome

Amcrest IP Config Software method

Amcrest IP Config Software can be installed for free onto your computer from Amcrest's official website. The IP Config Software is available for both Windows and Mac operating systems. To get directly to the downloads page, use this link:

<https://amcrest.zendesk.com/hc/en-us/categories/201939038-All-Downloads>

Otherwise, the steps below will walk you through how to download, install, and use Amcrest IP Config Software:

1. Log onto your computer, open your web browser of choice, and go to www.amcrest.com:



2. Then, hover over the **Support** tab up top and choose **Apps & Software** from the dropdown.



3. This brings you to the downloads page. Click the **IP Config Software** download link on this page for either Windows or Mac.

☑ All Downloads

Mac OS

IP Config Software 

PC/Windows

★ IP Config Software 

4. Find the download in your Downloads folder and click it to open the installer.



5. You will be asked to allow this program to make changes to your computer with a pop-up window, click Yes.
6. Once you see the first page of the installer wizard, click Next to continue.



7. On the next page, check the box next to "I agree", then click Install.

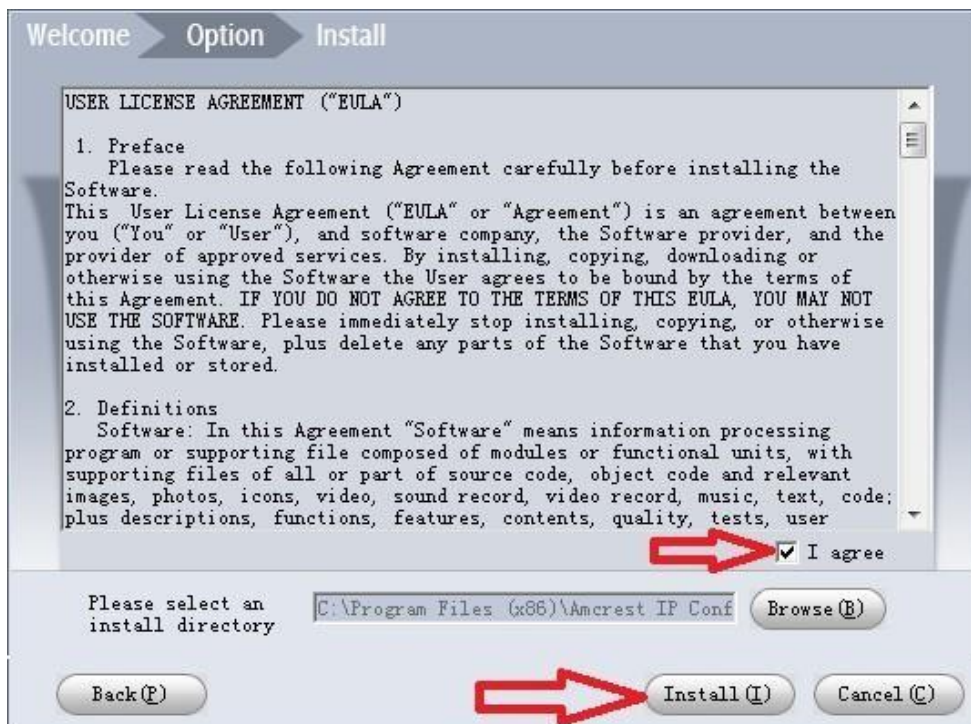

8. After the progress bar completes, if you see a Windows Security Alert popup, click **Allow access**.



9. This brings you to the main screen of Amcrest IP Config Software. Your DVR will automatically be found on your network and appear in the list (if properly connected with an Ethernet cable to your router). You will also see the IP address associated with your DVR.

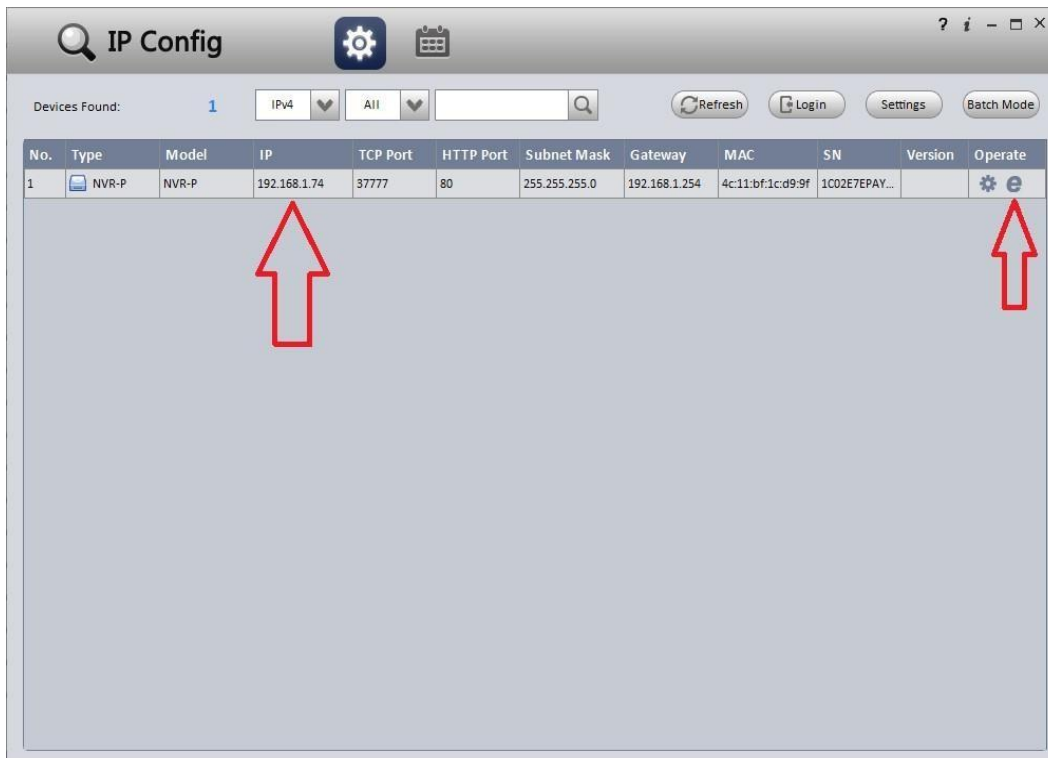

The “e” icon to the right allows you to launch directly into your web browser from this screen.

Note: This “e” icon will automatically take your DVR’s IP address and use your computer’s “default” web browser to access and log into your DVR. If your default browser is not Internet Explorer, you can write down the IP address from the Amcrest IP Config Software (IP address located above), open Internet Explorer yourself, and type that into the search bar to get to the login screen. Typing your IP address directly into the search bar will look something like this:

`http://192.168.1.74/`

Built-in interface method

1. Boot up and log into your DVR system (as explained in previous steps of this guide).
2. Left-click on the main 4-window screen to access the Main Menu, or right-click and choose it from the list.

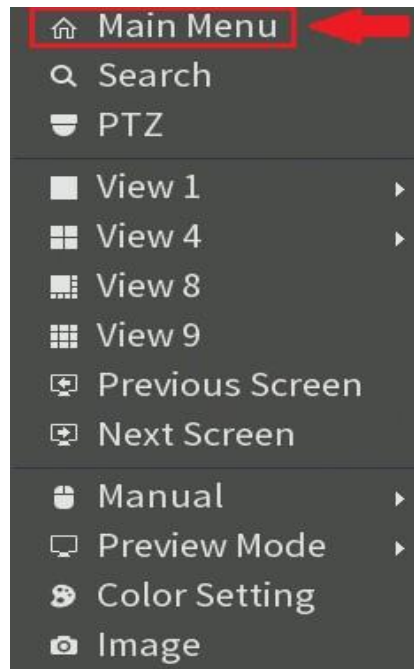

3. Click the **Network** option, in management section of the menu.
4. On the **NETWORK** settings page, you will start on the **TCP/IP** tab on the left panel list of options. Locate where it says **IP Address** on the main center page of the window.

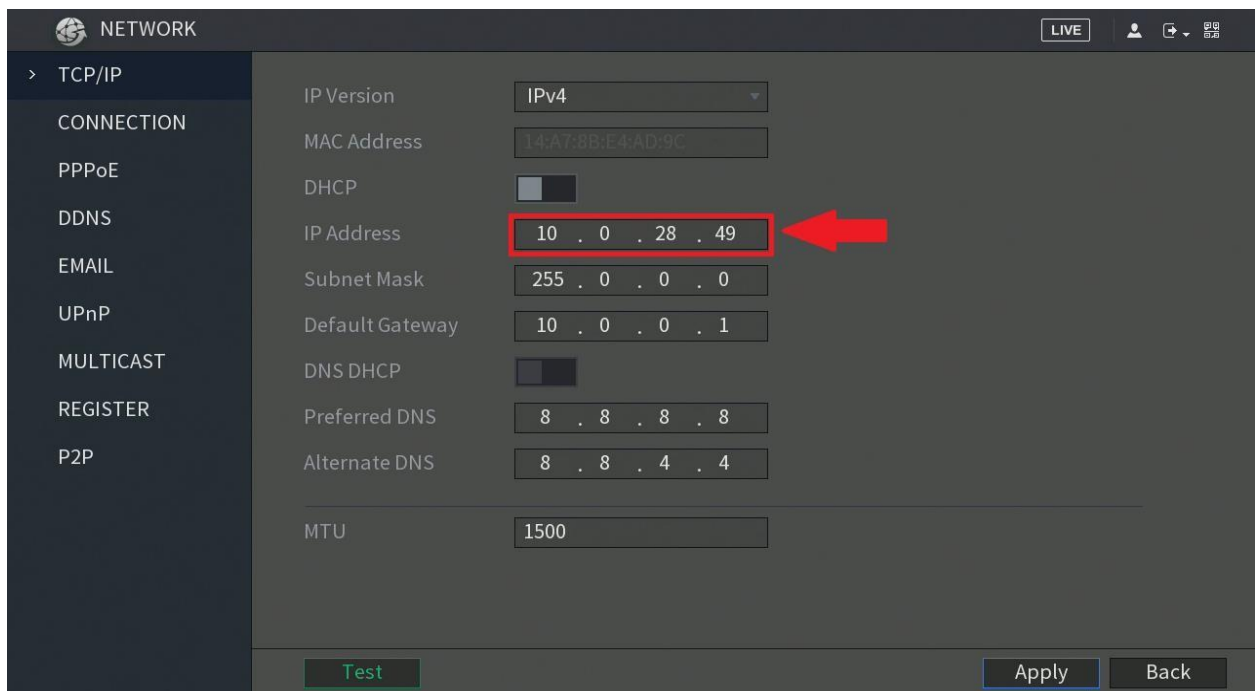

5. Write it down. It will look something like “192.168.1.74”, although it may vary depending on your network, router, or service provider.

Note: It does not matter what your IP address looks like. If your DVR is connected to your router with an Ethernet cable, and the **DHCP** checkbox is checked on the TCP/IP page, the IP address you write down will be correct.

Installing the Amcrest browser plugin

Once you've followed one of the above methods to get to the login screen for the DVR, follow the below steps to install the browser plugin on *Internet Explorer*:

1. On the main login screen, you should see a popup in the center. Click **Install**.

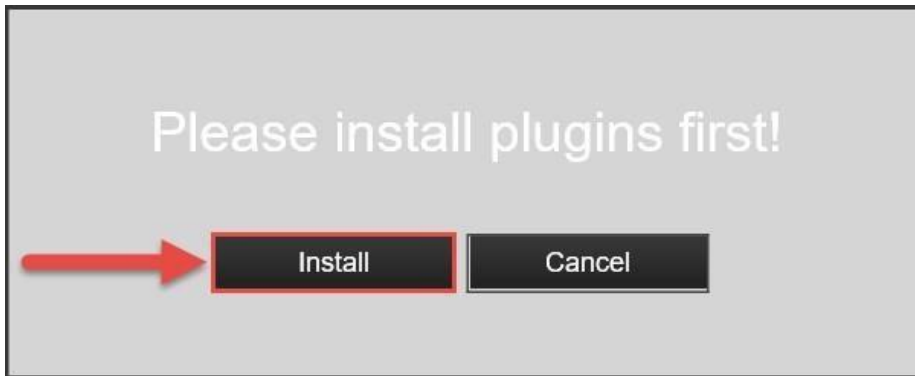

2. An install button will appear on the bottom of the screen for the plugin: **webplugin.exe**.



Click **Run**, then go through the prompts of the install wizard.

3. Once you see the notification along the bottom row. Click the small arrow to the right of the **Allow** button and select **Allow for all websites**.



4. If you see a popup window asking you to allow the plugin, mark the checkbox next to "Do not show me the warning for this program again", then click **Allow**.



Setting up DVR Local Access (home or business)

The following procedure can be done one of many ways including: using the Amcrest web interface (the most common method - that should be followed if this is your first time using this system), using the RTSP protocol to pull the video feed into a web application (like a custom website) or standalone program (like VLC media player), or using a CGI command through a web browser for a direct stream (without the need for a website or program - the DVR's CGI commands can be found through the main website - a link to this will be provided in this guide).

For the purposes of this guide, we will cover how to access the DVR through the Amcrest web interface (the most common method).

To view a video on how to setup the DVR for local access on a computer/laptop go to <http://amcrest.com/videos>, click the **Videos** tab, then find the video titled "HDCVI - Local Access Setup for PC".



Before performing the steps below to gain local access, you will need to make sure the following items are true:

1. You have your **login credentials** (if using this local access method as your first, initial choice to setup your DVR, only items **2** and **3** of this list need to be true)
2. You have located your DVR's **IP address**
3. You have installed the Amcrest **browser plugin**

To find your **login credentials**, please refer to part 3 of this guide: **Console Setup > Logging in**. Otherwise, if this is your first-time logging into the DVR and you have skipped **Step 3**, you will be able to login with the following username and password:

Username: admin

Password: admin

Note: After logging in for the first time, you will be prompted to change your password. To find the DVR's **IP address**, please refer to the **Amcrest IP Config Software method** and the **built-in interface method** sections above.

To install the **browser plugin** for the DVR's web interface, please refer to the above section: **Installing the Amcrest browser plugin**.

1. Take the IP address and type it into the Internet Explorer search bar, then hit 'Enter'. It should look something like "http://192.168.1.74:12345"

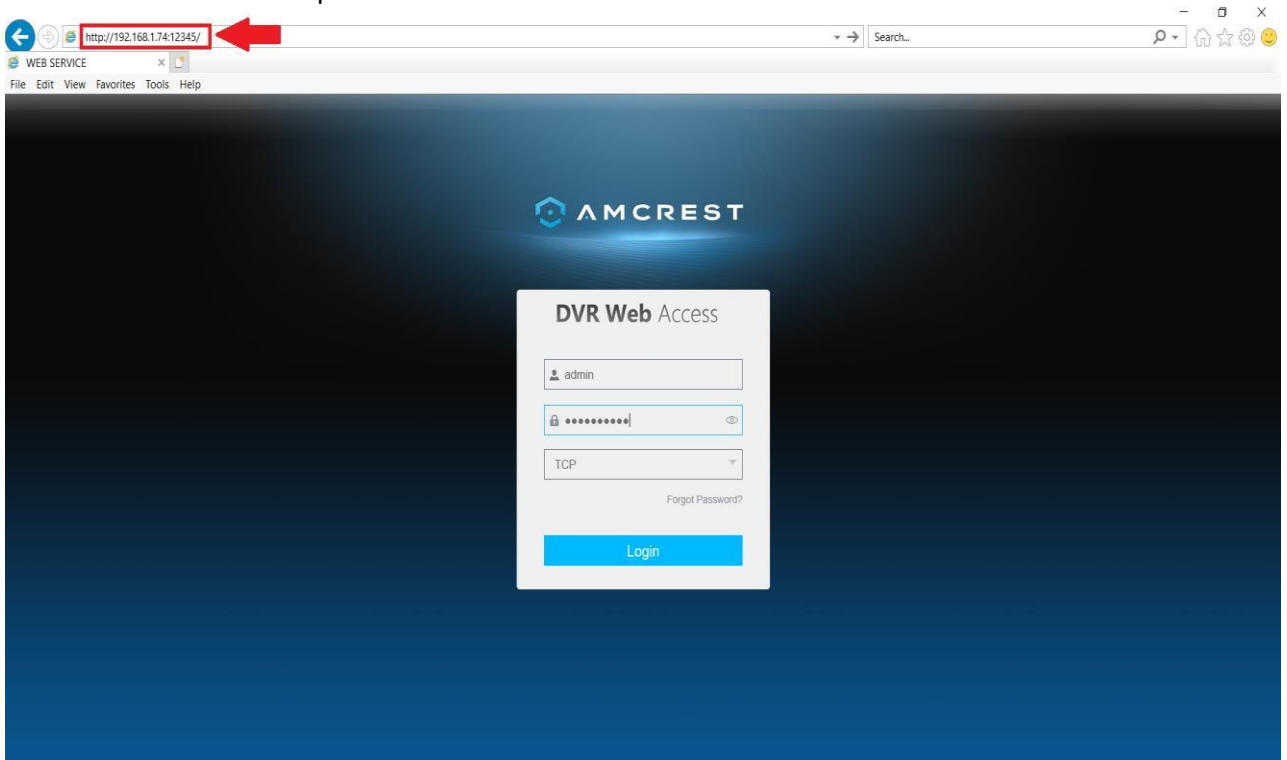

2. Enter your login credentials. You may be prompted to change your password.
3. (Optional) Save this web page as a Favorite for easy access in the future.

Setting up DVR Remote Access (away from home)

For the purposes of this guide, we will outline the most common method for setting up web access. Using Universal Plug and Play (UPnP) and Dynamic Domain Name Server (DDNS) functionality is the easiest way to setup stable remote access. For this method, your router should support the UPnP networking protocol and the protocol should be enabled. *Please note that most common routers will support this feature.* Please refer to your router's manufacturer documentation to learn how to enable UPnP on your router.

To view a video on how to setup the DVR for UPnP/DDNS remote access go to <http://amcrest.com/videos>, click the **Videos** tab, then find the video titled

"HDCVI - Remote Access Setup for PC (UPnP)".



Before performing this setup process, it is recommended that you are familiar with or have completed the steps in both part 3 '**Console Setup**' and part 5 of this guide: **Computer Access Setup > Setting up DVR Local Access**.

Below is a step-by-step walkthrough that details how to setup the DVR for remote web access using UPnP and DDNS:

1. Log in to your DVR's built-in (console) interface, open the Main Menu (by left-clicking once, or right-clicking and choosing **MAIN MENU** from the dropdown, then click **NETWORK** from the management section of the menu:

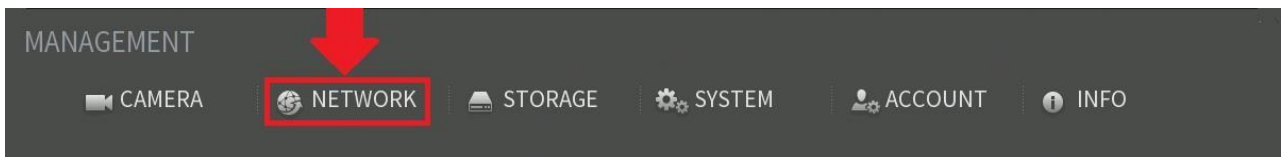

2. From the left-hand navigation panel, click **CONNECTION**, then locate the **HTTP port** on the right. It is recommended to ensure the port number is at least 5 digits long to prevent any port conflicts. You can change the port to any 5-digit number that is less than 65535 (e.g. 12345) by clicking the number field and entering a new port number. Write it down, then click **Apply**.

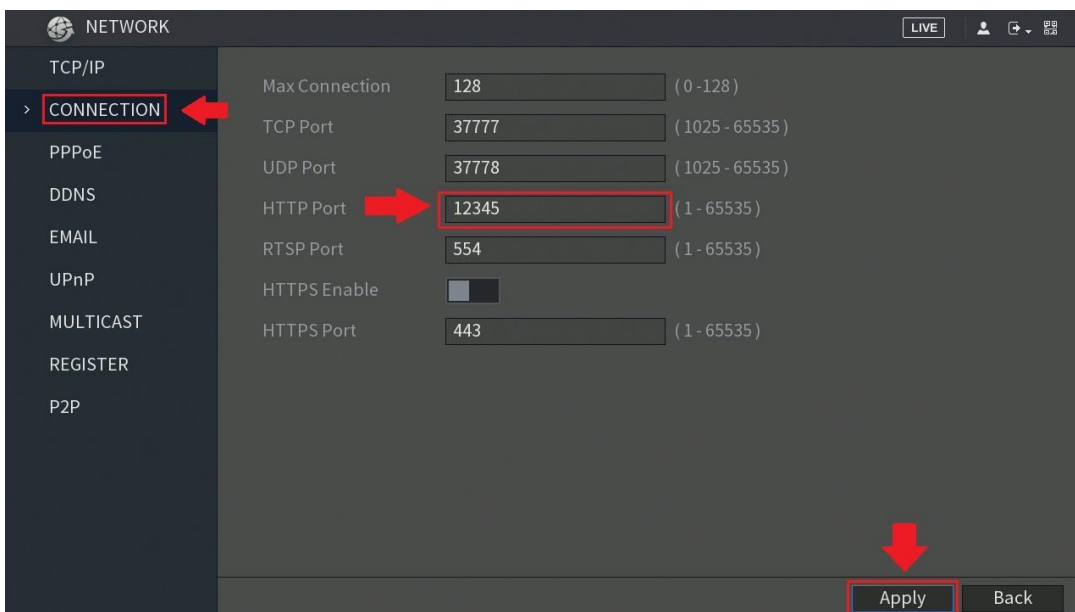

3. The system will need to reboot for this change to take effect. Click **OK**.

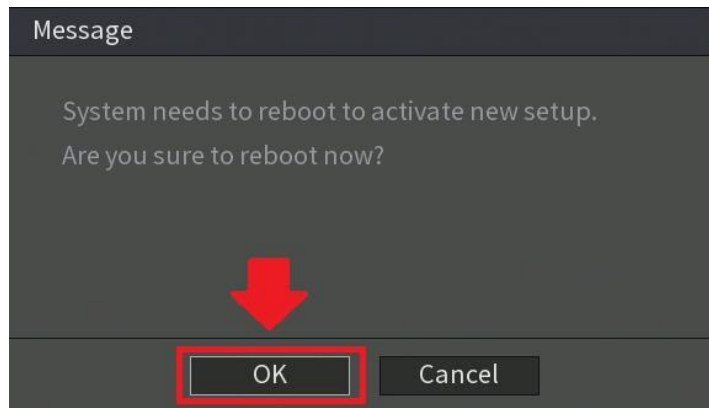

4. Once rebooted, login to your DVR again, open the **MAIN MENU**, then click **NETWORK** from the management section of the menu again.
5. Click **CONNECTION** from the left navigation panel again and ensure that the **HTTP port** has changed.
6. Next, click **DDNS** from the left navigation panel, and make sure the toggle switch for **Enable** is toggled to the on position.

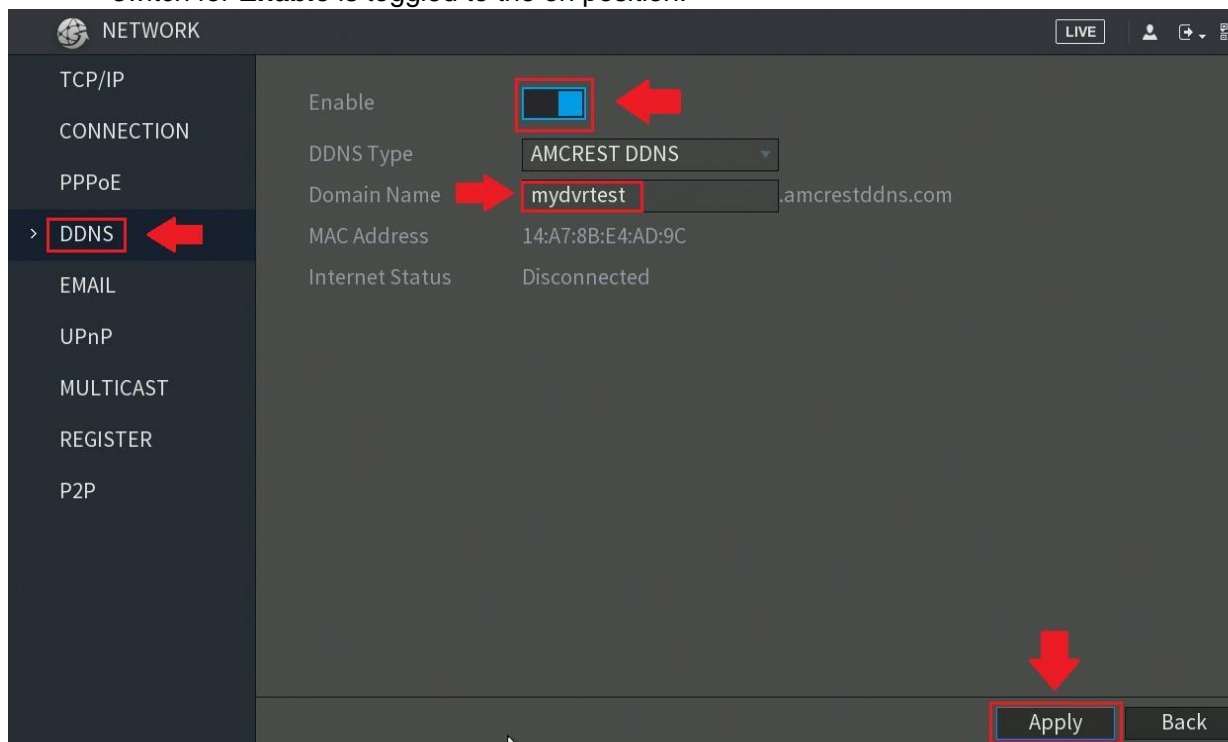

7. Create and write down the domain name for your device in the **Domain Name** field. Then, click **Apply**.
8. Click **UPnP** from the left navigation panel and select the **PAT** radio button at the top to the on position. Then, locate row **1** in the **PAT Table**, where **HTTP** is written beneath **Service Name Protocol**, and click the edit icon to change the **HTTP Ext. Port**.

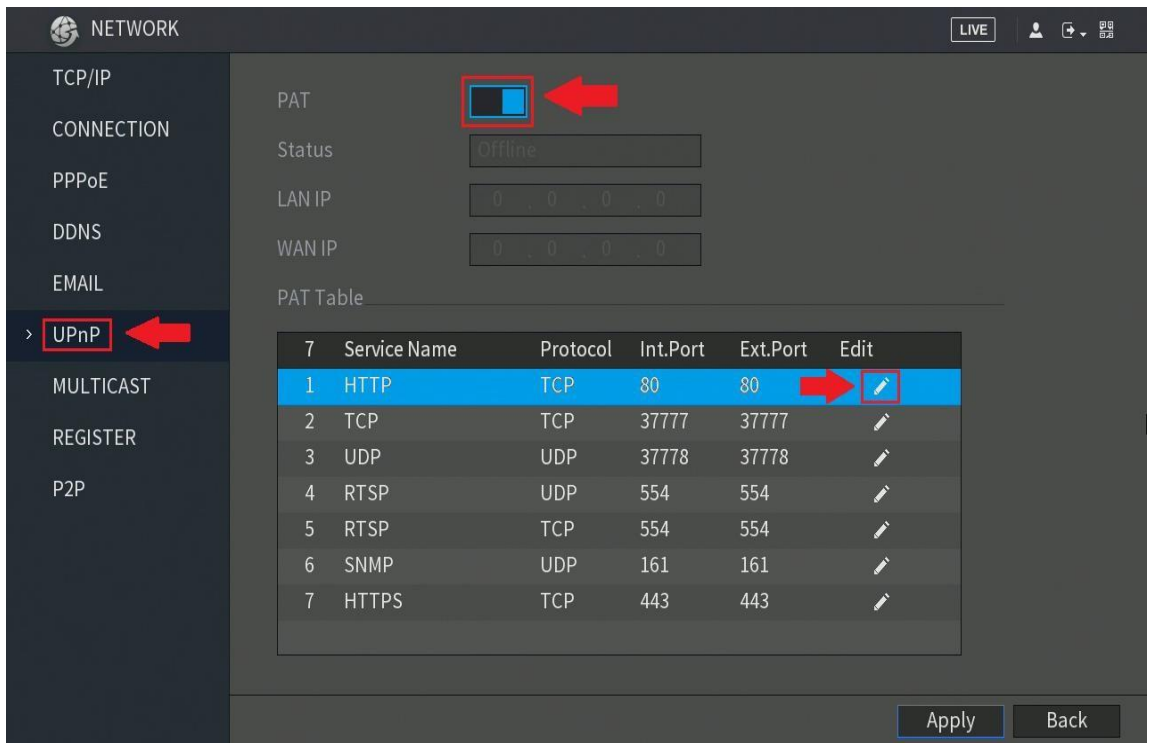

- In the **PORT INFO** window that appears, click into the number field next to **Ext. Port** to change it to the same port number that was chosen in step 2 above (e.g. 12345). Then click **OK**.



- Now, click **Apply**, and ensure it says 'Searching' in the field next to **UPnP Status**.

UPnP Status Searching

- Exit this menu to go back to the main menu, then re-enter the UPnP menu, and ensure the **UPnP Status** says 'Success'.

UPnP Status Success

Note: If this does not say 'Success', try resetting the DVR, then your router. If it still does not work, it may be because your router does not support UPnP. In this case, you will need to **port forward** to gain remote access. Please read step 5: **Check for UPnP** below, in the **troubleshooting steps** that follow this guide for more information on what to do next.

12. Open a web browser and enter in the DDNS domain name address from step 7, enter in a colon ":" (without quotes), then type the port number from step 2 onto the end.
 - a. For example, if the DDNS domain name is `http://mydvrtest.amcrestddns.com` and your HTTP Port is 12345, the URL would be <http://mydvrtest.amcrestddns.com:12345>
13. The browser may prompt you to install a plugin. Click install to download the plugin, then click on the plugin installation file to install the plugin.
14. Enter your login credentials into the username and password fields.
15. Ensure the web access protocol is set to **TCP**, and then click **Login**.



To get more detailed information on other methods to set up remote web access for the Amcrest DVR, please refer to the user manual.

Remote access not working? (troubleshooting steps)

1. **Re-enter login credentials:** Confirm that your username and password for accessing the DVR are correct. Please refer to part 3 of this guide: **Console Setup > Logging in**. The same credentials you use to log in to the console in that section are what you will enter into the login screen on the web interface.
2. **Use the correct web browser:** Make sure you are using Internet Explorer as your web browser.

3. **Confirm plugin is installed:** If you still see any popup windows when trying to log in to the web interface, please make sure you have correctly installed the Amcrest browser plugin: **webplugin.exe**. Please refer to part 5 of this guide: **Computer Access Setup> Installing the Amcrest browser plugin**.
4. **Write the URL correctly:** When using Internet Explorer, it is crucial to write the DVR's remote access URL correctly. Some versions of Internet Explorer will not automatically include the "http://" prefix to the beginning of an IP address that is typed in. Check your search bar and, if you do not see "http://" before your URL (e.g. 192.168.2.149:12345), please add it. In addition to that, make sure that you are using a *colon* ":" and not a *semicolon* ";". Your final URL should look something like this: "<http://192.168.2.149:12345/>" (without quotes). Keep in mind that the IP address and port number will be different depending on your setup.
5. **Select WAN button:** The **LAN** radio button will be selected by default. You must click and select **WAN** in order for this remote connection to work.
6. **Connect to the internet:** Confirm that your computer is properly connected to the internet by loading another web page first, then trying the DVR's remote access URL again. Also, confirm that an Ethernet cable is connected from your router to the correct port on the back of your DVR. Please refer to part 2 of this guide: **Front/Back Panel Diagrams & Descriptions**.
7. **Check for UPnP:** In order for remote access to work, UPnP has to be enabled on your DVR *and* it has to be enabled and supported on your router. Check your router's documentation to confirm whether UPnP is supported. Otherwise, an alternative to UPnP is **port forwarding** which can be done by following a video tutorial for the HDCVI system. To find this video, go to <http://www.amcrest.com/videos/> and find the video by clicking **Playlists**.

To contact Amcrest support, please do one of the following:

- o Visit <http://amcrest.com/contacts> and use the email form
- o Call Amcrest Support using one of the following numbers Toll Free:
(888) 212-7538
International Callers (Outside of US): +1-713-893-8956
USA: 713-893-8956
Canada: 437-888-0177
UK: 203-769-2757
- o Email Amcrest Customer Support support@amcrest.com

Web Interface Walkthrough

The web interface several different options:

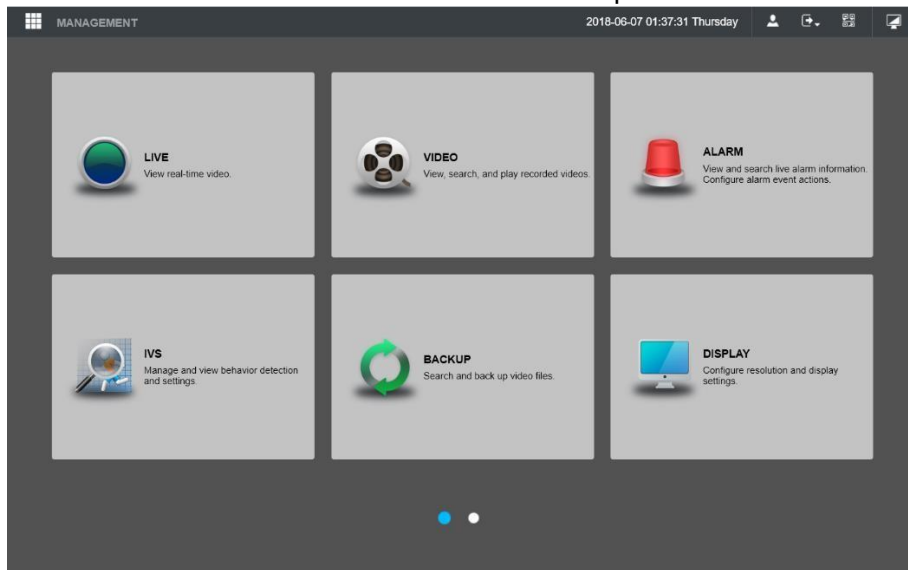

Live – Allows you to access real-time video and camera options. You can also control PTZ and image settings, as well as view cameras in full screen.

Video – Allows you to view, search and playback recorded videos retained in the system's hard drive. **Alarm** – Allows you to view and search live alarm information and notifications. You can also configure alarm event actions in this menu.

IVS – Allows you to manage and set IVS and intelligent detection settings (if applicable). **BACKUP**: Allows you to search and backup video data via a external USB or flash drive.

DISPLAY: Allows you to configure resolution and display output settings.

AUDIO – Located on the next page, allows you to configure audio announcements and import audio files.

Management

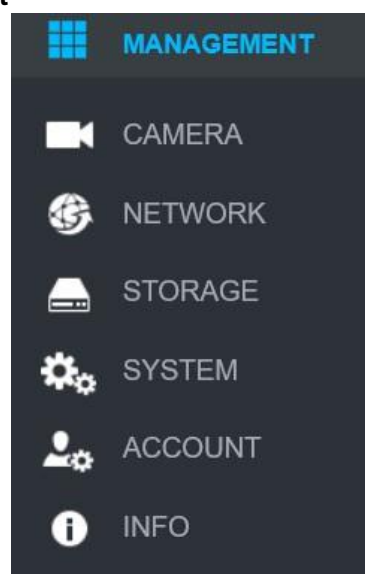

CAMERA: Review or edit settings for each camera, including video settings (e.g. quality, bit rate, color, etc.).

NETWORK: Review or edit network settings for the DVR (e.g. email, DDNS, UPnP, etc.) **STORAGE:** Review or edit storage parameters and settings. (e.g. motion detection, alarm, etc.). Set HDD detection as well as setup FTP settings.

SYSTEM: Review or edit system parameters or configuration, including system maintenance, factory resets and firmware upgrades.

ACCOUNT: Review admin accounts and add new users to device. (e.g. ONVIF users).

INFO: Review system, log, network, HDD and channel information (e.g. Bps and connectivity)

7. Amcrest View App Setup

The Amcrest View app grants instant access to all live camera streams from any location. This is the primary application most users prefer when using Amcrest systems. The app supports a multitude of features and includes both a plug-and-play setup as well as a manual network setup. For purposes of this guide, we will use Amcrest View Pro, which is free on both the App Store and Play Store.

Before accessing the DVR through the app using the easy plug-and-play method (P2P Setup), **confirm that P2P is enabled on the DVR**. This feature should be enabled by default.

Enabling P2P on the DVR

1. Log into your DVR console's built-in interface using the DVR login credentials.
2. Open the **MAIN MENU** by left-clicking the DVR's home preview screen. Then, click **NETWORK** in the bottom **MANAGEMENT** section located in this menu.

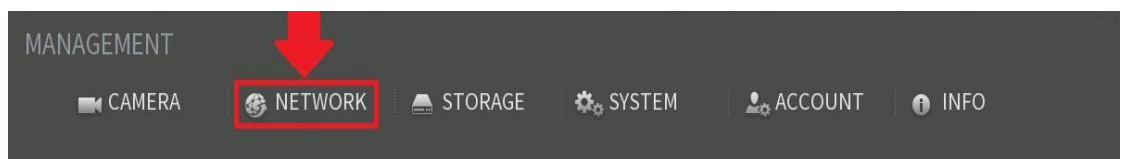

3. Select **P2P** from the left navigation panel's list of options. Make sure the checkbox next to **Enable** is checked. If it is not, check it, then click **Apply** and **Save**.
4. Exit out of the main menu, then come back to the **P2P** page and confirm that the **Status** is 'Online'.

Amcrest View Pro Setup

The following steps will continue the app setup process for an Android phone and, though the iPhone version of the app has slightly different steps, most of this process is identical and easy.

1. Download and open the Amcrest View Pro app from the App Store or Play Store.



2. Open the app and tap on the (+) symbol in the middle of the screen to begin adding your DVR.

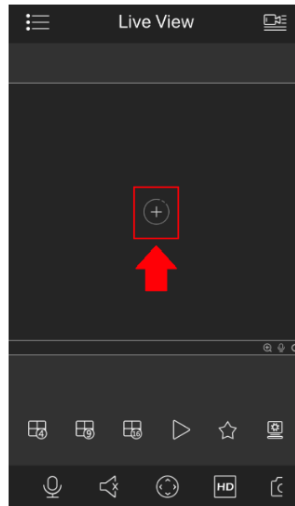

3. Tap on **Add Device**.

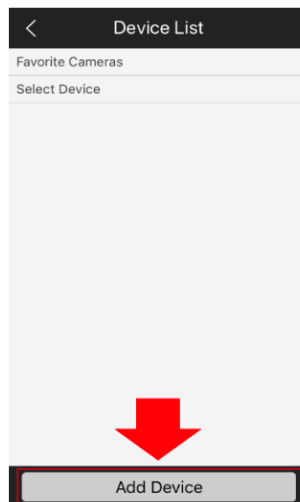

4. Tap on **DVR/NVR**.



5. Next, we will need to select a connection type. Since we will be setting up a basic P2P connection with the device, tap on "**P2P Connection**" to continue.



6. Scan the QR code  for your device. This code can be found on or near the device's serial number tag. If the QR code does not scan or you are unable to access it, the application provides you a means of entering your serial number manually. Tap on "**Enter S/N Manually**" to enter the information.



7. Give the device a name and provide the username and password. The default username and password will be **admin**. Tap **Start Live View** to continue.

Note: You can tap on the  icon to verify the password.

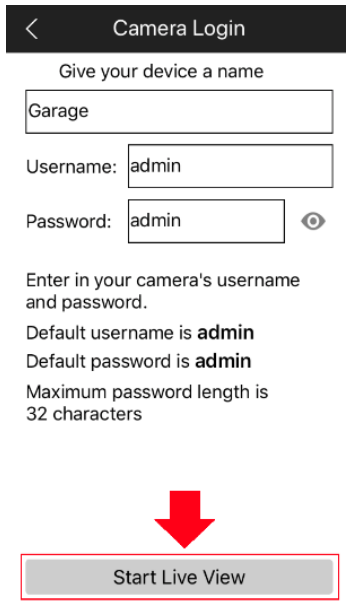

9. The app will prompt you to change the password. Enter a password between 8 and 32 characters and confirm the password. Press **OK** to continue.

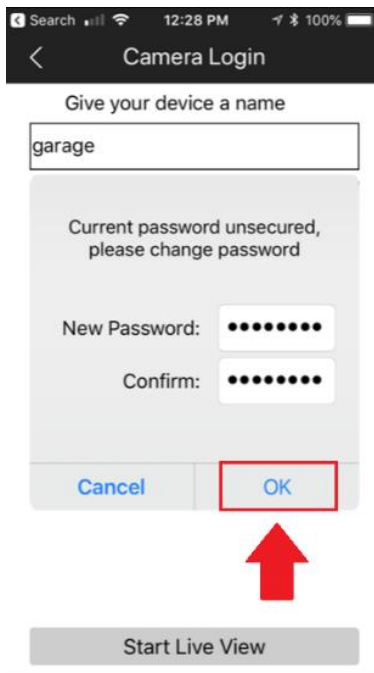

10. Your device is now set up and ready for use on the app.



For setup without establishing a P2P connection in the app you will need to use IP Domain/DDNS setup. For more details on this setup visit, amcrest.com/support

App setup not working? (troubleshooting steps)

1. **Re-enter login credentials:** Are you getting a (quote 'incorrect password' error) message? Try double checking your username and password. These will be the same credentials used to log into the DVR console's built-in interface.
2. **Confirm your phone is online:** Make sure that your phone is receiving a strong WiFi or cellular data signal. Confirm the Internet connection is working by loading a webpage or testing another internet enabled app.
3. **Confirm the DVR is online:** Make sure an Ethernet cable is connected from your router to the Internet port on the back panel of your DVR console. (For help with this, refer to part 2 of this guide: **Hardware Setup > Setting up the cable connectons.**)
4. **Confirm P2P is enabled:** To use the P2P Setup to gain plug-and-play instant access, P2P needs to be enabled on the DVR. It will be enabled by default. To confirm P2P is enabled, log into the main console built-in interface for your DVR and select Network from the Main Menu (in the Settings row). Then, click P2P from the left navigation panel (on the bottom). Make sure the checkbox is checked next to "Enabled". If it is not, check it, click Apply down below, then attempt the P2P App Setup again (tap Start Live Preview).
5. **Confirm the serial number:** if you entered the serial number manually, double check that it is correct and re-enter it. This does not apply if you used the QR code scan.

6. Still not working?

If you have tried all of the above troubleshooting steps, try rebooting your DVR. Then, restart your phone and try the P2P Setup on your app again. Contact support if you are still unable to gain access.

To view a video on how to setup the Amcrest DVR for remote access on a smartphone or tablet, go to <http://amcrest.com/videos> and view the video titled

“How to Setup Amcrest HDCVI DVR for Remote Access on Smartphone/Tablet”.



Amcrest View Pro interface overview

Once the app is setup to work with your DVR, it should look like the image below on the left. Here, you will be able to access all crucial functions like taking snapshots, manual recordings, etc.

Clicking the Menu Icon on the top left-hand corner will open the menu for this app, and it should look like the image below on the right.

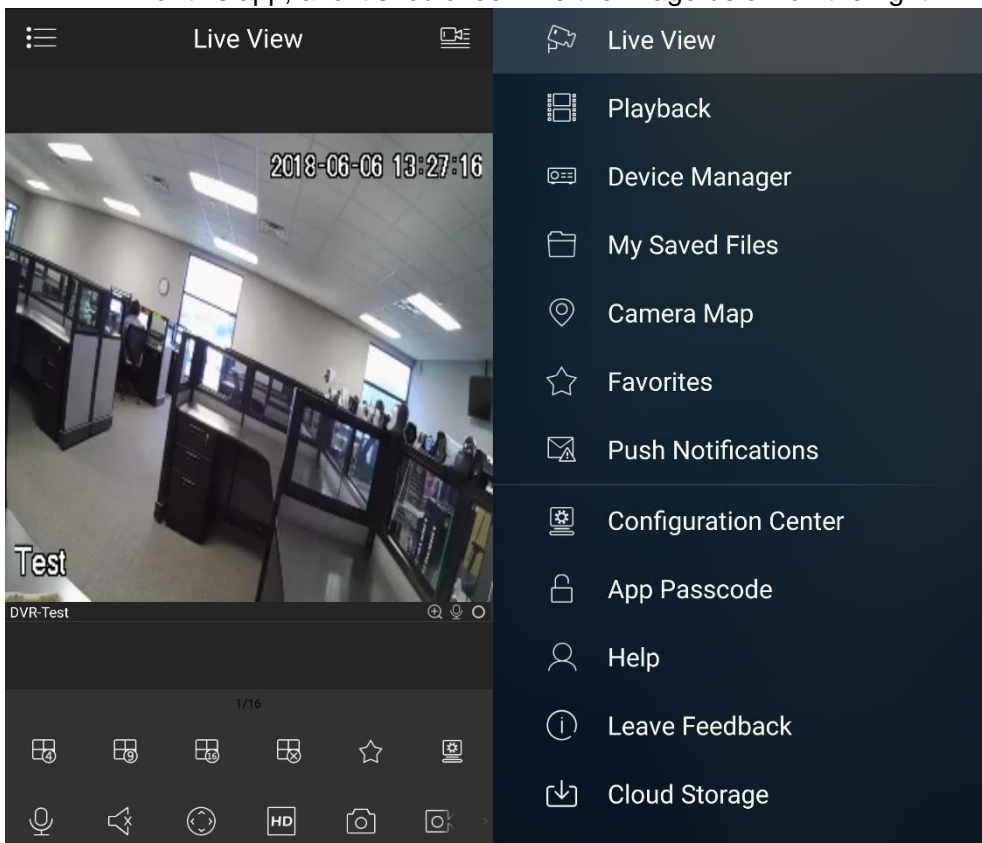

Live Preview is the default screen that the app opens on, but from the menu, **Playback**, and **Device Manager** can be opened, as well as other menu items for other features.

Note: For help identifying and understanding app features, either tap the icon to see a tooltip description, or open the main menu, then tap **Help** to learn more.

8. Amcrest View Web Portal Setup

You can access your DVR through a computer using the P2P web portal **AmcrestView.com** for quick plug-and-play access. It uses the same technology as the Amcrest View mobile app and is an easy, non-technical setup method.

There are 2 methods of accessing your DVR using AmcrestView.com: the **user method** (registering an account for login), and the **device method** (instant direct access using the serial number).

Both methods require that the Amcrest **browser plugin** be installed for AmcrestView.com.

Installing the AmcrestView.com browser plugin

1. Open Internet Explorer, type "www.amcrestview.com" into the search bar, and hit Enter. This will take you to the login screen:

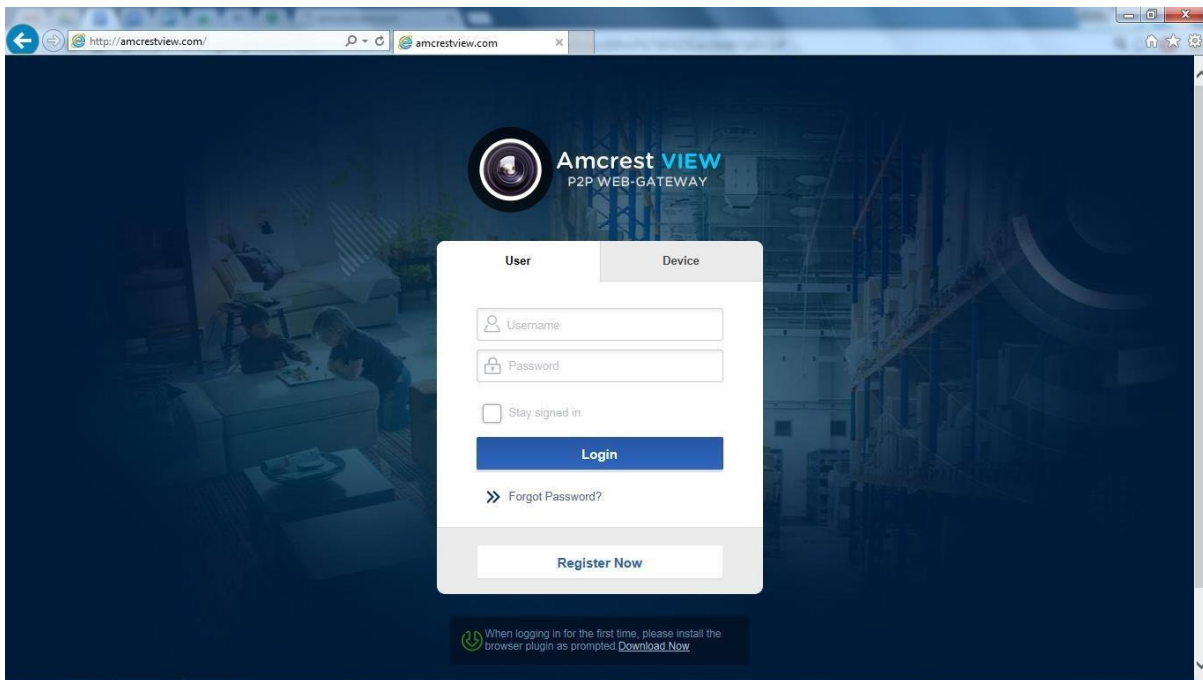

2. Once you're on the login page, you will see a message about installing the plugin below the login box. Click **Download Now**:



3. This will take you to another page where you will need to click the **Download Now** button:

Setup **Web Client** Plugin

In order to use AmcrestView.com, you must first install/update the ActiveX plugin.

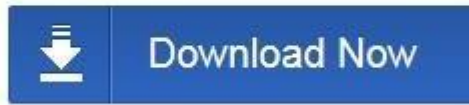

Please restart the browser after upgrade.

4. You will be prompted by the browser to install the plugin. Click **Run**:



5. You may be prompted to verify this download. This software is not harmful to your computer and will not make any unwanted changes. To verify, start by clicking **View Downloads**:



6. In the View Downloads page, right click the plugin, then click **Run Anyway**.

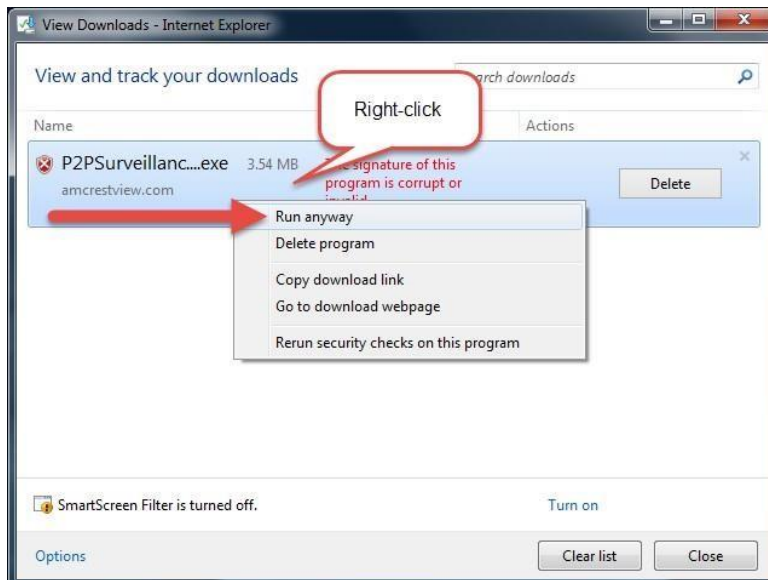

7. The plugin will close your browser sessions to install. Save any pages, then click **Yes**:





8. On the next prompt, it will say the install was successful and ask you to restart your browser. Click **OK**:

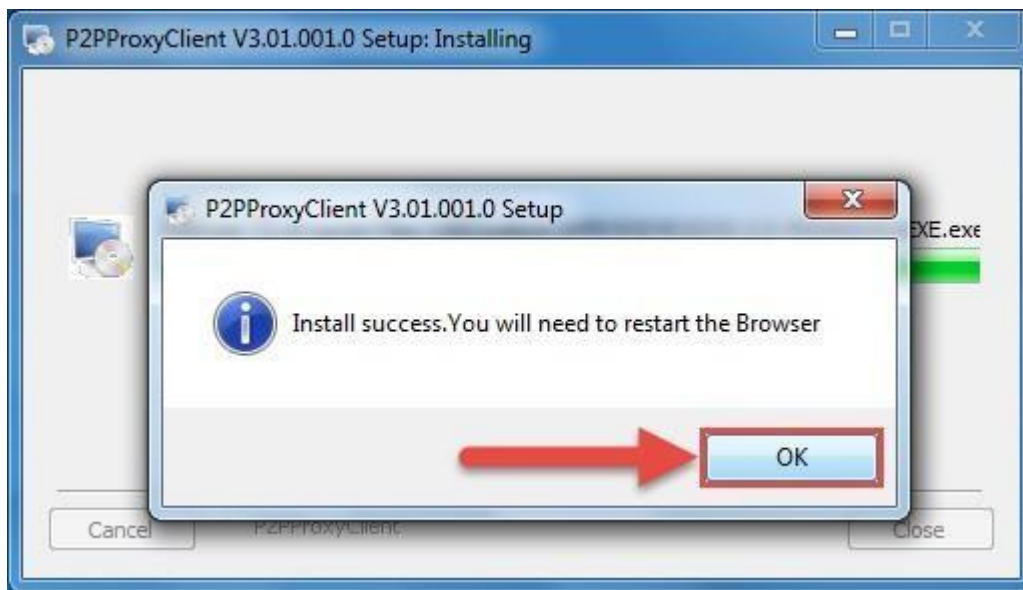

9. You will be taken back to the login page and see another notification from your browser asking you to allow this plugin on this web page. Click the small arrow next to **Allow**, then click **Allow for all websites**:

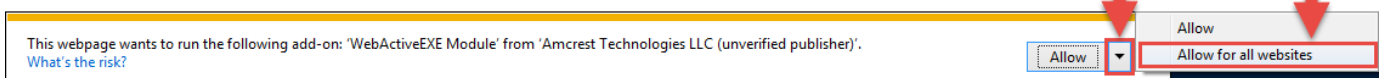

10. Another popup will appear asking you to allow this plugin. Mark the checkbox next to **Do not show me the warning for this program again**, then click **Allow**:



Now the plugin has been installed successfully and you can continue to register for an account for DVR access through AmcrestView.com

User method

The **user method** requires that you first install the Amcrest browser plugin for AmcrestView.com. Then, you can register for an account to set up your DVR.

1. On the main login screen, www.amcrestview.com, click the **Register Now** button:

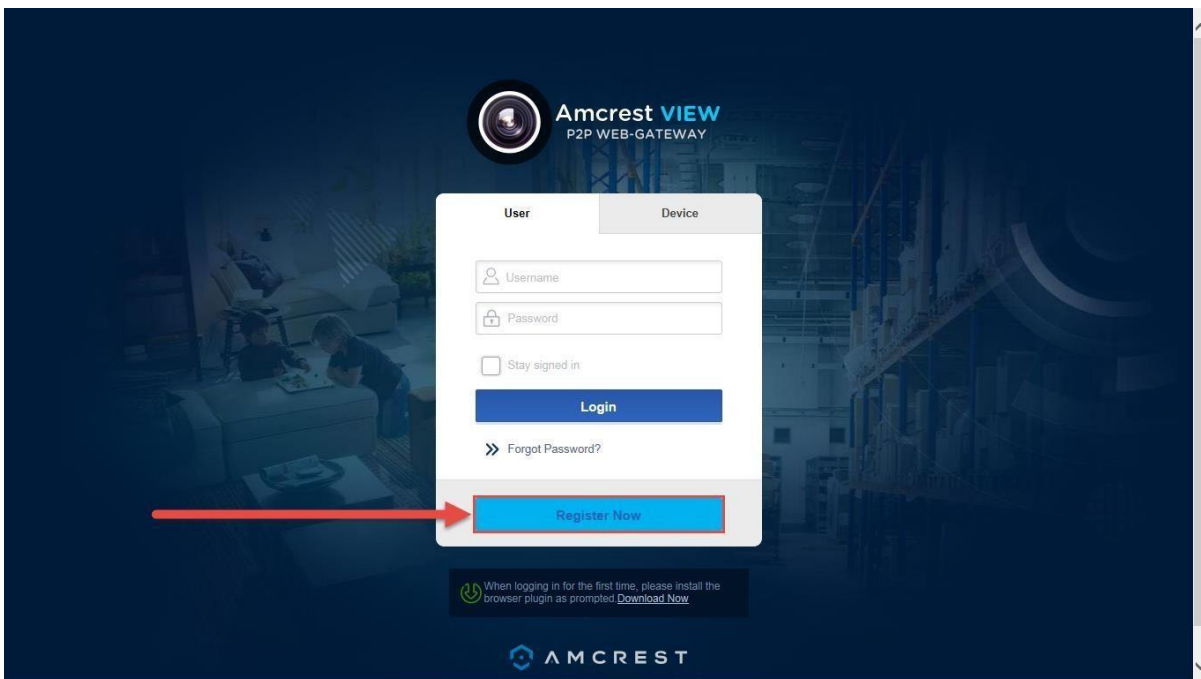

2. You will be taken to the registration form. Enter your **Username**, **Password**, then **Confirm Password**, type your **Email**, enter the

Verification Code, make sure the box is checked confirming you've read the 'Amcrest Terms of Service', then click **Create an Account**:

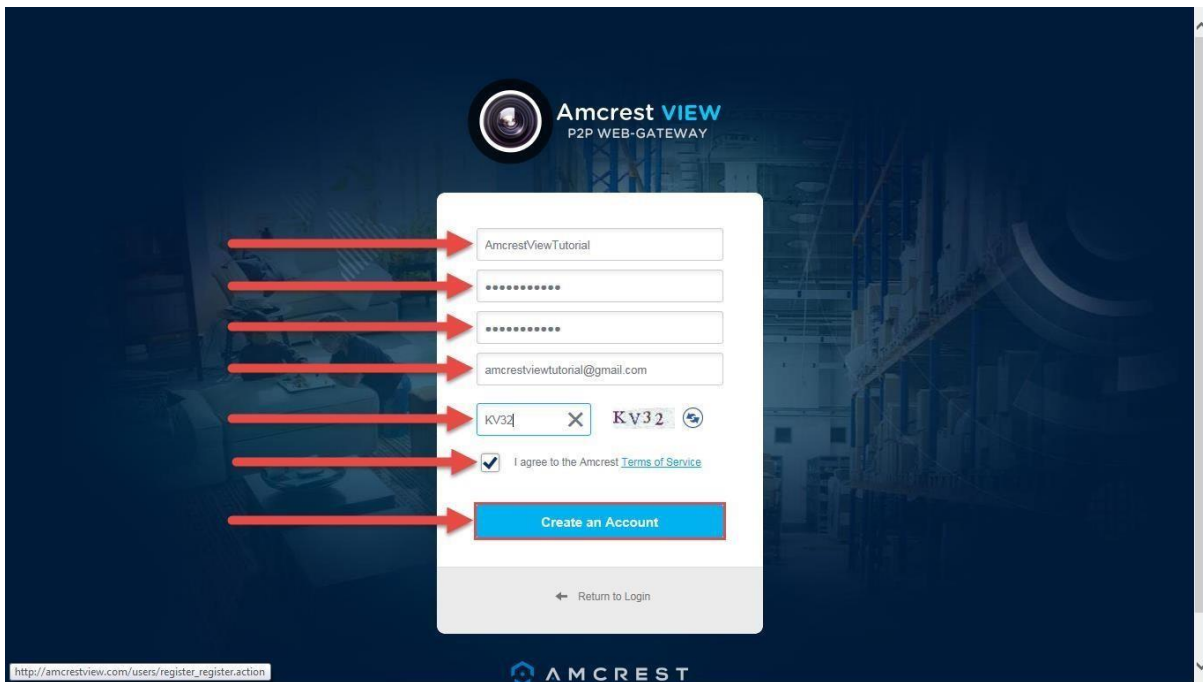

3. You will see the **Registration Successful** message and a confirmation email will be sent to you:

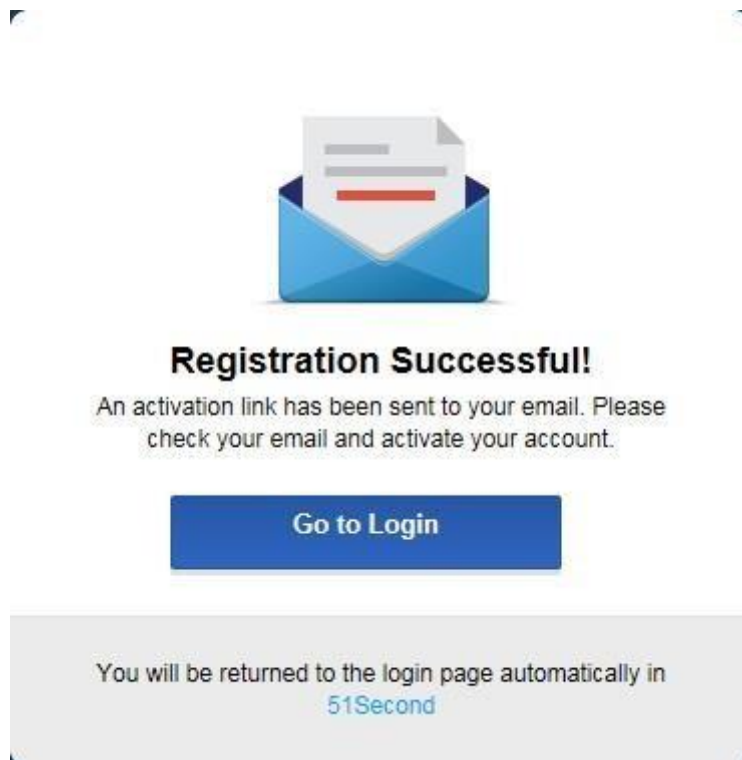

Check your email, and click the confirmation email from AmcrestView.com:

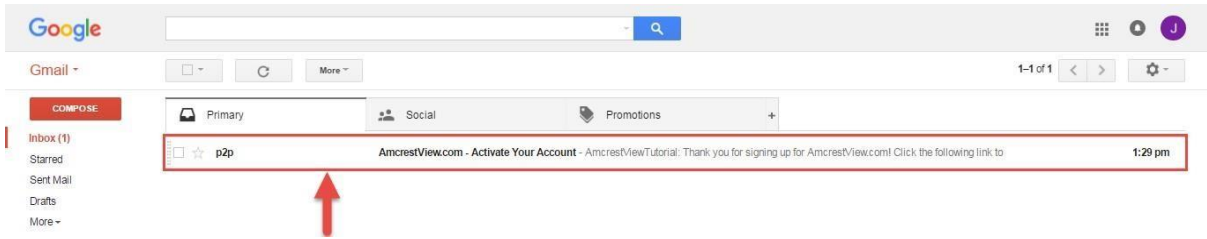

4. Once you've opened the email, click the confirmation link inside to complete your registration:

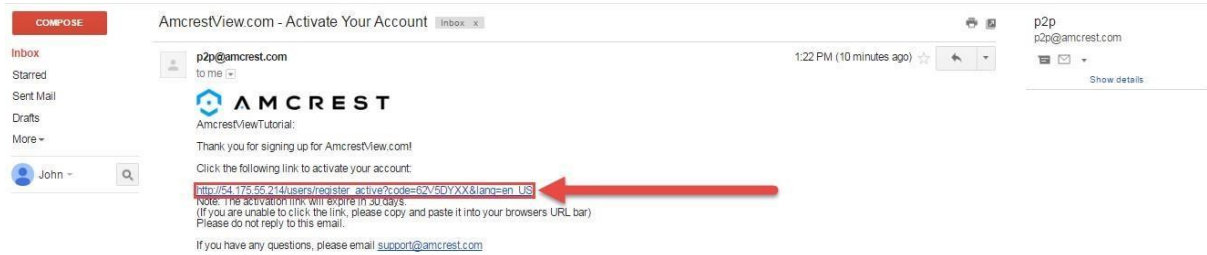

5. You will be taken back to AmcrestView.com and shown confirmation that your account has been activated. Click **Go to Login**:

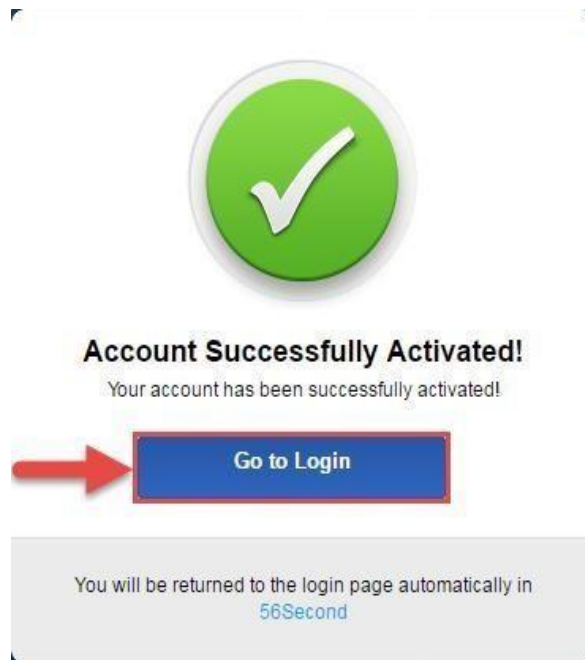

6. You will be taken back to the login screen. Enter your new AmcrestView.com username and password, then click **Login**:

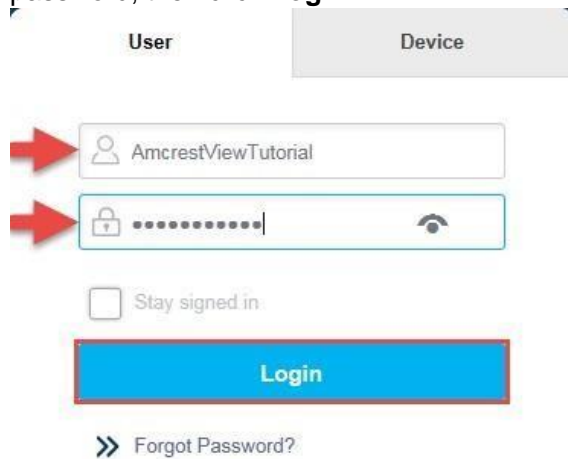

User Device

AmcrestViewTutorial

Stay signed in

Login

>> Forgot Password?

7. A popup will appear from your Windows Firewall. Click **Allow access**:

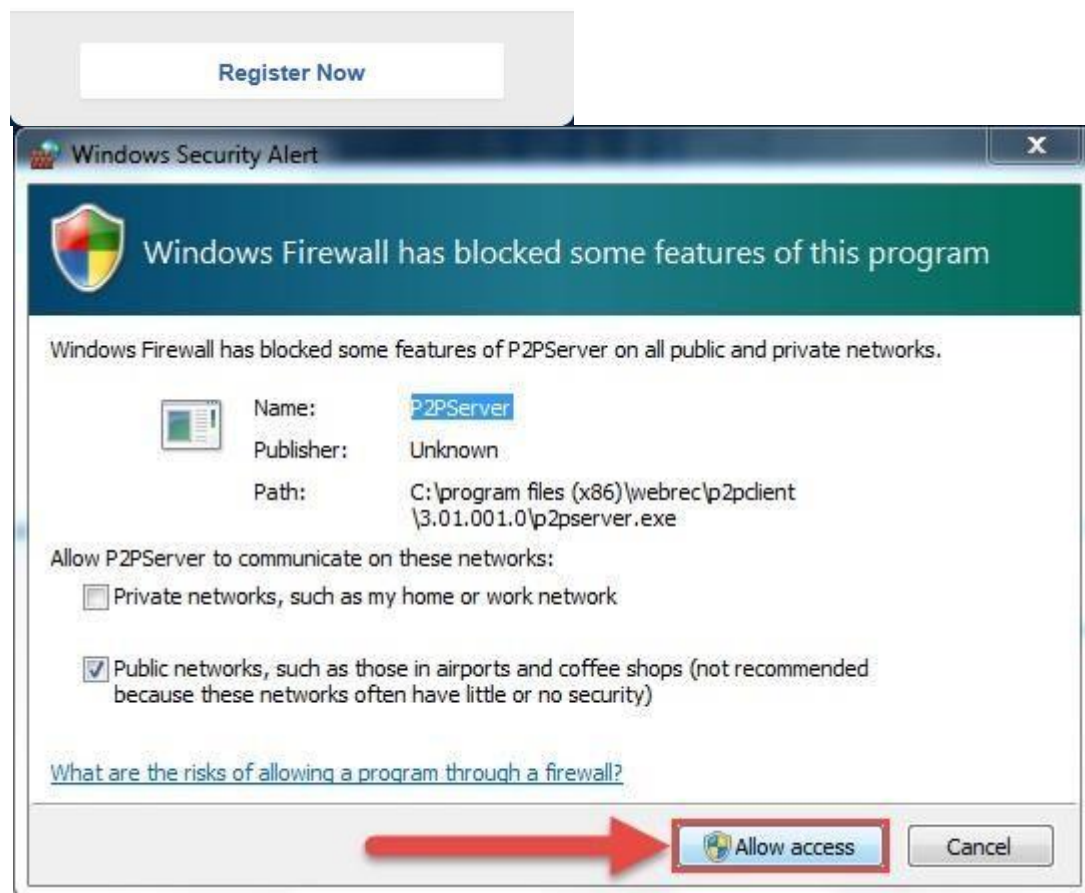

8. You will be taken to the main screen of your account. From here, click the **Add Device** button:

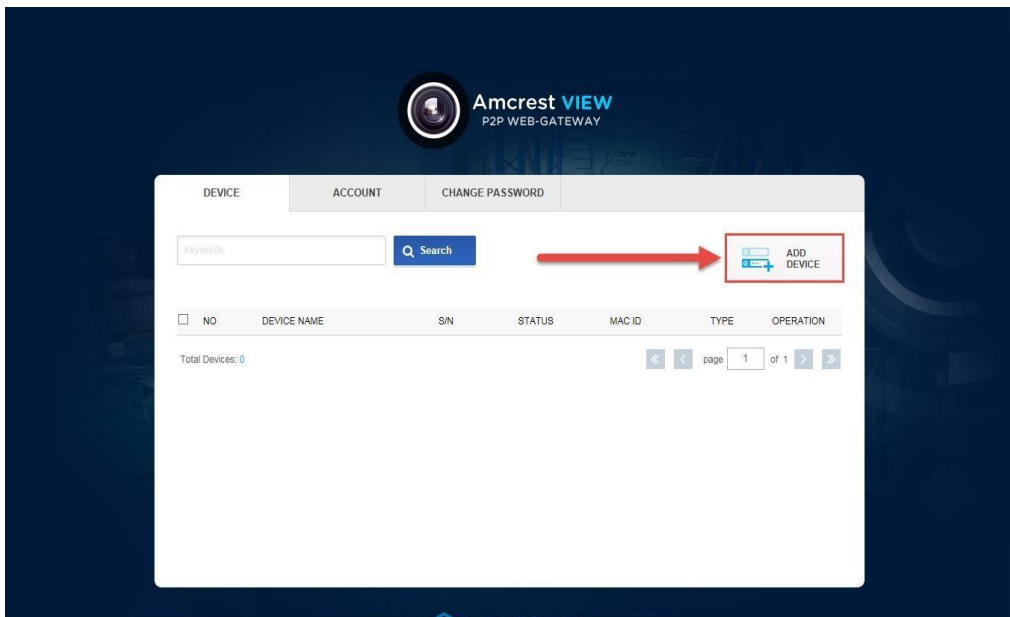

- Now you can enter your DVR's information. Enter a **Device Name** (this can be anything). Then, fill in the **S/N** (serial number) this can be found on the sticker attached to the bottom of your DVR or through the web interface.

Enter your username and password for the DVR, not the username and password you just created for AmcrestView.com. To find your DVR login credentials, please refer to part 4 of this guide: **Console Setup (Login & Startup Wizard) > Logging in**. Finally, click **OK**:

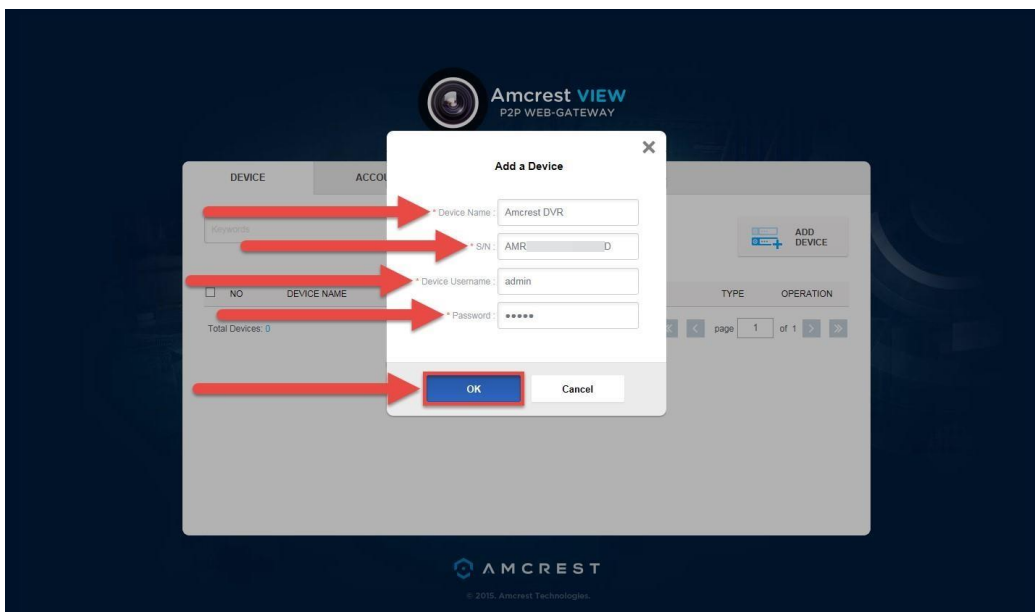

- You will then see your DVR added to the device list on the main screen. Click the 'eye' icon to view the live feed:

DEVICE		ACCOUNT	CHANGE PASSWORD				
Keywords		Search		ADD DEVICE			
NO	DEVICE NAME	S/N	STATUS	MAC ID	TYPE	OPERATION	
1	Amcrest DVR	AMR10380DLP06L460D	●	4c-11-bf-36-aa-76	HCVR		
Total Devices: 1				page 1 of 1			

11. Your browser will give you a notification asking you to allow popups from AmcrestView.com. Click **Options for this site**, then click **Always allow**:



12. You will be taken to the live view page and given a notification to allow the plugin to pull the video feed through here. Click the small arrow to the right of **Allow**, then click **Allow for all websites**:

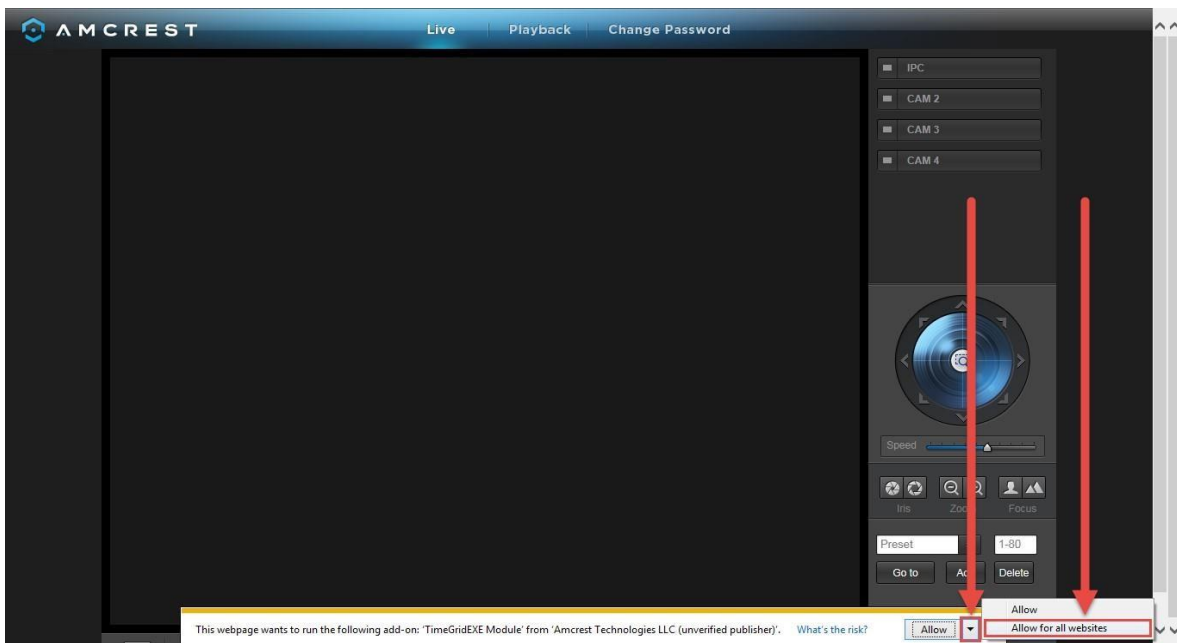

13. A final popup will appear asking you to confirm that you allow this plugin on your browser. Mark the checkbox next to **Do not show me the warning for this program again**, then click **Allow**:



14. Now you can enable any of your added cameras to see their live feeds. In the top-right panel, there is a channel list. Click the small square icon to enable your feed for an added camera to see the video feed:



Click the “S” to change it to an “M” which stands for “Main Stream” and will give you a full HD quality video stream. To go back to “Sub Stream”, for lower quality video (that works better on slower internet connections), click the “M” and change it to an “S” again.

Device method

To login to your DVR quickly, without having to register, you can use the **device method**. This method still requires that you install a plugin, which is covered above, but can be done with only the DVR's login credentials and the **serial number**.

1. On the main login screen for AmcrestView.com, click the **Device** tab:

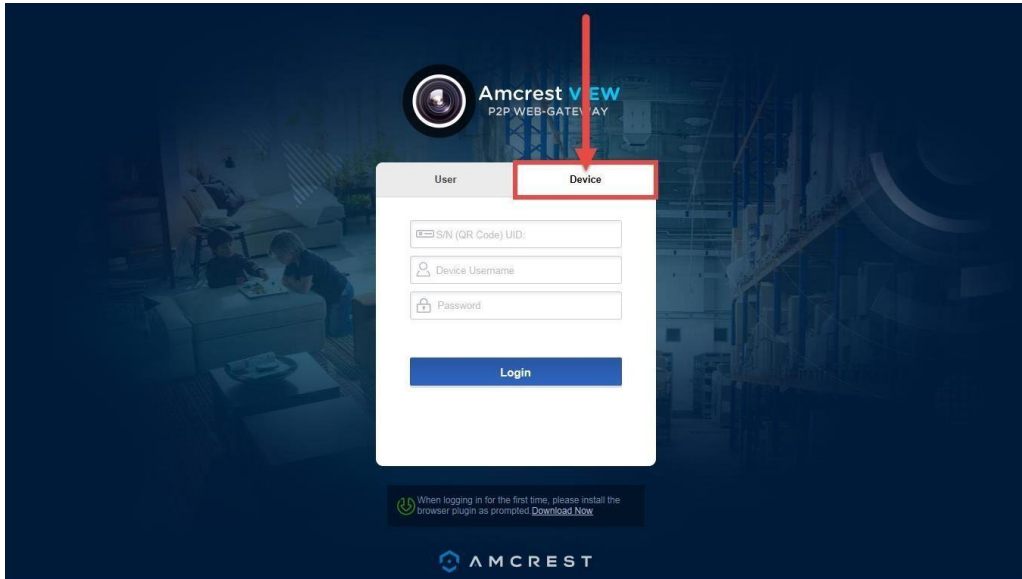

2. Enter your DVR's **S/N**(serial number) into the top field, enter your DVR's username and password, then click **Login**.

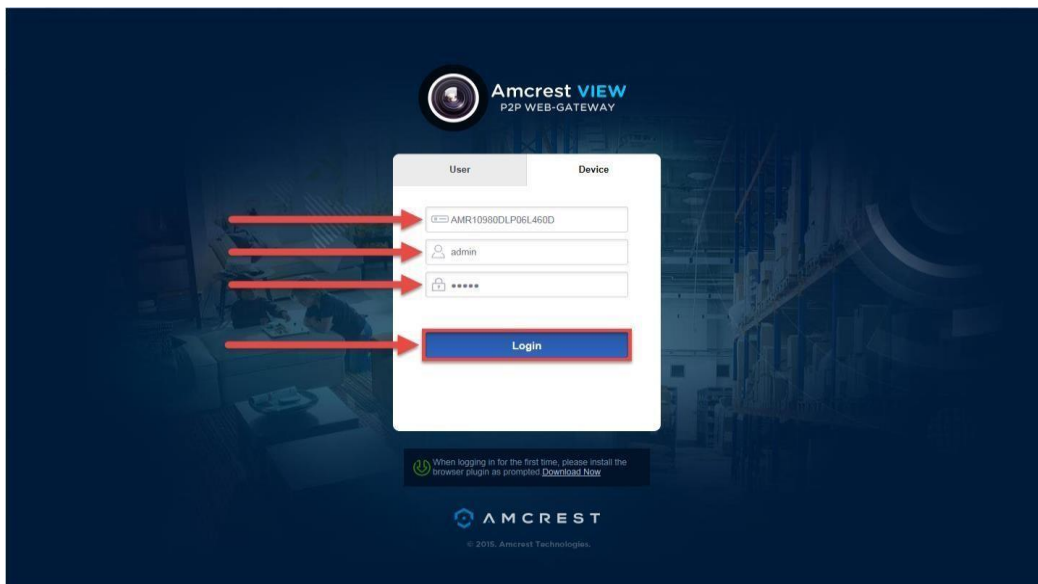

To find your DVR's login credentials, please refer to part 4 of this guide: **Console Setup (Login & Startup Wizard) > Logging in**.

3. This will take you straight to the live view screen. You will see a notification from your browser asking you to allow the plugin. Click

the small arrow to the right of **Allow**, then click **Allow for all websites**:

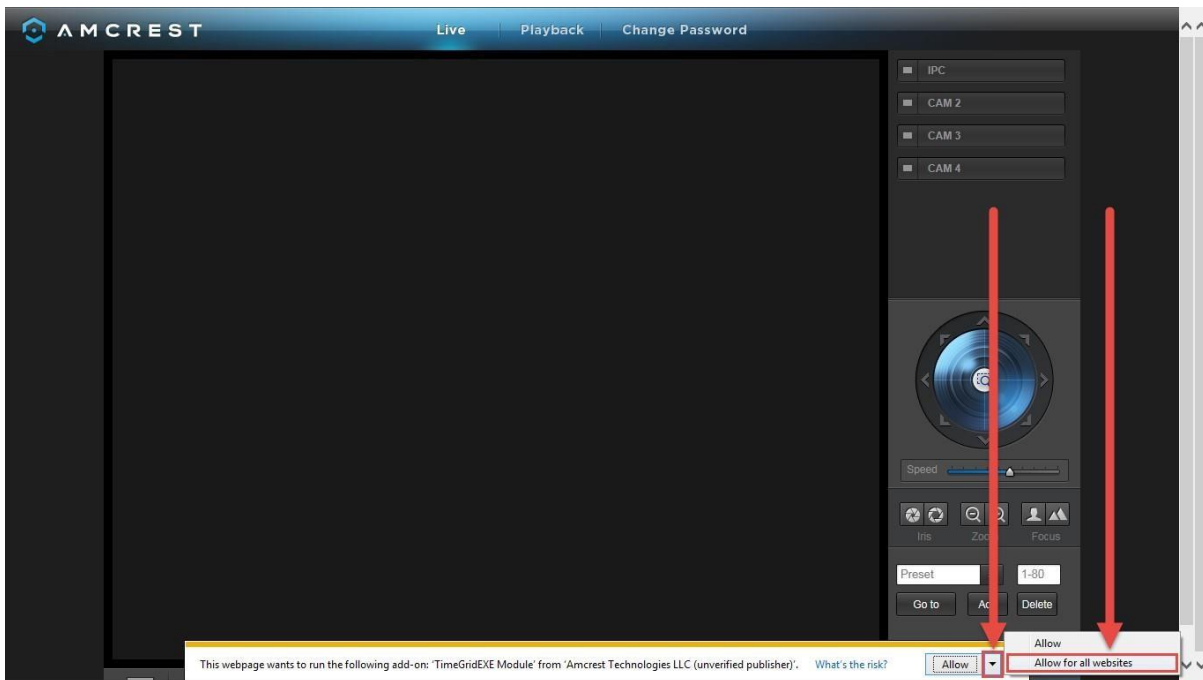

4. You will see a popup asking you to confirm that you allow this plugin. Check the box next to **Do not show me the warning for the program again**, then click **Allow**:



5. Now you can enable any of your added cameras to see their live feeds. In the top-right panel, there is a channel list. Click the small

square icon to enable your feed for an added camera to see the video feed:



Click the “S” to change it to an “M” which stands for “Main Stream” and will give you a full HD quality video stream. To go back to “Sub Stream”, for lower quality video (that works better on slower internet connections), click the “M” and change it to an “S” again.

AmcrestView Web Interface Overview

There are two main sections inside of the AmcrestView web interface: the main **device list section** (for anyone logged in with a registered account) and the **live view section** (can be accessed by both registered users and those accessing their DVRs using the **device method** covered above).

Device list section

The device list section has 3 main tabs. The first is the **DEVICE** tab:

DEVICE ACCOUNT CHANGE PASSWORD

Keywords

<input type="checkbox"/>	NO	DEVICE NAME	S/N	STATUS	MAC.ID	TYPE	OPERATION
<input type="checkbox"/>	1	Amcrest DVR	AMR10380DLP06L460D	●	4c-11-bf-36-aa-76	HCVR	

Total Devices: 1 page 1 of 1

This page shows you a list of any added devices and is where you can click the 'eye' icon to view your DVR's live camera feeds. This is where you can **ADD DEVICE**, **Search**, edit, or delete your added devices.

The next tab is the **ACCOUNT** tab:

DEVICE ACCOUNT CHANGE PASSWORD

Username:

country:

Email:

Receive email from AmcrestView.com

This is where you can see your **Username**, change your **Country**, see your **Email**, and enable email notifications from AmcrestView.com.

The last tab for the device list section is the **CHANGE PASSWORD** tab:

DEVICE	ACCOUNT	CHANGE PASSWORD
Old Password:	<input type="password"/>	
New Password:	<input type="password"/>	
Confirm Password:	<input type="password"/>	
<input type="button" value="OK"/> <input type="button" value="Cancel"/>		

Here, you can change your password.

Live view section

The live view section is where you can see the live camera feeds and playback footage for any cameras added to your DVR. The first tab is the **Live** tab:



Here, you can enable the live feeds for any connected cameras, control PTZ, take snapshots, use 2-way audio, view them in full screen, and more.

The next tab is the **Playback** tab.

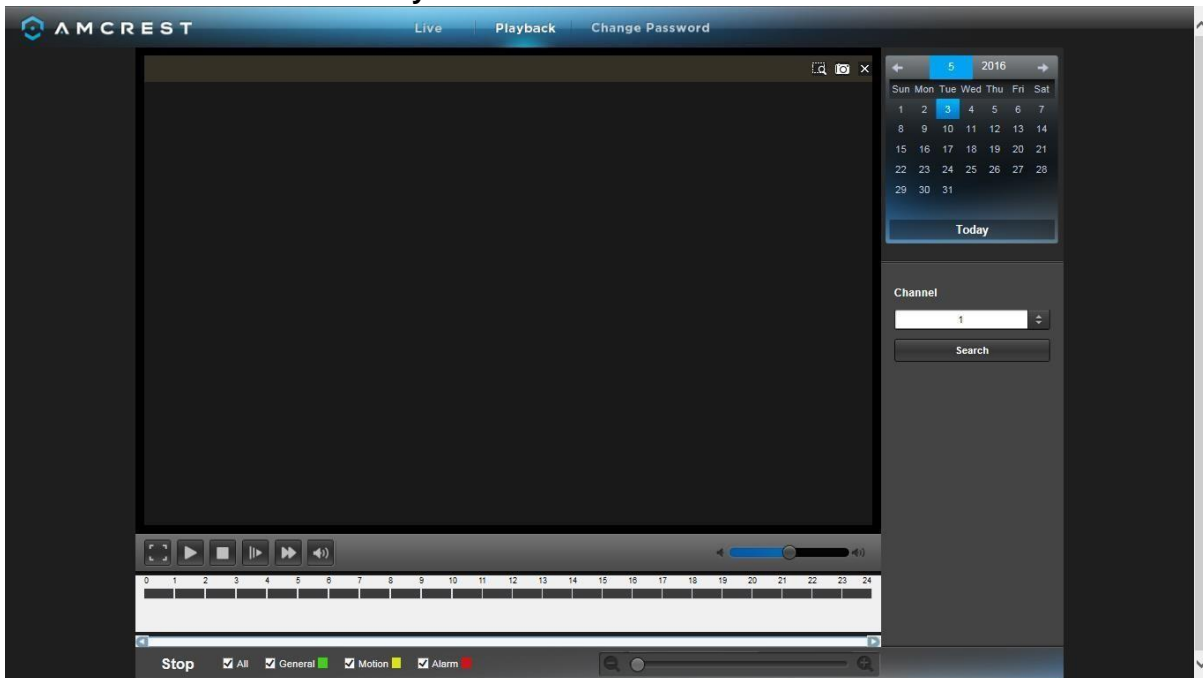

Here, on the right panel, there is a calendar for you to choose which day you'd like to see footage from, and you can choose a channel to select which camera you want to see footage from. The timeline on the bottom allows you to play, stop, forward, etc.

Note: Keep in mind that you can see the live feeds from your cameras whether a hard drive is installed in your DVR. However, you will need to have a hard drive installed and recordings properly configured to view the playback.

9. References & Contact Information

To view setup videos for many of the steps outlined in this guide, go to <http://amcrest.com/videos>

This quick start guide is for reference only. Slight differences may be found in the user interface.

All the designs and software here are subject to change without prior written notice.

All trademarks and registered trademarks mentioned are the properties of their respective owners.

If you have any questions or concerns, please contact us at support@amcrest.com, or call us at 888-212-7538.

FCC Statement

1. This DVR complies with Part 15 of the FCC Rules. Operation is subject to the following two conditions: (1) this DVR may not cause harmful interference, and (2) this DVR must accept any interference received, including interference that may cause undesired operation.

2. The user's manual or instruction manual for an intentional or unintentional radiator shall caution the user that changes, or modifications not expressly approved by the party responsible for compliance could void the user's authority to operate the equipment. In cases where the manual is provided only in a form other than paper, such as on a computer disk or over the Internet, the information required by this section may be included in the manual in that alternative form, provided the user can reasonably be expected to have the capability to access information in that form.

3. (b) For a Class B digital DVR or peripheral, the instructions furnished the user shall include the following or similar statement, placed in a prominent location in the text of the manual:

NOTE: This equipment has been tested and found to comply with the limits for a Class B digital DVR, pursuant to Part 15 of the FCC Rules. These limits are designed to provide reasonable protection against harmful interference in a residential installation. This equipment generates, uses and can radiate radio frequency energy and, if not installed and used in accordance with the instructions, may cause harmful interference to radio communications. However, there is no guarantee that interference will not occur in a particular installation. If this equipment does cause harmful interference to radio or television reception, which can be determined by turning the equipment off and on, the user is encouraged to try to correct the interference by one or more of the following measures:

- Reorient or relocate the receiving antenna.
- Increase the separation between the equipment and receiver.
- Connect the equipment into an outlet on a circuit different from that to which the receiver is connected.
- Consult the dealer or an experienced radio/TV technician for help.

4. RF exposure warning

This equipment must be installed and operated in accordance with provided instructions and the antenna(s) used for this transmitter must be installed to provide a separation distance of at least 20 cm from all persons and must not be co-located or operating in conjunction with any other antenna or transmitter. End-users and installers must be provided with antenna installation instructions and transmitter operating conditions for satisfying RF exposure compliance.

IC Warning Statement

This DVR complies with Industry Canada's licence-exempt RSSs. Operation is subject to the following two conditions:

- (1) This DVR may not cause interference; and
- (2) This DVR must accept any interference, including interference that may cause undesired operation of the DVR.

Le présent appareil est conforme aux CNR d'Industrie Canada applicables aux appareils radio exempts de licence. L'exploitation est

autorisée aux deux conditions suivantes : (1) appareil ne doit pas produire de brouillage, et (2) l'utilisateur de l'appareil doit accepter tout brouillage radioélectrique subi, même si le brouillage est susceptible d'en compromettre le fonctionnement.

This equipment complies with IC RSS-102 radiation exposure limits set forth for an uncontrolled environment. This equipment should be installed and operated with a minimum distance of 20cm between the radiator and any part of your body.

Pour se conformer aux exigences de conformité CNR 102 RF exposition, une distance de séparation d'au moins 20 cm doit être maintenue entre l'antenne de cet appareil et toutes les personnes.

Copyright © Amcrest 2018