

# **VEVOR<sup>®</sup>**

**TOUGH TOOLS, HALF PRICE**

Technical Support and E-Warranty Certificate [www.vevor.com/support](http://www.vevor.com/support)

## **CABLE RAILING POST**

**MODEL:HR-001/HR-002/HR-003/HR-004/HR-005/HR-006/HR-007/  
HR-008/HR-009/HR-010/HR-011/HR-012/HR-013/HR-014  
HR-015/HR-016/HR-017/HR-018/HR-019/HR-020/HR-021/  
HR-022/HR-023**

We continue to be committed to provide you tools with competitive price.

"Save Half", "Half Price" or any other similar expressions used by us only represents an estimate of savings you might benefit from buying certain tools with us compared to the major top brands and does not necessarily mean to cover all categories of tools offered by us. You are kindly reminded to verify carefully when you are placing an order with us if you are actually saving half in comparison with the top major brands.

# VEVOR®

TOUGH TOOLS, HALF PRICE

## CABLE RAILING POST

MODEL:HR-001/HR-002/HR-003/HR-004/HR-005/HR-006/HR-007/  
HR-008/HR-009/HR-010/HR-011/HR-012/HR-013/HR-014  
HR-015/HR-016/HR-017/HR-018/HR-019/HR-020/HR-021/  
HR-022/HR-023

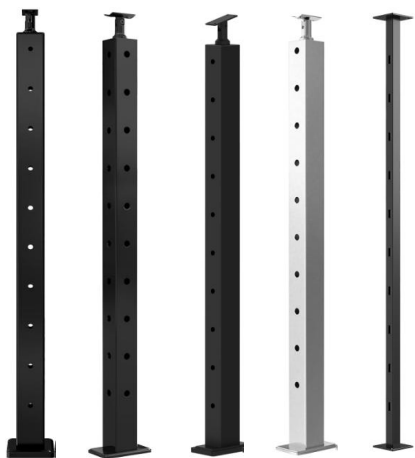

<Picture Only For Reference >

### NEED HELP? CONTACT US!

Have product questions? Need technical support? Please feel free to contact us:

**Technical Support and E-Warranty Certificate**  
[www.vevor.com/support](http://www.vevor.com/support)

This is the original instruction, please read all manual instructions carefully before operating. VEVOR reserves a clear interpretation of our user manual. The appearance of the product shall be subject to the product you received. Please forgive us that we won't inform you again if there are any technology or software updates on our product.

## IMPORTANT SAFEGUARDS



**WARNING:** Read and understand this entire manual before operating or servicing this product. Failure to follow these warnings and instructions can cause personal injury or damage to valuable property.

- 1.The warning indicates that appropriate action should be taken to avoid the potential danger of personal injury.
- 2.Product capabilities apply to properly and completely assembled product only.
- 3.Please keep small spare parts out of children's reach,it is not a toy, Do not allow children to play.
4. For additional information regarding the parts listed in the following pages, please refer to the Assembly Diagram of this manual. Unwrap and separate all parts in a clean work area.

**SAVE THESE INSTRUCTIONS**

## MAIN FEATRUES

This product is mainly used for column installation of wire functions and decorative accessories.

VEVOR's Cable Railing Post is made of all stainless steel materials, which has great resistance to rust and corrosion. It will work for long life time for interior and exterior railings with low maintenance. Please note that it is not recommended for coastal projects.

We work with every effort to provide quality products and professional service, and make VEVOR a reliable brand.

## INSTALLATION INSTRUCTION

**Installation indication and Applicable post**

Applicable to all engineering installation scenarios.

**Note:** This product only includes the column and its installation fasteners, excluding wire rope, Cable Railing Kit, handrail.

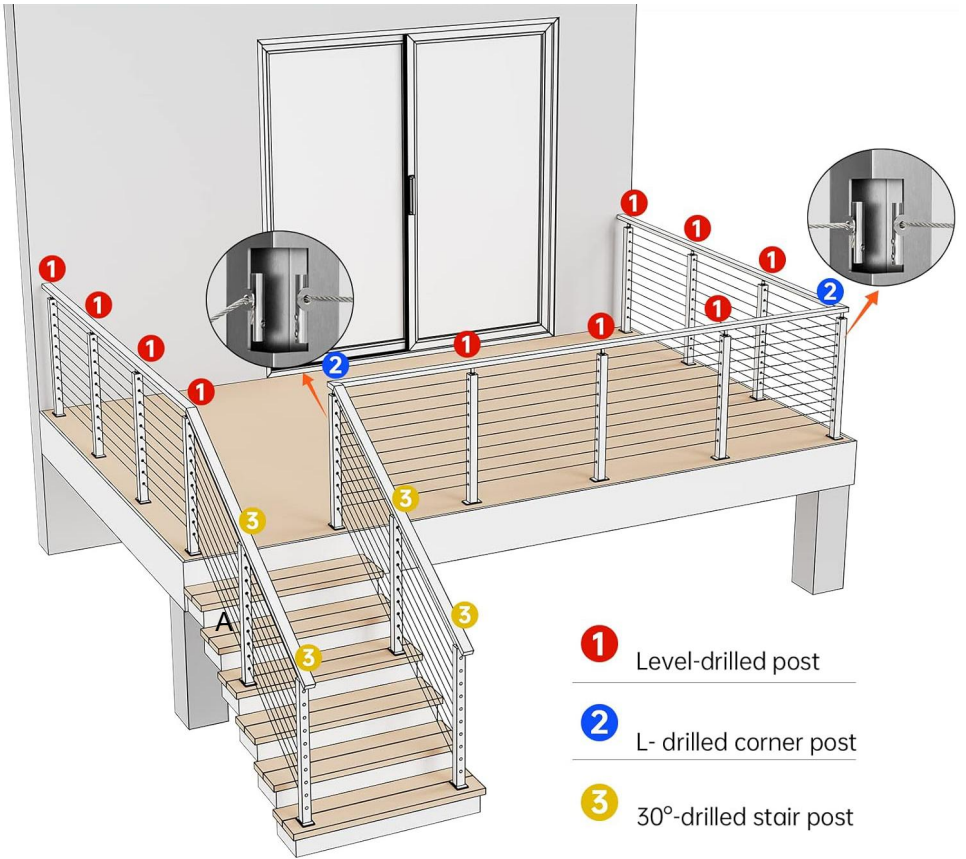

- 1** Level-drilled post
- 2** L- drilled corner post
- 3** 30°-drilled stair post

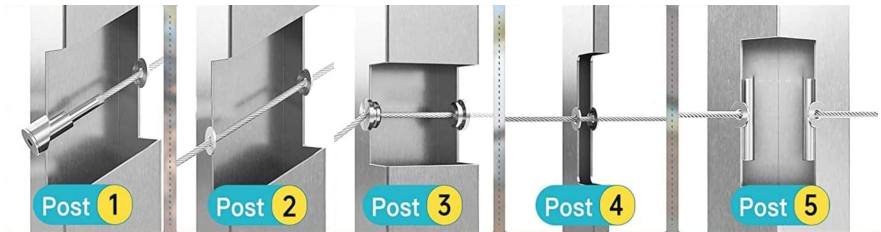

## PRODUCT INFORMATION

Model	Drilled	Height (mm)	Drilled number	Hole diameter (mm)	Pitch of holes (mm)	Section size (mm)	Color	Include (pcs)
-------	---------	-------------	----------------	--------------------	---------------------	-------------------	-------	---------------

<b>HR-001</b>	level	1067	12	φ10.5	80	50*50	Black	4
<b>HR-002</b>	level	914	10	φ10.5	80	50*50	Black	4
<b>HR-003</b>	level	1067	12	φ8	80	30*50	Black	4
<b>HR-004</b>	level	914	10	φ8	80	30*50	Black	4
<b>HR-005</b>	30°	1067	12	10.5×15	80	50*50	Silver	1
<b>HR-006</b>	30°	1067	12	10.5×15	80	50*50	Black	1
<b>HR-007</b>	L	1067	12	φ10.5	80	50*50	Black	1
<b>HR-008</b>	Non	914	/	/	/	50*50	Black	1
<b>HR-009</b>	level	914	10	φ10.5	80	50*50	Black	1
<b>HR-010</b>	30°	914	10	10.5×15	80	50*50	Black	1
<b>HR-011</b>	L	914	10	φ10.5	80	50*50	Black	1
<b>HR-012</b>	level	914	10	φ10.5	80	50*50	Silver	1
<b>HR-013</b>	30°	1067	12	8×13	80	30*50	Black	1
<b>HR-014</b>	L	1067	12	φ8	80	30*50	Black	1
<b>HR-015</b>	30°	914	10	8×13	80	30*50	Black	1
<b>HR-016</b>	L	914	10	φ8	80	30*50	Black	1

HR-017	Non	914	/	/	/	38*38	Black	1
HR-018	level	1067	12	φ8	80	30*50	Black	1
HR-019	Non	1067	/	/	/	50*50	Black	1
HR-020	level	914	10	φ8	80	30*50	Black	1
HR-021	level	1067	12	φ10.5	80	50*50	Black	1
HR-022	level	914	10	Φ8	80	30*50	Silver	1
HR-023	level	1067	12	φ10.5	80	50*50	Silver	1

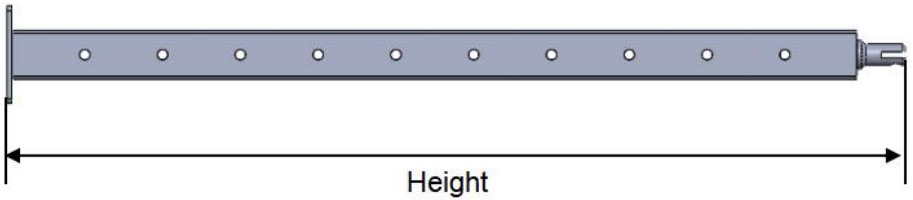

## PACKAGE INCLUDE



No	Components	Picture	QTY				
			Fit model				
			HR-001/ HR-002	HR005~HR012/ HR-019/H R-021/HR-023/	HR-003/ HR-004	HR-013~ HR-016/ HR-018/ HR-020/ HR-022/	HR-017
1	post		4	1	4	1	/
			/	/	/	/	1
2	Square cover		4	1	/	/	/

3	Rectangular cover		/	/	4	1	/
4	anchor bolt		16	4	16	4	4
5	Curved bracket		4	1	4	1	/
6	Horizontal bracket		4	1	4	1	/
7	hex wrench		4	1	4	1	1
8	Open end wrench		4	1	4	1	1
9	Tapping screw		8	2	8	2	4
10	Plastic cover		/	/	/	/	1

## INSTALLATION

### For concrete or wood floor

		
Step1.Mark the drilling points at the appropriate installation locations.	Step2.use a hammer drill to make a hole for $\varnothing$ 12 at the marked points.	Step3.Hammer the anchor screw into the drilled hole.

	
<p>Step4.Tighten the screws</p>	<p>Step5.Close the lid and finish fixing the post.</p>

**Note:** Ensure that the column is upright when fixing the bottom plate of the post.

### Mount with handrail(horizontal)

Step1: Fixed bracket

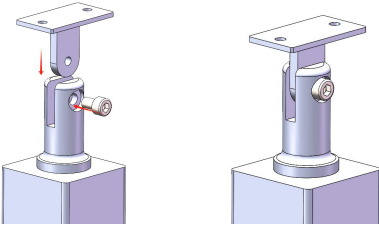

Step2: Determine the installation position of the handrail, and then mark the position under the handrail and bracket holes and drill holes with a  $\varnothing 5.5$ - $\varnothing 5.6$ mm drill.



Step3: Use the self-tapping screws in the accessory to fix the handrail to the support.



It is also suitable for the installation of arc handrails and brackets.

## Mount with handrail(gradient)

Step1: Fixed bracket

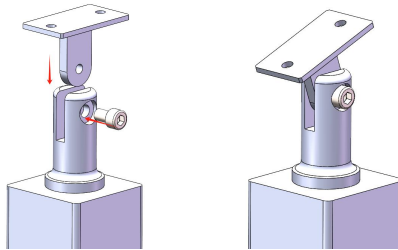

Step2: Adjust the Angle of the bracket to fit the underside of the handrail. Determine the installation position of the handrail, and then mark the position under the handrail and bracket holes and drill holes with a  $\varnothing$  5.5- $\varnothing$  5.6mm drill.

**Note:**The handrail and bracket can be pre-fixed with the help of clamping tools, so that multiple bracket installation points can be marked and positioned at the same time.



Step3:Remove the bracket from the post and then use the self-tapping screws in the accessory to fix the bracket to the handrail.  
Fix the post and bracket again.

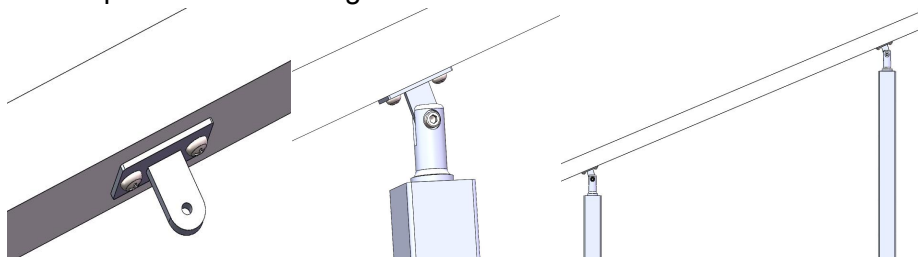

It is also suitable for the installation of arc handrails and brackets.

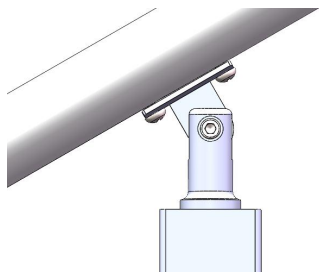

For model HR-017

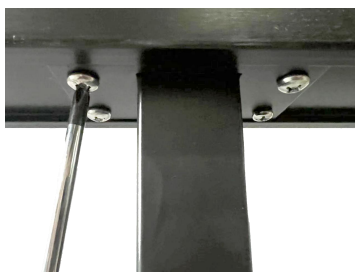

### Install with wire rope and fittings

For Level Wheel Protector Sleeve

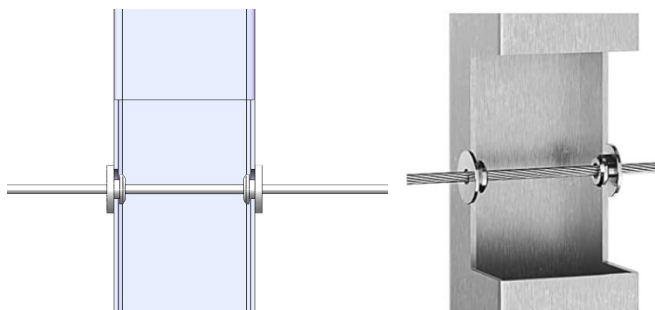

For Stud Tensioner Horizontal mounting and Angle

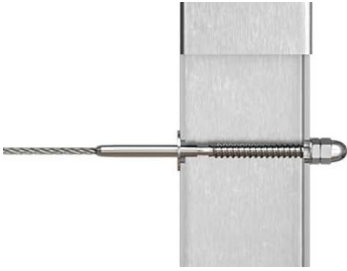

For Turnbuckle Tensioner and Fixed Terminal

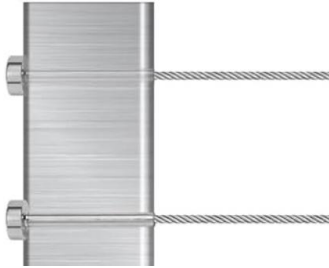

**Address:** Baoshanqu Shuangchenglu 803long 11hao 1602A-1609shi  
Shanghai

**Imported to AUS:** SIHAO PTY LTD, 1 ROKEVA STREETEASTWOOD  
NSW 2122 Australia

**Imported to USA:** Sanven Technology Ltd. Suite 250, 9166 Anaheim  
Place, Rancho Cucamonga, CA 91730



Pooledas Group Ltd  
Unit 5 Albert Edward House, The Pavilions  
Preston, United Kingdom



SHUNSHUN GmbH  
Römeräcker 9 Z2021, 76351  
Linkenheim-Hochstetten, Germany

**Made In China**

**VEVOR**<sup>®</sup>

**TOUGH TOOLS, HALF PRICE**

**Technical Support and E-Warranty Certificate**

**[www.vevor.com/support](http://www.vevor.com/support)**

# **VEVOR<sup>®</sup>**

## **TOUGH TOOLS, HALF PRICE**

Technique Assistance et certificat de garantie électronique

[www.vevor.com/support](http://www.vevor.com/support)

## **POTEAU DE GARDE-CORPS À CÂBLE**

**MODÈLE : HR-001/HR-002/HR-003/HR-004/HR-005/HR-006/HR-007/  
HR-008/HR-009/HR-010/HR-011/HR-012/HR-013/HR-014  
HR-015/HR-016/HR-017/HR-018/HR-019/HR-020/HR-021/  
HR-022/HR-023**

We continue to be committed to provide you tools with competitive price.

"Save Half", "Half Price" or any other similar expressions used by us only represents an estimate of savings you might benefit from buying certain tools with us compared to the major top brands and does not necessarily mean to cover all categories of tools offered by us. You are kindly reminded to verify carefully when you are placing an order with us if you are actually saving half in comparison with the top major brands.

# VEVOR®

TOUGH TOOLS, HALF PRICE

## CABLE RAILING POST

MODÈLE : HR-001/HR-002/HR-003/HR-004/HR-005/HR-006/HR-007/  
HR-008/HR-009/HR-010/HR-011/HR-012/HR-013/HR-014  
HR-015/HR-016/HR-017/HR-018/HR-019/HR-020/HR-021/  
HR-022/HR-023



< Image uniquement pour référence > \_

### NEED HELP? CONTACT US!

Have product questions? Need technical support? Please feel free to contact us:

**Technical Support and E-Warranty Certificate**  
[www.vevor.com/support](http://www.vevor.com/support)

This is the original instruction, please read all manual instructions carefully before operating. VEVOR reserves a clear interpretation of our user manual. The appearance of the product shall be subject to the product you received. Please forgive us that we won't inform you again if there are any technology or software updates on our product.

# GARANTIES IMPORTANTES



**AVERTISSEMENT** : Lisez et comprenez l'intégralité de ce manuel avant d'utiliser ou d'entretenir ce produit. Le non-respect de ces avertissements et instructions peut entraîner des blessures corporelles ou des dommages à des

biens de valeur.

1. L'avertissement indique que des mesures appropriées doivent être prises pour éviter tout risque potentiel de blessure.
2. Les capacités du produit s'appliquent uniquement au produit correctement et complètement assemblé.
3. Veuillez garder les petites pièces de rechange hors de portée des enfants , ce n'est pas un jouet, ne laissez pas les enfants jouer .
- 4 . Pour plus d'informations concernant les pièces répertoriées dans les pages suivantes, veuillez vous référer au schéma d'assemblage de ce manuel. Déballez et séparez toutes les pièces dans une zone de travail propre.

## CONSERVEZ CES INSTRUCTIONS

## CARACTÉRISTIQUES PRINCIPALES

Ce produit est principalement utilisé pour l'installation sur colonne de fonctions filaires et d'accessoires décoratifs .

Le poteau de garde-corps à câble de VEVOR est fabriqué à partir de tous les matériaux en acier inoxydable, qui présentent une grande résistance à la rouille et à la corrosion. Il fonctionnera pendant une longue durée de vie pour les garde-corps intérieurs et extérieurs nécessitant peu d'entretien.

Veuillez noter qu'il n'est pas recommandé pour les projets côtiers.

Nous travaillons avec tous les efforts pour fournir des produits de qualité et un service professionnel, et faire de VEVOR une marque fiable.

## INSTRUCTIONS D'INSTALLATION

### Indication d'installation et poste applicable

Applicable à tous les scénarios d' installation technique .

**Remarque :** ce produit comprend uniquement la colonne et ses attaches d'installation, à l'exclusion du câble métallique, du kit de garde-corps et de la main courante.

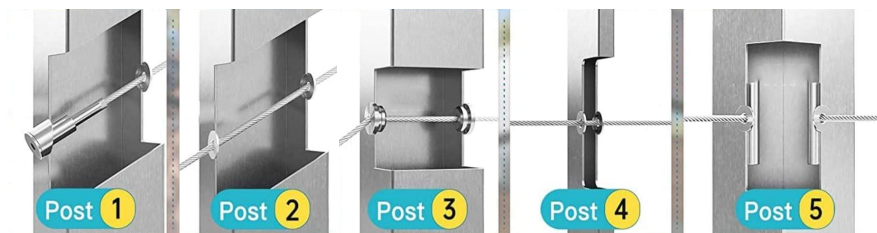
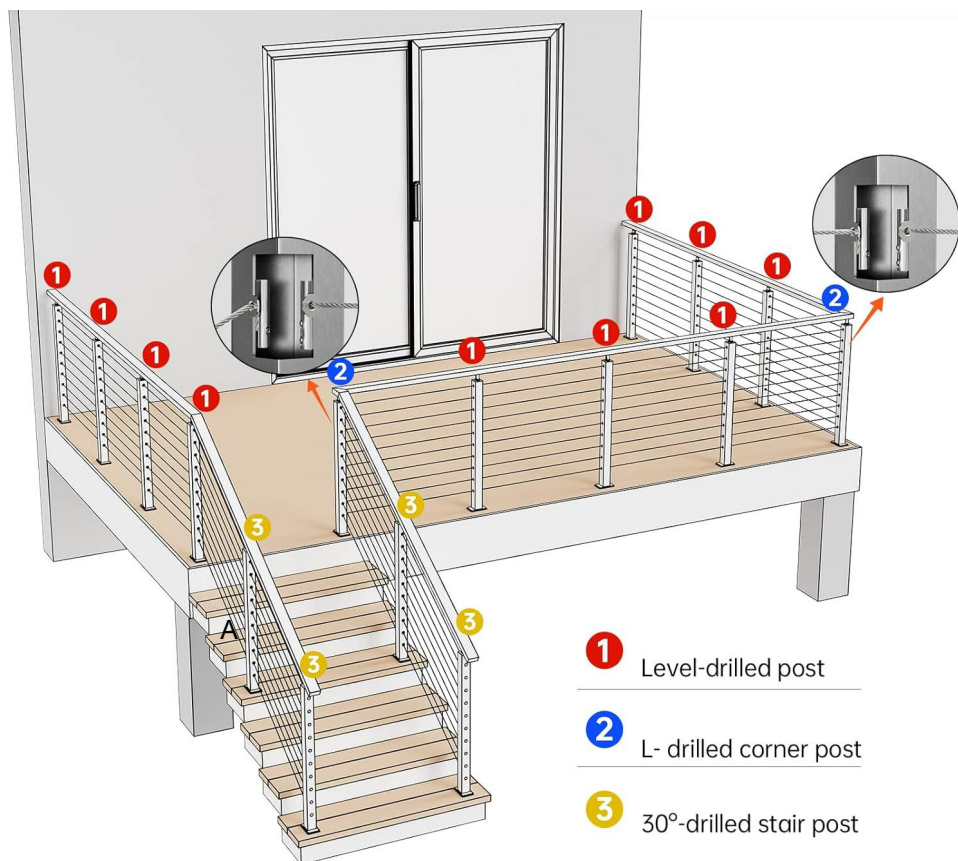

## INFORMATION PRODUIT





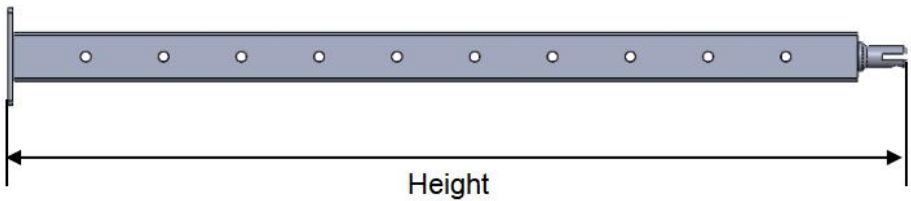



Modèle	Foré	Haut eur (mm)	Num éro percé	Diamè tre du trou (mm)	Pas des trous (mm)	Taille de section (mm)	Coul eur	Inclu re (pièc es)
HR-0 01	nive au	1067	12	φ10,5	80	50*50	Noir	4
HR-0 02	nive au	914	dix	φ10,5	80	50*50	Noir	4
HR-0 03	nive au	1067	12	φ8	80	30*50	Noir	4
HR-0 04	nive au	914	dix	φ8	80	30*50	Noir	4
HR-0 05	30°	1067	12	10,5×1 5	80	50*50	Arge nt	1
HR-0 06	30°	1067	12	10,5×1 5	80	50*50	Noir	1
HR-0 07	L	1067	12	φ10,5	80	50*50	Noir	1
HR-0 08	Non	914	/	/	/	50*50	Noir	1
HR-0 09	nive au	914	dix	φ10,5	80	50*50	Noir	1
HR-0 10	30°	914	dix	10,5×1 5	80	50*50	Noir	1
HR-0 11	L	914	dix	φ10,5	80	50*50	Noir	1
HR-0 12	nive au	914	dix	φ10,5	80	50*50	Arge nt	1
HR-0 13	30°	1067	12	8×13	80	30*50	Noir	1
HR-0 14	L	1067	12	φ8	80	30*50	Noir	1
HR-0 15	30°	914	dix	8×13	80	30*50	Noir	1

HR-0 16	L	914	dix	φ8	80	30*50	Noir	1
HR-0 17	Non	914	/	/	/	38*38	Noir	1
HR-0 18	nive au	1067	12	φ8	80	30*50	Noir	1
HR-0 19	Non	1067	/	/	/	50*50	Noir	1
HR-0 20	nive au	914	dix	φ8	80	30*50	Noir	1
HR-0 21	nive au	1067	12	φ10,5	80	50*50	Noir	1
HR-0 22	nive au	914	dix	Φ 8	80	3 0*50	Arge nt	1
HR-0 23	nive au	1067	12	φ10,5	80	50*50	Arge nt	1





## EMBALLER INCLURE



No n	Composants	Image	QTÉ				
			Modèle adapté				
			HR-001 / HR-002	HR005 ~ HR012/HR-0 19/ HR-0 21/ HR-0 23/	HR-00 3/ HR-00 4	HR-013 ~ HR-01 6/ HR-018 / HR-0 20/ HR-0 22/	HR-0 17
1	poste		4	1	4	1	/
			/	/	/	/	1

2	Couvertur e carrée		4	1	/	/	/
3	Couvertur e rectangulai re		/	/	4	1	/
4	boulon d'ancrage		16	4	16	4	4
5	Support incurvé		4	1	4	1	/
6	Support horizontal		4	1	4	1	/
7	clé hexagonal e		4	1	4	1	1
8	Clé ouverte		4	1	4	1	1
9	Taraudage		8	2	8	2	4
dix	Couvertur e plastique		/	/	/	/	1

## INSTALLATION

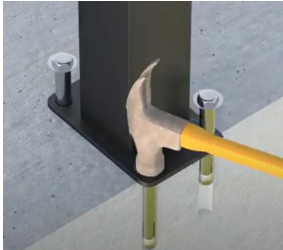
### Pour sol en béton ou en bois

		
Étape 1. Marquez les points de perçage aux	Étape 2. utilisez un marteau perforateur	Étape 3. Martelez la vis d'ancrage dans le

emplacements d'installation appropriés.	pour faire un trou de $\varnothing$ 12 aux points marqués.	trou percé.
		
Étape 4. Serrez les vis	Étape 5. Fermez le couvercle et terminez de fixer le poteau.	

**Remarque :** Assurez-vous que la colonne est verticale lors de la fixation de la plaque inférieure du poteau.

## Montage avec main courante (horizontale)

Étape 1 : support fixe

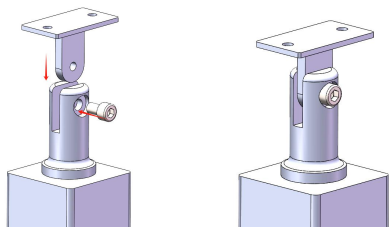

Étape 2: Déterminez la position d'installation de la main courante, puis marquez la position sous les trous de la main courante et du support et percez des trous avec une perceuse de  $\varnothing$  5,5 à  $\varnothing$  5,6 mm.



Étape 3 : Utilisez les vis autotaraudeuses fournies dans l'accessoire pour fixer la main courante au support.



Il convient également à l'installation de mains courantes et de supports en arc.

### Monter avec main courante (dégradé)

Étape 1 : support fixe

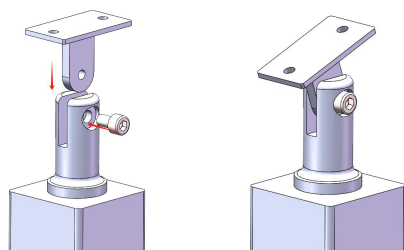

Étape 2 : Ajustez l'angle du support pour l'adapter au dessous de la main courante. Déterminez la position d'installation de la main courante, puis marquez la position sous la main courante et les trous du support et percez des trous avec une perceuse de  $\varnothing$  5,5 à  $\varnothing$  5,6 mm.

**Remarque : la main courante et le support peuvent être pré-fixés à l'aide d'outils de serrage, de sorte que plusieurs points d'installation du support puissent être marqués et positionnés en même temps.**

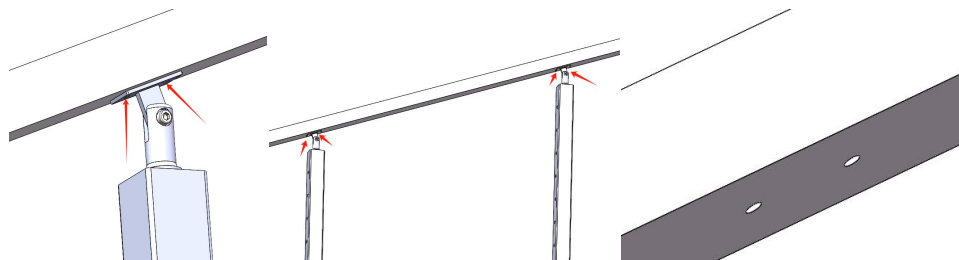

Étape 3 : retirez le support du poteau, puis utilisez les vis autotaraudeuses fournies dans l'accessoire pour fixer le support à la main courante. Réparez le poteau et le support .

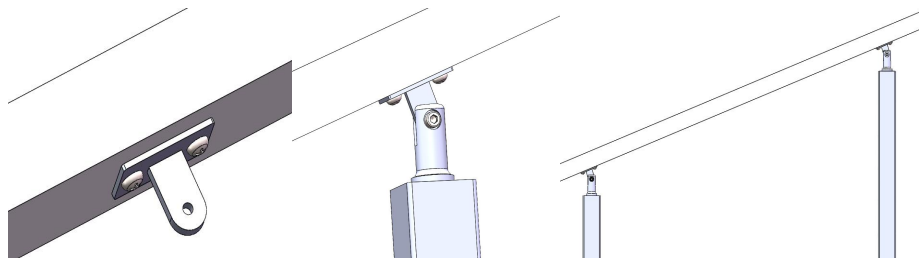

Il convient également à l'installation de mains courantes et de supports en arc.

Pour le modèle HR-017

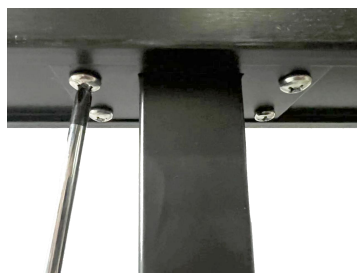
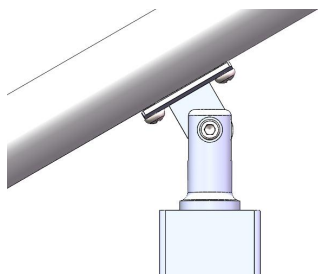

## Installer avec un câble métallique et des raccords

Pour manchon de protection de roue de niveau

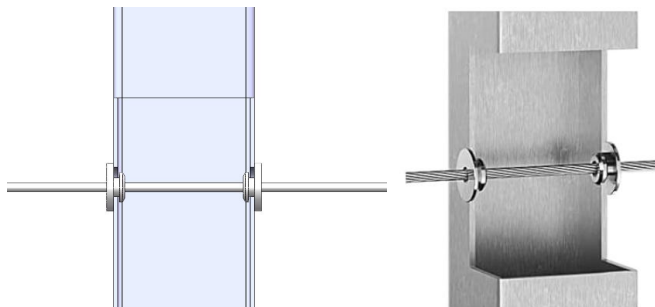

Pour tendeur de goujon montage horizontal et angle



Pour tendeur de tendeur et borne fixe

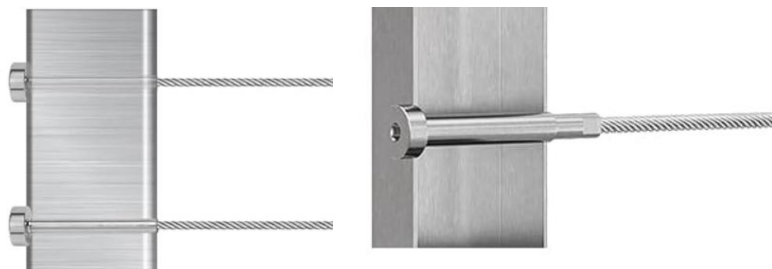

**Adresse** : Baoshanqu Shuangchenglu 803long 11hao 1602A-1609shi  
Shanghai

**Importé en Australie** : SIHAO PTY LTD, 1 ROKEVA STREETASTWOOD  
NSW 2122 Australie

**Importé aux États-Unis** : Sanven Technology Ltd. Suite 250, 9166

Anaheim Place, Rancho Cucamonga, CA 91730



Pooledas Group Ltd  
Unit 5 Albert Edward House, The Pavilions  
Preston, United Kingdom



SHUNSHUN GmbH  
Römeräcker 9 Z2021, 76351  
Linkenheim-Hochstetten, Germany

**Fabriqué en Chine**

**VEVOR<sup>®</sup>**

**TOUGH TOOLS, HALF PRICE**

**Technique Assistance et certificat de garantie électronique**

**[www.vevor.com/support](http://www.vevor.com/support)**

# **VEVOR®**

## **TOUGH TOOLS, HALF PRICE**

Technisch Support- und E-Garantie-Zertifikat [www.vevor.com/support](http://www.vevor.com/support)

### **KABELGELÄNDERPFOSTEN**

**MODELL: HR-001/HR-002/HR-003/HR-004/HR-005/HR-006/HR-007/  
HR-008/HR-009/HR-010/HR-011/HR-012/HR-013/HR-014  
HR-0 1 5 /HR-016/HR-017/HR-018/HR-019/HR-020/HR-021/  
HR-022/HR-023**

We continue to be committed to provide you tools with competitive price.

"Save Half", "Half Price" or any other similar expressions used by us only represents an estimate of savings you might benefit from buying certain tools with us compared to the major top brands and does not necessarily mean to cover all categories of tools offered by us. You are kindly reminded to verify carefully when you are placing an order with us if you are actually saving half in comparison with the top major brands.

# VEVOR®

TOUGH TOOLS, HALF PRICE

## CABLE RAILING POST

MODELL: HR-001/HR-002/HR-003/HR-004/HR-005/HR-006/HR-007/  
HR-008/HR-009/HR-010/HR-011/HR-012/HR-013/HR-014  
HR-015/HR-016/HR-017/HR-018/HR-019/HR-020/HR-021/  
HR-022/HR-023



< Bild nur als Referenz > \_

### NEED HELP? CONTACT US!

Have product questions? Need technical support? Please feel free to contact us:

**Technical Support and E-Warranty Certificate**  
[www.vevor.com/support](http://www.vevor.com/support)

This is the original instruction, please read all manual instructions carefully before operating. VEVOR reserves a clear interpretation of our user manual. The appearance of the product shall be subject to the product you received. Please forgive us that we won't inform you again if there are any technology or software updates on our product.

# WICHTIGE SICHERHEITSMASSNAHMEN



**WARNUNG** : Lesen und verstehen Sie dieses gesamte Handbuch, bevor Sie dieses Produkt in Betrieb nehmen oder warten. Die Nichtbeachtung dieser Warnungen und Anweisungen kann zu Verletzungen oder Sachschäden

führen.

1. Der Warnhinweis weist darauf hin, dass geeignete Maßnahmen ergriffen werden sollten, um die potenzielle Gefahr einer Verletzung zu vermeiden.
2. Die Produkteigenschaften gelten nur für ordnungsgemäß und vollständig montierte Produkte.
3. Bitte bewahren Sie kleine Ersatzteile außerhalb der Reichweite von Kindern auf . Es handelt sich nicht um ein Spielzeug. Lassen Sie Kinder nicht spielen .
- 4 . Weitere Informationen zu den auf den folgenden Seiten aufgeführten Teilen finden Sie im Montagediagramm dieser Anleitung. Packen Sie alle Teile aus und trennen Sie sie an einem sauberen Arbeitsplatz.

## ANLEITUNG AUFBEWAHREN

## HAUPTMERKMALE

Dieses Produkt wird hauptsächlich für die Säuleninstallation von Drahtfunktionen und dekorativem Zubehör verwendet .

Der Kabelgeländerpfosten von VEVOR ist komplett aus Edelstahl gefertigt und weist eine hohe Beständigkeit gegen Rost und Korrosion auf. Es eignet sich für eine lange Lebensdauer von Innen- und Außengeländern bei geringem Wartungsaufwand. Bitte beachten Sie , dass dies nicht für Küstenprojekte empfohlen wird.

Wir arbeiten mit aller Kraft daran, Qualitätsprodukte und professionellen Service anzubieten und VEVOR zu einer zuverlässigen Marke zu machen.

## INSTALLATIONSANWEISUNG

### Installationshinweis und anwendbarer Beitrag

Anwendbar auf alle technischen Installationsszenarien .

**Hinweis:** Dieses Produkt enthält nur die Säule und ihre Montagebefestigungen, ausgenommen Drahtseil, Kabelgeländer-Kit und Handlauf.

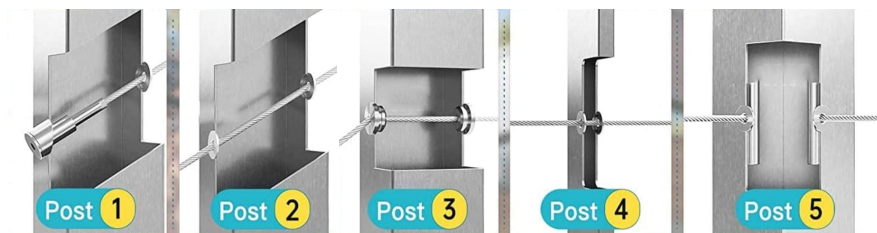
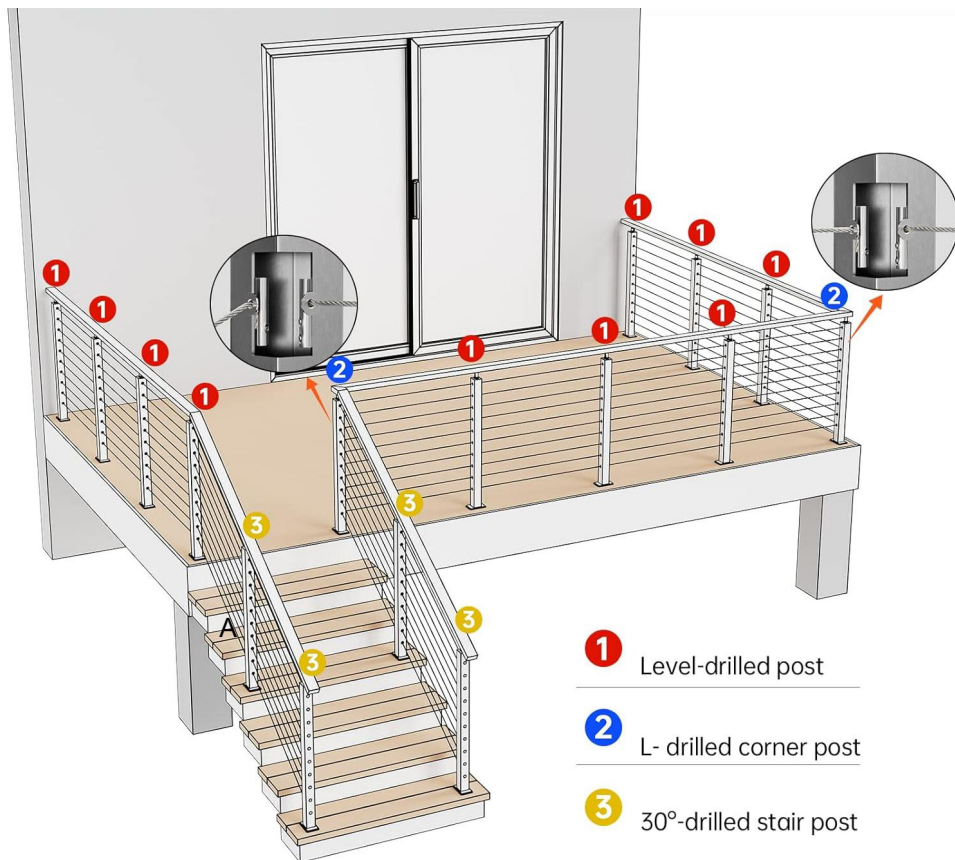



## PRODUKTINFORMATION



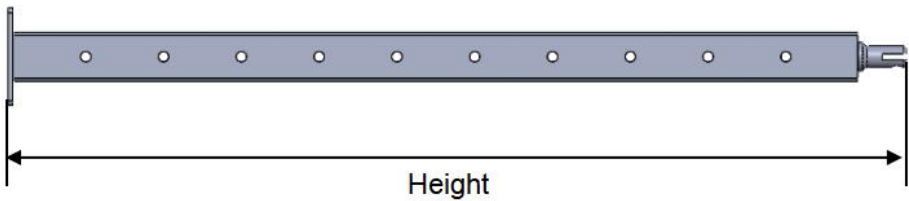





Model l	Geb ohrt	Höhe (mm)	Gebo hrte Nummer	Lochd urchmesser (mm)	Locha bstand (mm)	Abschn ittsgröß e (mm)	Farb e	Einschlie ßen (Stk.)
HR-0 01	Ebe ne	1067	12	φ10,5	80	50*50	Schw arz	4
HR-0 02	Ebe ne	914	10	φ10,5	80	50*50	Schw arz	4
HR-0 03	Ebe ne	1067	12	φ8	80	30*50	Schw arz	4
HR-0 04	Ebe ne	914	10	φ8	80	30*50	Schw arz	4
HR-0 05	30°	1067	12	10,5×1 5	80	50*50	Silbe r	1
HR-0 06	30°	1067	12	10,5×1 5	80	50*50	Schw arz	1
HR-0 07	L	1067	12	φ10,5	80	50*50	Schw arz	1
HR-0 08	Nicht	914	/	/	/	50*50	Schw arz	1
HR-0 09	Ebe ne	914	10	φ10,5	80	50*50	Schw arz	1
HR-0 10	30°	914	10	10,5×1 5	80	50*50	Schw arz	1
HR-0 11	L	914	10	φ10,5	80	50*50	Schw arz	1
HR-0 12	Ebe ne	914	10	φ10,5	80	50*50	Silbe r	1
HR-0 13	30°	1067	12	8×13	80	30*50	Schw arz	1
HR-0 14	L	1067	12	φ8	80	30*50	Schw arz	1
HR-0 15	30°	914	10	8×13	80	30*50	Schw arz	1

HR-016	L	914	10	φ8	80	30*50	Schwarz	1
HR-017	Nicht	914	/	/	/	38*38	Schwarz	1
HR-018	Ebene	1067	12	φ8	80	30*50	Schwarz	1
HR-019	Nicht	1067	/	/	/	50*50	Schwarz	1
HR-020	Ebene	914	10	φ8	80	30*50	Schwarz	1
HR-021	Ebene	1067	12	φ10,5	80	50*50	Schwarz	1
HR-022	Ebene	914	10	Φ 8	80	30*50	Silber	1
HR-023	Ebene	1067	12	φ10,5	80	50*50	Silber	1



## PAKET ENTHALTEN

NEI N	Komponenten	Bild	MENGE				
			Passendes Modell				
			HR-001 / HR-002	HR005~HR012/ HR-019/ HR-021/ HR-023/	HR-003/ HR-004	HR-013 ~ HR-016/ HR-018 / HR-020/ HR-022/	HR-017
1	Post		4	1	4	1	/
			/	/	/	/	1

2	Quadratische Abdeckung		4	1	/	/	/
3	Rechteckige Abdeckung		/	/	4	1	/
4	Ankerbolzen		16	4	16	4	4
5	Gebogene Halterung		4	1	4	1	/
6	Horizontale Halterung		4	1	4	1	/
7	Sechskantschlüssel		4	1	4	1	1
8	Gabelschlüssel		4	1	4	1	1
9	Blechschräube		8	2	8	2	4
10	Plastikhülle		/	/	/	/	1

## INSTALLATION

### Für Beton- oder Holzböden



<p>Schritt 1: Markieren Sie die Bohrpunkte an den entsprechenden Installationsorten.</p>	<p>Schritt 2: Bohren Sie mit einem Bohrhammer an den markierten Stellen ein Loch mit einem Durchmesser von <math>\varnothing</math> 12.</p>	<p>Schritt 3. Schlagen Sie die Ankerschraube in das Bohrloch.</p>
		
<p>Schritt 4. Ziehen Sie die Schrauben fest</p>	<p>Schritt 5: Schließen Sie den Deckel und schließen Sie die Befestigung des Pfostens ab.</p>	

**Hinweis:** Stellen Sie sicher, dass die Säule aufrecht steht, wenn Sie die Bodenplatte des Pfostens befestigen.

## Montage mit Handlauf (horizontal)

Schritt 1: Feste Halterung

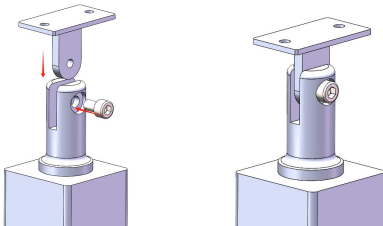

Schritt 2: Bestimmen Sie die Installationsposition des Handlaufs, markieren Sie dann die Position unter dem Handlauf und den Halterungslöchern und bohren Sie Löcher mit einem  $\varnothing$  5,5- $\varnothing$  5,6-mm-Bohrer.



Schritt 3: Befestigen Sie den Handlauf mit den selbstschneidenden Schrauben im Zubehör an der Stütze.



Es eignet sich auch für die Montage von Bogenhandläufen und Konsolen.

## Montage mit Handlauf (Gefälle)

Schritt 1: Feste Halterung

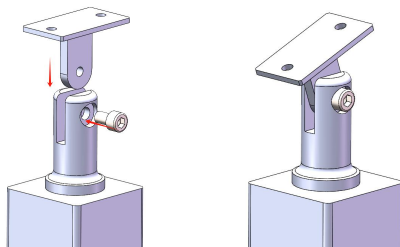

Schritt 2: Passen Sie den Winkel der Halterung an die Unterseite des Handlaufs an. Bestimmen Sie die Installationsposition des Handlaufs, markieren Sie dann die Position unter dem Handlauf und den Halterungslöchern und bohren Sie Löcher mit einem  $\varnothing$  5,5- $\varnothing$  5,6-mm-Bohrer.

**Hinweis: Der Handlauf und die Halterung können mit Hilfe von Klemmwerkzeugen vorfixiert werden, so dass mehrere**

**Montagepunkte der Halterung gleichzeitig markiert und positioniert werden können.**

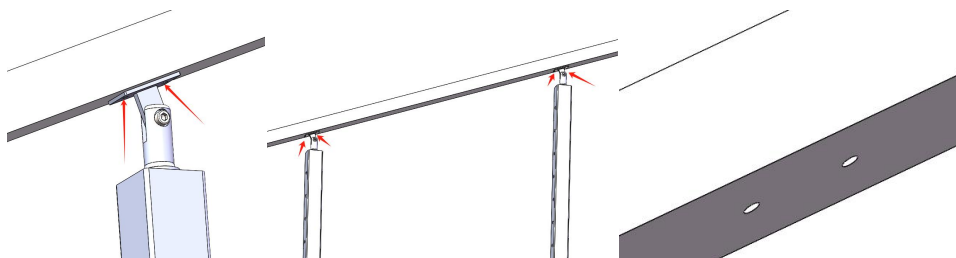

Schritt 3: Entfernen Sie die Halterung vom Pfosten und befestigen Sie die Halterung dann mit den selbstschneidenden Schrauben im Zubehör am Handlauf.

Befestigen Sie den Pfosten und die Halterung wieder .

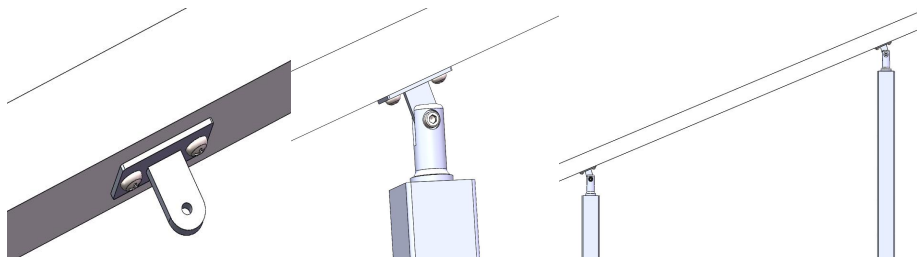

Es eignet sich auch für die Montage von Bogenhandläufen und Konsolen.

Für Modell HR-017



## Mit Drahtseil und Beschlägen installieren

Für Level-Radschutzhülle

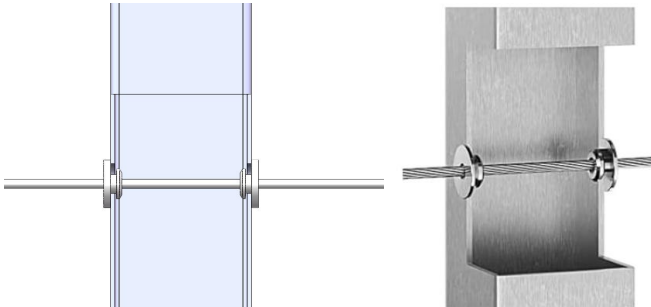

Für Bolzenspanner horizontale Montage und Winkel



Für Spansschlossspanner und Festanschluss

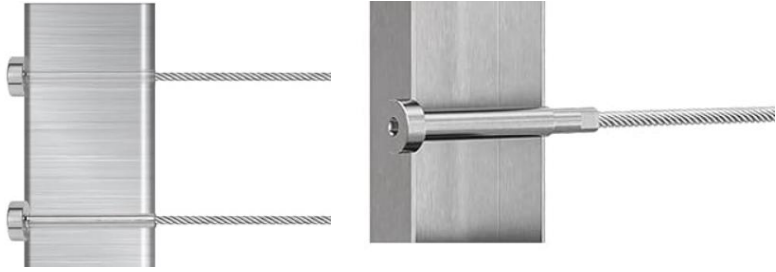

**Adresse:** Baoshanqu Shuangchenglu 803long 11hao 1602A-1609shi  
Shanghai

**Importiert nach AUS:** SIHAO PTY LTD, 1 ROKEVA STREETEASTWOOD  
NSW 2122 Australien

**In die USA importiert:** Sanven Technology Ltd. Suite 250, 9166 Anaheim  
Place, Rancho Cucamonga, CA 91730

<b>UK</b>	<b>REP</b>	Pooledas Group Ltd Unit 5 Albert Edward House, The Pavilions Preston, United Kingdom
-----------	------------	--

<b>EC</b>	<b>REP</b>	SHUNSHUN GmbH Römeräcker 9 Z2021, 76351 Linkenheim-Hochstetten, Germany
-----------	------------	---

**In China hergestellt**

**VEVOR**<sup>®</sup>

**TOUGH TOOLS, HALF PRICE**

**Technisch Support- und E-Garantiezertifikat**

**[www.vevor.com/support](http://www.vevor.com/support)**

# **VEVOR<sup>®</sup>**

## **TOUGH TOOLS, HALF PRICE**

Tecnico Supporto e certificato di garanzia elettronica [www.vevor.com/support](http://www.vevor.com/support)

### **PALO PER RINGHIERA VIA CAVO**

**MODELLO: HR-001/HR-002/HR-003/HR-004/HR-005/HR-006/HR-007/  
HR-008/HR-009/HR-010/HR-011/HR-012/HR-013/HR-014  
HR-0 1 5 /HR-016/HR-017/HR-018/HR-019/HR-020/HR-021/  
HR-022/HR-023**

We continue to be committed to provide you tools with competitive price.

"Save Half", "Half Price" or any other similar expressions used by us only represents an estimate of savings you might benefit from buying certain tools with us compared to the major top brands and does not necessarily mean to cover all categories of tools offered by us. You are kindly reminded to verify carefully when you are placing an order with us if you are actually saving half in comparison with the top major brands.

# VEVOR®

TOUGH TOOLS, HALF PRICE

## CABLE RAILING POST

MODELLO: HR-001/HR-002/HR-003/HR-004/HR-005/HR-006/HR-007/  
HR-008/HR-009/HR-010/HR-011/HR-012/HR-013/HR-014  
HR-015/HR-016/HR-017/HR-018/HR-019/HR-020/HR-021/  
HR-022/HR-023



< Immagine solo per riferimento > \_

### NEED HELP? CONTACT US!

Have product questions? Need technical support? Please feel free to contact us:

**Technical Support and E-Warranty Certificate**  
[www.vevor.com/support](http://www.vevor.com/support)

This is the original instruction, please read all manual instructions carefully before operating. VEVOR reserves a clear interpretation of our user manual. The appearance of the product shall be subject to the product you received. Please forgive us that we won't inform you again if there are any technology or software updates on our product.

## TUTELA IMPORTANTE



**AVVERTENZA** : leggere e comprendere l'intero manuale prima di utilizzare o sottoporre a manutenzione questo prodotto. La mancata osservanza di queste avvertenze e istruzioni può causare lesioni personali o danni a beni di

valore.

1. L'avvertenza indica che è necessario adottare misure adeguate per evitare il potenziale pericolo di lesioni personali.
2. Le funzionalità del prodotto si applicano solo al prodotto correttamente e completamente assemblato.
3. Si prega di tenere piccoli pezzi di ricambio fuori dalla portata dei bambini , non è un giocattolo, non permettere ai bambini di giocare .
- 4 . Per ulteriori informazioni riguardanti le parti elencate nelle pagine seguenti, fare riferimento allo Schema di Montaggio di questo manuale. Scartare e separare tutte le parti in un'area di lavoro pulita.

### **CONSERVA QUESTE ISTRUZIONI**

## **CARATTERISTICHE PRINCIPALI**

Questo prodotto viene utilizzato principalmente per l'installazione a colonna di funzioni di filo e accessori decorativi .

Il palo per ringhiera per cavi VEVOR è realizzato con tutti i materiali in acciaio inossidabile, che ha una grande resistenza alla ruggine e alla corrosione. Funzionerà per una lunga durata di ringhiere interne ed esterne con bassa manutenzione. Si tenga presente che non è consigliato per progetti costieri.

Lavoriamo con ogni sforzo per fornire prodotti di qualità e un servizio professionale e rendere VEVOR un marchio affidabile.

## **ISTRUZIONI PER L'INSTALLAZIONE**

### **Indicazione di installazione e post applicabile**

Applicabile a tutti gli scenari di installazione tecnica .

**Nota:** questo prodotto include solo la colonna e i relativi elementi di

fissaggio per l'installazione, esclusi il cavo metallico, il kit ringhiera per cavi e il corrimano.

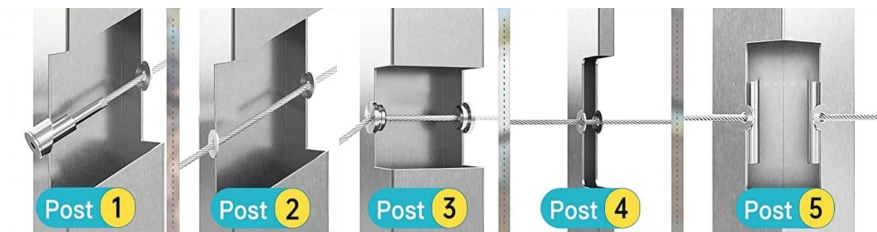
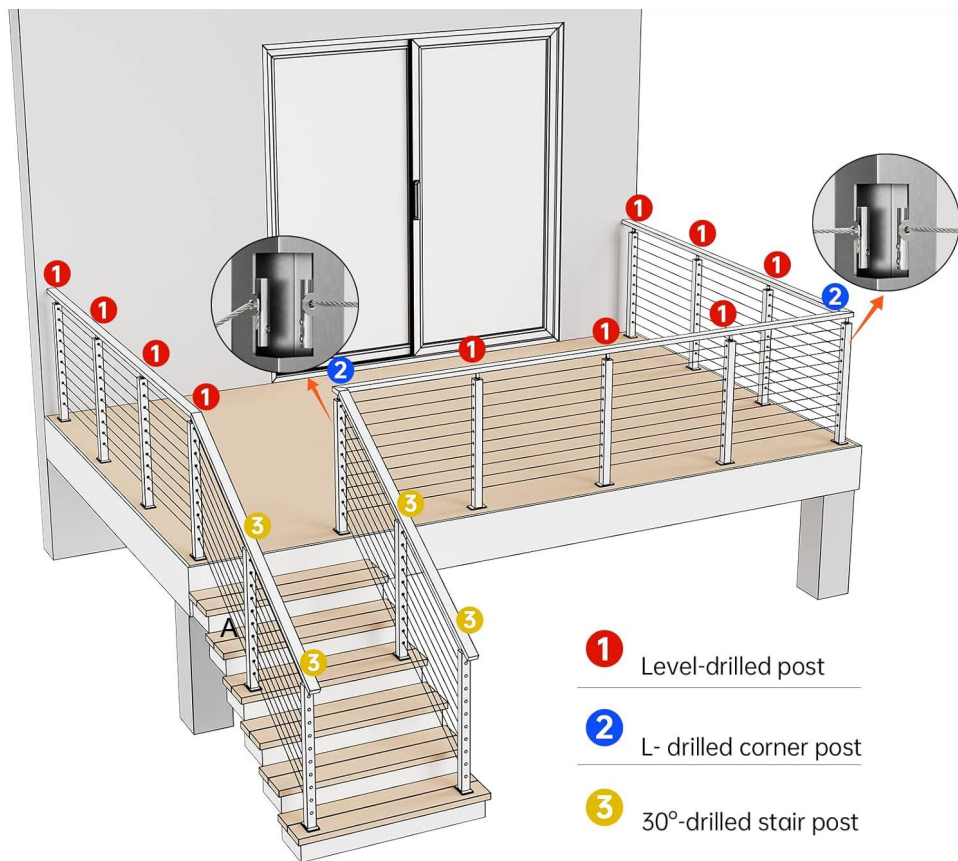

## INFORMAZIONI SUL PRODOTTO





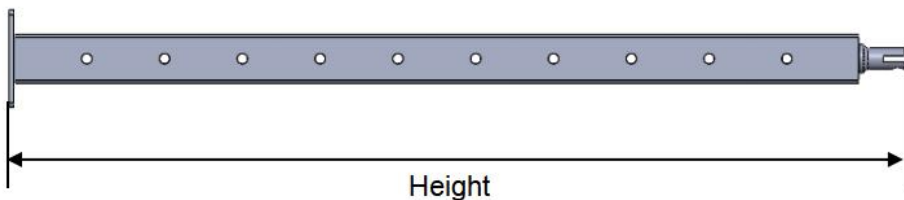



<b>Modello</b>	<b>Forato</b>	<b>Altezza (mm)</b>	<b>Numero forato</b>	<b>Diámetro del foro (mm)</b>	<b>Passo dei fori (mm)</b>	<b>Dimensione sezione (mm)</b>	<b>Color</b>	<b>Includere (pezzi)</b>
<b>HR-001</b>	livello	1067	12	φ10,5	80	50*50	Nero	4
<b>HR-002</b>	livello	914	10	φ10,5	80	50*50	Nero	4
<b>HR-003</b>	livello	1067	12	φ8	80	30*50	Nero	4
<b>HR-004</b>	livello	914	10	φ8	80	30*50	Nero	4
<b>HR-005</b>	30°	1067	12	10,5×15	80	50*50	Argento	1
<b>HR-006</b>	30°	1067	12	10,5×15	80	50*50	Nero	1
<b>HR-007</b>	I	1067	12	φ10,5	80	50*50	Nero	1
<b>HR-008</b>	Non	914	/	/	/	50*50	Nero	1
<b>HR-009</b>	livello	914	10	φ10,5	80	50*50	Nero	1
<b>HR-010</b>	30°	914	10	10,5×15	80	50*50	Nero	1
<b>HR-011</b>	I	914	10	φ10,5	80	50*50	Nero	1
<b>HR-012</b>	livello	914	10	φ10,5	80	50*50	Argento	1
<b>HR-013</b>	30°	1067	12	8×13	80	30*50	Nero	1
<b>HR-014</b>	I	1067	12	φ8	80	30*50	Nero	1
<b>HR-015</b>	30°	914	10	8×13	80	30*50	Nero	1

HR-016	I	914	10	φ8	80	30*50	Nero	1
HR-017	Non	914	/	/	/	38*38	Nero	1
HR-018	livello	1067	12	φ8	80	30*50	Nero	1
HR-019	Non	1067	/	/	/	50*50	Nero	1
HR-020	livello	914	10	φ8	80	30*50	Nero	1
HR-021	livello	1067	12	φ10,5	80	50*50	Nero	1
HR-022	livello	914	10	Φ8 _	80	30 *50	Argento	1
HR-023	livello	1067	12	φ10,5	80	50*50	Argento	1



## PACCHETTO INCLUDERE



NO	Componenti	Immagine	QUANTITÀ				
			Modello adatto				
			HR-001 / HR-002	HR005~HR012/HR-019/HR-021/HR-023/	HR-003/HR-004	HR-013 ~ HR-016/HR-018 / HR-020/HR-022/	HR-017
1	inviare		4	1	4	1	/
			/	/	/	/	1

2	Copertura quadrata		4	1	/	/	/
3	Copertura rettangolare		/	/	4	1	/
4	bullone di ancoraggio		16	4	16	4	4
5	Staffa curva		4	1	4	1	/
6	Staffa orizzontale		4	1	4	1	/
7	chiave esagonale		4	1	4	1	1
8	Chiave aperta		4	1	4	1	1
9	Vite autofilettante		8	2	8	2	4
10	Cover di plastica		/	/	/	/	1

## INSTALLAZIONE

### Per pavimenti in cemento o legno

		
Passaggio 1. Segnare i punti di foratura nelle	Passaggio 2. utilizzare un trapano a	Passaggio 3. Martellare la vite di

<p>posizioni di installazione appropriate.</p>	<p>percussione per realizzare un foro di <math>\varnothing</math> 12 nei punti contrassegnati.</p>	<p>ancoraggio nel foro praticato.</p>
		
<p>Passaggio 4. Stringere le viti</p>	<p>Passaggio 5. Chiudere il coperchio e completare il fissaggio del montante.</p>	

**Nota:** assicurarsi che la colonna sia in posizione verticale quando si fissa la piastra inferiore del montante.

## Montaggio con corrimano (orizzontale)

Passaggio 1: staffa fissa

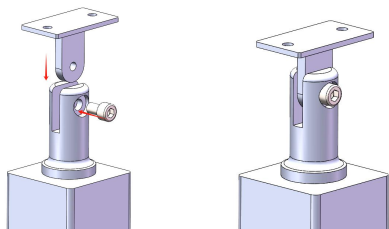

Passo 2: Determinare la posizione di installazione del corrimano, quindi segnare la posizione sotto il corrimano e i fori della staffa e praticare i fori con un trapano da  $\varnothing$  5,5- $\varnothing$  5,6 mm.



Passaggio 3: utilizzare le viti autofilettanti nell'accessorio per fissare il corrimano al supporto.



È adatto anche per l'installazione di corrimano e staffe ad arco.

## Montaggio con corrimano (gradiente)

Passaggio 1: staffa fissa

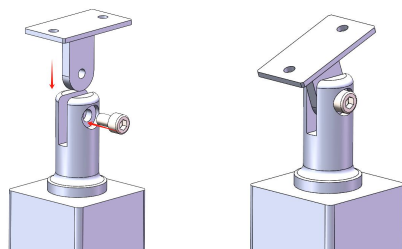

Passaggio 2: regolare l'angolo della staffa per adattarla alla parte inferiore del corrimano. Determinare la posizione di installazione del corrimano, quindi contrassegnare la posizione sotto il corrimano e i fori della staffa e praticare i fori con un trapano da  $\varnothing 5,5$ - $\varnothing 5,6$  mm.

**Nota: il corrimano e la staffa possono essere prefissati con l'aiuto di strumenti di serraggio, in modo che più punti di installazione della staffa possano essere contrassegnati e posizionati**

**contemporaneamente.**

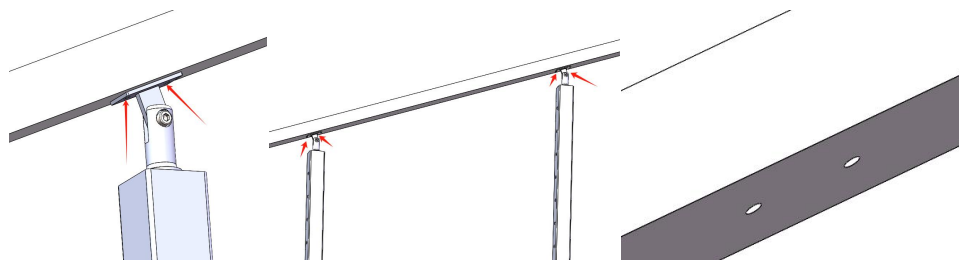

Passaggio 3: rimuovere la staffa dal montante, quindi utilizzare le viti autofilettanti nell'accessorio per fissare la staffa al corrimano. Fissare nuovamente il montante e la staffa .

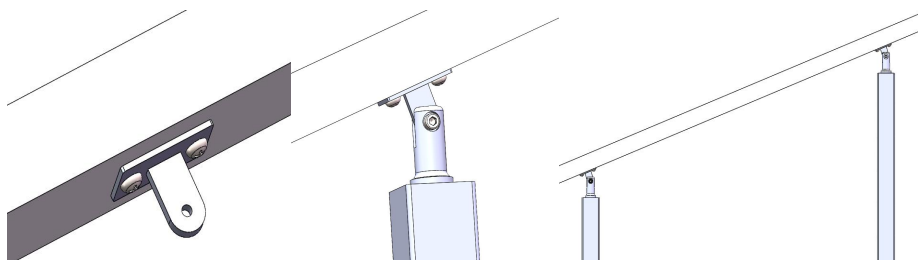

È adatto anche per l'installazione di corrimano e staffe ad arco.

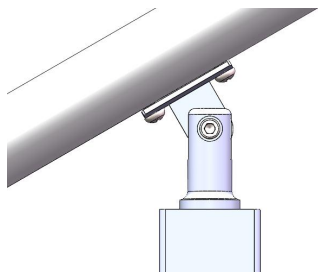

Per il modello HR-017

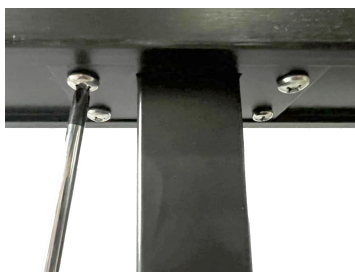

## Installare con fune metallica e raccordi

Per la manica protettiva della ruota di livello

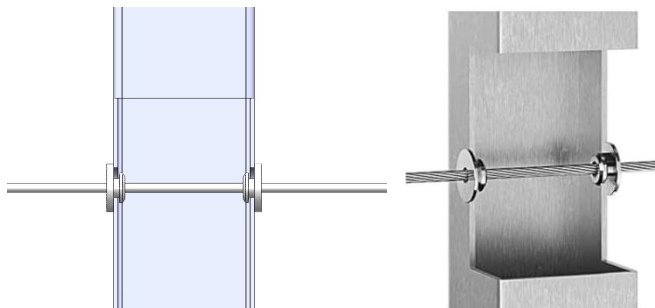

Per tensionatore a perno Montaggio orizzontale e angolare



Per tenditore a tenditore e terminale fisso

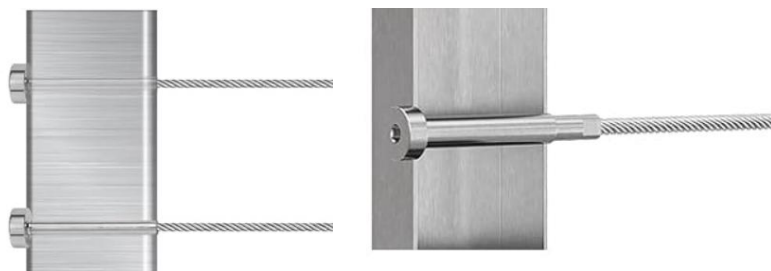

**Indirizzo:** Baoshanqu Shuangchenglu 803long 11hao 1602A-1609shi  
Shanghai

**Importato in AUS:** SIHAO PTY LTD, 1 ROKEVA STREETEASTWOOD  
NSW 2122 Australia

**Importato negli Stati Uniti:** Sanven Technology Ltd. Suite 250, 9166  
Anaheim Place, Rancho Cucamonga, CA 91730



Pooledas Group Ltd  
Unit 5 Albert Edward House, The Pavilions  
Preston, United Kingdom



SHUNSHUN GmbH  
Römeräcker 9 Z2021, 76351  
Linkenheim-Hochstetten, Germany

**Made in China**

# **VEVOR<sup>®</sup>**

**TOUGH TOOLS, HALF PRICE**

**Tecnico Supporto e certificato di garanzia elettronica**

**[www.vevor.com/support](http://www.vevor.com/support)**

# **VEVOR<sup>®</sup>**

## **TOUGH TOOLS, HALF PRICE**

Técnico Soporte y certificado de garantía electrónica [www.vevor.com/support](http://www.vevor.com/support)

## **POSTE DE BARANDILLA DE CABLE**

**MODELO: HR-001/HR-002/HR-003/HR-004/HR-005/HR-006/HR-007/  
HR-008/HR-009/HR-010/HR-011/HR-012/HR-013/HR-014  
HR-015/HR-016/HR-017/HR-018/HR-019/HR-020/HR-021/  
HR-022/HR-023**

We continue to be committed to provide you tools with competitive price.

"Save Half", "Half Price" or any other similar expressions used by us only represents an estimate of savings you might benefit from buying certain tools with us compared to the major top brands and does not necessarily mean to cover all categories of tools offered by us. You are kindly reminded to verify carefully when you are placing an order with us if you are actually saving half in comparison with the top major brands.

# VEVOR®

TOUGH TOOLS, HALF PRICE

## CABLE RAILING POST

MODELO: HR-001/HR-002/HR-003/HR-004/HR-005/HR-006/HR-007/  
HR-008/HR-009/HR-010/HR-011/HR-012/HR-013/HR-014  
HR-015/HR-016/HR-017/HR-018/HR-019/HR-020/HR-021/  
HR-022/HR-023

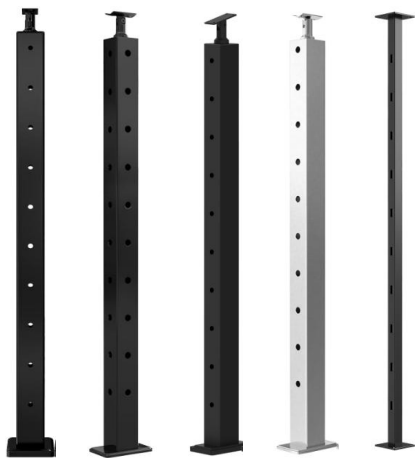

< Imagen sólo como referencia > \_

### NEED HELP? CONTACT US!

Have product questions? Need technical support? Please feel free to contact us:

**Technical Support and E-Warranty Certificate**  
[www.vevor.com/support](http://www.vevor.com/support)

This is the original instruction, please read all manual instructions carefully before operating. VEVOR reserves a clear interpretation of our user manual. The appearance of the product shall be subject to the product you received. Please forgive us that we won't inform you again if there are any technology or software updates on our product.

## CONSIDERACIONES IMPORTANTES



**ADVERTENCIA :** Lea y comprenda este manual completo antes de operar o reparar este producto. El incumplimiento de estas advertencias e instrucciones puede provocar lesiones personales o daños a bienes valiosos.

1. La advertencia indica que se deben tomar las medidas adecuadas para evitar el peligro potencial de lesiones personales.
2. Las capacidades del producto se aplican únicamente al producto ensamblado de manera adecuada y completa.
3. Mantenga las piezas de repuesto pequeñas fuera del alcance de los niños , no es un juguete, no permita que los niños jueguen .
- 4 . Para obtener información adicional sobre las piezas enumeradas en las siguientes páginas, consulte el diagrama de montaje de este manual. Desenvuelva y separe todas las piezas en un área de trabajo limpia.

### **GUARDA ESTAS INSTRUCCIONES**

## CARACTERÍSTICAS PRINCIPALES

Este producto se utiliza principalmente para la instalación en columnas de funciones de alambre y accesorios decorativos .

El poste de barandilla de cable de VEVOR está hecho completamente de materiales de acero inoxidable, lo que tiene una gran resistencia al óxido y la corrosión. Funcionará durante una larga vida útil para barandillas interiores y exteriores con bajo mantenimiento. Tenga en cuenta que no se recomienda para proyectos costeros.

Trabajamos con todo el esfuerzo para brindar productos de calidad y un servicio profesional, y hacer de VEVOR una marca confiable.

## INSTRUCCIONES DE INSTALACIÓN

### **Indicación de instalación y publicación aplicable**

Aplicable a todos los escenarios de instalación de ingeniería .

**Nota:** Este producto solo incluye la columna y sus sujetadores de instalación, excluyendo el cable metálico, el kit de barandilla de cable y el

pasamanos.

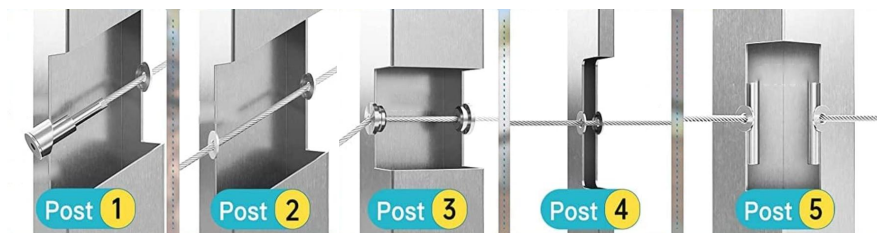
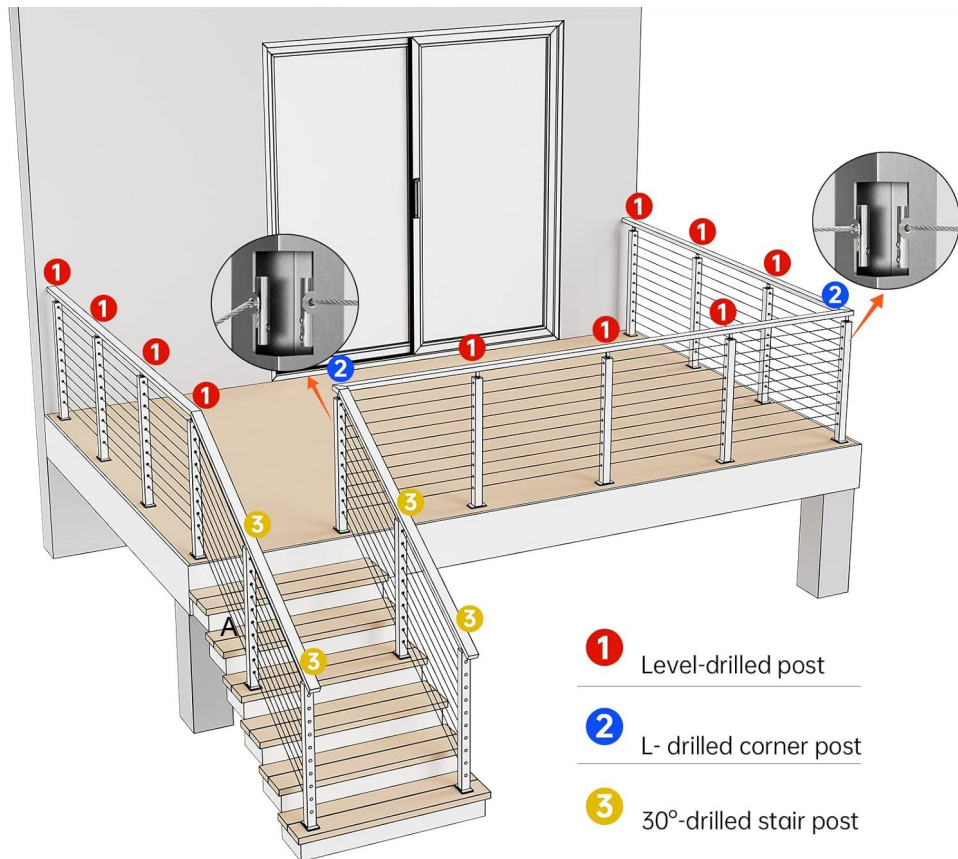



## INFORMACIÓN DEL PRODUCTO

Modelo	perforado	Altura (mm)	Número perforado	Diámetro del agujero (mm)	Paso de agujeros (mm)	Tamaño de sección (mm)	Color	Incluye (piezas)
HR-001	nivel	1067	12	φ10,5	80	50*50	Negro	4
HR-002	nivel	914	10	φ10,5	80	50*50	Negro	4
HR-003	nivel	1067	12	φ8	80	30*50	Negro	4
HR-004	nivel	914	10	φ8	80	30*50	Negro	4
HR-005	30°	1067	12	10,5×15	80	50*50	Plata	1
HR-006	30°	1067	12	10,5×15	80	50*50	Negro	1
HR-007	I	1067	12	φ10,5	80	50*50	Negro	1
HR-008	No	914	/	/	/	50*50	Negro	1
HR-009	nivel	914	10	φ10,5	80	50*50	Negro	1
HR-010	30°	914	10	10,5×15	80	50*50	Negro	1
HR-011	I	914	10	φ10,5	80	50*50	Negro	1
HR-012	nivel	914	10	φ10,5	80	50*50	Plata	1
HR-013	30°	1067	12	8×13	80	30*50	Negro	1
HR-014	I	1067	12	φ8	80	30*50	Negro	1
HR-0	30°	914	10	8×13	80	30*50	Negro	1

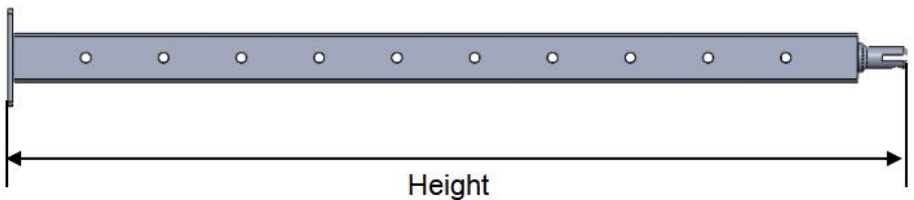
15							o	
HR-016	I	914	10	φ8	80	30*50	Negro	1
HR-017	No	914	/	/	/	38*38	Negro	1
HR-018	nivel	1067	12	φ8	80	30*50	Negro	1
HR-019	No	1067	/	/	/	50*50	Negro	1
HR-020	nivel	914	10	φ8	80	30*50	Negro	1
HR-021	nivel	1067	12	φ10,5	80	50*50	Negro	1
HR-022	nivel	914	10	Φ 8	80	3 0*50	Plata	1
HR-023	nivel	1067	12	φ10,5	80	50*50	Plata	1



## PAQUETE INCLUIR



No	Componentes	Imagen	CANTIDAD				
			Modelo de ajuste				
			HR-001 / HR-002	HR005~HR012/HR-019/ HR-0 21/ HR-0 23/	HR-00 3/ HR-00 4	HR-013 ~ HR-01 6/ HR-018 / HR-0 20/ HR-0 22/	HR-0 17
1	correo		4	1	4	1	/
			/	/	/	/	1

2	Tapa cuadrada		4	1	/	/	/
3	Tapa rectangular		/	/	4	1	/
4	perno de anclaje		dieciséis	4	dieciséis	4	4
5	Soporte curvo		4	1	4	1	/
6	soporte horizontal		4	1	4	1	/
7	llave hexagonal		4	1	4	1	1
8	Llave de boca		4	1	4	1	1
9	Tornillo de rosca		8	2	8	2	4
10	Cubierta plástica		/	/	/	/	1

## INSTALACIÓN

### Para piso de concreto o madera

		
Paso 1. Marque los puntos de perforación en las ubicaciones de instalación	Paso 2. Utilice un taladro percutor para hacer un agujero de $\varnothing$ 12 en los puntos	Paso 3. Martilla el tornillo de anclaje en el orificio perforado.

adecuadas.	marcados.	
		
<p>Paso 4. Apriete los tornillos.</p>	<p>Paso 5. Cierra la tapa y termina de fijar el poste.</p>	

**Nota:** Asegúrese de que la columna esté en posición vertical al fijar la placa inferior del poste.

## Montaje con pasamanos (horizontal)

Paso 1: soporte fijo

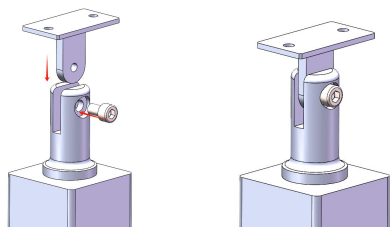

Paso 2: Determine la posición de instalación del pasamano y luego marque la posición debajo de los orificios del pasamano y del soporte y taladre los orificios con un taladro de  $\varnothing$  5,5- $\varnothing$  5,6 mm.



Paso 3: Utilice los tornillos autorroscantes del accesorio para fijar el

pasamanos al soporte.



También es adecuado para la instalación de pasamanos y soportes en arco.

## Montaje con pasamanos (gradiente)

Paso 1: soporte fijo

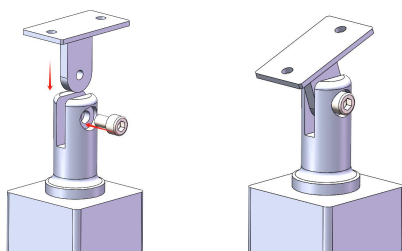

Paso 2: Ajuste el ángulo del soporte para que se ajuste a la parte inferior del pasamano. Determine la posición de instalación del pasamano y luego marque la posición debajo de los orificios del pasamano y del soporte y perforo los orificios con un taladro de  $\varnothing 5,5$ - $\varnothing 5,6$  mm.

**Nota: El pasamanos y el soporte se pueden fijar previamente con la ayuda de herramientas de sujeción, de modo que se puedan marcar y colocar múltiples puntos de instalación del soporte al mismo tiempo.**

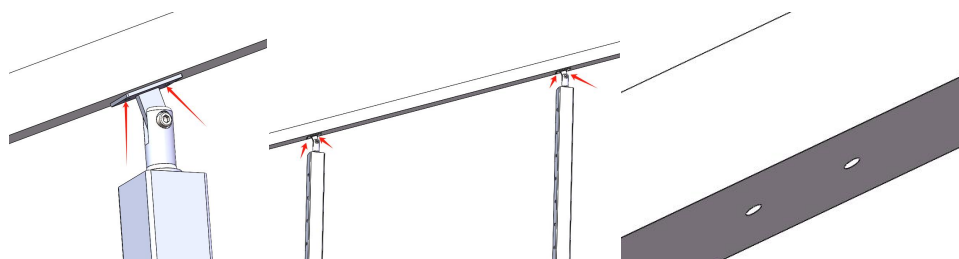

Paso 3: Retire el soporte del poste y luego use los tornillos autorroscantes del accesorio para fijar el soporte al pasamano. a fijar el poste y el soporte .

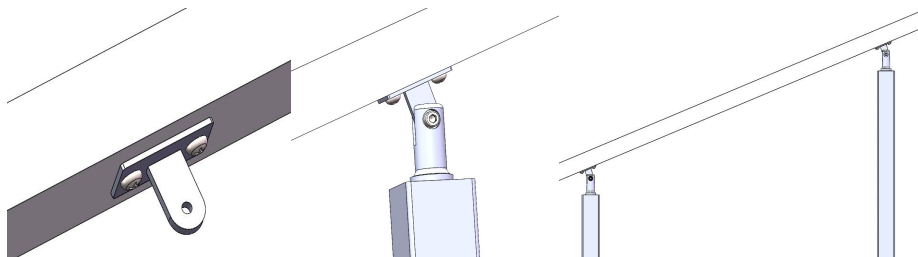

También es adecuado para la instalación de pasamanos y soportes en arco.

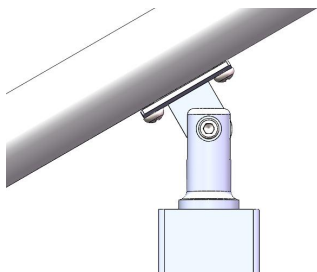

Para el modelo HR-017

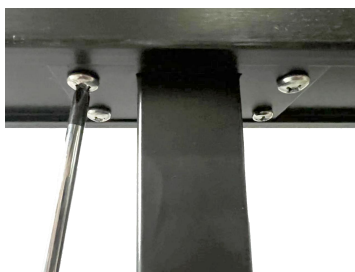

### **Instalar con cable metálico y accesorios.**

Para funda protectora de rueda nivelada

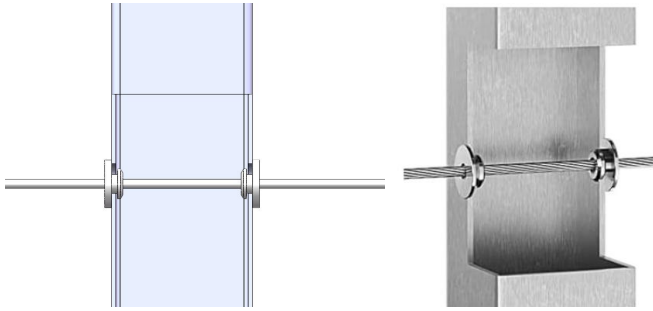

Para montaje horizontal y ángulo del tensor de pernos

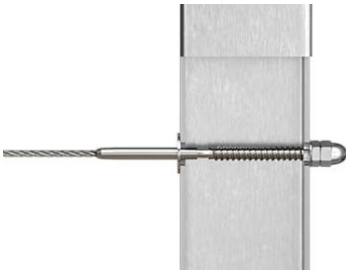

Para tensor tensor y terminal fijo



**Dirección:** Baoshanqu Shuangchenglu 803long 11hao 1602A-1609shi  
Shanghai

**Importado a AUS:** SIHAO PTY LTD, 1 ROKEVA STREETEASTWOOD  
NSW 2122 Australia

**Importado a EE. UU.:** Sanven Technology Ltd. Suite 250, 9166 Anaheim  
Place, Rancho Cucamonga, CA 91730

<b>UK</b>	<b>REP</b>
-----------	------------

Pooledas Group Ltd  
Unit 5 Albert Edward House, The Pavilions  
Preston, United Kingdom

<b>EC</b>	<b>REP</b>
-----------	------------

SHUNSHUN GmbH  
Römeräcker 9 Z2021, 76351  
Linkenheim-Hochstetten, Germany

**Hecho en china**

# **VEVOR<sup>®</sup>**

**TOUGH TOOLS, HALF PRICE**

**Técnico Certificado de soporte y garantía electrónica**

**[www.vevor.com/support](http://www.vevor.com/support)**

# **VEVOR®**

**TOUGH TOOLS, HALF PRICE**

Techniczny Certyfikat wsparcia i e-gwarancji [www.vevor.com/support](http://www.vevor.com/support)

## **SŁUPEK PORECZY KABLOWEJ**

**MODEL: HR-001/HR-002/HR-003/HR-004/HR-005/HR-006/HR-007/  
HR-008/HR-009/HR-010/HR-011/HR-012/HR-013/HR-014  
HR-0 1 5 /HR-016/HR-017/HR-018/HR-019/HR-020/HR-021/  
HR-022/HR-023**

We continue to be committed to provide you tools with competitive price.

"Save Half", "Half Price" or any other similar expressions used by us only represents an estimate of savings you might benefit from buying certain tools with us compared to the major top brands and does not necessarily mean to cover all categories of tools offered by us. You are kindly reminded to verify carefully when you are placing an order with us if you are actually saving half in comparison with the top major brands.

# VEVOR®

TOUGH TOOLS, HALF PRICE

## CABLE RAILING POST

MODEL: HR-001/HR-002/HR-003/HR-004/HR-005/HR-006/HR-007/  
HR-008/HR-009/HR-010/HR-011/HR-012/HR-013/HR-014  
HR-015/HR-016/HR-017/HR-018/HR-019/HR-020/HR-021/  
HR-022/HR-023



< Zdjęcie wyłącznie w celach informacyjnych >

### NEED HELP? CONTACT US!

Have product questions? Need technical support? Please feel free to contact us:

**Technical Support and E-Warranty Certificate**  
[www.vevor.com/support](http://www.vevor.com/support)

This is the original instruction, please read all manual instructions carefully before operating. VEVOR reserves a clear interpretation of our user manual. The appearance of the product shall be subject to the product you received. Please forgive us that we won't inform you again if there are any technology or software updates on our product.

## WAŻNI OCHRONIARZE



**OSTRZEŻENIE** : Przed przystąpieniem do obsługi lub serwisowania tego produktu należy przeczytać i zrozumieć całą niniejszą instrukcję. Niezastosowanie się do tych ostrzeżeń i instrukcji może spowodować obrażenia ciała lub

uszkodzenie cennego mienia.

1. Ostrzeżenie wskazuje, że należy podjąć odpowiednie działania, aby uniknąć potencjalnego niebezpieczeństwa obrażeń ciała.
2. Możliwości produktu dotyczą wyłącznie prawidłowo i całkowicie zmontowanego produktu.
3. Małe części zamienne należy trzymać poza zasięgiem dzieci . To nie jest zabawka. Nie pozwalaj dzieciom na zabawę .
- 4 . Dodatkowe informacje dotyczące części wymienionych na kolejnych stronach można znaleźć w schemacie montażu w niniejszej instrukcji. Rozpakuj i oddziel wszystkie części w czystym miejscu pracy.

### ZACHOWAJ TE INSTRUKCJE

## GLÓWNE CECHY

Ten produkt jest używany głównie do montażu kolumn z funkcjami drutowymi i akcesoriami dekoracyjnymi .

Słupek poręczy kablowych firmy VEVOR wykonany jest w całości ze stali nierdzewnej, która charakteryzuje się dużą odpornością na rdzę i korozję. Będzie działać przez długi czas w przypadku balustrad wewnętrznych i zewnętrznych przy niewielkich wymaganiach konserwacyjnych. Należy pamiętać , że nie jest on zalecany do projektów przybrzeżnych. Dokładamy wszelkich starań, aby zapewnić wysoką jakość produktów i profesjonalną obsługę oraz sprawić, że VEVOR będzie niezawodną marką.

## INSTRUKCJA INSTALACJI

### Wskazanie instalacji i odpowiedni słupek

Ma zastosowanie do wszystkich scenariuszy instalacji inżynierskich .

**Uwaga:** ten produkt zawiera wyłącznie kolumnę i elementy mocujące do niej, z wyłączeniem liny stalowej, zestawu poręczy kablowych i poręczy.

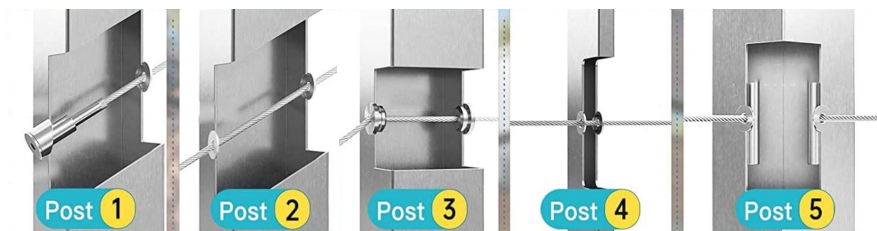
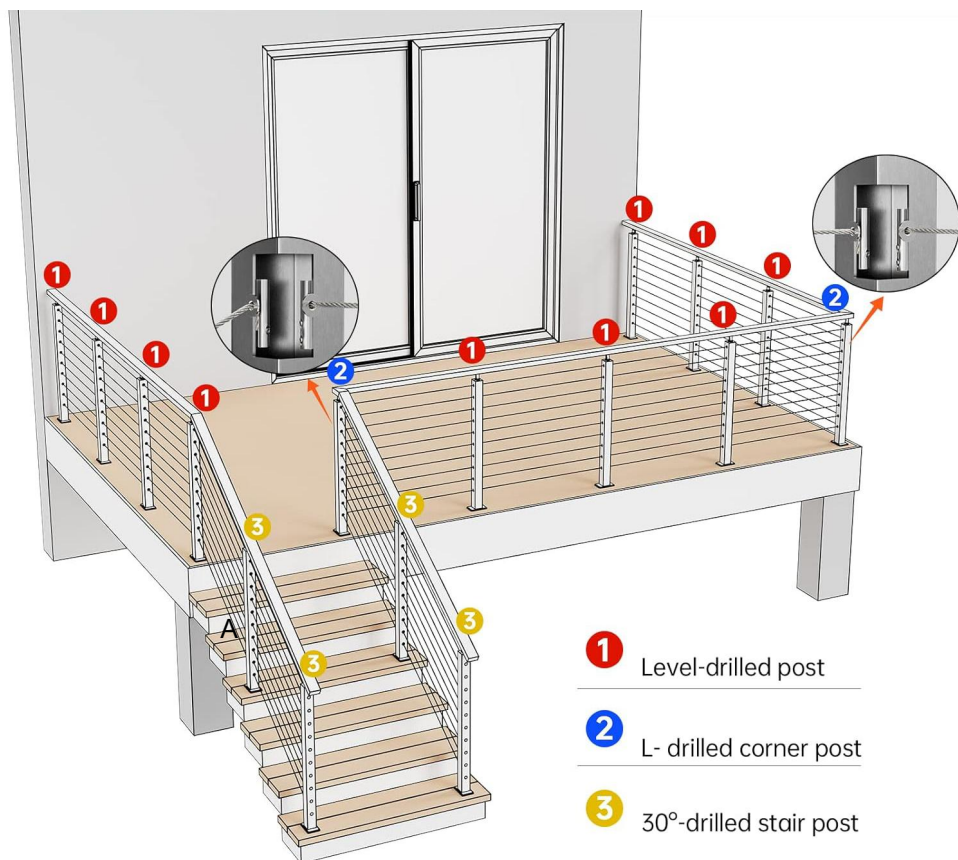

## INFORMACJE O PRODUKCIE

Model	Wiercone	Wyokość (mm)	Wywiercony numer	Średnica otworu (mm)	Rozstaw otworów (mm)	Rozmiar przekroju (mm)	Kolor	Uwzględnij (szt.)
HR-001	poziom	1067	12	φ10,5	80	50*50	Czarny	4
HR-002	poziom	914	10	φ10,5	80	50*50	Czarny	4
HR-003	poziom	1067	12	φ8	80	30*50	Czarny	4
HR-004	poziom	914	10	φ8	80	30*50	Czarny	4
HR-005	30°	1067	12	10,5×15	80	50*50	Srebro	1
HR-006	30°	1067	12	10,5×15	80	50*50	Czarny	1
HR-007	L	1067	12	φ10,5	80	50*50	Czarny	1
HR-008	Nie	914	/	/	/	50*50	Czarny	1
HR-009	poziom	914	10	φ10,5	80	50*50	Czarny	1
HR-010	30°	914	10	10,5×15	80	50*50	Czarny	1
HR-011	L	914	10	φ10,5	80	50*50	Czarny	1
HR-012	poziom	914	10	φ10,5	80	50*50	Srebro	1
HR-013	30°	1067	12	8×13	80	30*50	Czarny	1
HR-014	L	1067	12	φ8	80	30*50	Czarny	1
HR-0	30°	914	10	8×13	80	30*50	Czar	1

15							ny	
HR-016	L	914	10	$\varphi 8$	80	30*50	Czarny	1
HR-017	Nie	914	/	/	/	38*38	Czarny	1
HR-018	poziom	1067	12	$\varphi 8$	80	30*50	Czarny	1
HR-019	Nie	1067	/	/	/	50*50	Czarny	1
HR-020	poziom	914	10	$\varphi 8$	80	30*50	Czarny	1
HR-021	poziom	1067	12	$\varphi 10,5$	80	50*50	Czarny	1
HR-022	poziom	914	10	$\Phi 8$	80	30*50	Srebro	1
HR-023	poziom	1067	12	$\varphi 10,5$	80	50*50	Srebro	1

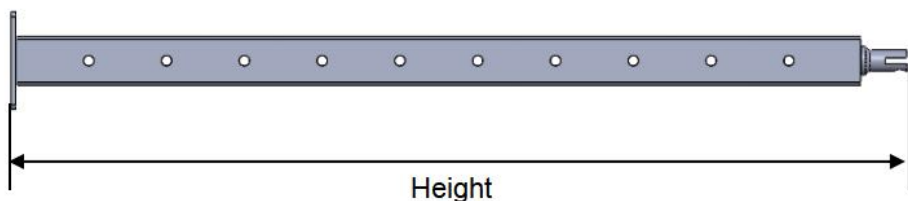

## PAKIET WŁĄCZAĆ

NIE	składniki	Zdjęcie	ILOŚĆ				
			Dopasowany model				
			HR-001 / HR-002	HR005~HR012/HR-019/ HR-0 21/ HR-0 23/	HR-00 3/ HR-00 4	HR-013 ~ HR-01 6/ HR-018 / HR-0 20/ HR-0 22/	HR-0 17
1	post		4	1	4	1	/
			/	/	/	/	1

2	Kwadrato wa osłona		4	1	/	/	/
3	Prostokąt a osłona		/	/	4	1	/
4	śruba kotwowa		16	4	16	4	4
5	Zakrzywio ny wspornik		4	1	4	1	/
6	Wspornik poziomy		4	1	4	1	/
7	klucz sześciokąt ny		4	1	4	1	1
8	Klucz płaski		4	1	4	1	1
9	Śruba gwintująca		8	2	8	2	4
10	Plastikowa obudowa		/	/	/	/	1

## INSTALACJA

### Do podłóg betonowych lub drewnianych

		
Krok 1. Zaznacz punkty wiercenia w odpowiednich	Krok 2. Za pomocą wiertarki udarowej wykonaj w	Krok 3. Wbij śrubę kotwową w wywiercony otwór.

miejscach montażu.	zaznaczonych punktach otwór o średnicy $\varnothing$ 12.	
		
Krok 4. Dokręć śruby	Krok 5. Zamknij pokrywę i dokończ mocowanie słupka.	

**Uwaga:** Podczas mocowania dolnej płyty słupka upewnij się, że kolumna jest ustawiona pionowo.

## Mocowanie z poręczą (poziomo)

Krok 1: Naprawiono wspornik

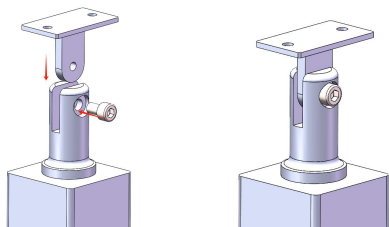

Krok 2: Określ pozycję montażową poręczy, a następnie zaznacz położenie pod poręczą i otworami wspornika i wywierć otwory wiertłem  $\varnothing$  5,5- $\varnothing$  5,6mm.



Krok 3: Użyj wkrętów samogwintujących znajdujących się w akcesorium, aby przymocować poręcz do wspornika.



Nadaje się również do montażu poręczy łukowych i wsporników.

## Montaż z poręczą (gradient)

Krok 1: Naprawiono wspornik

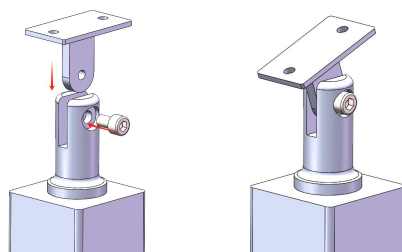

Krok 2: Dostosuj kąt wspornika, aby dopasować go do spodniej strony poręczy. Określ pozycję montażową poręczy, a następnie zaznacz pozycję pod poręczą i otworami wspornika, a następnie wywierć otwory wiertłem  $\varnothing 5,5 - \varnothing 5,6$  mm.

**Uwaga: Poręcz i wspornik można wstępnie zamocować za pomocą narzędzi zaciskowych, dzięki czemu można jednocześnie zaznaczyć i ustawić wiele punktów montażowych wspornika.**



**Krok 3: Zdejmij wspornik ze słupka, a następnie użyj wkrętów samogwintujących znajdujących się w akcesorium, aby przymocować wspornik do poręczy.**

**Zamocuj ponownie słupek i wspornik .**

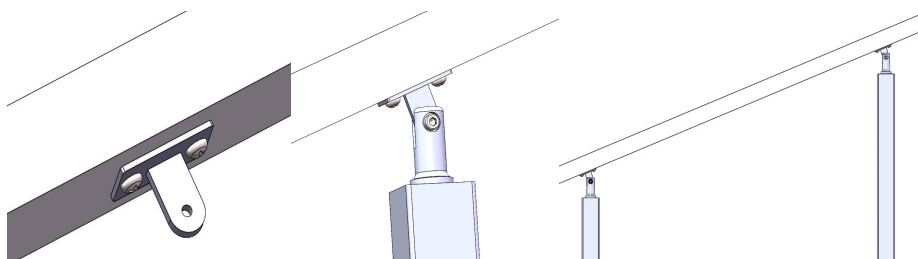

**Nadaje się również do montażu poręczy łukowych i wsporników.**

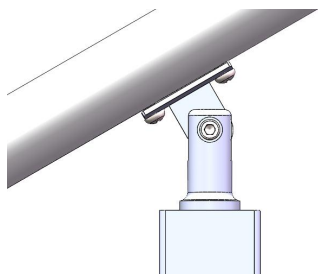

**Dla modelu HR-017**

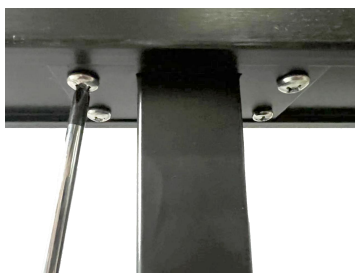

## Montaż za pomocą liny stalowej i okuć

Do tulei zabezpieczającej koło poziome

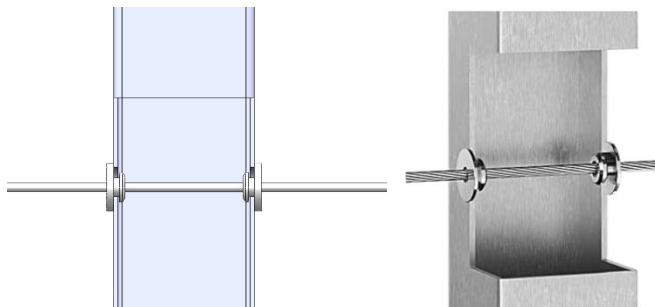

Do napinacza dwustronnego, montaż poziomy i kątowy



Do napinacza śruby rzymskiej i zacisku stałego

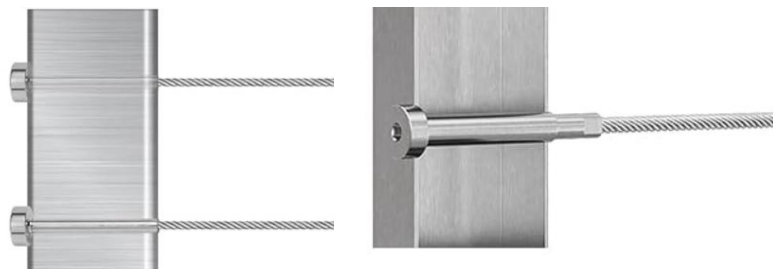

**Adres:** Baoshanqu Shuangchenglu 803long 11hao 1602A-1609shi  
Szanghaj

**Import do AUS:** SIHAO PTY LTD, 1 ROKEVA STREET EASTWOOD NSW  
2122 Australia

**Import do USA:** Sanven Technology Ltd. Suite 250, 9166 Anaheim Place,

Rancho Cucamonga, CA 91730



Pooledas Group Ltd  
Unit 5 Albert Edward House, The Pavilions  
Preston, United Kingdom



SHUNSHUN GmbH  
Römeräcker 9 Z2021, 76351  
Linkenheim-Hochstetten, Germany

**Wyprodukowano w Chinach**

# **VEVOR<sup>®</sup>**

**TOUGH TOOLS, HALF PRICE**

**Techniczny Certyfikat wsparcia i e-gwarancji**

**[www.vevor.com/support](http://www.vevor.com/support)**

# **VEVOR<sup>®</sup>**

## **TOUGH TOOLS, HALF PRICE**

Technisch Ondersteuning en e-garantiecertificaat [www.vevor.com/support](http://www.vevor.com/support)

## **KABELRAILINGPAAL**

**MODELLEN: HR-001/HR-002/HR-003/HR-004/HR-005/HR-006/HR-007/  
HR-008/HR-009/HR-010/HR-011/HR-012/HR-013/HR-014  
HR-0 1 5 /HR-016/HR-017/HR-018/HR-019/HR-020/HR-021/  
HR-022/HR-023**

We continue to be committed to provide you tools with competitive price.

"Save Half", "Half Price" or any other similar expressions used by us only represents an estimate of savings you might benefit from buying certain tools with us compared to the major top brands and does not necessarily mean to cover all categories of tools offered by us. You are kindly reminded to verify carefully when you are placing an order with us if you are actually saving half in comparison with the top major brands.

# VEVOR®

TOUGH TOOLS, HALF PRICE

## CABLE RAILING POST

MODELLEN: HR-001/HR-002/HR-003/HR-004/HR-005/HR-006/HR-007/  
HR-008/HR-009/HR-010/HR-011/HR-012/HR-013/HR-014  
HR-015/HR-016/HR-017/HR-018/HR-019/HR-020/HR-021/  
HR-022/HR-023



< Afbeelding alleen ter referentie > \_

### NEED HELP? CONTACT US!

Have product questions? Need technical support? Please feel free to contact us:

**Technical Support and E-Warranty Certificate**  
[www.vevor.com/support](http://www.vevor.com/support)

This is the original instruction, please read all manual instructions carefully before operating. VEVOR reserves a clear interpretation of our user manual. The appearance of the product shall be subject to the product you received. Please forgive us that we won't inform you again if there are any technology or software updates on our product.

# BELANGRIJKE VEILIGHEIDSMATREGELEN



**WAARSCHUWING** : Lees en begrijp deze gehele handleiding voordat u dit product bedient of onderhoudt. Het niet opvolgen van deze waarschuwingen en instructies kan persoonlijk letsel of schade aan waardevolle eigendommen veroorzaken.

1. De waarschuwing geeft aan dat passende maatregelen moeten worden genomen om het potentiële gevaar van persoonlijk letsel te voorkomen.
2. Productmogelijkheden zijn alleen van toepassing op correct en volledig gemonteerde producten.
3. Bewaar kleine reserveonderdelen buiten het bereik van kinderen . Het is geen speelgoed. Laat kinderen niet spelen .
- 4 . Voor aanvullende informatie over de onderdelen die op de volgende pagina's worden vermeld, verwijzen wij u naar het montageschema van deze handleiding. Pak alle onderdelen uit en scheid ze van elkaar op een schone werkplek.

## BEWAAR DEZE INSTRUCTIES

## BELANGRIJKSTE KENMERKEN

Dit product wordt voornamelijk gebruikt voor kolominstallatie van draadfuncties en decoratieve accessoires .

De kabelrailpaal van VEVOR is gemaakt van volledig roestvrijstalen materialen, die een grote weerstand hebben tegen roest en corrosie. Het zal een lange levensduur hebben voor binnen- en buitenleuningen met weinig onderhoud. Houd er rekening mee dat dit niet wordt aanbevolen voor kustprojecten.

We doen er alles aan om kwaliteitsproducten en professionele service te leveren, en maken van VEVOR een betrouwbaar merk.

## INSTALLATIE INSTRUCTIE

### Installatie-indicatie en toepasselijke post

Van toepassing op alle technische installatiescenario's .

**Opmerking:** Dit product bevat alleen de kolom en de

installatiebevestigingen, exclusief staalkabel, kabelrailset en leuning.

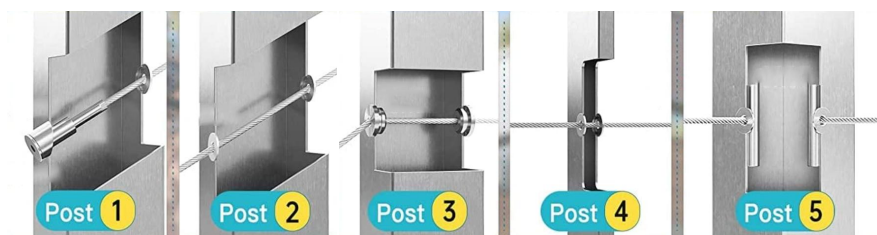
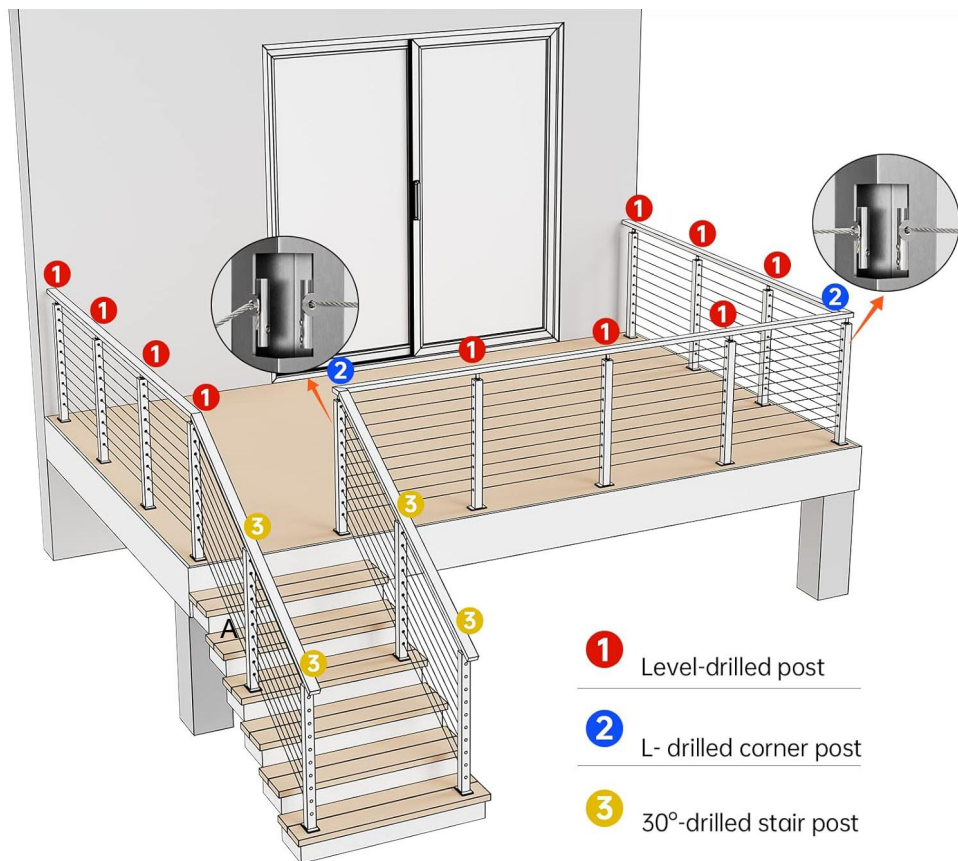



## PRODUCTINFORMATIE



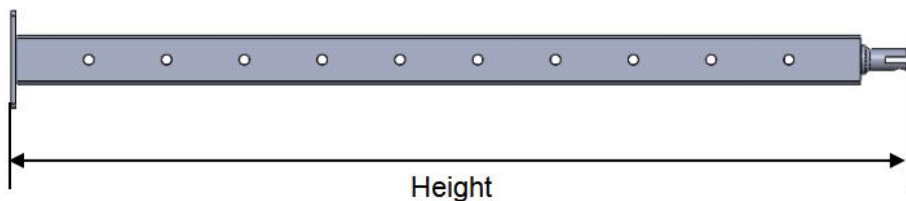





Model	Geb oord	Hoog te (mm)	Gebo ord num mer	Gatdia meter (mm)	Gaten afstan d (mm)	Sectieg rootte (mm)	Kleur	Inclu sief (stuk s)
HR-0 01	nive au	1067	12	φ10,5	80	50*50	Zwart	4
HR-0 02	nive au	914	10	φ10,5	80	50*50	Zwart	4
HR-0 03	nive au	1067	12	φ8	80	30*50	Zwart	4
HR-0 04	nive au	914	10	φ8	80	30*50	Zwart	4
HR-0 05	30°	1067	12	10,5×1 5	80	50*50	Zilver	1
HR-0 06	30°	1067	12	10,5×1 5	80	50*50	Zwart	1
HR-0 07	L	1067	12	φ10,5	80	50*50	Zwart	1
HR-0 08	Niet	914	/	/	/	50*50	Zwart	1
HR-0 09	nive au	914	10	φ10,5	80	50*50	Zwart	1
HR-0 10	30°	914	10	10,5×1 5	80	50*50	Zwart	1
HR-0 11	L	914	10	φ10,5	80	50*50	Zwart	1
HR-0 12	nive au	914	10	φ10,5	80	50*50	Zilver	1
HR-0 13	30°	1067	12	8×13	80	30*50	Zwart	1
HR-0 14	L	1067	12	φ8	80	30*50	Zwart	1
HR-0 15	30°	914	10	8×13	80	30*50	Zwart	1

HR-016	L	914	10	φ8	80	30*50	Zwart	1
HR-017	Niet	914	/	/	/	38*38	Zwart	1
HR-018	niveau	1067	12	φ8	80	30*50	Zwart	1
HR-019	Niet	1067	/	/	/	50*50	Zwart	1
HR-020	niveau	914	10	φ8	80	30*50	Zwart	1
HR-021	niveau	1067	12	φ10,5	80	50*50	Zwart	1
HR-022	niveau	914	10	Φ 8	80	30*50	Zilver	1
HR-023	niveau	1067	12	φ10,5	80	50*50	Zilver	1



## PAKKET ERBIJ BETREKKEN

Nee	Componenten	Afbeelding	AANTAL				
			Passend model				
			HR-001 / HR-002	HR005~HR012/HR-019/HR-021/HR-023/	HR-003/HR-004	HR-013 ~ HR-016/HR-018 /HR-020/HR-022/	HR-017
1	na		4	1	4	1	/
			/	/	/	/	1

2	Vierkant deksel		4	1	/	/	/
3	Rechthoekig deksel		/	/	4	1	/
4	verankering sbout		16	4	16	4	4
5	Gebogen beugel		4	1	4	1	/
6	Horizontale beugel		4	1	4	1	/
7	inbussleutel		4	1	4	1	1
8	Steeksleutel		4	1	4	1	1
9	Tapschroef		8	2	8	2	4
10	Plastic hoesje		/	/	/	/	1

## INSTALLATIE

### Voor betonnen of houten vloeren

		
<p>Stap 1. Markeer de boorpunten op de juiste installatielocaties.</p>	<p>Stap 2. Gebruik een boorhamer om op de gemarkeerde punten een gat van <math>\varnothing</math> 12 te maken.</p>	<p>Stap 3. Hamer de ankerschroef in het geboorde gat.</p>

	
<p>Stap 4. Draai de schroeven vast</p>	<p>Stap 5. Sluit het deksel en voltooi het bevestigen van de paal.</p>

**Opmerking:** Zorg ervoor dat de kolom rechtop staat wanneer u de bodemplaat van de paal bevestigt.

## Montage met leuning (horizontaal)

Stap 1: Vaste beugel

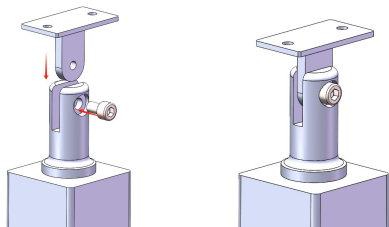

Stap 2: Bepaal de installatiepositie van de leuning, markeer vervolgens de positie onder de leuning en de beugelgaten en boor gaten met een boor van  $\varnothing$  5,5- $\varnothing$  5,6 mm.



Stap 3: Gebruik de parkers in het accessoire om de leuning aan de steun te bevestigen.



Het is ook geschikt voor de installatie van boogleuningen en beugels.

## Monteer met leuning (gradiënt)

Stap 1: Vaste beugel

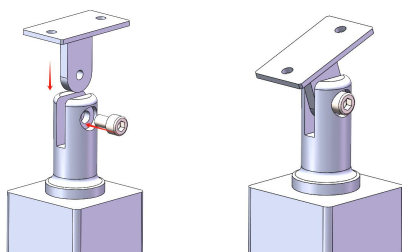

Stap 2: Pas de hoek van de beugel aan zodat deze op de onderkant van de leuning past. Bepaal de installatiepositie van de leuning en markeer vervolgens de positie onder de leuning en de beugelgaten en boor gaten met een boor van  $\varnothing 5,5$ - $\varnothing 5,6$  mm.

**Opmerking:** De leuning en beugel kunnen met behulp van klemgereedschap vooraf worden bevestigd, zodat meerdere montagepunten van de beugel tegelijkertijd kunnen worden gemarkeerd en gepositioneerd.



Stap 3: Verwijder de beugel van de paal en gebruik vervolgens de zelftappende schroeven in het accessoire om de beugel aan de leuning te bevestigen.

Bevestig de paal en beugel opnieuw .

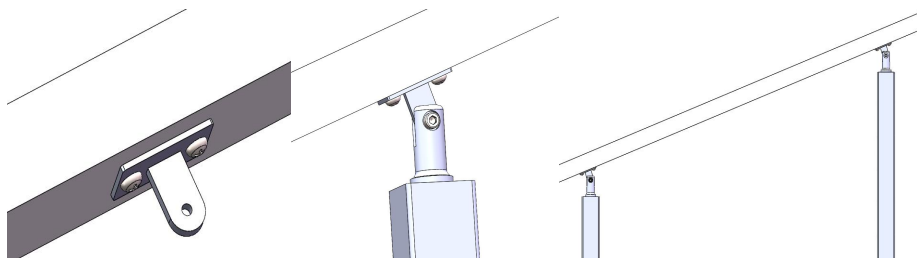

Het is ook geschikt voor de installatie van boogleuning en beugels.

Voor model HR-017

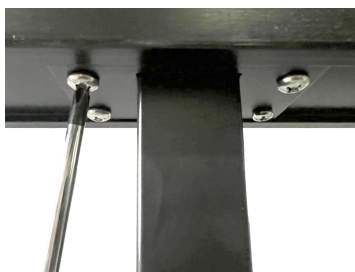
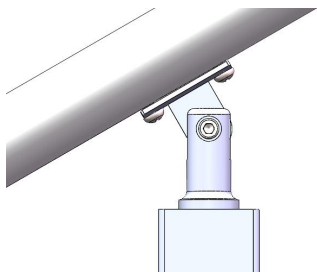

## Installeren met staalkabel en fittingen

Voor Level wielbeschermerhuls

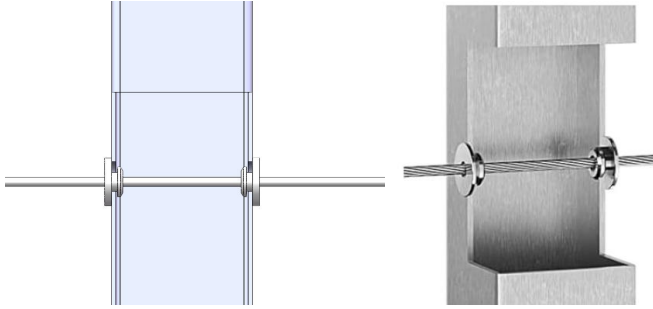

Voor noppenspanner Horizontale montage en hoek

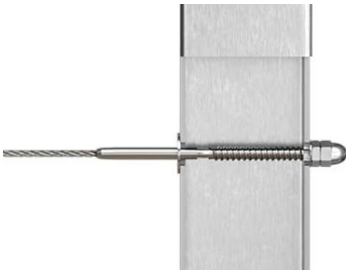

Voor spanschroefspanner en vaste terminal

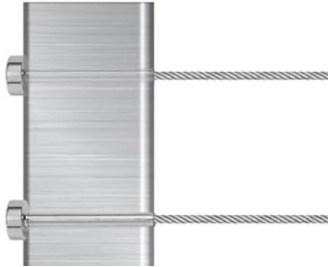

**Adres:** Baoshanqu Shuangchenglu 803long 11hao 1602A-1609shi  
Shanghai

**Geïmporteerd naar AUS:** SIHAO PTY LTD, 1 ROKEVA  
STREETEASTWOOD NSW 2122 Australië

**Geïmporteerd naar de VS:** Sanven Technology Ltd. Suite 250, 9166  
Anaheim Place, Rancho Cucamonga, CA 91730

<b>UK</b>	<b>REP</b>
-----------	------------

Pooledas Group Ltd  
Unit 5 Albert Edward House, The Pavilions  
Preston, United Kingdom

<b>EC</b>	<b>REP</b>
-----------	------------

SHUNSHUN GmbH  
Römeräcker 9 Z2021, 76351  
Linkenheim-Hochstetten, Germany

**Gemaakt in China**

**VEVOR**<sup>®</sup>

**TOUGH TOOLS, HALF PRICE**

**Technisch Ondersteuning en e-garantiecertificaat**

**[www.vevor.com/support](http://www.vevor.com/support)**

# **VEVOR®**

**TOUGH TOOLS, HALF PRICE**

Teknisk Support och e-garanticertifikat [www.vevor.com/support](http://www.vevor.com/support)

## **KABELRÄCKESSTOLPE**

**MODELL: HR-001/HR-002/HR-003/HR-004/HR-005/HR-006/HR-007/  
HR-008/HR-009/HR-010/HR-011/HR-012/HR-013/HR-014  
HR-015/HR-016/HR-017/HR-018/HR-019/HR-020/HR-021/  
HR-022/HR-023**

We continue to be committed to provide you tools with competitive price.

"Save Half", "Half Price" or any other similar expressions used by us only represents an estimate of savings you might benefit from buying certain tools with us compared to the major top brands and does not necessarily mean to cover all categories of tools offered by us. You are kindly reminded to verify carefully when you are placing an order with us if you are actually saving half in comparison with the top major brands.

# VEVOR®

TOUGH TOOLS, HALF PRICE

## CABLE RAILING POST

MODELL: HR-001/HR-002/HR-003/HR-004/HR-005/HR-006/HR-007/  
HR-008/HR-009/HR-010/HR-011/HR-012/HR-013/HR-014  
HR-015/HR-016/HR-017/HR-018/HR-019/HR-020/HR-021/  
HR-022/HR-023

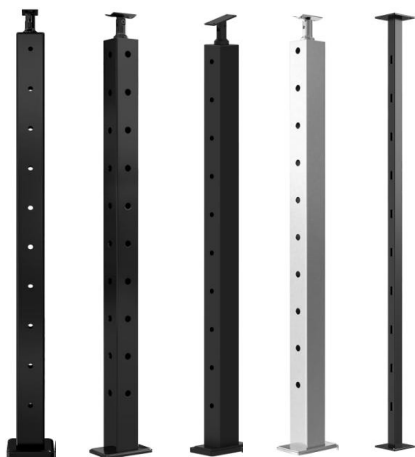

< Endast bild för referens > \_

### NEED HELP? CONTACT US!

Have product questions? Need technical support? Please feel free to contact us:

**Technical Support and E-Warranty Certificate**  
[www.vevor.com/support](http://www.vevor.com/support)

This is the original instruction, please read all manual instructions carefully before operating. VEVOR reserves a clear interpretation of our user manual. The appearance of the product shall be subject to the product you received. Please forgive us that we won't inform you again if there are any technology or software updates on our product.

## VIKTIGA SÄKERHETSÅTGÄRDER



**VARNING** : Läs och förstå hela denna manual innan du använder eller servar denna produkt. Underlåtenhet att följa dessa varningar och instruktioner kan orsaka personskada eller skada på värdefull egendom.

1. Varningen anger att lämpliga åtgärder bör vidtas för att undvika den potentiella faran för personskada.
2. Produktegenskaper gäller endast för korrekt och fullständigt monterad produkt.
3. Förvara små reservdelar utom räckhåll för barn, det är inte en leksak, låt inte barn leka .
- 4 . För ytterligare information om delarna som listas på följande sidor, se monteringsdiagrammet i denna manual. Packa upp och separera alla delar på ett rent arbetsområde.

### **SPARA DESSA INSTRUKTIONER**

## HUVUDFUNKTIONER

Denna produkt används huvudsakligen för pelarinstallation av trådfunktioner och dekorativa tillbehör .

VEVORs kabelräckesstolpe är tillverkad av alla material i rostfritt stål, vilket har stor motståndskraft mot rost och korrosion . Det kommer att fungera för lång livslängd för inre och yttre räcken med lågt underhåll. Observera att det inte rekommenderas för kustprojekt .

Vi arbetar med alla ansträngningar för att tillhandahålla kvalitetsprodukter och professionell service, och göra VEVOR till ett pålitligt varumärke.

## INSTALLATIONSANVISNING

### **Installationsindikation och tillämplig stolpe**

Tillämplig för alla tekniska installationsscenarier .

**Obs:** Denna produkt inkluderar endast pelaren och dess monteringsfästen, exklusive vajer, kabelräckessats, ledstång.

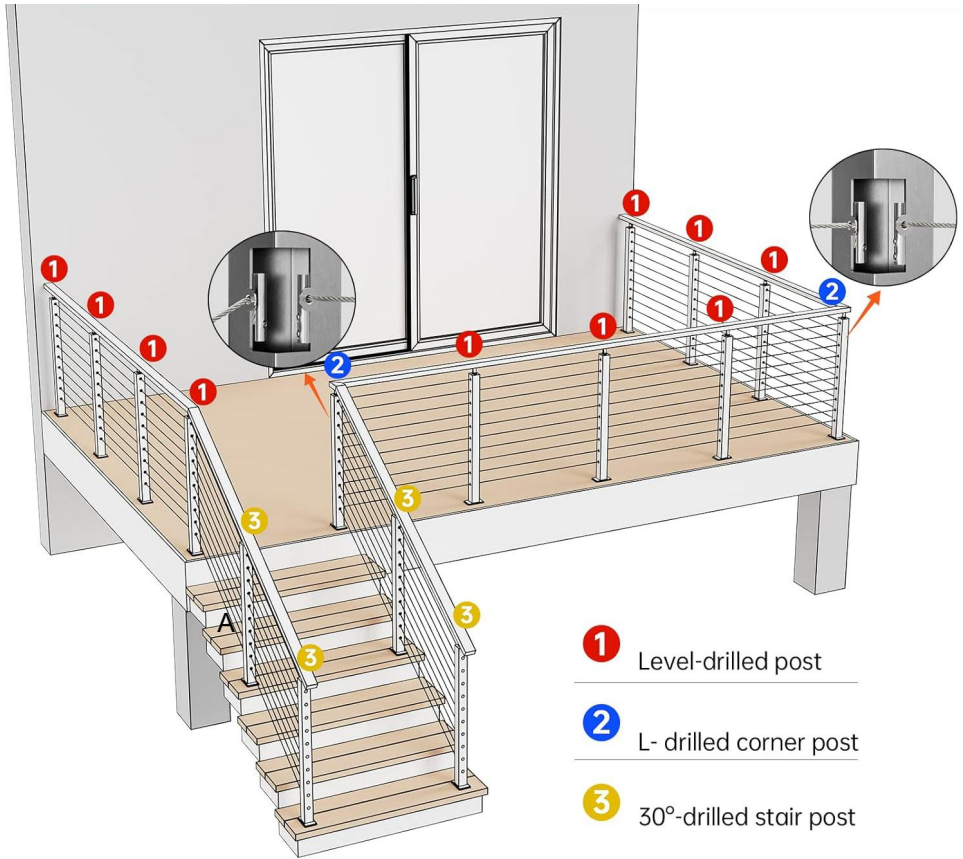

- 1** Level-drilled post
- 2** L- drilled corner post
- 3** 30°-drilled stair post

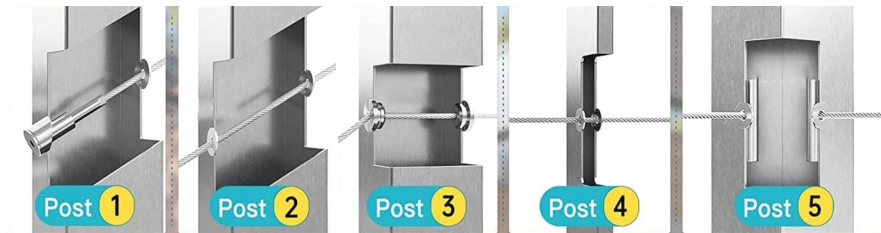

## PRODUKTINFORMATION

Model I	Borr ad	Höjd (mm)	Borra t num mer	Håldia meter (mm)	Hålstig ning (mm)	Sektion sstorlek (mm)	Färg	Inkludera (st)

<b>HR-001</b>	nivå	1067	12	φ10,5	80	50*50	Svart	4
<b>HR-002</b>	nivå	914	10	φ10,5	80	50*50	Svart	4
<b>HR-003</b>	nivå	1067	12	φ8	80	30*50	Svart	4
<b>HR-004</b>	nivå	914	10	φ8	80	30*50	Svart	4
<b>HR-005</b>	30°	1067	12	10,5×15	80	50*50	Silver	1
<b>HR-006</b>	30°	1067	12	10,5×15	80	50*50	Svart	1
<b>HR-007</b>	L	1067	12	φ10,5	80	50*50	Svart	1
<b>HR-008</b>	Ej	914	/	/	/	50*50	Svart	1
<b>HR-009</b>	nivå	914	10	φ10,5	80	50*50	Svart	1
<b>HR-010</b>	30°	914	10	10,5×15	80	50*50	Svart	1
<b>HR-011</b>	L	914	10	φ10,5	80	50*50	Svart	1
<b>HR-012</b>	nivå	914	10	φ10,5	80	50*50	Silver	1
<b>HR-013</b>	30°	1067	12	8×13	80	30*50	Svart	1
<b>HR-014</b>	L	1067	12	φ8	80	30*50	Svart	1
<b>HR-015</b>	30°	914	10	8×13	80	30*50	Svart	1
<b>HR-016</b>	L	914	10	φ8	80	30*50	Svart	1

HR-0 17	Ej	914	/	/	/	38*38	Svart	1
HR-0 18	nivå	1067	12	φ8	80	30*50	Svart	1
HR-0 19	Ej	1067	/	/	/	50*50	Svart	1
HR-0 20	nivå	914	10	φ8	80	30*50	Svart	1
HR-0 21	nivå	1067	12	φ10,5	80	50*50	Svart	1
HR-0 22	nivå	914	10	Φ 8	80	3 0*50	Silver	1
HR-0 23	nivå	1067	12	φ10,5	80	50*50	Silver	1

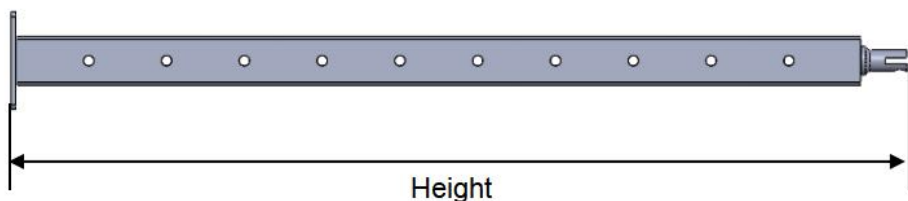

## PAKET OMFATTA

Nej	Komponenter	Bild	ANTAL				
			Passande modell				
			HR-001 / HR-002	HR005~HR0 12/HR-019/ HR-0 21/ HR-0 23/	HR-00 3/ HR-00 4	HR-013 ~ HR-01 6/ HR-018 / HR-0 20/ HR-0 22/	HR-0 17
1	posta		4	1	4	1	/
			/	/	/	/	1
2	Fyrkantigt omslag		4	1	/	/	/

3	Rektangulärt omslag		/	/	4	1	/
4	ankarbult		16	4	16	4	4
5	Böjt fäste		4	1	4	1	/
6	Horisontellt fäste		4	1	4	1	/
7	insexnyckel		4	1	4	1	1
8	Öppen skiftnyckel		4	1	4	1	1
9	Plåtskruv		8	2	8	2	4
10	Plastöverdrag		/	/	/	/	1

## INSTALLATION

### För betong- eller trägolv

		
<p>Steg 1. Markera borrhänderna på lämpliga installationsplatser.</p>	<p>Steg 2. Använd en hammarbore för att göra ett hål för <math>\varnothing</math> 12 vid de markerade punkterna.</p>	<p>Steg 3. Slå in ankarskruven i det borrhända hålet.</p>

	
<p>Steg 4. Dra åt skruvarna</p>	<p>Steg 5. Stäng locket och slutför fixeringen av stolpen.</p>

**Obs:** Se till att pelaren är upprätt när du fäster stolpens bottenplatta.

## Montera med ledstång (horisontell)

Steg 1: Fast fäste

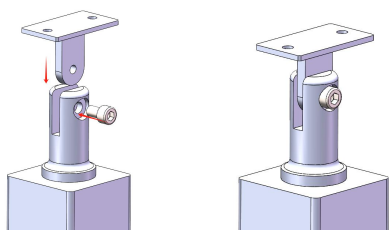

Steg 2: Bestäm monteringspositionen för ledstången och markera sedan positionen under ledstången och fästhålen och borra hål med en  $\varnothing 5,5$ - $\varnothing 5,6$  mm borrar.



Steg 3: Använd de självgående skruvarna i tillbehöret för att fästa ledstången på stödet.



Det är också lämpligt för montering av bågräcken och konsoler.

## Montera med ledstång (lutning)

Steg 1: Fast fäste

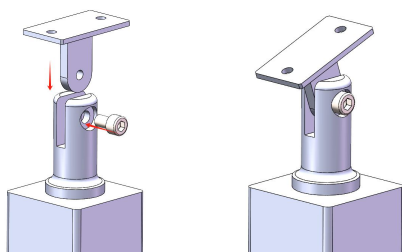

Steg 2: Justera vinkeln på fästet så att det passar undersidan av ledstången. Bestäm monteringspositionen för ledstången och markera sedan positionen under ledstången och fästets hål och borra hål med en  $\varnothing 5,5$ - $\varnothing 5,6$  mm borrar.

**Obs: Ledstången och fästet kan förfixeras med hjälp av spännverktyg, så att flera monteringspunkter för fästet kan markeras och placeras samtidigt.**

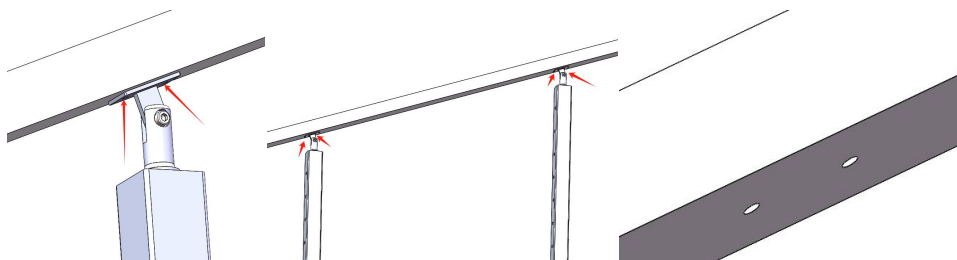

Steg 3: Ta bort fästet från stolpen och använd sedan de självgående skruvarna i tillbehöret för att fästa fästet på ledstången.  
Fixa stolpen och fästet igen .

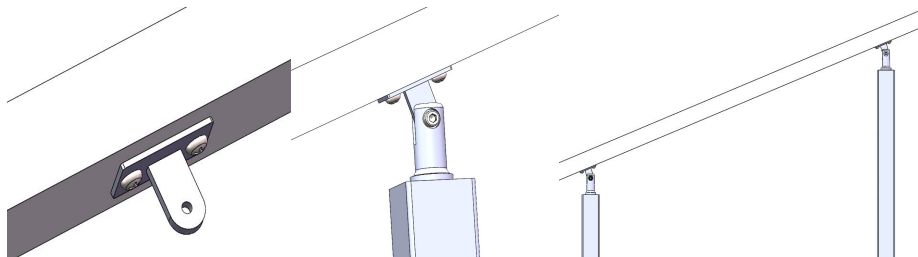

Det är också lämpligt för montering av bågräcken och konsoler.

För modell HR-017

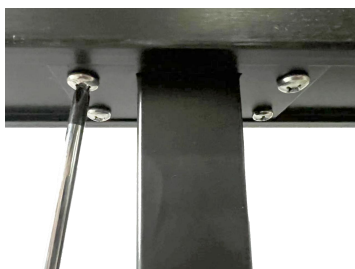
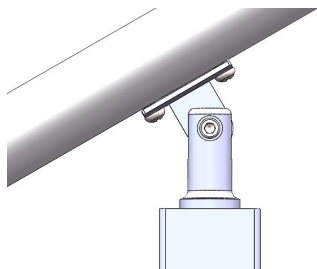

## Installera med stållina och beslag

För nivåhjulsskyddshylsa

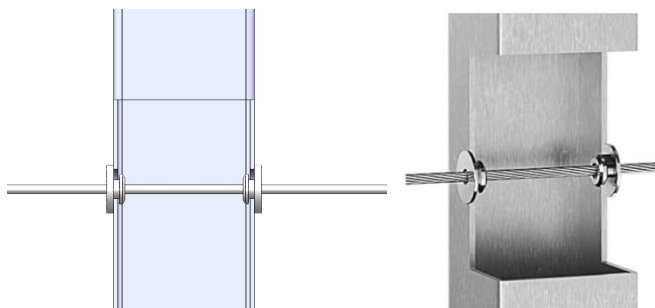

För Dubbspännare Horisontell montering och Vinkel

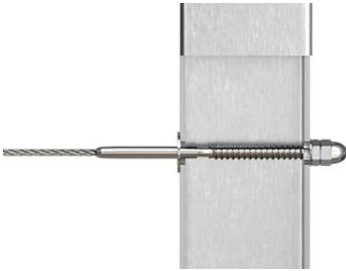

För spännskruv och fast anslutning



**Adress:** Baoshanqu Shuangchenglu 803long 11hao 1602A-1609shi  
Shanghai

**Importerad till AUS:** SIHAO PTY LTD, 1 ROKEVA STREETEASTWOOD  
NSW 2122 Australien

**Importerad till USA:** Sanven Technology Ltd. Suite 250, 9166 Anaheim  
Place, Rancho Cucamonga, CA 91730

<b>UK</b>	<b>REP</b>
-----------	------------

Pooledas Group Ltd  
Unit 5 Albert Edward House, The Pavilions  
Preston, United Kingdom

<b>EC</b>	<b>REP</b>
-----------	------------

SHUNSHUN GmbH  
Römeräcker 9 Z2021, 76351  
Linkenheim-Hochstetten, Germany

**Tillverkad i Kina**



**VEVOR**<sup>®</sup>

**TOUGH TOOLS, HALF PRICE**

**Teknisk Support och e-garanticertifikat**

**[www.vevor.com/support](http://www.vevor.com/support)**