

RSG257AA

# Refrigerator user manual

English

imagine the possibilities

Thank you for purchasing this Samsung product.  
To receive more complete service,  
please register your product at  
[www.samsung.com/global/register](http://www.samsung.com/global/register)

**SAMSUNG**

# Features of your new Refrigerator

---

## KEY FEATURES OF YOUR NEW REFRIGERATOR

---

Your Samsung Side-By-Side Refrigerator comes equipped with many space-saving, innovative storage and energy-efficient features.

- **Twin Cooling Plus™**

The Refrigerator and Freezer have separate evaporators. Due to this independent cooling system, the Freezer and Refrigerator cool more efficiently. Additionally, this separate air flow system prevents food odor of one compartment from seeping into other compartments.

- **Multi Airflow**

Provides even cooling throughout the refrigerator to maintain optimal temperatures to keep food fresh.

- **LED Tower Lighting**

See everything in a new light with LED tower lighting.

- **Premium Design Ice and Water Dispenser**

Quick and easy access to filtered water and cubed/crushed ice with the external dispenser.

- **External Digital Display and Control**

Controlling the refrigerator is easy with the external digital display. It shows the inside temperatures, when to change your filter and also controls the ice and water dispenser.

- **Clear View Icemaker**

The Icemaker is located in the freezer door, this ensures that all the freezer shelf space can be fully utilized. Ice cubes are quickly produced and the clear ice bucket lets you easily see the amount of ice cubes produced.

- **Auto-moisture Drawer**

A “Shape Memory Polymer” is equipped on the “Auto-moisture Drawer(crisper)”, which provides automatic humidity control. To maintain the optimal humidity in the crisper, the fine-mesh holes in the polymer control the flow of moisture.



For easy future reference write the model and serial number down. You will find your model number on the left hand side wall of the refrigerator.

Model # \_\_\_\_\_

Serial # \_\_\_\_\_











# Safety Information

## SAFETY INFORMATION

Before using your new Samsung Side-By-Side Refrigerator, please read this manual thoroughly to ensure that you know how to safely and efficiently operate the features and functions that your new appliance offers.

Because the following instruction covers various models, the characteristics of your Refrigerator may differ slightly from the Refrigerator described in this manual. If you have any question, contact us at 1-800-SAMSUNG or find help and information online at [www.samsung.com](http://www.samsung.com).

What the icons and signs in this user manual mean :

 <b>WARNING</b>	Hazards or unsafe practices that may result in <b>severe personal injury or death</b> .
 <b>CAUTION</b>	Hazards or unsafe practices that may result in <b>minor personal injury or property damage</b> .
 <b>CAUTION</b>	To reduce the risk of fire, explosion, electric shock, or personal injury when using your refrigerator, follow these basic safety precautions:
	Do NOT attempt.
	Do NOT disassemble.
	Do NOT touch.
	Follow directions explicitly.
	Unplug the power plug from the wall socket.
	Make sure the machine is grounded to prevent electric shock.
	Call the service center for help.

**These warning signs are here to prevent injury to you and others.**

**Please follow them explicitly**

**Keep this manual in a safe place for future reference.**

## SEVERE WARNING SIGNS

-  **Do not plug several appliances into the same power socket.**
  - Large appliances draw a lot of power. Powering more than one appliance or machine from a single power source could cause overheating and cause a fire.

**Make sure that the power plug is not kinked or damaged by the back of the Refrigerator.**

- A damaged power plug may overheat and cause a fire.

**Do not spray water directly into or on the outside of the Refrigerator/Freezer drawer.**

- Water could get into the interior machine parts and cause electric shock.

**Do not use aerosols near the Refrigerator.**

- Aerosols used near the Refrigerator may cause an explosion or fire.

# Safety Information

---

**Do not put undue stress on the power cord or place heavy articles on it.**

- Placing heavy articles on the power cord create the risk of explosion or fire.

**Do not insert the power plug with wet hands.**

- It may cause electric shock.

**Do not put a container filled with water on the Refrigerator.**

- If it spills, it may cause fire or electric shock.

**Do not install the Refrigerator in a damp place or place where it may come in contact with water.**

- Wet and/or deteriorated insulation of the internal electrical parts may cause electric shock or fire.

**Do not store volatile or flammable substances in the Refrigerator.**

- Storing benzene, thinner, alcohol, ether, LP gas and other such products may cause explosions.



**Do not disassemble or repair the Refrigerator by yourself.**

- You may run the risk of fire, appliance malfunctions and/or personal injury. Call your nearest service center for help from a qualified service technician.



**Unplug the Refrigerator before changing the interior light.**

- Changing the light while the Refrigerator is plugged in may cause electric shock.

**If you wish to dispose of the Refrigerator, remove the doors and seals before throwing it away.**

- The doors(and their seals) can entrap a child if they climb into the Refrigerator. Make sure that the doors are off, and ensure that no one is suffocated by being locked inside.



**The Refrigerator must be safely grounded**

- Always make sure that you have grounded the Refrigerator before attempting to investigate or repair any part of the appliance. Power leakages can cause severe electric shock.

**Never use gas pipes, telephone lines or other potential lightning attractors as an electrical ground.**

- Improper use of the grounding plug can result in a risk of electric shock. If it is necessary to use an extension cord to power the Refrigerator, use only a 3-wire extension cord that has a 3-blade ground plug and a 3-slot receptacle that will accept the plug on the appliance. The marked rating of the extension cord should be AC 115V~120V, 10A, or more. Additionally, if a grounding adapter is used, make sure the receptacle box is also fully grounded.

## CAUTION SIGNS

---



### **Use good judgment when filling the Refrigerator with food and drinks.**

- In an overfull Refrigerator, heavy, fragile, bulky or breakable items may fall out and cause personal injury and/or damage to surrounding objects.

### **Do not put bottles or glass containers in the Freezer drawer.**

- When the contents freeze and then expand, the glass may break and cause personal injury or leave dangerous glass shards in the Freezer.

### **If the electrical wall socket is loose, do not insert the power plug.**

- There is a risk of electric shock or fire. Have the plug looked at by a licensed electrician.



### **Never unplug your Refrigerator by pulling on the power cord.**

- Always grip the power cord firmly and pull straight out from the outlet. Yanking or pulling on the power cord may cause a short-circuit, fire and/or electric shock.
- A damaged power cord must be replaced by the manufacturer, a certified service agent or qualified service personnel.

### **Do not store articles on the top of the appliance.**

- When you open or close the door, the articles may fall and cause personal injury and /or damage to surrounding objects.

### **Do not store pharmaceutical products, scientific materials and temperature-sensitive products in the refrigerator.**

- Products that require exact temperature controls should not be stored in the Refrigerator.



**Do not allow children to climb, stand or hang on shelves and handles of the Refrigerator. They could damage the Refrigerator and seriously injure themselves. Do not sit on the freezer door. The door may break. Do not allow children to climb into the freezer basket.**



**If you notice a chemical or burning plastic smell or see smoke, unplug the Refrigerator immediately and contact your Samsung Electronics Service Center.**



**After your Refrigerator is in operation, do not touch the cold surfaces in the Freezer compartment. Particularly when hands are damp or wet, skin may adhere to these extremely cold surfaces.**

- Skin may stick to the surface and you may get frostbite.

### **Do not put your hands under the appliance.**

- Any sharp edges may cause personal injury.

# Safety Information

---

**Never put fingers or other objects into the water dispenser hole or ice chute.**

- It may cause personal injury and/or material damage.



**If the Refrigerator will not be used for a long period of time (for example, over several months), unplug the power from the wall.**

- Over time, deterioration in the power cord insulation may cause fire.



**Do not use a wet or damp cloth when cleaning the plug.**

**Remove any dust or foreign matter from the power plug pins.**

- A dirty power plug can increase the risk of fire.

**If the Refrigerator is disconnected from the power supply, you should wait for at least five minutes before plugging it back in.**



**Do not place the refrigerator directly in sunlight.**

**The appliance must be positioned for easy access to power source.**

**If the power cord is damaged, it must be replaced by the manufacturer, a certified service agent or qualified service personnel.**

**If you have a long vacation planned, empty the Refrigerator and turn it off.**

- Wipe excess moisture from the inside and leave the doors open to keep odor and mold from developing.



**Service warranty and Modification**

- Any changes or modifications performed by a 3rd party on this finished appliance is not covered under Samsung warranty service, nor can Samsung be responsible for safety issues that result from 3rd party modifications.



**Children can get trapped inside Refrigerators.**

**Before you throw away your old Refrigerator or Freezer, make sure that you;**

- Take off the doors.
- Leave all shelves in places so that children may not easily climb inside and shut the door while they are inside.



**This appliance is not intended for use by small children or infirm persons without capable, adult supervision. Small children should be supervised when using the appliance.**



**Do not block air holes**

- If the air holes are blocked, especially with a plastic bag, refrigerator can be over cooled. If this cooling period lasts long, the water filter may break and cause water leakage.

# Contents

---

## **SETTING UP YOUR SIDE-BY-SIDE REFRIGERATOR**

08

- 8 Getting ready to install the refrigerator
- 10 Setting up the refrigerator doors
- 13 Levelling the refrigerator
- 14 Making minor adjustments to the doors
- 15 Checking the water dispenser line
- 16 Installing the water line

## **OPERATING THE SAMSUNG SIDE-BY-SIDE REFRIGERATOR**

18

- 18 Using the control panel/Digital display
- 20 Controlling the temperature
- 21 Using the ice and cold water dispenser
- 22 Storing food
- 24 Removing the freezer/fridge accessories
- 25 Cleaning the refrigerator
- 26 Changing the interior lights, the water filters
- 27 Using the doors
- 28 Before using icemaker

## **TROUBLESHOOTING**

29

- 29 Troubleshooting

## **WARRANTY**

30

- 30 Warranty

# setting up your side-by-side refrigerator

## GETTING READY TO INSTALL THE REFRIGERATOR

Congratulations on the purchase of your Samsung Side-By-Side Refrigerator. We hope you will enjoy the many state-of-the-art features and efficiencies that this new appliance has to offer.

### Selecting the best location for the refrigerator

- Select a location with easy access to the water supply.
- Select a location without direct exposure to sunlight.
- Select a location with level (or nearly level) flooring.
- Select a location with enough space for the refrigerator doors to open easily.
- Allow sufficient space to install the refrigerator on a flat surface.
  - If your refrigerator is not level, the internal cooling system may not work correctly.
  - Overall space required in use. Refer to drawing and dimension as below.

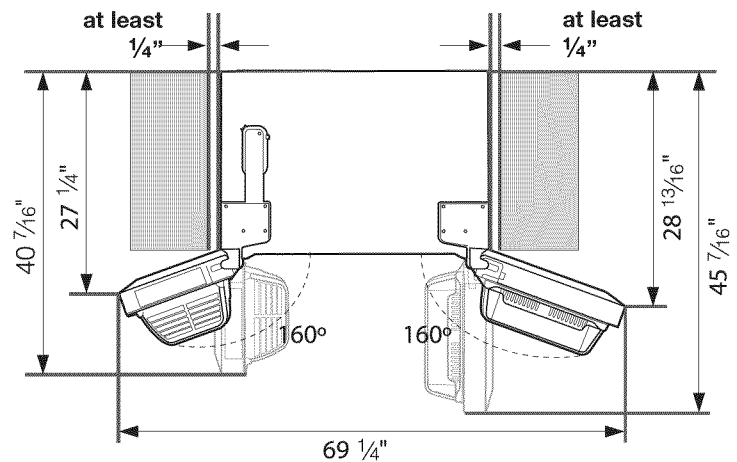
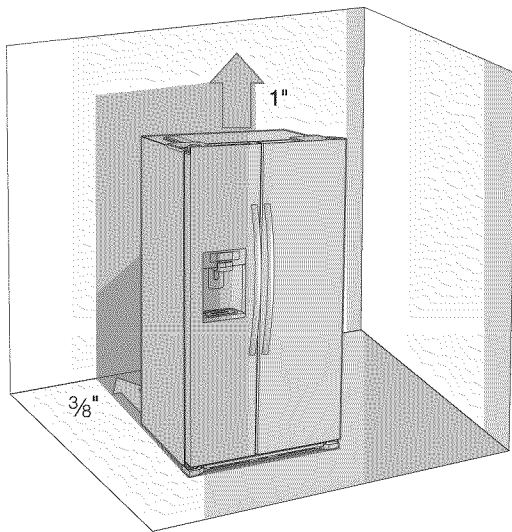

### When moving your refrigerator

To prevent floor damage, be sure the front levelling legs are in the up position (above the floor). Refer to 'Levelling the refrigerator' in the manual (page 12).

To protect the finish of the flooring, place a protection sheet, such as packing carton under the refrigerator.

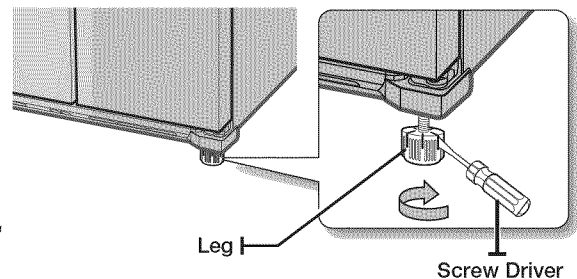

When installing, servicing or cleaning behind the refrigerator, be sure to pull the unit straight out and push back in straight after finishing.

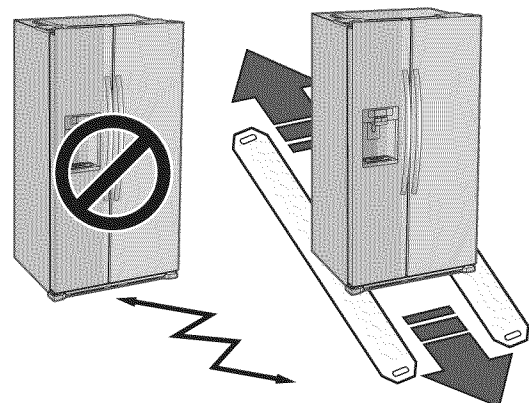

First things first! Make sure that you can easily move your refrigerator to its final location by measuring doorways (both width and height), thresholds, ceilings, stairways, etc. The following chart details the exact height and depth.

MODEL		RSG25**	
Dimensions(inch)	Width	Only Cabinet	35 3/4
		With Leg Front	35 15/16
	Depth	Only Cabinet	23 5/8
		With Door	27 7/16
		With Handle	30
	Height	Only Cabinet	68 5/8
		With Hinge	69 5/16
		With Door	70

-  • Allow clearance to the right, left, back and top when installing. This will help reduce power consumption and keep your energy bills lower.
- Do not install the refrigerator where the temperature can drop below 50°F (10°C).
- Make sure you disconnect the water supply line BEFORE removing the freezer door. See the next section on “Separating the Water Line” to avoid damage.

## SETTING UP THE REFRIGERATOR

Now that you have your new Refrigerator installed in place, you are ready to set up and enjoy the features and functions of the appliance. By completing the following steps, your Refrigerator should be fully operational. If not, first check the power supply and electricity source or try the troubleshooting section at the back of this user’s guide. If you have any further questions, contact your Samsung Electronics service center.

1. Place the Refrigerator in an appropriate location with reasonable clearance between the wall and the Refrigerator. Refer to installation instructions in this manual.
2. Once the Refrigerator is plugged in, make sure the interior light comes on when you open the doors.
3. Set the Temperature control to the coldest temperature and wait for an hour. The Freezer will get slightly chilled and the motor will run smoothly.
4. After powering the Refrigerator, it will take a few hours to reach the appropriate temperature. You can store food and drinks in the Refrigerator after the temperature is sufficiently cool.

 Check the accessory list below.



Water filter  
(DA29-00003B)



Hex wrench  
(DA80-00002C)



Compression fitting  
(DA62-00305A)



Compression nut  
(DA74-00070B)



Clip  
(DA61-04521A)

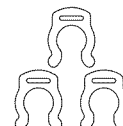

Clip  
(DA61-04522A)



Screw  
(6001-000541)

# setting up your side-by-side refrigerator

## SETTING UP THE REFRIGERATOR DOORS

If your entrance won't allow the refrigerator to pass easily through it, you can remove the doors.

### Removing the Front Leg Cover

First, open both the freezer and refrigerator doors, and then take off the front leg cover by turning the three screws counter-clockwise

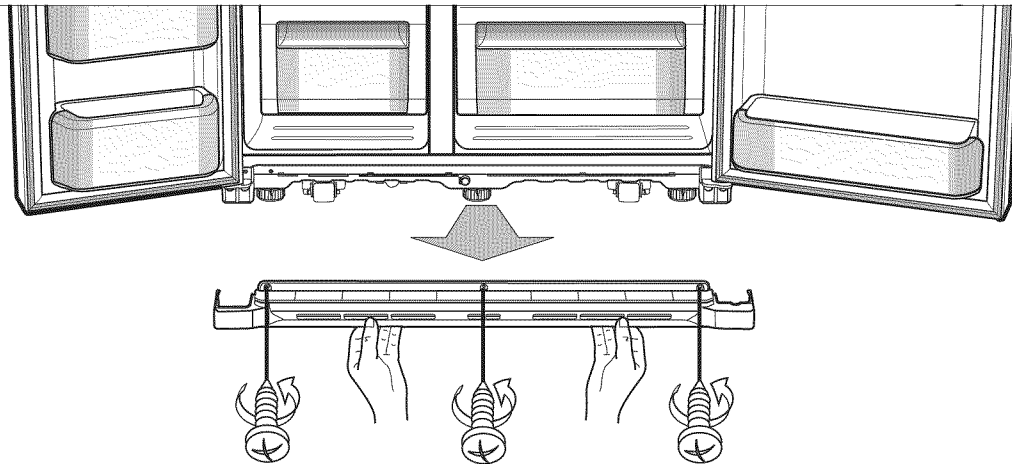

### Separating the Water Supply Line from the Refrigerator

1. Remove the water line (gray and transparent colors) by pressing the coupler **1** and pulling the water line **2** away.

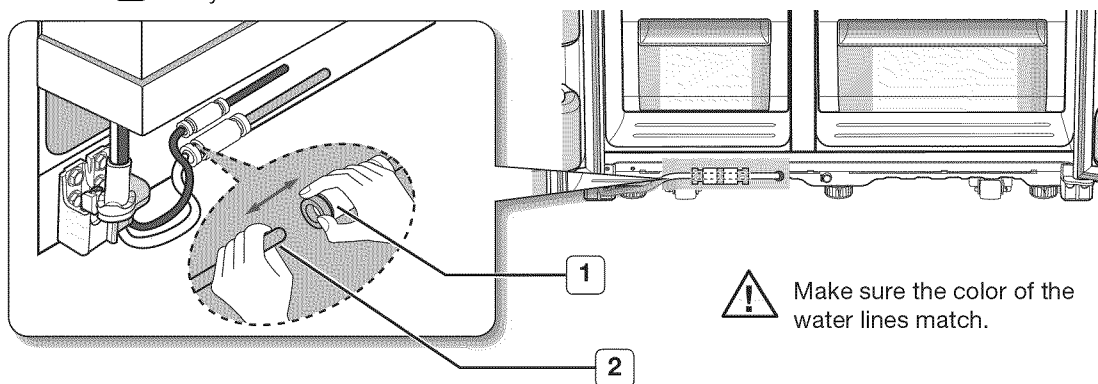

### Reattaching the Water Supply Line

1. The Water Line must be fully inserted to the marked line to prevent water leakage from the dispenser.
2. Insert the 4 clips in the install pack and check that each clip holds the line firmly.

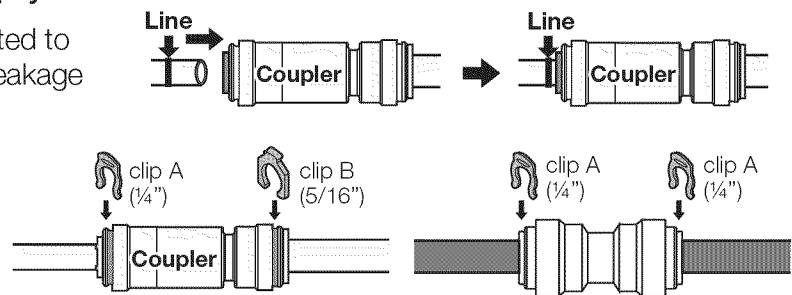

 Do not cut the water line. Gently separate it from the coupler.

## Removing the freezer door

A few things to mention first.

- Make sure that you lift the door straight up so the hinges are not bent or broken.
  - Be careful not to pinch the water tubing and wire harness on the door.
  - Place doors on a protected surface to prevent scratching or damage.
1. With the Freezer door closed, remove the upper hinge cover **1** and wire cover **2** using a screwdriver, and then disconnect the wires by gently pulling them apart **3**.

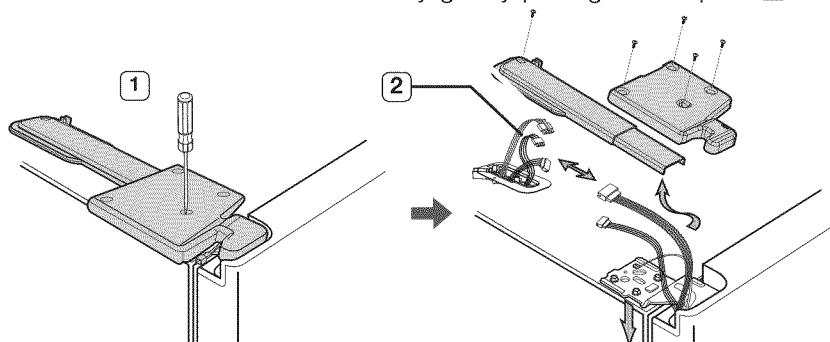

2. Remove hinge screws **4** and the ground screw **5** by turning counter-clockwise, and take off the upper hinge **6**. Be careful that the door does not fall on you as you are removing it

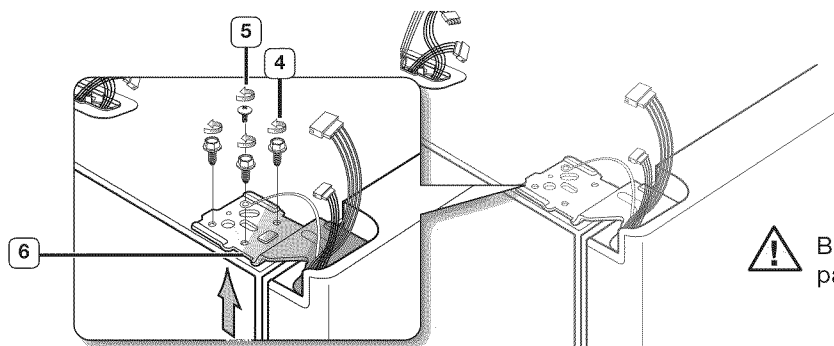

⚠ Be sure to keep track of all parts you are removing.

3. Next, remove the door from the lower hinge **7** by carefully lifting the door straight up **8**.

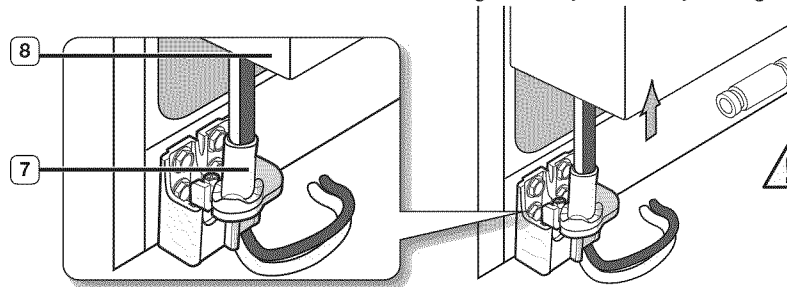

⚠ Be careful not to pinch the water tubing and wire harness on the door.

4. Remove the lower hinge **9** from the bracket **10** by gently lifting the lower hinge upwards.

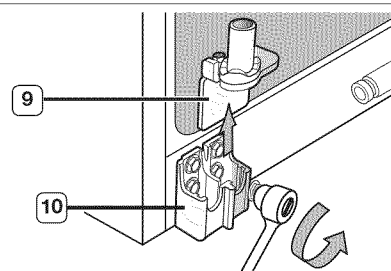

## Reattaching the freezer doors

⚠ To reattach the freezer doors, replace parts in reverse order

## Removing the Fridge Door

1. With the door closed, remove the upper hinge cover **1** using a screwdriver.

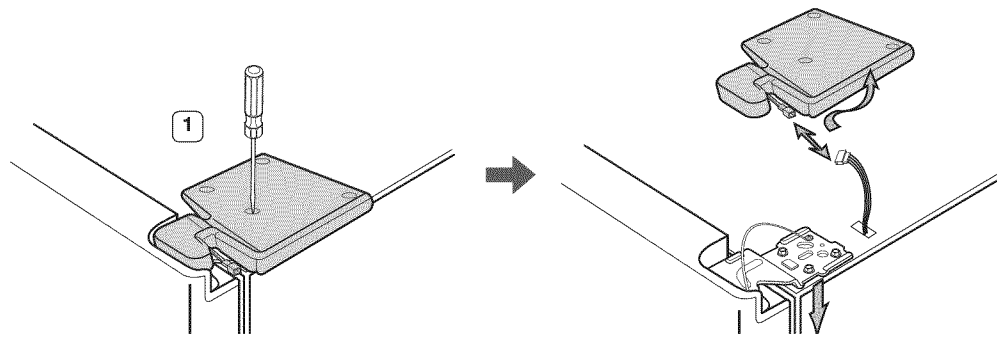

2. Remove hinge screws **2** and the ground screw **3** by turning counter-clockwise, and take off the upper hinge **4**. Be careful that the door does not fall on you as you are removing it.

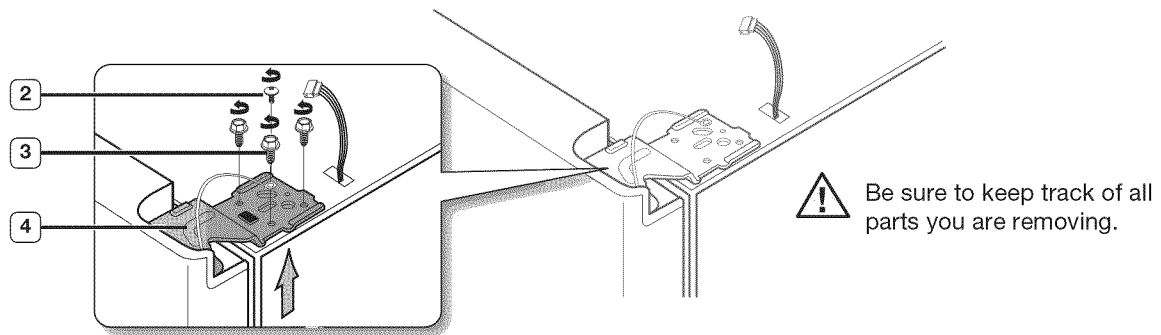

3. Remove the door from the lower hinge **5** by lifting the door straight up **6**.

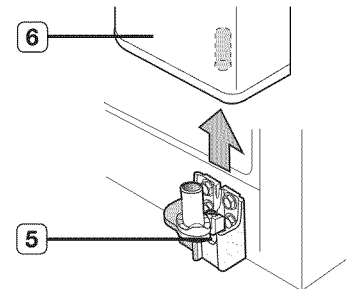

4. Remove the lower hinge **7** from the bracket **8** by gently lifting the lower hinge upwards.

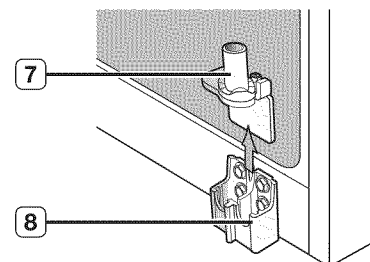

## Reattaching the Fridge door

**!** To reattach the fridge doors, replace parts in reverse order.

## Fixing the Doors

Fix the Doors by replacing 2 screws (in the accessory pack) as shown after finishing all operations.

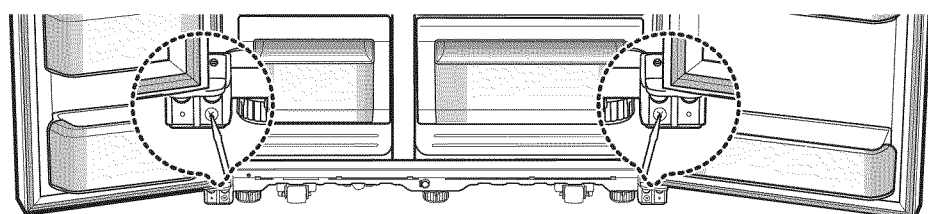

## LEVELLING THE REFRIGERATOR

Now that the doors are back on the refrigerator, you want to make sure the refrigerator is level so that you can make final adjustments. If the refrigerator is not level, it will not be possible to get the doors perfectly even.

 The front of the refrigerator is also adjustable.

### Before levelling the refrigerator, remove the front leg cover

Open both the freezer and fridge doors, and then take off the front leg cover by turning the three screws counter-clockwise.

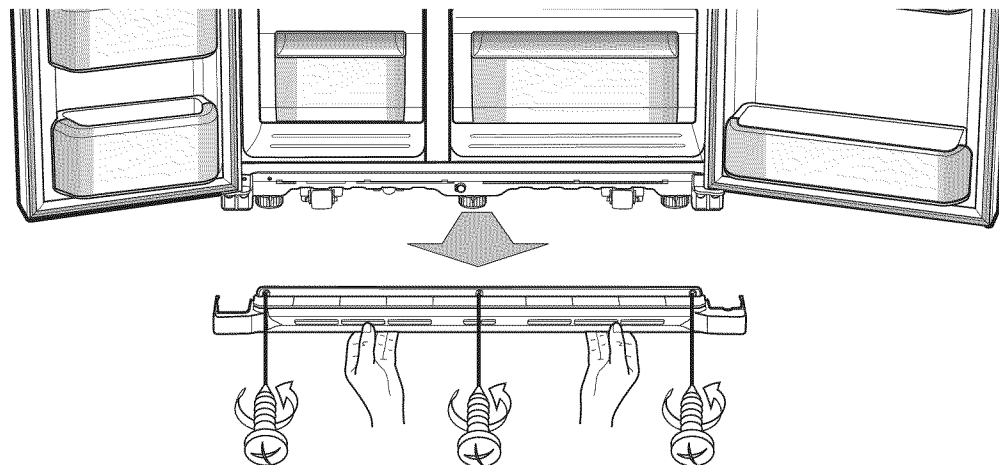



### When the Freezer part is lower than the Fridge part.

Insert a flat-blade screwdriver into a slot on the Freezer Leg, then turn it clockwise.

### When the Fridge part is lower than the Freezer part.

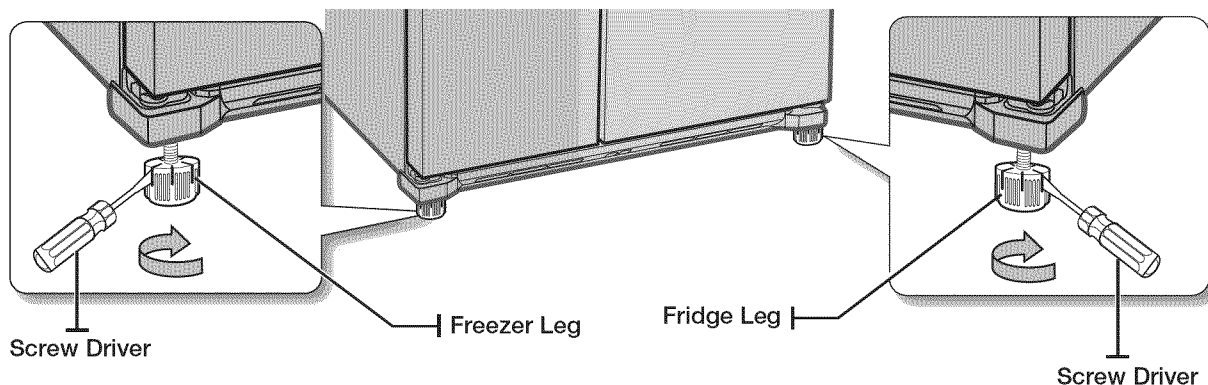
Insert a flat-blade screwdriver into a slot on the Fridge Leg, then turn it clockwise.



 Refer to the next section for the best way to make very minor adjustments to the doors.

## MAKING MINOR ADJUSTMENTS TO THE DOORS

Remember, a level refrigerator is necessary for getting the doors perfectly even. If you need help, review the previous section on levelling the refrigerator.

**When the door of the freezer is higher than the fridge**

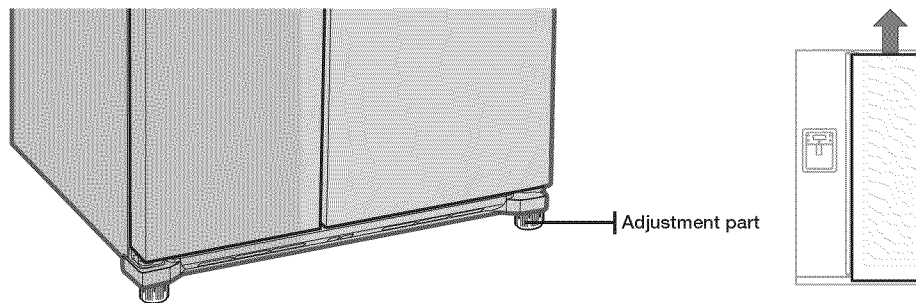

In the case of the process to correct the imbalance is the same. Open the doors and adjust them, one at a time, as follows:

1. Unscrew the nut **1** from the lower hinge until it reaches the upper end of the bolt **2**.

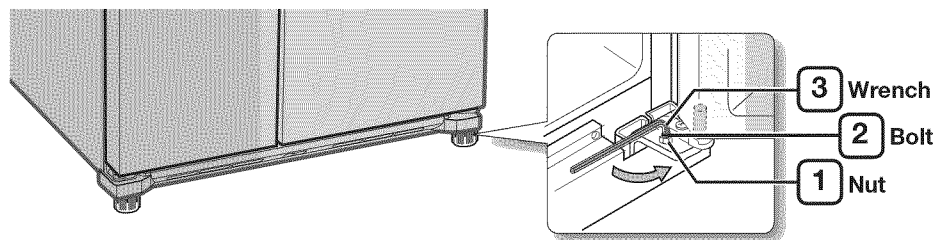

-  When you release the nut **1**, make sure that you use the Allen wrench provided **3** to loosen the bolt **2** in a counter-clockwise direction. You should then be able to unscrew the nut **1** with your fingers.

2. Adjust the height difference between the doors by turning the bolt **2** clockwise  or counter clockwise .

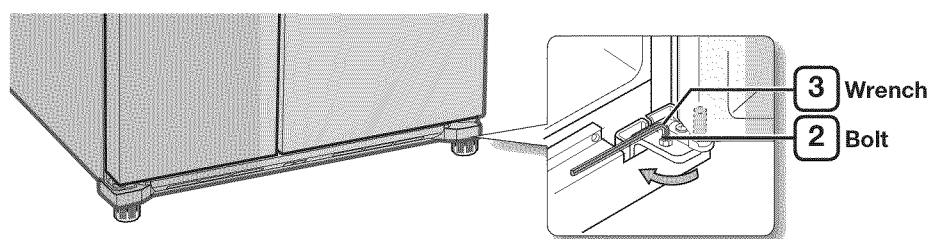

-  When you turn clockwise , the door will move up.

3. After adjusting the doors, turn the nut **1** clockwise  until it reaches the lower end of the bolt, then tighten the bolt again with the wrench **3** to fix the nut in place **1**.

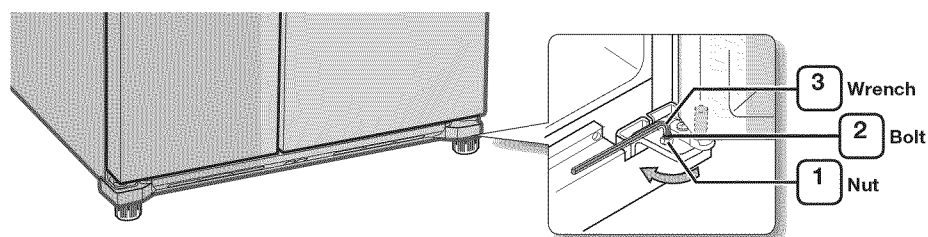

-  If you do not secure the nut firmly, the bolt may release.

## CHECKING THE WATER DISPENSER LINE

A water dispenser is one of the helpful features on your new Samsung Refrigerator. To help promote better health, the Samsung water filter removes unwanted particles from your water. However, it does not sterilize or destroy microorganisms. You may need to purchase a water purifying system to do that.

In order for the ice maker to operate properly, a water pressure of 20~125 psi (pound per square inch) is required. Under normal conditions, a 170 cc (5.75 oz.) paper cup can be filled in 10 seconds.

If the Refrigerator is installed in an area with low water pressure (below 20psi), you can install a booster pump to compensate for the low pressure.

Make sure the water storage tank inside the Refrigerator is properly filled. To do this, press the water dispenser lever until the water runs from the water outlet.

-  Water line installation kits are available at extra cost from your dealer. We recommend using a water supply kit that contains copper tubing.

### Connecting to the water supply line

1. First, shut off the main water supply line and turn the ice-maker off.
2. Locate the nearest cold, drinking water line.
3. After connecting the water supply to the water filter, turn your main water supply back on and flush four or more gallons into a bucket to clear and prime the water filter.

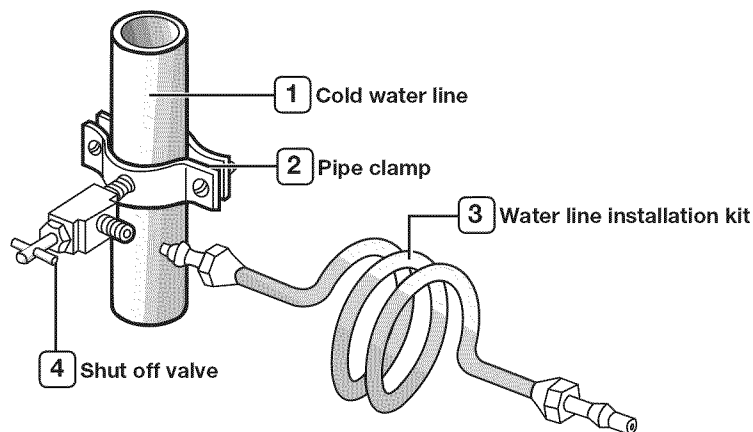

# setting up your side-by-side refrigerator

## INSTALLING THE WATER LINE

### Connecting the water line to the Refrigerator.

There are several items that you need to purchase to complete this connection. You may find these items sold as a kit at your local hardware store.

- 1/4" compression nut
- plastic tubing
- copper tubing
- ferrule

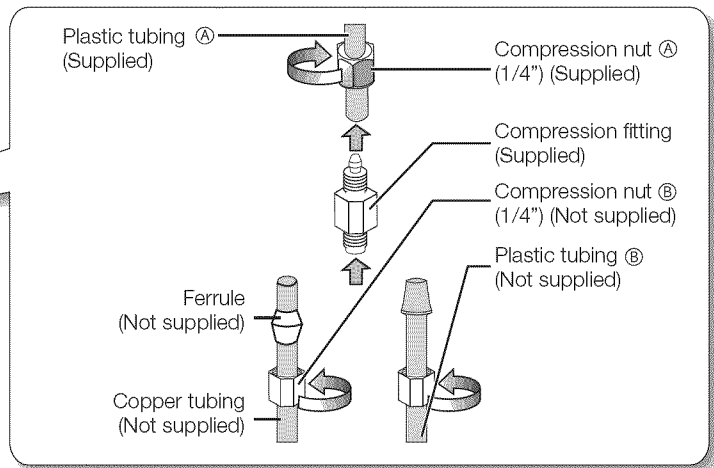
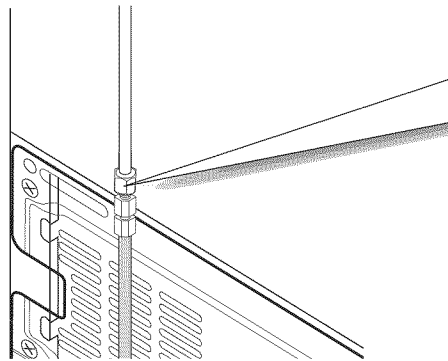

1. Slip the compression nut (A) through the supplied plastic tubing (A).
2. Tighten the compression nut (A) onto the 1/4" compression fitting.
  - If you are using copper tubing, slip the compression nut (B) (not included) and ferrule (not included) on copper tubing (not included) as shown.
  - If you are using plastic tubing (B), insert the molded end of the plastic tubing (B) into the compression fitting.
3. Tighten the compression nut (B) onto the compression fitting. Do not over-tighten the compression nut (B).
4. Turn water on and check for any leakage.



Only connect the water line to a drinkable water source.

If you have to repair or disassemble the water line, cut off 1/4" of the plastic tubing to make sure you get a snug, leak-free connection.

### Installing the water filter.



Before installing the water filter, please remove the top shelf.

1. Remove the water filter cover (1)
2. Remove the fixed cap by turning it counter clockwise. Keep the cap in a safe place for later use if you don't use a filter.
3. Remove the water filter from the box and put a replacement indicator sticker on the filter as shown. Place a sticker on the filter that dates six months in the future. For example, if you install the water filter in March, put the "SEP" sticker on the filter to remind you to replace in September. That way you'll know when it is time to replace the filter. Normally, a filter life is about 6 months.

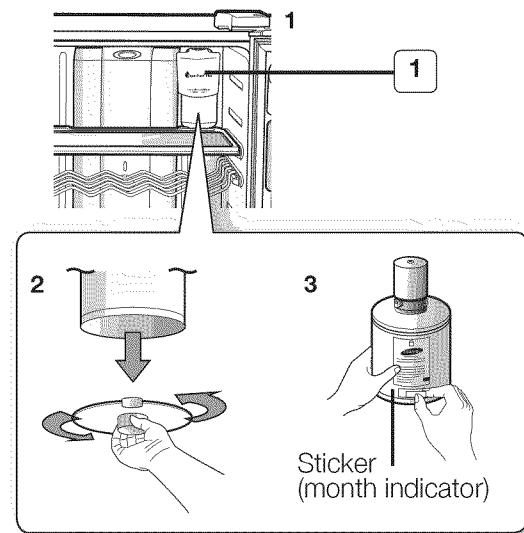

- Remove the filter cap and insert the filter into the filter housing.
- Slowly turn the water filter 90° clockwise to align with the printing mark on the cover, locking the filter in position. Make sure to align the water filter label mark with center of cover filter printing as illustrated. Remember, do not over-tighten.

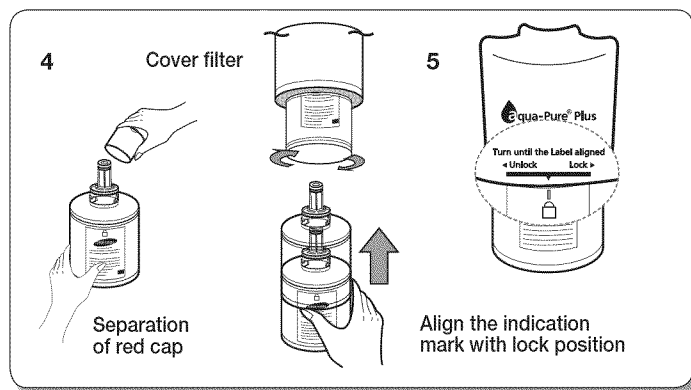

## Removing any residual matter inside the water supply line after installing filter.

- Turn ON the main water supply.
- Press the water button and push the dispenser pad.
- Run water through the dispenser until the water runs clear (approx. 3L). This will clean the water supply system and remove air from the lines.
- Additional flushing may be required in some households.
- Open the refrigerator door and make sure there are no water leaks coming from the water filter.

 A newly installed water filter cartridge may cause water to briefly spurt from the water dispenser. This is due to air getting into the line. It should pose no problem to operation.

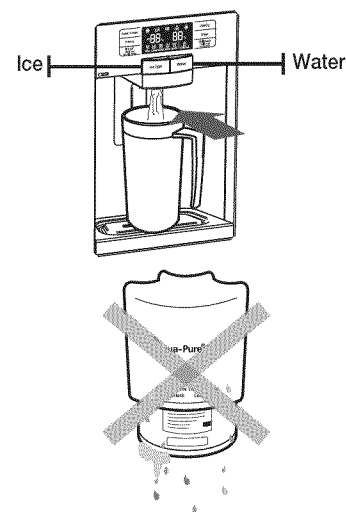

## Check the amount of water supplied to the ice tray.

- Lift up the icemaker cover and gently pull it out.
- When you press the Test button for 3 seconds, the ice cube container is filled with water from the water supply tap. Check to make sure the amount of water is correct(see the illustration below).

If the water level is too low, the ice cubes will be small. This is a water pressure problem from within the main water pipes, not the refrigerator.

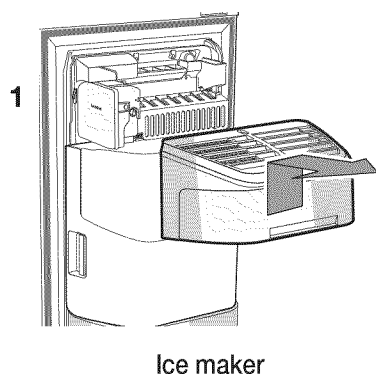

Ice maker

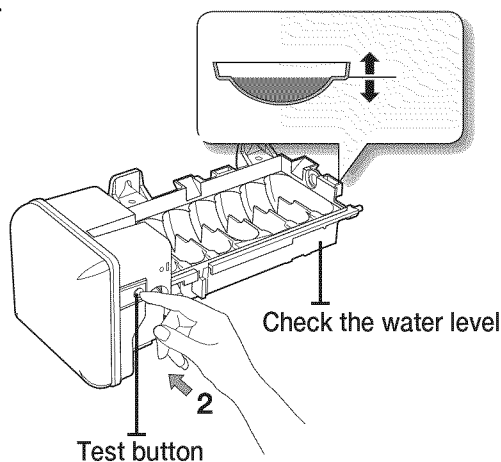

CAUTION

- It will take a few minutes to reach the amount of water you want.
- Do not press the test button continuously when the tray is filled with ice or water. Water may overflow or ice jamming may occur.
- When the bucket is not installed, the ice maker does not work.
- When ICE OFF blinks on the display panel, reinsert the bucket and/or make sure it's installed properly.

# operating the SAMSUNG side-by-side refrigerator

## Using the Control Panel / Digital Display

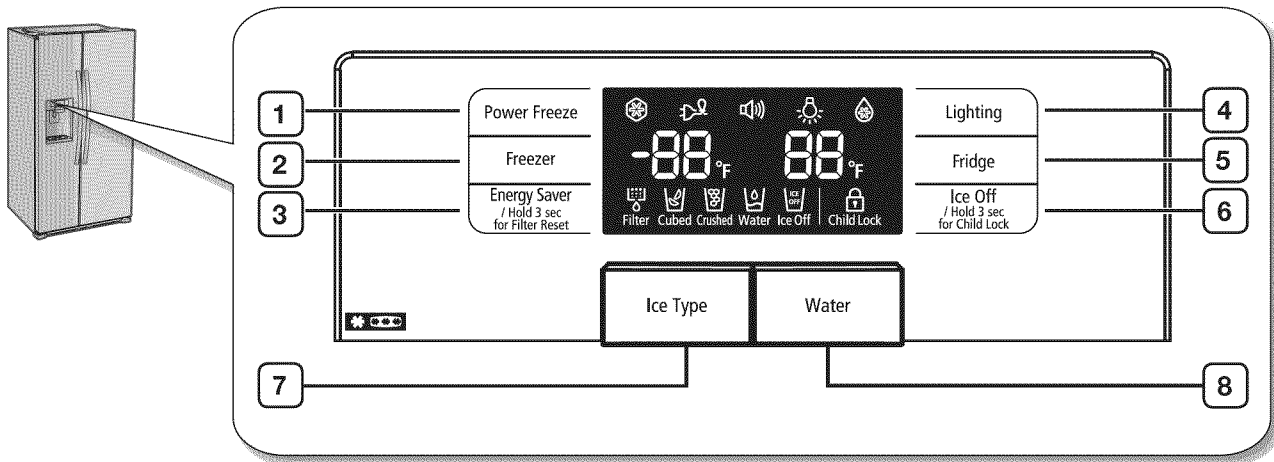

<p><b>1 Power Freeze Button</b></p>	<p>Speeds up the time needed to freeze products in the freezer. This can be helpful if you need to quickly freeze items that spoil easily or if the temperature in the freezer has warmed dramatically (For example, if the door was left open).</p>
<p><b>2 Freezer Button</b></p>	<p>Press the <b>Freezer</b> button to set the freezer to your desired temperature. You can set the temperature between 8°F and -14°F.</p>
<p><b>3 Energy Saver</b></p>	<p>For better energy efficiency, press the <b>Energy Saver</b> button. If condensation occurs on the doors, turn the Energy Saver Button function off.</p> <p>When you change the filter, press and hold this button for 3 seconds to reset the filter schedule.</p>
<p><b>4 Lighting Button</b></p>	<p>Press the <b>Lighting</b> button to turn on the dispenser LED lamp.</p>
<p><b>5 Fridge Button</b></p>	<p>Press the <b>Fridge</b> button to set the fridge to your desired temperature. You can set temperature between 34°F~46°F.</p> <p>Power cool will operate when the temperature is set lower than 34°F.</p>
<p><b>6 Ice Off Button</b></p>	<p>Press the Ice Off button to turn the ice making function off.</p> <p>If press and hold this button for 3 seconds, all buttons will be locked. The Ice Type button and the dispenser pad will not work either. To cancel this function, press and hold this button again.</p>
<p><b>7 Ice Type Button</b></p>	<p>Press the <b>Ice Type</b> button to choose cubed or crushed ice.</p>
<p><b>8 Water Button</b></p>	<p>Press the <b>Water</b> button for water.</p>

## USING THE DIGITAL DISPLAY

---

“Freezer Temp.” indicates the current Freezer temperature.

“Fridge Temp.” indicates the current Fridge temperature.

When not in use the Display will turn off, this is normal.

### Power Freeze

---

This icon will light up when you activate the “Power Freeze” feature. “Power Freeze” is great for times when you need a lot of ice. When you have enough, just press the button again to cancel the “Power Freeze” mode.

 When you use this function the energy consumption of the refrigerator will increase. Remember to turn it off when you don't need it and return the freezer to your original temperature setting.

### Energy Saver

---

This icon will light up when you activate the “Energy Saver” function. The Energy Saver function is automatically set to “ON” when power is supplied to the Refrigerator. If condensation occurs on the doors, turn the Energy Saver function off.

### Alarm

---

This icon will be lit all the time. The door alarm will sound if any door is open for more than 2 minutes. The beeping stops when you close the door. If you need to turn off the Alarm function, press the Lighting and Fridge buttons for 3 seconds at the same time.

### Lighting

---

This icon will light up when you activate the “Lighting” feature. In this case, the dispenser light (under the display) will be on constantly. If you would like the dispenser light to come on only when using the dispenser, turn the “Lighting” feature off by pressing the “Lighting” button..

### Power Cool

---

This icon will light up when you activate the “Power Cool” feature (refer to 5. Fridge Button on Page 18 to select this function). For a quick fridge cool down, use “Power Cool”. If you select “Power Cool”, the inside temperature of the Fridge will decrease for about two and a half hours.

### Filter Indicator

---

When the filter indicator light changed to red, it is time to change the filter. Typically this happens about every 6 months.

The filter Indicator will be Blue when you initially insert the water filter.

The filter Indicator will be purple when you have used your water filter for 5 months.

The filter Indicator will be Red when you have used your water filter for 6 months.

After removing the old water filter and installing a new one (see page 29 for instructions on how to do this), reset the indicator status light by pressing the Ice off button for about 3 seconds.

### Cubed Ice , Crushed Ice

---

Enjoy cubed or crushed ice by selecting your preference from the digital control panel. The ice type light indicates the type of ice that is currently chosen.

### Water

---

This icon will light up when you activate the “Water” feature.

## Ice Off

This icon will light up when you activate the “Ice Off” feature. In this case, the ice will not be produced. When ICE OFF blinks on the display panel, reinsert the bucket and/or make sure it’s installed properly.

## Child Lock

This icon will light up when you activate the “Lock” feature. In this case, you won’t be able to use the control panel. If you press and hold the Ice Off/Hold 3 sec for Child Lock Button you will be able to use the control panel again.

## Canceling Cooling Off Mode (“OF & OF” code on the display)

 This function is for store display. It is not for customer use.



In case of Cooling Off Mode, It seems working but doesn’t make cool air. To cancel this mode, press the Power Freeze and Freezer buttons at the same time for 3 seconds until “Ding-dong” sounds.

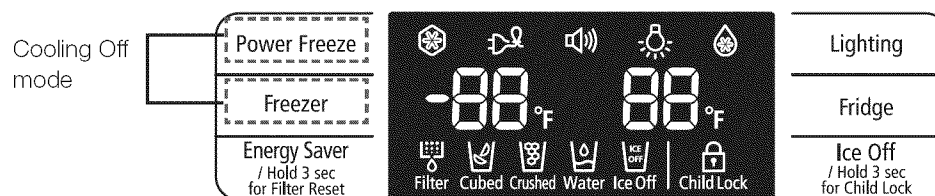

## CONTROLLING THE TEMPERATURE

### Basic Temperature of Freezer and Fridge

The basic and recommended temperature of Freezer and Fridge compartments are -4°F/38°F.

If the temperature of Freezer and Fridge compartments are too high or low, adjust the temperature manually.

### Controlling the Freezer temperature

The freezer temperature can be set between 8°F and -14°F to suit your particular needs. Press the **Freezer** button repeatedly until the desired temperature is shown in the temperature display. Keep in mind that foods like ice cream may melt at 4°F.

The temperature display will move sequentially from 8°F and -14°F. When the display reaches 8°F, it will begin again at -14°F.

Five seconds after the new temperature is set the display will again show the actual current freezer temperature. However, this number will change as the Freezer adjusts to the new temperature.

### Controlling the Fridge temperature

The refrigerator temperature can be set between 46°F and 34°F to suit your particular needs. Press the **Fridge** button repeatedly until the desired temperature is shown in the temperature display.

The temperature control process for the Fridge works just like the Freezer process.

Press the **Fridge** button to set your desired temperature. After a few seconds, the Fridge will begin tracking towards the newly set temperature. This will be reflected in the digital display.

-  - The temperature of the freezer or the refrigerator may rise from opening the doors too frequently, or if a large amount of warm or hot food is placed in either side.
- This may cause the digital display to blink. Once the freezer and refrigerator return to their normal set temperatures the blinking will stop.
  - If the blinking continues, you may need to “reset” the refrigerator. Try unplugging the appliance, wait about 10 minutes and then plug back in.

# operating the SAMSUNG side-by-side refrigerator

## USING THE ICE AND COLD WATER DISPENSER

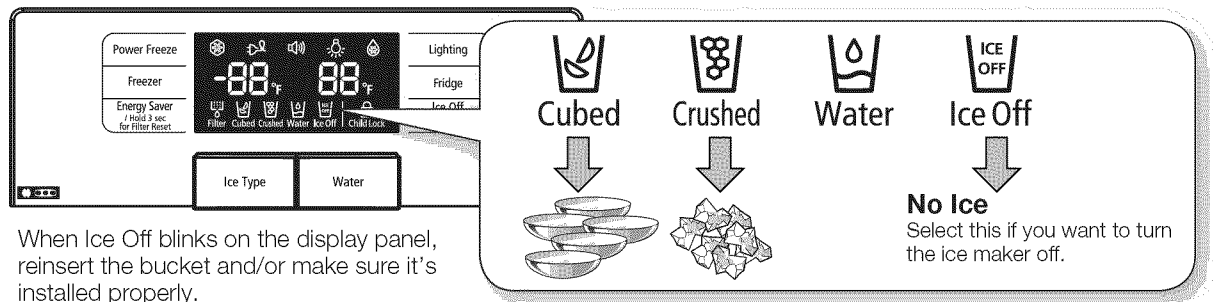

### Using the Water Dispenser

Press the Water button. Place your cup at the water outlet and push gently against the dispenser pad. Make sure the glass is in line with the dispenser to prevent the water from splashing out.

To get cooler water

- The dispensed water is cool, not icy cold
- When you want colder water with ice, dispense ice to your drink glass first before filling it with water to prevent water from splashing out.

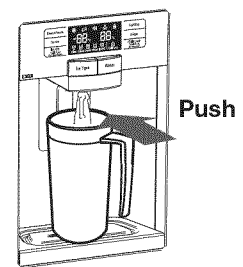

### Using the Ice Dispenser

Press the Ice Type button to select the type of ice you want. Place your cup under the ice outlet and push gently against the dispenser pad. Make sure the glass is in line with the dispenser to prevent the ice from bouncing out. When Cubed Ice is selected after using the Crushed Ice feature, a small amount of residual crushed ice might be produced.



- Do not put your fingers, hands or any other unsuitable objects in the chute or ice-maker bucket.
- It may result in personal injury or material damage.

- Use only the ice maker provided with the refrigerator.
- The water supply to this refrigerator must only be installed/connected by a suitably qualified person and connect to a potable water supply only.
- In order to operate the ice maker properly, water pressure of 20~125 psi is required.



- If you have a long vacation or business trip and won't use the water or ice dispensers, close the water valve.
- Otherwise, water leakage may occur.
- When you have not used the Ice maker for a while, or you have opened the Freezer door frequently, the Ice may stick together. If this has occurred, empty the ice container or break up the ice with a wood kitchen tool.
- Do not use sharp items such as knives or forks.
- When the bucket is removed, there may still be some residual ice in the ice maker that will be produced.



- In case ice doesn't come out, pull out the icemaker cover and press test button located on the ice maker.
- Do not press the test button continuously when the tray is filled with ice or water as illustration below. Water may overflow or ice jamming may occur

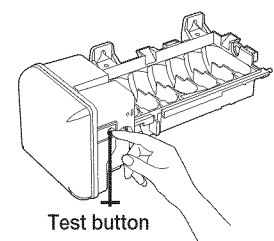
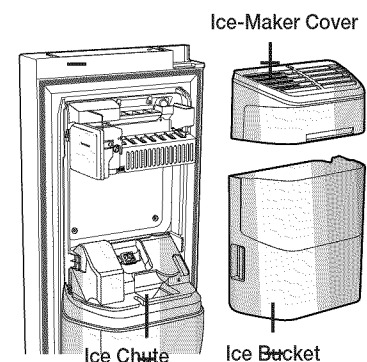

## STORING FOOD

The Samsung Side-By-Side Refrigerator has been designed to provide you with maximum space saving features and functions. Here are some of the customized compartments we have created to keep your food fresher, longer. Remember, in order to prevent odor penetration to the ice, stored food should be wrapped securely and as airtight as possible.





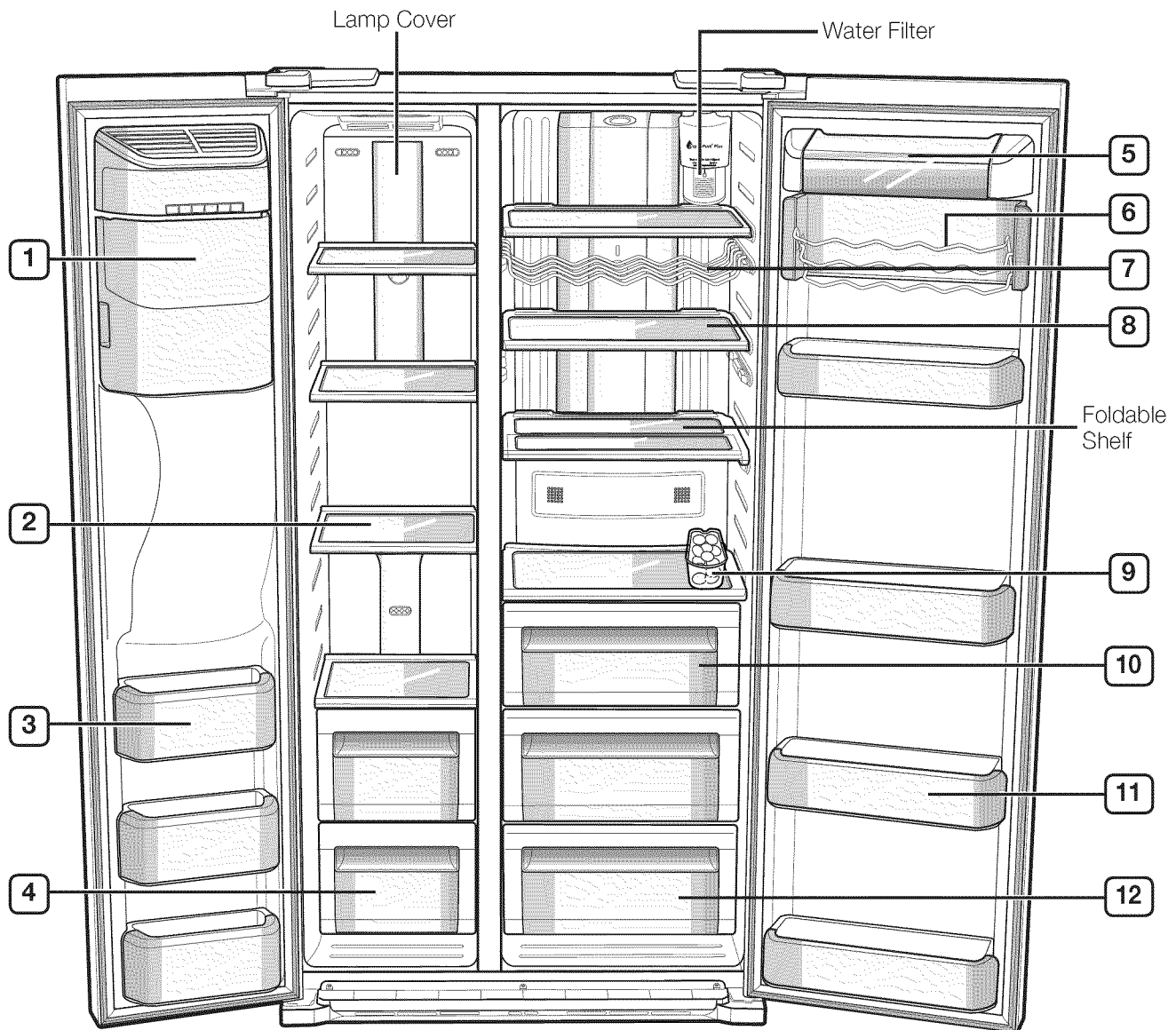

CAUTION



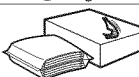

Because these following operating instructions cover various models, your refrigerator may differ from those described in this manual.

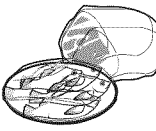

## Storing Food in the Freezer

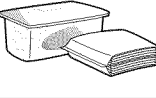
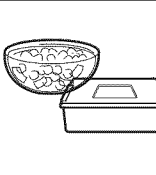
<b>1 Ice Maker Bucket</b>	<p>- Designed to store lots of ice easily.</p> <p> Do not put your fingers, hands or any other objects in the ice chute or the ice maker bucket. This may result in personal injury or material damage.</p> <p><b>WARNING</b></p>	
<b>2 Shelves</b>	<p>Can be used to store all types of frozen food.</p>	
<b>3 Door Bins</b>	<p>Can be used for small packages of frozen food.</p>	
<b>4 Drawers</b>	<p>Best used to store meats or dry foods. Stored food should be wrapped securely using foil or other suitable wrapping materials or containers.</p>	

## Storing Food in the Fridge

<b>5 Dairy Bin</b>	<p>Can be used to store smaller dairy items like butter or margarine, yogurt or cream-cheese bricks.</p>	
<b>6 Tilt Can Carry</b>	<p>Can be used to store beverage cans or bottles.</p>	
<b>7 Wine Rack (optional)</b>	<p>Helps wines maintain their taste by providing an optimized place for storing your wine bottles.</p>	
<b>8 Shelves</b>	<p>Designed to be crack-resistant. They can be used to store all types of food and drinks. Circular marks on the glass surface are a normal phenomenon and can usually be wiped clean with a damp cloth.</p>	
<b>9 Egg Container</b>	<p>Best place to keep eggs. Place the EGG TRAY on the shelf for easy access.</p>	
<b>10 Fresh Drawer</b>	<p>Helps to preserve the taste of food and prolongs its freshness. Use to store bread and cake.</p>	
<b>11 Door Bins</b>	<p>Designed to handle large, bulky items such as gallons of milk or other large bottles and containers.</p>	
<b>12 Fruit &amp; Vegetable Drawer</b>	<p>Used to preserve the freshness of your stored vegetables and fruits. It has been specifically designed to control the level of humidity within the drawer.</p>	

 Bottles should be stored tightly together so that they do not tip and fall out when the refrigerator door is opened.



- If you plan to go away for a significant time, empty the refrigerator and turn it off. Wipe the excess moisture from the inside of the appliance and leave the doors open. This helps keep odor and mold from developing.
- If the refrigerator is not to be used for a long period of time, pull out the power plug.
  - Deterioration in the power cord insulation may cause fire.

# operating the SAMSUNG side-by-side refrigerator

## REMOVING THE FREEZER/FRIDGE ACCESSORIES

Cleaning and rearranging the interior of the freezer is a snap.

### 1. Shelves (Freezer/Fridge)

Remove the shelf by pulling the shelf out to the hole point as shown at the right figure, then turn and lift it up.

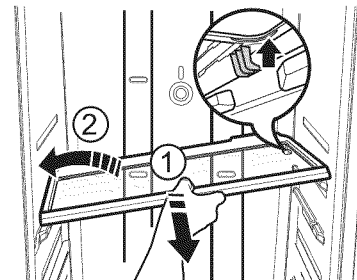

### 2. DOOR BIN

Remove the Door Bin by holding it with both hands and then gently lift it up.

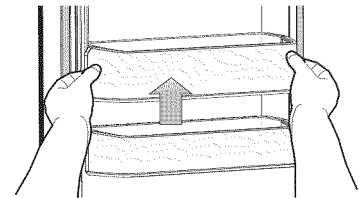

### 3. DRAWER

Remove the Drawer by pulling it out and slightly lifting it up.

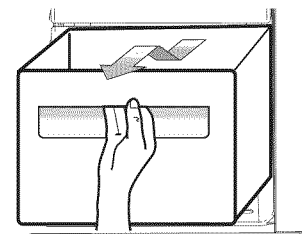

### 4. Drawer Cover

Remove all Drawers before removing the cover.  
Pull the cover out to the hole point, then turn and lift it up.

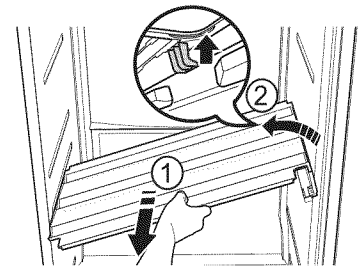



### 5. Ice Bucket (Freezer)

Remove the Icemaker Bucket by lifting up and pulling it out slowly.

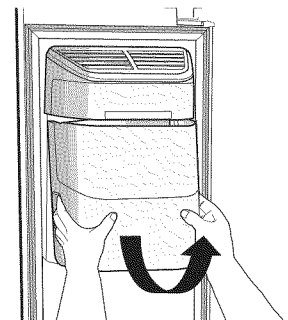
- Grip the handle as shown in the figure
- Lift the low part slightly
- Take the ice bucket out slowly



 Do not use excessive force when removing the drawer cover. Otherwise, the cover may break and cause injury.

 Before removing any accessories, make sure that no food is in the way. When possible, remove the food altogether to reduce the risk of accidents.

# CLEANING THE REFRIGERATOR

Caring for your Samsung Side-By-Side Refrigerator prolongs the life of your appliance and helps keep it odor and germ-free.

## Cleaning the Interior

Clean the inside walls and accessories with a mild detergent and then wipe dry with a soft cloth. You can remove the drawers and shelves for a more thorough cleaning. Just make sure to dry them before putting them back into place.

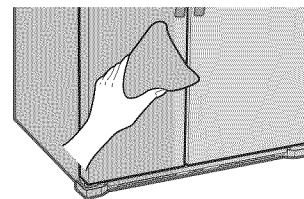

## Cleaning the Exterior

Wipe the digital panel and display panel with a clean, soft cloth. Spray water onto the cleaning cloth instead of spraying directly on the surface of the refrigerator. This helps ensure an even distribution of moisture to the surface. The doors, handles and cabinet surfaces should be cleaned with a mild detergent and then wiped dry with a soft cloth. To keep your appliance looking its best, the exterior should be polished once or twice a year.

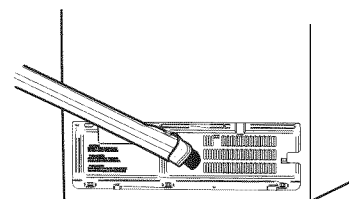

**WARNING** Do not use Benzene, Thinner or Clorox™ for cleaning. They may damage the surface of the appliance and can create a risk of fire.

## Cleaning the Rubber door seals

If the rubber door seals are dirty, the doors may not close properly, and the refrigerator will not operate efficiently. Keep the door seals free of grit or grime by cleaning the doors with a mild detergent and damp cloth. Wipe dry with a clean, soft cloth.

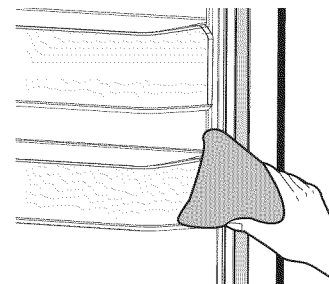

**CAUTION** Do not spray the refrigerator with water while it is plugged in, as it may cause an electric shock. Do not clean the refrigerator with benzene, thinner or car detergent as there is a risk of fire.

# operating the SAMSUNG side-by-side refrigerator

## CHANGING THE INTERIOR LIGHTS

 Pull the power plug out of the socket before changing the interior light of the refrigerator.  
- Otherwise, there is a risk of electric shock.  
**WARNING** If you experience difficulty when changing the light, contact your service center.

### Changing the LED Type Lighting

 Do not disassemble or replace the LED type Lighting.  
To change the LED Type Lighting, contact a Samsung service center.

## CHANGING THE WATER FILTER

The “Filter Indicator” light lets you know when it is time to change your water filter cartridge. To give you preparation time to get a new filter, the red light will come on just before the capacity of the current filter runs out. Changing the filter on time provides you with the freshest, cleanest water from your fridge.

-  1. Remove the water filter from the box and put a month indicator sticker on the filter as shown. Place a sticker on the filter that dates six months in the future. For example, if you are replacing the water filter in March, put the “SEP” (September) sticker on the filter to remind you to replace in September. Normal filter life is about every 6 months.
2. Remove the new filter’s protective cap and remove the old filter.
3. Position and insert the new filter into the filter housing.

Slowly turn the water filter clockwise to align with the printing mark on the cover, locking the filter in position. Make sure to align the water filter label mark with the center of cover filter printing as illustrated. Remember, do not over-tighten.

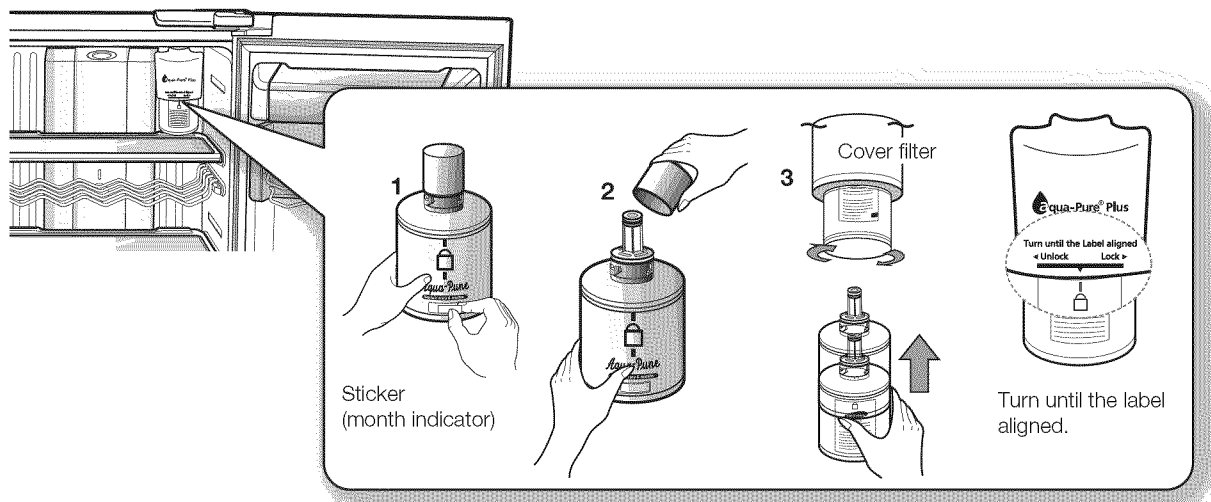

- Once you have completed this process, hold the Ice Off button simultaneously for 3 seconds to reset the filter schedule.



- Lastly, run about 0.8 gal. of water through water dispenser and throw away. Make sure that water flows clearly again before drinking.
- See installing the water filter instructions page 16.

 A newly installed water filter cartridge may cause water to briefly spurt from the water dispenser. This is due to air getting into the line. It should pose no problem to operation.

### Ordering replacement filters

To order more water filter cartridges, contact your authorized Samsung dealer.

## USING THE DOORS

The refrigerator doors are equipped with a door opening and closing feature that ensures that the doors close all the way and are securely sealed.

After opening beyond a certain point, the door will “catch” and remain open. When the door is ajar ahead of the catch that allows it to stay open, it will close automatically.

# BEFORE USING ICEMAKER

## Remove

- Hold the handle as shown in figure1.
- Slightly pull up the bottom part.
- Take out the ice bucket slowly.

## Install

- Assemble it in the reverse order of disassembly.
- Push the bucket in firmly until you hear a clicking sound.
- When the bucket does not fit into its place, turn the gear handle on its back by 90 degrees and reinstall it again as shown in figure 2.

## Before calling service

- Any sounds you hear when the ice maker dumps ice into the bucket are part of normal operation.
- Not dispensing ice for long periods may cause ice clumps in the ice bucket. Remove the remaining ice and empty the bucket.
- When ice does not come out, check the ice stuck in the chute and remove it.



- When ICE OFF blinks on the display panel, reinsert the bucket and/or make sure it's installed properly.
- When the door is open, the Ice and water dispenser do not work.
- If you close the door hard, it may cause water spilling over the ice maker.
- To prevent dropping the ice bucket, use both hands when removing it.
- To prevent injury, be sure to clean up any ice or water that may have dropped on the floor.
- Do not let the children hang on the ice dispenser or on the bucket. They may get hurt.
- Be sure not to put your hand or any object into the ice chute. It may cause personal injury or damage mechanical parts.

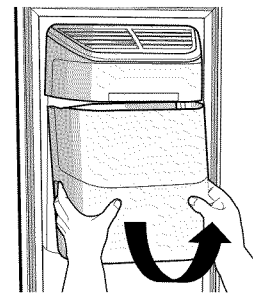

Figure1

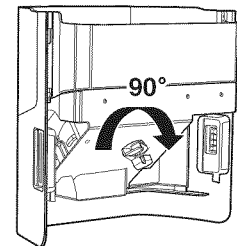
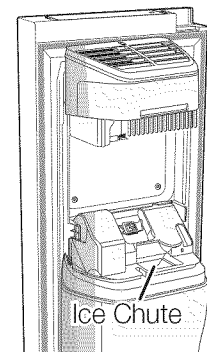

Figure2



# troubleshooting

PROBLEM	SOLUTION
The refrigerator does not work at all or it does not chill sufficiently.	<ul style="list-style-type: none"> <li>• Check that the power plug is properly connected.</li> <li>• Is the temperature control on the display panel set to the correct temperature? Try setting it to a lower temperature.</li> <li>• Is the refrigerator in direct sunlight or located too near a heat source?</li> <li>• Is the back of the refrigerator too close to the wall and therefore keeping air from circulating?</li> </ul>
The food in the fridge is frozen.	<ul style="list-style-type: none"> <li>• Is the temperature control on the display panel set to the correct temperature? Try setting it to a warmer temperature.</li> <li>• Is the temperature in the room very low?</li> <li>• Did you store the food with a high water content in the coldest part of the fridge?</li> </ul>
You hear unusual noises or sounds.	<ul style="list-style-type: none"> <li>• Check that the refrigerator is level and stable.</li> <li>• Is the back of the refrigerator too close to the wall and therefore keeping air from circulating?</li> <li>• Was anything dropped behind or under the refrigerator?</li> <li>• A “ticking” sound is heard from inside the refrigerator. This is normal and occurs because various accessories are contracting or expanding in relation to the temperature of the refrigerator interior.</li> </ul>
The front corners of the appliance are hot and condensation is occurring.	<ul style="list-style-type: none"> <li>• Some heat is normal as anti-condensators are installed in the front corners of the refrigerator to prevent condensation.</li> <li>• Is the refrigerator door ajar? Condensation can occur when you leave the door open for a long time.</li> </ul>
Ice is not dispensing.	<ul style="list-style-type: none"> <li>• Did you wait for 12 hours after installation of the water supply line before making ice?</li> <li>• Is the water line connected and the shut-off valve open?</li> <li>• Did you manually stop the ice making function? Make sure Ice Type is set to Cubed or Crushed.</li> <li>• Is there any ice blocked within the ice maker bucket?</li> <li>• Is the freezer temperature too warm? Try setting the freezer temperature lower.</li> </ul>
You can hear water bubbling in the refrigerator.	<ul style="list-style-type: none"> <li>• This is normal. The bubbling comes from the refrigerant coolant liquid circulating through the refrigerator.</li> </ul>
There is a bad smell in the refrigerator.	<ul style="list-style-type: none"> <li>• Has a food item spoiled?</li> <li>• Make sure that strong smelling food (for example, fish) is wrapped so that it is airtight.</li> <li>• Clean out your freezer periodically and throw away any spoiled or suspect food.</li> </ul>
Frost forms on the walls of the freezer.	<ul style="list-style-type: none"> <li>• Is the air vent blocked? Remove any obstructions so air can circulate freely.</li> <li>• Allow sufficient space between the foods stored for efficient air circulation.</li> <li>• Is the freezer door closed properly?</li> </ul>
Water dispenser is not functioning.	<ul style="list-style-type: none"> <li>• Is the water line connected and the shut-off valve open?</li> <li>• Has the water supply line tubing been crushed or kinked? Make sure the tubing is free and clear of any obstruction.</li> <li>• Is the water tank frozen because the refrigerator temperature is too low? Try selecting a warmer setting on the main display panel.</li> </ul>

# Warranty

---

## **SAMSUNG REFRIGERATOR (24.1 CUBIC FEET AND LARGER CAPACITY)**

---

### LIMITED WARRANTY TO ORIGINAL PURCHASER

This Samsung brand product, as supplied and distributed by Samsung Electronics America, Inc. (Samsung) and delivered new, in the original carton to the original consumer purchaser, is warranted by Samsung against manufacturing defects in materials and workmanship for a limited warranty period of:

**one (1) year Parts and Labor on Refrigerator**

**Five (5) years Parts and Labor on sealed Refrigeration system only\***

(\*Compressor, evaporator, condenser, drier, connecting tubing)

This limited warranty begins on the original date of purchase, and is valid only on products purchased and used in the United States. To receive warranty service, the purchaser must contact Samsung for problem determination and service procedures. Warranty service can only be performed by a Samsung authorized service center. The original dated bill of sale must be presented upon request as proof of purchase to Samsung or Samsung authorized service center.

Samsung will repair or replace any part found to be defective, at our option and at no charge as stipulatedX herein, with new or reconditioned parts during the limited warranty period specified above. All replaced parts and products become the property of Samsung and must be returned to Samsung. Replacement parts and products assume the remaining original warranty, or ninety (90) days, whichever is longer.

In-home service will be provided during the warranty labor period subject to availability within the contiguous United States. In-home service is not available in all areas. To receive in-home service, the product must be unobstructed and accessible from floor level to service personnel. If during in-home service repair cannot be completed, it may be necessary to remove, repair and return the product. If in-home service is unavailable, Samsung may elect, at our option, to provide for transportation of our choice to and from a Samsung authorized service center. Otherwise, transportation to and from the Samsung authorized service center is the responsibility of the purchaser.

This limited warranty covers manufacturing defects in materials and workmanship encountered in normal, noncommercial use of this product, and shall not apply to the following, including, but not limited to: damage which occurs in shipment; delivery and installation; applications and uses for which this product was not intended; altered product or serial numbers; cosmetic damage or exterior finish; accidents, abuse, neglect, fire, water, lightning or other acts of nature; use of products, equipment, systems, utilities, services, parts, supplies, accessories, applications, installations, repairs, external plumbing and leaks, external wiring, circuit breakers, fuses or connectors not supplied and authorized by Samsung, or which damage this product or result in service problems; incorrect electrical line voltage, fluctuations and surges; customer adjustments and failure to follow operating instructions, cleaning, maintenance and environmental instructions that are covered and prescribed in the instruction book; loss of food due to spoilage; consumable items including filters and light bulbs.

THERE ARE NO EXPRESS WARRANTIES OTHER THAN THOSE LISTED AND DESCRIBED ABOVE, AND NO WARRANTIES WHETHER EXPRESS OR IMPLIED, INCLUDING, BUT NOT LIMITED TO, ANY IMPLIED WARRANTIES OF MERCHANTABILITY OR FITNESS FOR A PARTICULAR PURPOSE, SHALL APPLY AFTER THE EXPRESS WARRANTY PERIODS STATED ABOVE, AND NO OTHER EXPRESS WARRANTY OR GUARANTY GIVEN BY ANY PERSON, FIRM OR CORPORATION WITH RESPECT TO THIS PRODUCT SHALL BE BINDING ON SAMSUNG. SAMSUNG SHALL NOT BE LIABLE FOR LOSS OF REVENUE OR PROFITS, FAILURE TO REALIZE SAVINGS OR OTHER BENEFITS, OR ANY OTHER SPECIAL, INCIDENTAL OR CONSEQUENTIAL DAMAGES CAUSED BY THE USE, MISUSE OR INABILITY TO USE THIS PRODUCT, REGARDLESS OF THE LEGAL THEORY ON WHICH THE CLAIM IS BASED, AND EVEN IF SAMSUNG HAS BEEN ADVISED OF THE POSSIBILITY OF SUCH DAMAGES. NOR SHALL RECOVERY OF ANY KIND AGAINST SAMSUNG BE GREATER IN AMOUNT THAN THE PURCHASE PRICE OF THE PRODUCT SOLD BY SAMSUNG AND CAUSING THE ALLEGED DAMAGE. WITHOUT LIMITING THE FOREGOING, PURCHASER ASSUMES ALL RISK AND LIABILITY FOR LOSS, DAMAGE OR INJURY TO PURCHASER AND PURCHASER'S PROPERTY AND TO OTHERS AND THEIR PROPERTY ARISING OUT OF THE USE, MISUSE OR INABILITY TO USE THIS PRODUCT SOLD BY SAMSUNG NOT CAUSED DIRECTLY BY THE NEGLIGENCE OF SAMSUNG. THIS LIMITED WARRANTY SHALL NOT EXTEND TO ANYONE OTHER THAN THE ORIGINAL PURCHASER OF THIS PRODUCT, IS NONTRANSFERABLE AND STATES YOUR EXCLUSIVE REMEDY.

Some states do not allow limitations on how long an implied warranty lasts, or the exclusion or limitation of incidental or consequential damages, so the above limitations or exclusions may not apply to you. This warranty gives you specific legal rights, and you may also have other rights, which vary from state to state.

To obtain warranty service, please contact Samsung at:

**SAMSUNG CUSTOMER CARE CENTER**

Samsung Electronics America, Inc. 400 Valley Road Suite 201 Mt. Arlington, NJ 07956  
1-800-sAMsunG (1-800-726-7864) and [www.samsung.com](http://www.samsung.com)



## QUESTIONS OR COMMENTS?

COUNTRY	CALL	OR VISIT US ONLINE AT	WRITE
U.S	800-SAMSUNG (800-726-7864)	<a href="http://www.samsung.com">www.samsung.com</a>	Samsung Electronics America, Inc. 400 Valley Road Suite 201 Mt. Arlington, NJ 07956
CANADA	800-SAMSUNG (800-726-7864)	<a href="http://www.samsung.com/ca">www.samsung.com/ca</a>	Samsung Electronics Canada Inc. Customer Service, 55 Standish Court Mississauga, Ontario L5R 4B2 Canada

Code No. DA99-01746A REV(0.0)