



WD10J8\*\*\*\*\*

# Washing Machine

## User manual

Imagine the possibilities

Thank you for purchasing this Samsung product.

**SAMSUNG**

# Content

<b>Safety information</b>	<b>3</b>
What you need to know about the safety instructions . . . . .	3
Important safety symbols . . . . .	3
Important safety precautions . . . . .	4
<b>Installation</b>	<b>13</b>
What's included . . . . .	13
Installation requirements . . . . .	14
Step-by-step installation . . . . .	16
Environment . . . . .	20
Screw cover . . . . .	20
<b>Before you start</b>	<b>21</b>
Initial settings . . . . .	21
Laundry guidelines . . . . .	22
Detergent drawer guidelines . . . . .	24
<b>Operations</b>	<b>26</b>
Control panel . . . . .	26
Simple steps to start . . . . .	27
Course overview . . . . .	29
Settings (*  ). . . . .	33
<b>Maintenance</b>	<b>35</b>
Drum clean. . . . .	35
Smart check. . . . .	36
Emergency drain . . . . .	37
Cleaning. . . . .	38
Recovery from freezing. . . . .	41
Care against an extended time of disuse . . . . .	41
<b>Troubleshooting</b>	<b>42</b>
Checkpoints. . . . .	42
Information codes . . . . .	43
<b>Specifications</b>	<b>44</b>
Protecting the environment. . . . .	44
Fabric care chart . . . . .	45
Specification sheet . . . . .	46

# Safety information

Congratulations on your new Samsung washing machine. This manual contains important information on the installation, use and care of your appliance. Please take some time to read this manual to take full advantage of your washing machine's many benefits and features.

## What you need to know about the safety instructions





Please read this manual thoroughly to ensure that you know how to safely and efficiently operate the extensive features and functions of your new appliance. Please store the manual in a safe location close to the appliance for future reference. Use this appliance only for its intended purpose as described in this instruction manual.

Warnings and Important Safety Instructions in this manual do not cover all possible conditions and situations that may occur. It is your responsibility to use common sense, caution and care when installing, maintaining and operating your washing machine.

Because the following operating instructions cover various models, the characteristics of your washing machine may differ slightly from those described in this manual and not all warning signs may be applicable. If you have any questions or concerns, contact your nearest service centre or find help and information online at [www.samsung.com](http://www.samsung.com).

## Important safety symbols

What the icons and signs in this user manual mean:

	<b>WARNING:</b> Hazards or unsafe practices that may result in <b>severe personal injury, death and/or property damage.</b>
	<b>CAUTION:</b> Hazards or unsafe practices that may result in <b>personal injury and/or property damage.</b>
	<b>CAUTION:</b> To reduce the risk of fire or explosion, follow these basic precautions.
	<b>NOTE</b>

**These warning signs are here to prevent injury to yourself and others.**

**Please follow them explicitly.**

**After reading this manual, store it in a safe place for future reference.**

Read all instructions before using the appliance.

As with any equipment that uses electricity and moving parts, potential hazards exist. To safely operate this appliance, familiarize yourself with its operation and exercise care when using it.

## Important safety precautions

---



**WARNING:** To reduce the risk of fire, electric shock, or injury to persons when using your appliance, follow basic precautions, including the following:

Do not let children (or pets) play in or on your product. The product door does not open easily from the inside and children may be seriously injured if trapped inside.

This appliance is not to be used by persons (including children) with reduced physical, sensory or mental capabilities, or lack of experience and knowledge, unless they have been given supervision or instruction concerning use of the appliance by a person responsible for their safety.

Children should be supervised to ensure that they do not play with the appliance.

**For use in Europe:** This appliance can be used by children aged from 8 years and above and persons with reduced physical, sensory or mental capabilities or lack of experience and knowledge if they have been given supervision or instruction concerning use of the appliance in a safe way and understand the hazards involved. Children shall not play with the appliance. Cleaning and user maintenance shall not be made by children without supervision.

If the supply cord is damaged, it must be replaced by the manufacturer, its service agent or similarly qualified persons in order to avoid a hazard.

This appliance should be positioned so that the power plug, the water supply taps, and the drain pipes are accessible.

For appliances with ventilation openings in the base, that a carpet must not obstruct the openings.

The new hose-sets supplied with the appliance are to be used and that old hose-sets should not be reused.

**CAUTION:** In order to avoid a hazard due to inadvertent resetting of the thermal cut-out, this appliance must not be supplied through an external switching device, such as a timer, or connected to a circuit that is regularly switched on and off by the utility.

The tumble dryer is not to be used if industrial chemicals have been used for cleaning.

The lint trap has to be cleaned frequently, if applicable.

Lint must not to be allowed to accumulate around the tumble dryer. (not applicable for appliances intended to be vented to the exterior of the building)

Adequate ventilation has to be provided to avoid the back flow of gases into the room from appliances burning other fuels, including open fires.

Do not dry unwashed items in the tumble dryer.

Items that have been soiled with substances such as cooking oil, acetone, alcohol, petrol, kerosene, spot removers, turpentine, waxes and wax removers should be washed in hot water with an extra amount of detergent before being dried in the tumble dryer.

Items such as foam rubber (latex foam), shower caps, waterproof textiles, rubber backed articles and clothes or pillows fitted with foam rubber pads should not be dried in the tumble dryer.

Fabric softeners, or similar products, should be used as specified by the fabric softener instructions.

The final part of a tumble dryer cycle occurs without heat (cool down cycle) to ensure that the items are left at a temperature that ensures that the items will not be damaged.

Remove all objects from pockets such as lighters and matches.

**WARNING:** Never stop a tumble dryer before the end of the drying cycle unless all items are quickly removed and spread out so that the heat is dissipated.

Exhaust air must not be discharged into a flue which is used for exhausting fumes from appliances burning gas or other fuels.

The appliance must not be installed behind a lockable door, a sliding door or a door with a hinge on the opposite side to that of the tumble dryer, in such a way that a full opening of the tumble dryer door is restricted.

**For use in Europe:** Children of less than 3 years should be kept away unless continuously supervised.



**CAUTION:** To minimize the risk of fire in a tumble dryer, the following should be observed:

Items that have been spotted or soaked with vegetable or cooking oil constitute a fire hazard and should not be placed in a tumble dryer. Oil-affected items can ignite spontaneously, especially when exposed to heat sources such as in a tumble dryer. The items become warm, causing an oxidation reaction in the oil. Oxidation creates heat. If the heat cannot escape, the items can become hot enough to catch fire. Piling, stacking or storing oil-affected items can prevent heat from escaping and so create a fire hazard. If it is unavoidable that fabrics that contain vegetable or cooking oil or have been contaminated by hair care products be placed in a tumble dryer they should first be washed in hot water with extra detergent – this will reduce, but not eliminate, the hazard. The ‘cool down’ cycle of tumble dryers should be used to reduce the temperature of the items. They should not be removed from the tumble dryer or piled or stacked while hot.

Items that have been previously cleaned in, washed in, soaked in or spotted with petrol/gasoline, dry-cleaning solvents or other flammable or explosive substances should not be placed in a tumble dryer. Highly flammable substances commonly used in domestic environments include acetone, denatured alcohol, petrol/gasoline, kerosene, spot removers(some brands), turpentine, waxes and wax removers.

Items containing foam rubber(also known as latex foam) or similarly textured rubber. Like materials should not be dried in a tumble dryer on a heat setting. Foam rubber materials can, when heated, produce fire by spontaneous combustion.

Fabric softeners or similar products should not be used in a tumble dryer to eliminate the effects of static electricity unless this practice is specifically recommended by the manufacturer of the fabric softener or product.

Undergarments that contain metal reinforcements should not be placed in a tumble dryer. Damage to the tumble dryer can result if metal reinforcements come loose during drying. When available a drying rack could be used for such items.

Plastic articles such as shower caps or babies’ waterproof napkin covers should not be placed in a tumble dryer.

Rubber-backed articles, clothes fitted with foam rubber pads, pillows, galoshes and rubber-coated

tennis shoes should not be placed in a tumble dryer.

**⚠ WARNING:** Do not dry unwashed items in the tumble dryer(or washing machine drying mode,etc).

Items that have been soiled with substances such as cooking oil, acetone, alcohol, petrol, Kerosene, spot removers, turpentine, waxes and wax removers should be washed in hot water with an extra amount of detergent before being dried in the tumble dryer.

Items such as foam rubber(latex foam), shower caps, waterproof textiles, rubber backed articles and clothes or pillows fitted with foam rubber pads should not be dried in the tumble dryer.

Fabric softeners, or similar products, should be used as specified by the fabric softener instructions. The final part of a tumble dryer cycle occurs without heat(cool down cycle) to ensure that the items are left at a temperature that ensures that the items will not be damaged.

Oil-affected items can ignite spontaneously, especially when exposed to heat sources such as in a tumble dryer. The items become warm, causing an oxidation reaction in the oil. Oxidation creates heat. If the heat cannot escape, the items can become hot enough to catch fire. Piling, stacking or storing oil-affected items can prevent heat from escaping and so create a fire hazard.

If it is unavoidable that fabrics that contain vegetable or cooking oil or have been contaminated by hair care products be placed in a tumble dryer they should first be washed in hot water with extra detergent - this will reduce, but not eliminate, the hazard.

**⚠ CAUTION:** Never stop a tumble dryer before the end of the drying cycle unless all items are quickly removed and spread out so that the heat is dissipated.

Remove all objects from pockets such as lighters and matches.

## **⚠ WARNING: Critical installation WARNINGS**

The installation of this appliance must be performed by a qualified technician or service company.

- Failure to do so may result in electric shock, fire, an explosion, problems with the product, or injury.

The appliance is heavy, therefore take care when lifting it.

Plug the power cord into an AC 220 - 240 V / 50 Hz wall socket or higher and use the socket for this appliance only. Never use an extension cord.

- Sharing a wall socket with other appliances using a power strip or extending the power cord may result in electric shock or fire.
- Ensure that the power voltage, frequency, and current are the same as those of the product specifications. Failure to do so may result in electric shock or fire. Plug the power plug into the wall socket firmly.

Remove all foreign substances such as dust or water from the power plug terminals and contact points using a dry cloth on a regular basis.

- Unplug the power plug and clean it with a dry cloth.
- Failure to do so may result in electric shock or fire.

Plug the power plug into the wall socket so that the cord is running towards the floor.

- If you plug the power plug into the socket in the opposite direction, the electric wires within the cable may be damaged and this may result in electric shock or fire.

Keep all packaging materials out of the reach of children as these may be dangerous.

- If a child places a bag over its head, it may suffocate.

When the appliance, power plug or power cord is damaged, contact your nearest service centre.

This appliance must be properly grounded.

Do not ground the appliance to a gas pipe, plastic water pipe, or telephone line.

- This may result in electric shock, fire, an explosion, or problems with the product.
- Never plug the power cord into a socket that is not grounded correctly and make sure that it is in accordance with local and national regulations.

Do not install this appliance near a heater or any inflammable material.

Do not install this appliance in a humid, oily or dusty location, or in a location exposed to direct sunlight or water (rain drops).

Do not install this appliance in a location exposed to low temperatures.

- Frost may cause the tubes to burst.

Do not install this appliance in a location where gas may leak.

- This may result in electric shock or fire.

Do not use an electric transformer.

- This may result in electric shock or fire.

Do not use a damaged power plug, damaged power cord, or loose wall socket.

- This may result in electric shock or fire.

Do not pull or excessively bend the power cord.

Do not twist or tie the power cord.

Do not hook the power cord over a metal object, place a heavy object on the power cord, insert the power cord between objects, or push the power cord into the space behind the appliance.

- This may result in electric shock or fire.

Do not pull the power cord when unplugging the power plug.

- Unplug the power plug by holding the plug.
- Failure to do so may result in electric shock or fire.

## **CAUTION: Installation CAUTIONS**

This appliance should be positioned in such a way that the power plug is easily accessible.

- Failure to do so may result in electric shock or fire due to electric leakage.

Install your appliance on a solid, level floor that can support its weight.

- Failure to do so may result in abnormal vibrations, movement, noise, or problems with the product.

## **⚠ WARNING: Critical usage WARNINGS**

If the appliance is flooded, turn off the water & power supplies immediately and contact your nearest service centre.

- Do not touch the power plug with wet hands.
- Failure to do so may result in electric shock.

If the appliance generates a strange noise, a burning smell, or smoke, unplug the power plug immediately and contact your nearest service centre.

- Failure to do so may result in electric shock or fire.

In the event of a gas leak (such as propane gas, LP gas, etc.), ventilate immediately without touching the power plug. Do not touch the appliance or power cord.

- Do not use a ventilating fan.
- A spark may result in an explosion or fire.

Do not let children play in or on the washing machine. In addition, when disposing of the appliance, remove the washing machine door lever.

- If trapped inside the product, children may suffocate to death.

Make sure to remove the packaging (sponge, styrofoam) attached to the bottom of the washing machine before using it.

Do not wash items contaminated with gasoline, kerosene, benzene, paint thinner, alcohol or other inflammable or explosive substances.

- This may result in electric shock, fire, or an explosion.

Do not open the washing machine door by force while it is operating (high-temperature washing/drying/spinning).

- Water flowing out of the washing machine may result in burns or cause the floor to be slippery. This may result in injury.
- Opening the door by force may result in damage to the product or injury.

Do not insert your hand under the washing machine while an operation is in progress.

- This may result in injury.

Do not touch the power plug with wet hands.

- This may result in electric shock.

Do not turn the appliance off by unplugging the power plug while an operation is in progress.

- Plugging the power plug into the wall socket again may cause a spark and result in electric shock or fire.

Do not let children or the infirm use this washing machine without proper supervision. Do not let children climb in or onto the appliance.

- This may result in electric shock, burns or injury.

Do not insert your hand or a metal object under the washing machine while it is operating.

- This may result in injury.

Do not unplug the appliance by pulling the power cord. Always grip the plug firmly and pull it straight out of the outlet.

- Damage to the power cord may cause a short-circuit, fire and/or electric shock.

Do not attempt to repair, disassemble, or modify the appliance yourself.

- Do not use a fuse (such as copper, steel wire, etc.) other than a standard fuse.
- When the appliance needs to be repaired or reinstalled, contact your nearest service centre.
- Failure to do so may result in electric shock, fire, problems with the product, or injury.

If the water supply hose comes loose from the water tap and floods the appliance, unplug the power plug.

- Failure to do so may result in electric shock or fire.

Unplug the power plug when the appliance is not being used for long periods of time or during a thunder or lightning storm.

- Failure to do so may result in electric shock or fire.

If any foreign substance enters into the appliance, unplug the power plug and contact your nearest Samsung Customer Service.

- This may result in electric shock or fire.

## **CAUTION: Usage CAUTIONS**

When the washing machine is contaminated by a foreign substance such as detergent, dirt, food waste, etc., unplug the power plug and clean the washing machine using a damp, soft cloth.

- Failure to do so may result in discolouration, deformation, damage, or rust.

The front glass may be broken by a strong impact. Take care when using the washing machine.

- If the glass is broken, it may result in injury.

After a water supply failure or when reconnecting the water supply hose, open the water tap slowly.

Open the water tap slowly after a long period of non-use.

- The air pressure in the water supply hose or the water pipe may damage a product part or result in a water leak.

If a draining error occurs during an operation, check if there is a draining problem.

- If the washing machine is used when it is flooded because of a draining problem, it may result in electric shock or fire.

Insert the laundry into the washing machine completely so that the laundry does not get caught in the door.

- If laundry gets caught in the door, it may result in damage to the laundry or the washing machine, or result in a water leak.

Turn the water supply off when the washing machine is not being used.

Ensure that the screws on the water supply hose connector are properly tightened.

- Failure to do so may result in property damage or injury.

Ensure that the rubber seal and front door glass are not contaminated by a foreign substance (e.g. waste, thread, hair, etc.).

- If a foreign substance is caught in the door or the door is not completely closed, it may cause a water leak.

Open the water tap and check if the water supply hose connector is firmly tightened and that there is no water leak before using the product.

- If the screws on the water supply hose connector are loose, it may result in a water leak.

The product you have purchased is designed for domestic use only.

Using the product for business purposes qualifies as a product misuse. In this case, the product will not be covered by the standard warranty provided by Samsung and no responsibility can be attributed to Samsung for malfunctions or damages resulting from such misuse.

Do not stand on the appliance or place objects (such as laundry, lighted candles, lighted cigarettes, dishes, chemicals, metal objects, etc.) on the appliance.

- This may result in electric shock, fire, problems with the product, or injury.

Do not spray volatile material such as insecticide onto the surface of the appliance.

- As well as being harmful to humans, this may result in electric shock, fire or problems with the product.

Do not place objects that generate electromagnetic fields near the washing machine.

- This may result in injury due to a malfunction.

Water drained during a high-temperature wash or drying cycle is hot. Do not touch the water.

- This may result in burns or injury.

Do not wash, spin, or dry water-proof seats, mats, or clothing (\*) unless your appliance has a special cycle for washing these items.

(\*): Woollen bedding, rain covers, fishing vests, ski pants, sleeping bags, diaper covers, sweat suits, and bicycle, motor cycle and car covers, etc.

- Do not wash thick or hard mats even if the washing machine mark is on the care label. This may result in injury or damage to the washing machine, walls, floor, or clothing due to abnormal vibrations.
- Do not wash throw rugs or doormats with rubber backing. The rubber backing may come off and stick to inside the drum, and this may result in malfunction such as a drainage error.

Do not operate the washing machine when the detergent drawer is removed.

- This may result in electric shock or injury due to a water leak.

Do not touch the insides of the drum during or just after drying as it is hot.

- This may result in burns.

Do not insert your hand into the detergent drawer.

- This may result in injury as your hand may be caught by the detergent input device.

Do not place any objects (such as shoes, food waste, animals) other than laundry into the washing machine.

- This may result in damage to the washing machine, or injury and death in the case of pets due to the abnormal vibrations.

Do not press the buttons using sharp objects such as pins, knives, fingernails, etc.

- This may result in electric shock or injury.

Do not wash laundry contaminated by oils, creams or lotions usually found in skincare shops or massage clinics.

- This may cause the rubber seal to become deformed and result in a water leak.

Do not leave metal objects such as safety pins, hair pins or bleach in the drum for long periods of time.

- This may cause the drum to rust.

- If rust starts appearing on the surface of the drum, apply a (neutral) cleansing agent to the surface and use a sponge to clean it. Never use a metal brush.

Do not use dry cleaning detergent directly and do not wash, rinse, or spin laundry contaminated by dry cleaning detergent.

- This may result in spontaneous combustion or ignition due to the heat from the oxidation of the oil.

Do not use water from water cooling/heating devices.

- This may result in problems with the washing machine.

Do not use natural hand-washing soap for the washing machine.

- If it hardens and accumulates inside the washing machine, it may result in problems with the product, discolouration, rust, or bad odours.

Place socks and brassieres in a washing net and wash them with the other laundry.

Do not wash large laundry items such as bedding in the washing net.

- Failure to do so may result in injury due to abnormal vibrations.

Do not use hardened detergent.

- If it accumulates inside the washing machine, it may result in a water leak.

Make sure that the pockets of all the clothing items to be washed are empty.

- Hard, sharp objects such as coins, safety pins, nails, screws, or stones can cause extensive damage to the appliance.

Do not wash clothing with large buckles, buttons or other heavy metal objects.

Sort the laundry by color on the basis of its colorfastness and select the recommended cycle, water temperature and additional functions.

- This may result in discoloration or fabric damage.

Take care that children's fingers are not caught in the door when you close it.

- Failure to do so may result in injury.

## **WARNING: Critical cleaning WARNINGS**

Do not clean the appliance by spraying water directly onto it.

Do not use the a strong acidic cleaning agent.

Do not use benzene, thinner or alcohol to clean the appliance.

- This may result in discolouration, deformation, damage, electric shock or fire.

Before cleaning or performing maintenance, unplug the appliance from the wall socket.

- Failure to do so may result in electric shock or fire.

# Installation

Follow these instructions carefully to ensure proper installation of the washing machine and to help prevent accidents when doing laundry.

## What's included

Make sure all the parts are included in the product package. If you have a problem with the washing machine or the parts, contact a local Samsung customer centre or the retailer.

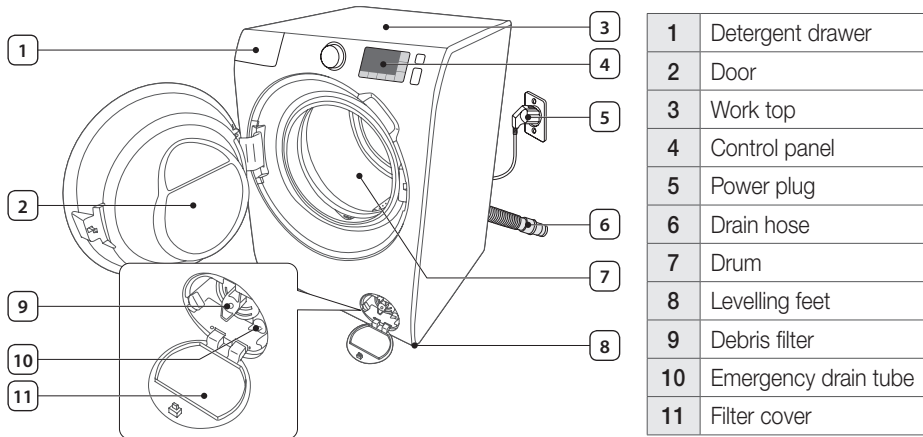

Spanner



Bolt caps

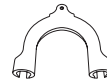

Hose guide



Cold water supply hose



Hot water supply hose

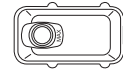

Liquid detergent container



**Bolt caps** : The provided number (3 to 6) of bolt caps depends on the model.

**Hot water supply hose**: Applicable models only.

**Liquid detergent container**: Applicable models only.

# Installation requirements

---

## Electrical supply and grounding

- AC 220-240 V / 50 Hz fuse or circuit breaker is required
- Use an individual branch circuit specific to the washing machine

To ensure proper grounding, the washing machine comes with a power cord featuring a three-prong grounding plug for use in a properly installed and grounded outlet.

Check with a qualified electrician or serviceperson if you are not sure about the grounding.

Do not modify the provided plug. If it does not fit the outlet, call a qualified electrician to install a proper outlet.



### **WARNING**

- Do NOT use an extension cord.
- Use only the power cord that comes with the washing machine.
- Do NOT connect the ground wire to plastic plumbing, gas lines, or hot water pipes.
- Improperly connected grounding conductors may cause electric shock.

## Water supply

A proper water pressure for this washing machine is between 50 kPa and 800 kPa. Water pressure less than 50 kPa may cause the water valve not to close completely. Or, it may take longer to fill the drum, causing the washing machine to turn off. Water taps must be within 120 cm from the rear of the washing machine so that the provided inlet hoses reach the washing machine.

To reduce the risk of leaks

- Make sure water taps are easily accessible.
- Turn off the taps when the washing machine is not in use.
- Check for any leaks at the water inlet hose fittings on a regular basis.



### **CAUTION**

Before using the washing machine for the first time, check all connections at the water valve and taps for any leaks.

## Drain

Samsung recommends a standpipe in height of 60~90 cm. The drain hose must be connected through the hose clip to the standpipe, and the standpipe must fully cover the drain hose.

## Flooring

For proper performance, the washing machine must be installed on a solid floor. Wood floors may need to be reinforced to minimize vibration and/or unbalanced loads. Carpeting and soft tile surfaces are not a good resistance to vibrations and may cause the washing machine to move slightly during the spin cycle.



### CAUTION

Do NOT install the washing machine on a platform or a poorly supported structure.

## Water temperature

Do not install the washing machine in areas where water may freeze as the washing machine always retains some water in its water valves, pumps, and/or hoses. Frozen water left in the connection parts may cause damage to belts, the pump, and other components of the washing machine.

## Alcove or closet installation

Minimum clearance for stable operation:

Sides	25 mm	Rear	50 mm
Top	25 mm	Front	550 mm

If both the washing machine and a dryer are installed in the same location, the front of the alcove or closet must have at least a 550 mm unobstructed air opening. Your washing machine alone does not require a specific air opening.

# Step-by-step installation

## STEP 1 - Select a location

Location requirements:

- Solid, level surface without carpeting or flooring that may obstruct ventilation
- Away from direct sunlight
- Adequate room for ventilation and wiring
- The ambient temperature is always higher than the freezing point (0 °C)
- Away from a heat source

## STEP 2 – Remove the shipping bolts

Unpack the product package and remove all shipping bolts.

1. Loosen all shipping bolts on the rear of the machine using the supplied spanner.

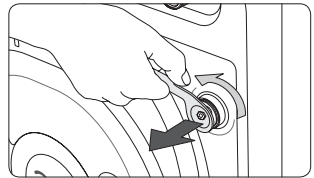

2. Fill the holes with the supplied bolt hole covers.



**CAUTION:** To prevent lint, dust, or other particles from accumulating inside your washing machine, fill the two **bottom holes (A)** with the bolt hole covers.

3. Store all shipping bolts in a safe location where they can be easily retrieved in the event that you have to move the washing machine.

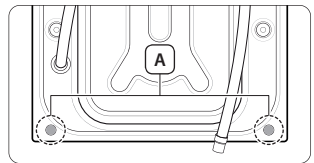
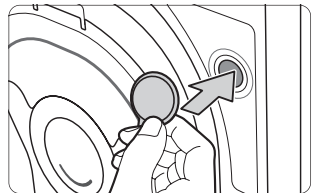

### WARNING

Packaging materials can be dangerous to children. Dispose all packaging material (plastic bags, polystyrene, etc.) out of children's reach.

## STEP 3 - Adjust the levelling feet

1. Gently slide the washing machine into position. Excessive force may damage the levelling feet.
2. Level the washing machine by manually adjusting the levelling feet.
3. When levelling is complete, tighten the nuts using the spanner.

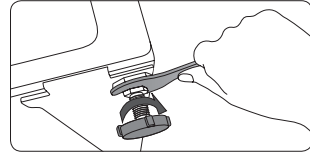
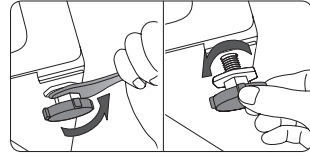

## STEP 4 - Connect the water hose

### Connect the water supply hose to the water tap.

1. Remove the adaptor (A) from the water supply hose (B).

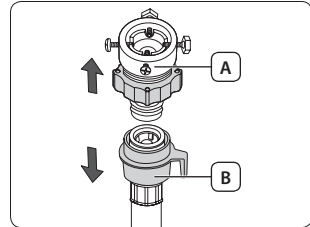

2. Use a Philips screwdriver to loosen four screws on the adaptor.

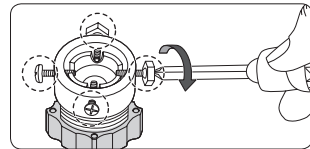

3. Hold the adaptor and turn **part (C)** in the arrow direction to loosen it by 5 mm (\*).

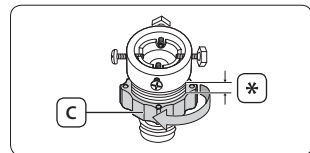

4. Insert the adaptor into the water tap, and tighten the screws while lifting up the adaptor.
5. Turn **part (C)** in the arrow direction to tighten it.

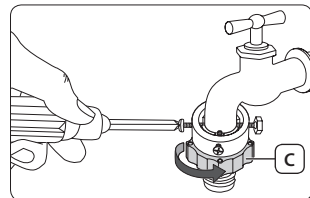

6. While holding down **part (E)**, connect the water supply hose to the adaptor. Then, release **part (E)**. The hose fits into the adaptor with a clicking sound.

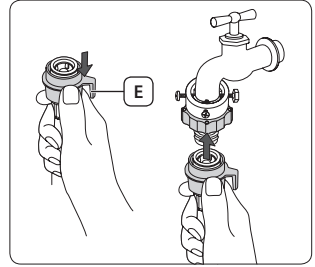

7. Connect the other end of the water supply hose to the inlet valve on the back of the washing machine. Turn the hose clockwise to tighten.

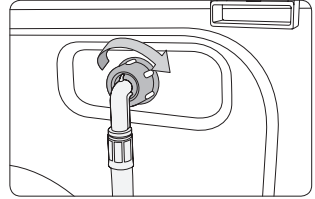

8. Open the water tap and check if there are any leaks around the connection areas. If there are water leaks, repeat the steps above.

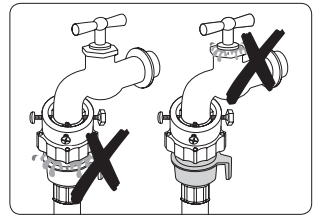

- If using a screw type of water tap, connect the water hose to the water tap as shown.

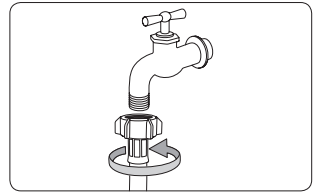

**⚠ WARNING**

Stop using the washing machine if there is a water leak, and contact a local Samsung service centre. Otherwise, this may cause electric shock.

**⚠ CAUTION**

Do not stretch the water supply hose by force. If the hose is too short, replace the hose with a longer, high-pressure hose.



- After connecting the water supply hose to the adaptor, check if it is connected properly by pulling the water supply hose downwards.
- Use a popular type of water taps. If the tap is square-shaped or too big, remove the spacer ring before inserting the tap into the adaptor.

### For models with an additional hot water inlet:

1. Connect the red end of the hot water supply hose to the hot water inlet on the back of the machine.
2. Connect the other end of the hot water supply hose to the hot water tap.

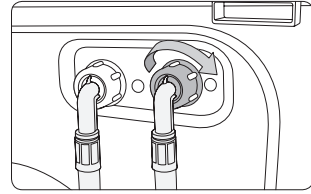

### Aqua hose (applicable models only)

The aqua hose alerts users of a risk of water leaks. It senses the water flow and turns red on the centre **indicator (A)** in case of a leak.

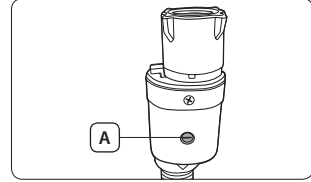

## STEP 5 - Position the drain hose

The drain hose can be positioned in three ways:

### Over the edge of a wash basin

The drain hose must be placed at a height of between 60 cm and 90 cm (\*) from the floor. To keep the spout of the drain hose bent, use the supplied **plastic hose guide (A)**. Secure the guide to the wall using a hook to ensure stable drainage.

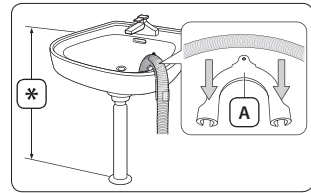

### In a sink drain pipe

The drain pipe must be above the sink siphon so that the end of the hose is at least 60 cm above the floor.

### In a drain pipe

The drain pipe should be between 60 cm and 90 cm high (\*). It is advisable to use a 65 cm high vertical pipe. Make sure the drain hose is connected to the stand pipe at a slant.

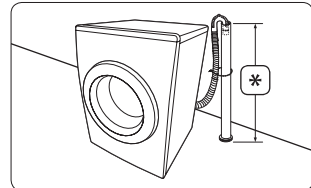

### Drain standpipe requirements:

- Minimum diameter of 5 cm
- Minimum carry-away capacity of 60 litres per minute

## STEP 6 – Turn on the washing machine

Plug the power cord into a wall socket featuring an AC 220-240 V / 50 Hz approved electrical outlet protected by a fuse or circuit breaker. Then, press the **Power** button to turn on the washing machine.

# Environment

---

Please dispose of the packaging materials for this product in an “environmentally friendly” manner. For further detail, please contact your local area authority.

# Screw cover

---

The door screw head can be hidden using the provided screw cover (x2).

## To hide the screw head (applicable models only)

1. Remove the protective film (A) and the release liner (B) on the screw cover.

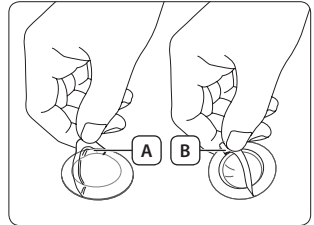

2. Put the screw cover (C) on the screw head.

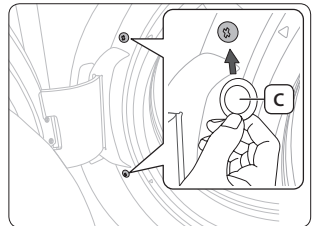

- The provided screw cover is designed for this purpose only.
- The screw cover comes with white-colored models only.

# Before you start

## Initial settings

---

### Set language

When you turn on the washing machine for the first time, you will be asked to choose a language. Select a preferred language. Then, the washing machine is ready for use.

### Run Calibration (recommended)

Calibration provides weight detection by the washing machine. Make sure the drum is empty before running Calibration.

1. Press the **Power** button to turn on the washing machine.
2. Press and hold the **Options** button for 3 seconds.
3. Press the **Up** (^) / **Down** (v) arrows to select **Calibration**. Then, press **OK**.
4. Press the **Start/Pause** button to start Calibration.
  - The door will be locked during the operation.
  - The drum keeps rotating clockwise and anticlockwise for several minutes.
5. When complete, the washing machine turns off automatically.

# Laundry guidelines

---

## STEP 1 - Sort

### Sort the laundry according to these criteria:

- **Care Label:** Sort the laundry into cottons, mixed fibres, synthetics, silks, wools, and rayon.
- **Colour:** Separate whites from colours.
- **Size:** Mixing different-sized items together in the drum may improve the washing performance.
- **Sensitivity:** Wash delicate items separately using an Easy Iron option for pure, new woollen items, curtains, and silk items. Check the labels on the items.



Make sure to check the care label on the clothing, and sort them accordingly before starting the wash.

## STEP 2 - Empty pockets

### Empty all the pockets of your laundry items

- Metal objects such as coins, pins, and buckles on clothing may damage other laundry items as well as the drum.

### Turn clothing with buttons and embroideries inside out

- If pants or jacket zippers are open while washing, the drum may be damaged. Zippers should be closed and fixed with a string.
- Clothing with long strings may become entangled with other clothes. Make sure to tie the strings before starting the wash.

## STEP 3 - Use a laundry net

- Brassieres (water washable) must be placed in a laundry net. Metal parts of the brassieres may break through and tear other laundry items.
- Small, light clothing such as socks, gloves, stockings, and handkerchiefs may become caught around the door. Place them inside a fine laundry net.
- Do not wash the laundry net by itself without other laundry. This may cause abnormal vibrations that could move the washing machine and result in injury.

## STEP 4 - Prewash (if necessary)

Select the Prewash option for the selected course if the laundry is heavily soiled. Do not use the Prewash option when detergent is manually added into the drum.

## STEP 5 - Determine the load capacity

Do not overload the washing machine. Overloading may cause the washing machine to not wash properly. For the load capacity for the type of clothing, see page 29.



When washing bedding or bedding covers, the wash time may be lengthened or the spin efficiency may be reduced. For bedding or bedding covers, the recommended maximum spin cycle speed is 800 rpm, and the load capacity is 2.0 kg or less.



### CAUTION

If the laundry is unbalanced and the “UE” error code is displayed, redistribute the load. Unbalanced laundry may reduce the spinning performance.

## STEP 6 - Apply a proper detergent type

The type of detergent depends on the type of fabric (cotton, synthetic, delicate items, wool), colour, wash temperature, and degree of soiling. Always use “low suds” laundry detergent, which is designed for automatic washing machines.



- Follow the detergent manufacturer’s recommendations based on the weight of the laundry, the degree of soiling, and the hardness of the water in your local area. If you are not sure about the water hardness, contact a local water authority.
- Do not use detergent that tends to be hardened or solidified. This detergent may remain after the rinse cycle, blocking the drain outlet.
- Powdered detergent should be thoroughly dissolved in a small amount of warm water before adding to the machine.



### CAUTION

When washing wool using the wool course, use only a neutral liquid detergent. If used with the Wool course, powder detergent may remain on the laundry and discolour the laundry.

# Detergent drawer guidelines

The washing machine provides a three-compartment dispenser: the left compartment for the main wash, the front-right for fabric softeners, and the rear-right for the preliminary wash.

①	<b>Prewash detergent compartment</b>
②	<b>Main wash detergent compartment:</b> powder detergents, water softeners, pre-soaking agents, bleach, and stain removers
⊗	<b>Fabric softener compartment</b>

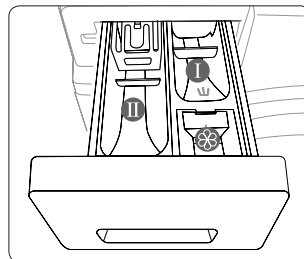

## ⚠ CAUTION

- Do not open the detergent drawer while the washing machine is operating.
- Do not use the following types of detergent:
  - Tablet or capsule types
  - Ball or net types
- To help prevent the compartment clogging, concentrated or highly-enriched agents (fabric softener or detergent) must be diluted with water before being applied.

The detergent drawer is located at the top-left corner of the washing machine.

1. Slide open the detergent drawer.
2. Apply an appropriate amount of detergent to the left compartment (②).

To use a liquid detergent, see the Liquid detergent guide below.

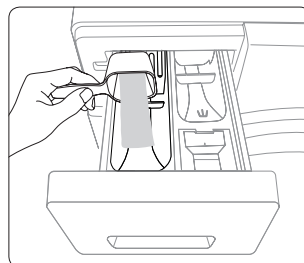

3. Apply an appropriate amount of fabric softener to the front-right compartment (⊗) if necessary.

Do not exceed the max line (A) which is marked on the compartment.

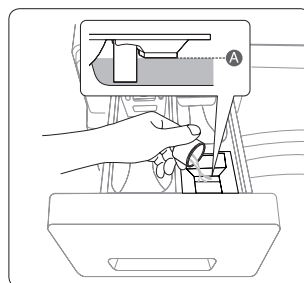

4. If selecting the Prewash option, apply an appropriate amount of detergent to the rear-right compartment (I).
5. Slide the detergent drawer inward to close it.

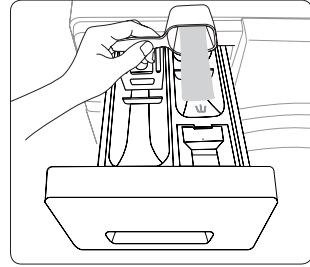

## Liquid detergent container (Applicable models only)

To use a liquid detergent, first put the provided **liquid detergent container** in the main wash detergent compartment (II). Then, apply an appropriate amount of detergent to the container. Do not exceed the max line which is marked on the inner of the container.



### CAUTION

Remove the liquid detergent container if using a powder detergent.

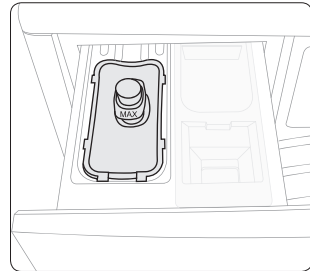

# Operations

## Control panel

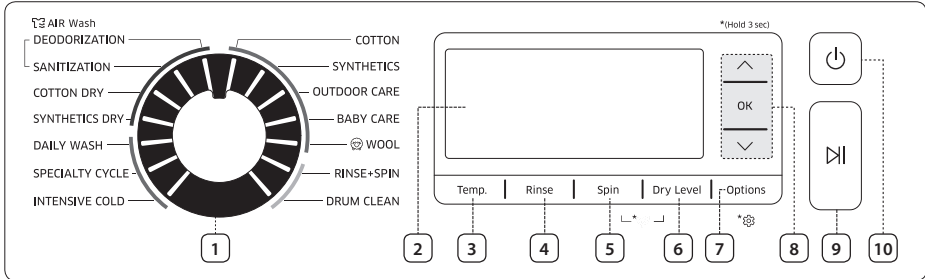

1	<b>Course Selector</b>	Turn the dial to select a course.
2	<b>Display area</b>	Displays information of the current course including the course name, remaining washing time, and settings.
3	<b>Temp.</b>	Press to change the water temperature for the current course.
4	<b>Rinse</b>	Press to change the rinse times for the current course. You can set the rinse times up to 5, depending on the course.
5	<b>Spin</b>	Press to change the spinning speed for the current course. <ul style="list-style-type: none"> <li>• <b>Rinse Hold:</b> The final rinse cycle is suspended so that the laundry remains in the water. To unload the laundry, run a drain or spin cycle.</li> <li>• <b>No Spin:</b> The drum does not spin after the final drain cycle.</li> </ul>
6	<b>Dry Level</b>	Press to select a drying level:  Cupboard >  Extra Dry >  Iron >  Time Dry (30 min > 1:00 h > 1:30 h > 2:00 h > 2:30 h > 3:00 h > 3:30 h > 4:00 h > 4:30 h) > — No Dry <ul style="list-style-type: none"> <li>•  <b>Cupboard:</b> Use this option to dry laundry such as cotton, underwear, and linen.</li> <li>•  <b>Extra Dry:</b> Use this option to dry heavy garments such as jeans, corduroys and towels.</li> <li>•  <b>Iron:</b> Use this option to finish the drying cycle in a moist state for ironing.</li> <li>•  <b>Time Dry:</b> Use this option to dry the laundry for the specified period of time depending on the fibres, amount of laundry quantity and moisture.</li> <li>• <b>— No Dry:</b> Use this option if not using a drying course.</li> </ul>
7	<b>Options</b>	Press to enter the Options screen.
8	<b>Navigation buttons</b>	Use to navigate through the menus or to adjust the value of the settings: Temp., Rinse, and Spin.
9	<b>Start/Pause</b>	Press to start or stop an operation.

**10 Power** Press to turn on/off the washing machine.

 For detailed settings, see page 33.

## Simple steps to start

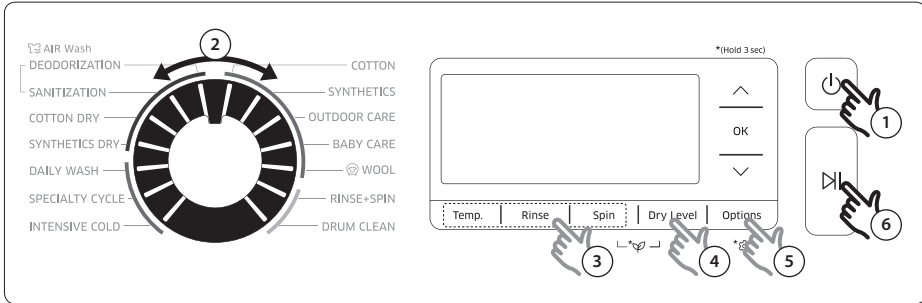

1. Press the **Power** button to turn on the washing machine.
2. Turn the Course Selector to select a course.
3. Change the course settings (**Temp.**, **Rinse**, and **Spin**) as necessary.
4. To select a Dry Level, press the **Dry Level** to display the Dry Level screen. Press the **Up** (^) / **Down** (v) arrows to select a mode, and press **OK**. Then, press **Dry Level** again to exit the screen. To enable Time Dry, specify a time and then press **OK**.
5. To add an option, press the **Options** button to display the Options screen. Press the **Up** (^) / **Down** (v) arrows to select an option item, and press **OK**.
6. Press the **Start/Pause** button.

## Drying only

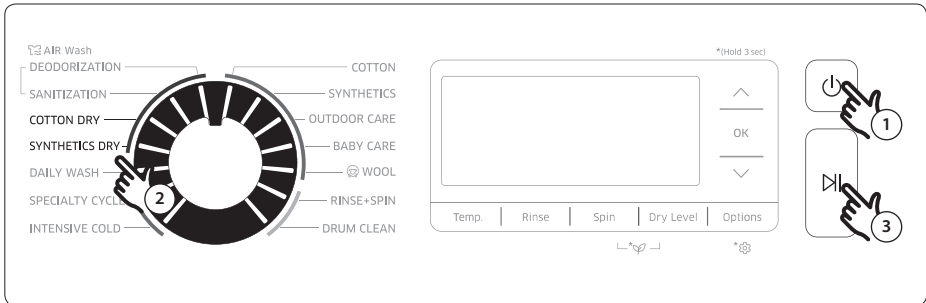

Follow these steps to dry laundry that has finished washing or has simply got wet.

1. Press the **Power** button to turn on the washing machine.
2. Turn the Course Selector to **COTTON DRY** or **SYNTHETICS DRY**.
3. Press the **Start/Pause** button.

### To change the course during operation

1. Press the **Start/Pause** button to stop operation.
2. Select a different course.
3. Press the **Start/Pause** button again to start the new course.

# Course overview

## Standard courses

Course	Description & Max load (kg)	
<b>COTTON</b>	<ul style="list-style-type: none"> <li>Suitable for a normally soiled cotton load.</li> <li>For cottons, bed linens, table linens, underwear, towels, or shirts.</li> <li>The washing time and the number of rinse cycles are automatically adjusted according to the load.</li> <li>Cotton, 40 °C, 2 Rinses, Intensive, 1400 rpm is the test programme used for energy labeling in accordance with AS/NZS 2040.</li> </ul>	10
<b>SYNTHETICS</b>	<ul style="list-style-type: none"> <li>For blouses or shirts that are made of polyester (diolen, trevira), polyamide (perlon, nylon), or the like.</li> </ul>	6
<b>OUTDOOR CARE</b>	<ul style="list-style-type: none"> <li>For outdoor clothes, skiwear, and sportswear that are made of functional materials such as spandex, stretch, and microfibre.</li> </ul>	2
<b>BABY CARE</b>	<ul style="list-style-type: none"> <li>Featuring a high-temperature wash and extra rinses to ensure that no powder detergent remains.</li> </ul>	6
<b>WOOL</b>	<ul style="list-style-type: none"> <li>Specific for machine-washable wool for loads less than 2.0 kg.</li> <li>The wool course features gentle cradling and soaking to help protect the wool fibres from shrinkage/distortion.</li> <li>A neutral detergent is recommended.</li> </ul>	2
<b>RINSE+SPIN</b>	<ul style="list-style-type: none"> <li>Featuring an additional rinse after applying fabric softener to the laundry.</li> </ul>	-
<b>DRUM CLEAN</b>	<ul style="list-style-type: none"> <li>Cleans the drum by removing dirt and bacteria from the drum.</li> <li>Perform once every 40 washes with no detergent or bleach applied.</li> <li>Make sure the drum is empty.</li> <li>Do not use any cleaning agents for cleaning the drum.</li> </ul>	-
<b>DEODORIZATION</b>	<ul style="list-style-type: none"> <li>Designed to remove bad odors from the laundry.</li> </ul>	1
<b>SANITIZATION</b>	<ul style="list-style-type: none"> <li>Use this cycle to help remove bad odors and bacteria from the laundry.</li> </ul>	1
<b>COTTON DRY</b>	<ul style="list-style-type: none"> <li>For general drying.</li> <li>Cotton Dry (Cupboard), Spin 1400 rpm is the test program used for energy labeling in accordance with AS/NZS 2442.</li> </ul>	5
<b>SYNTHETICS DRY</b>	<ul style="list-style-type: none"> <li>A low temperature drying cycle for heat-sensitive garments.</li> </ul>	3
<b>DAILY WASH</b>	<ul style="list-style-type: none"> <li>For everyday items such as underwear and shirts.</li> </ul>	4
<b>INTENSIVE COLD</b>	<ul style="list-style-type: none"> <li>Low-temperature Bubble.</li> </ul>	6

## SPECIALTY CYCLE











Six specialty courses are designed to effectively remove specific types of stains and dirt that may accumulate on specific types of activities ranging from household work to professional mountain-climbing.

Course	Description & Max load (kg)	
<b>Cooking&amp;Dining</b>	<ul style="list-style-type: none"><li>This course is designed to remove food spills and cooking stains.</li></ul>	4
<b>Gardening</b>	<ul style="list-style-type: none"><li>This course is designed to remove grass and mud/dirt stains and cleans sweat and skin oils.</li></ul>	4
<b>Active Sports</b>	<ul style="list-style-type: none"><li>This course removes grass, soil, mud, light food stains, sweat, and make-up.</li><li>Do not use this course for waterproof clothing. This may result in damage to the waterproof or breathable capabilities.</li></ul>	4
<b>Active Kids</b>	<ul style="list-style-type: none"><li>The Active Kids course is for most children's clothing. This course is designed to remove food, fruit juice, drinks, mud, soil, ink, and crayon stains.</li></ul>	4
<b>Working&amp;Everyday</b>	<ul style="list-style-type: none"><li>The Working&amp;Everyday course is for lightly soiled clothing. This course is designed to remove light ink and pencil stains and cleans normal day to day stains efficiently.</li></ul>	4
<b>Hygiene Care</b>	<ul style="list-style-type: none"><li>This course is designed to remove skin oils and blood stains efficiently.</li></ul>	4

### To select a SPECIALTY CYCLE

1. Turn the Course Selector to select **SPECIALTY CYCLE**. The SPECIALTY CYCLE screen appears.
2. Press the **Up** (∧) / **Down** (∨) arrows to select a course, and then press **OK**.

## Options

Option		Description
	<b>Pre Wash</b>	<ul style="list-style-type: none"> <li>This will add a preliminary washing cycle before the main wash cycle.</li> </ul>
	<b>Intensive</b>	<ul style="list-style-type: none"> <li>For badly soiled laundry. The operation time for each cycle is longer than normal.</li> </ul>
	<b>Soak</b>	<ul style="list-style-type: none"> <li>This option helps remove stains by soaking the laundry.</li> <li>Each soak cycle spins the drum for 1 minute and stands still for 4 minutes, totaling 6 times for 30 minutes.</li> </ul>
	<b>Easy Iron</b>	<ul style="list-style-type: none"> <li>The spinning speed decreases to reduce wrinkles of the laundry.</li> <li>Set the spinning speed up to 800 rpm.</li> </ul>
	<b>Quick Wash</b>	<ul style="list-style-type: none"> <li>Specific to less soiled garments with less than a 2 kg load.</li> <li>It takes a minimum of about 15 minutes, depending on the conditions such as the water pressure, water hardness, and/or extra options selected.</li> <li>The Quick Wash time increases in this sequence: Off &gt; 15 min &gt; 20 min &gt; 30 min &gt; 40 min &gt; 50 min &gt; 60 min.</li> <li>A recommended amount of detergent is less than 20 g (for a 2 kg load)</li> </ul>
	<b>Delay End</b>	<ul style="list-style-type: none"> <li>The displayed time refers to the end time of a selected course.</li> </ul>
	<b>Prefer Mode</b>	<ul style="list-style-type: none"> <li> <b>Speed Wash:</b> This changes the course settings to reduce the overall washing time. The recommended laundry load is less than 6.0 kg for the COTTON course with Speed Wash enabled.</li> <li> <b>Eco Wash:</b> This changes the course settings to save the overall power consumption.</li> <li> <b>Silent Wash:</b> This changes the course settings to reduce operating noise and vibration.</li> </ul>

## Delay End

You can set the washing machine to finish the current course at a specific number of hours later. This feature can be used to finish the wash by the time you come home from work.

1. Select a course. Then change the course settings if necessary.
2. Press the **Options** button.  
Then, select options by pressing **Up** (^) / **Down** (v) and **Ok**.
3. Select the **Delay End**.
4. Use the arrows to set the end time of the current course, and press **OK**.
5. Press **Start/Pause** button.

### Use case

You want to finish a two-hour course at 5:00 p.m. For this, you add the Delay End option to the current course with the 3-hour setting, and press the Start/Pause button at 2:00 p.m. Then, what happens? The washing machine starts operating at 3:00 p.m., and ends at 5:00 p.m. Provided below is the time line for this example.



## Settings (\*⚙️)

Press and hold **Options** button for more than 3 seconds to enter the Settings screen.

### Child Lock

To help prevent accidents by children or infants, Child Lock locks the door and all buttons except for the **Power** button. However, Child Lock does not activate until you press the **Start/Pause** button. Until then, you can change settings by pressing the corresponding buttons.

- To activate the Child Lock, press the **Up** (^) / **Down** (v) arrows to select Child Lock and press **OK**.
- To suspend or deactivate the Child Lock, select Child Lock and press **OK** once to suspend it, or press **OK** twice to deactivate it.

(In the suspended state, you can open the door or manipulate buttons. However, once the washing machine starts operation, it will reactivate the Child Lock)



To add detergent or more laundry in the drum, or to change the course settings in the Child Lock state, you must first stop or release the Child Lock.

When the washing machine is turned off with Child Lock enabled, the door will remain locked unless Child Lock is deactivated.

### Language

Select a preferred menu language.

1. Press the **Up** (^) / **Down** (v) arrows to select **Language** and press **OK**.
2. Press the **Up** (^) / **Down** (v) arrows to select preferred menu language and press **OK**.

### Sound

Mute or unmute the sound.

- To mute or unmute the sound, press the **Up** (^) / **Down** (v) arrows to select **Sound** and press **OK** to on or off.

### Brightness

Set the brightness of LCD screen

1. Press the **Up** (^) / **Down** (v) arrows to select **Brightness** and press **OK**.
2. Press the **Up** (^) / **Down** (v) arrows to increase or decrease the brightness level and press **OK**.

### License Info

- Press the **Up** (^) / **Down** (v) arrows to select **License Info** and press **OK**.

## Calibration

Calibration provides weight detection by the washing machine. Make sure the drum is empty before running Calibration.

1. Press the **Up** (^) / **Down** (v) arrows to select **Calibration**. Then, press **OK**.
2. Press the **Start/Pause** button to start Calibration.
  - The door will be locked during the operation.
  - The drum keeps rotating clockwise and anticlockwise for several minutes.
3. When complete, the washing machine turns off automatically.

## Eco Check

The energy/water efficiency of the current course is displayed with a technical summary of power consumption and water level. You can check the energy/water efficiency on the display before a course is selected and started.

- Press and hold the **Spin** and **Dry Level** buttons simultaneously for 3 seconds. A summary screen appears.



The technical summary may differ from actual usage.

# Maintenance

Keep the washing machine clean to prevent deteriorated performance and to preserve its life cycle.

## Drum clean

---

Perform this course regularly to clean the drum and to help remove bacteria from it.

1. Press the **Power** button to turn on washing machine.
2. Turn the Course Selector to select **DRUM CLEAN**.
3. Press the **Start/Pause** button.



The water temperature for DRUM CLEAN is set to 70 °C, which cannot be changed.



### CAUTION

Do not use any cleaning agents for cleaning the drum. Chemical residue in the drum deteriorates the washing performance.

## Drum clean reminder

- The DRUM CLEAN reminder appears on the main screen once every 40 washes. It is advisable to perform the DRUM CLEAN regularly.
- When you first see this reminder, you can ignore the reminder for 6 consecutive times. From the 7th wash, the reminder does not appear. However, it appears again on the second 40th wash.

# Smart check

---

To enable this function, you must first download the **Samsung Smart Washer** at the Play Store or the Apple Store, and install it on a compliant mobile device featuring the camera operation.

The Smart Check function has been designed for:

Galaxy & iPhone series (cannot be supported for some models)

The washing machine runs the self-diagnosis in the background, and displays an error code if an error is found. If this is the case, follow the steps below:

1. Run the **Samsung Smart Washer** app on your mobile device, and tap Smart Check.
2. Present the mobile device to the washing machine's display panel so that the mobile device and the washing machine face each other. Then, the error code will be recognized automatically by the app.
3. When the error code is recognized correctly, the app provides detailed information for the error with further actions.



- The function name, Smart Check, may differ depending on the language.
- If the washing machine reflects light on the display, the app may fail to recognize the error code.
- If the app fails to recognize the Smart Check code consecutively, enter the error code manually onto the app screen.

## Emergency drain

In case of a power failure, drain the water inside the drum before taking out the laundry.

1. Unplug the power cord of the washing machine from the main socket.
2. Gently press the top area of the filter cover to open.

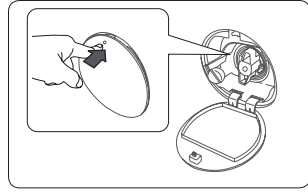

3. Gently pull out the emergency drain tube.

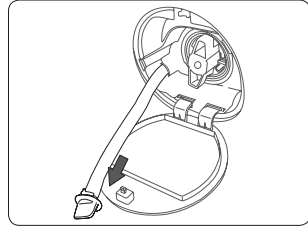

4. While holding the end of the drain tube, open the tube cap.

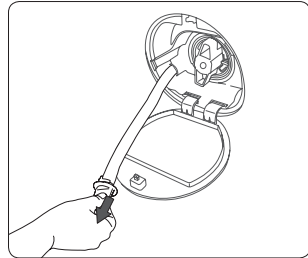

5. Let the water run into a container.
6. Close the tube cap, and reinsert the drain tube.
7. Close the filter cover.

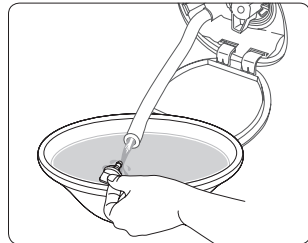

# Cleaning

---

## Surface of the washing machine

Use a soft cloth with a nonabrasive household detergent. Do not spray water onto the washing machine.

## Mesh filter

Clean the mesh filter of the water supply hose once or twice a year.

1. Turn off the washing machine, and unplug the power cord.
2. Close the water tap.
3. Loosen and disconnect the water supply hose from the back of the washing machine. Cover the hose with a cloth to prevent water from gushing out.

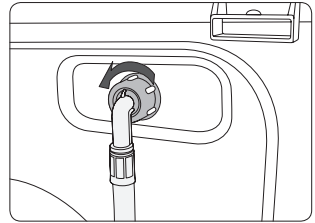

4. Use pliers to pull out the mesh filter from the inlet valve hole.
5. Submerge the mesh filter deeply in water so that the threaded connector is also submerged.
6. Dry the mesh filter completely in the shade.
7. Reinsert the mesh filter into the inlet valve, and reconnect the water supply hose to the inlet valve.
8. Open the water tap.

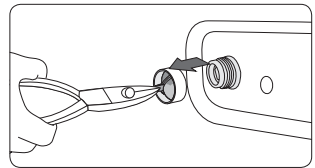

If the mesh filter is clogged, an error code of “**4E**” appears on the screen.

## Debris filter

It is advisable to clean the debris filter 5 or 6 times a year to prevent its clogging. A clogged debris filter may reduce the bubble effect.

1. Turn off the washing machine, and unplug the power cord.
2. Drain the remaining water inside the drum by referring to **“Emergency drain”** on page 37.
3. Open the filter cover using a coin or key.
4. Turn the debris filter cap to the left, and drain off the remaining water.
5. Remove the debris filter.

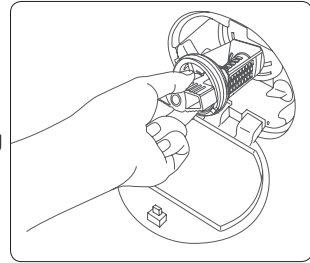

6. Clean the debris filter using soft brushes. Make sure the drain pump propeller inside the filter is unclogged.
7. Reinsert the debris filter, and turn the filter cap to the right.

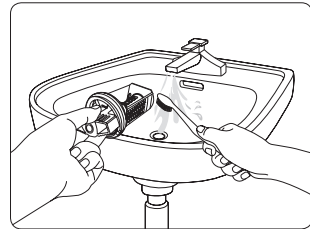

-  • To open the safety filter cap, push in and turn it anticlockwise. The spring of the cap helps to open the cap.
- To close the safety filter cap, turn it clockwise. The spring makes a rattling sound, which is normal.

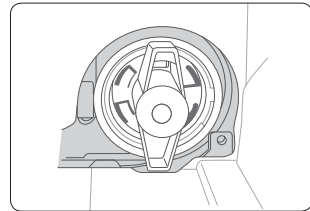

-  • If the debris filter is clogged, an error code of **“5E”** appears on the screen.

### CAUTION

- Make sure the filter cap is closed properly after cleaning the filter. Otherwise, this may cause a leak.
- Make sure the filter is inserted properly after cleaning it. Otherwise, this may cause an operational failure or a leak.

## Detergent Drawer

1. While holding down the **release lever (A)** on the inner of the drawer, slide open the drawer.
2. Remove the **release lever** and the **liquid detergent container** from the drawer.

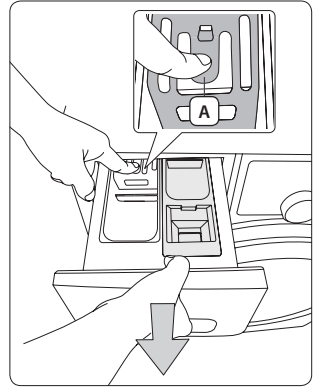

3. Clean the drawer components in flowing water using a soft brush.

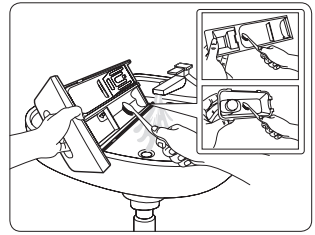

4. Clean the drawer recess using a soft brush.
5. Reinsert the **release lever** and the **liquid detergent container** to the drawer.
6. Slide the drawer inward to close it.

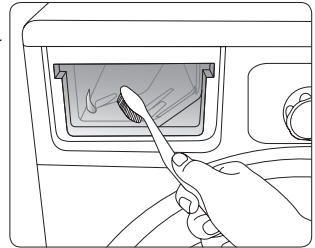

-  To remove remaining detergent, perform the **RINSE+SPIN** course with the drum being empty.

## Recovery from freezing

---

The washing machine may freeze when it drops below 0 °C.

1. Turn off the washing machine, and unplug the power cord.
2. Pour warm water over the water tap to loosen the water supply hose.
3. Disconnect the water supply hose, and soak it in warm water.
4. Pour warm water into the drum and leave it for about 10 minutes.
5. Reconnect the water supply hose to the water tap.



If the washing machine still doesn't operate normally, repeat the above steps until it operates normally.

## Care against an extended time of disuse

---

Avoid leaving the washing machine unused for an extended time.

If this is the case, drain the washing machine and unplug the power cord.

1. Turn the Course Selector to select a **RINSE+SPIN**.
2. Empty the drum, and press **Start/Pause** button.
3. When the course is complete, close the water tap and disconnect the water supply hose.
4. Turn off the washing machine, and unplug the power cord.
5. Open the door to let air circulate through the drum.

# Troubleshooting

## Checkpoints

---

If you encounter a problem with the washing machine, first check the table below and try the suggestions.

Problem	Action
The washing machine won't start.	<ul style="list-style-type: none"><li>• Make sure the washing machine is plugged in.</li><li>• Make sure the door is properly closed.</li><li>• Make sure the water tap is open.</li><li>• Press the <b>Start/Pause</b> button again.</li></ul>
Water supply is insufficient, or no water is supplied.	<ul style="list-style-type: none"><li>• Open the water tap fully.</li><li>• Make sure the water supply hose is not frozen.</li><li>• Make sure the water supply hose is not kinked or clogged.</li><li>• Clean the filter on the water supply hose.</li></ul>
Has detergent remaining in the detergent drawer after the wash cycle is complete	<ul style="list-style-type: none"><li>• Make sure your washing machine is running with sufficient water pressure.</li><li>• Make sure the detergent is added to the center of the detergent drawer.</li></ul>
The washing machine vibrates badly or makes noise.	<ul style="list-style-type: none"><li>• Make sure the washing machine is installed on a level floor. If the floor is not level, use the levelling feet to adjust the level.</li><li>• Make sure that the shipping bolts are removed.</li><li>• Make sure the washing machine is not touching any other object.</li><li>• Make sure the laundry load is balanced.</li></ul>
The washing machine does not drain and/or spin.	<ul style="list-style-type: none"><li>• Make sure the drain hose is straightened all the way to the drain system.</li><li>• Make sure the debris filter is not clogged.</li></ul>
The door won't open.	<ul style="list-style-type: none"><li>• Press the <b>Start/Pause</b> button to stop the washing machine.</li><li>• The door stays locked as long as the washing machine is still hot inside after a heating operation.</li><li>• Deactivate the Child Lock if activated.</li></ul>

If a problem persists, contact a local Samsung service centre.

## Information codes

If the washing machine fails to operate, you may see an information code on the screen. Check the table below and try the suggestions.

Problem	Action
dE	<ul style="list-style-type: none"> <li>• Make sure the door is properly closed.</li> <li>• Make sure laundry is not caught in the door.</li> </ul>
4E	<ul style="list-style-type: none"> <li>• Make sure the water tap is open.</li> <li>• Make sure the washing machine is operating with sufficient water pressure,</li> <li>• Clean the mesh filter as it may be clogged.</li> </ul>
5E	<ul style="list-style-type: none"> <li>• Clean the debris filter as it may be clogged.</li> <li>• Make sure the drain hose is not kinked all the way to the drain system.</li> </ul>
UE	<ul style="list-style-type: none"> <li>• The laundry load is unbalanced. Spread the laundry evenly.</li> </ul>
cE/3E/Uc	<ul style="list-style-type: none"> <li>• This is not user-repairable. Contact a local Samsung service centre.</li> </ul>

If any information code keeps appearing on the screen, contact a local Samsung service centre.

# Specifications

























## Protecting the environment

---

- This appliance is manufactured from recyclable materials. If you decide to dispose of this appliance, please observe local waste disposal regulations. Cut off the power cord so that the appliance cannot be connected to a power source. Remove the door so that animals and small children cannot get trapped inside the appliance.
- Do not exceed the detergent quantities recommended in the detergent manufacturer's instructions.
- Use stain removal products and bleaches before the wash cycle only when strictly necessary.
- Save water and electricity by only washing full loads (the exact amount depends upon the program used).

## Fabric care chart

The following symbols provide garment care directions. The care labels include four symbols in this order: washing, bleaching, drying and ironing (and dry cleaning when necessary). The use of symbols ensures consistency among garment manufacturers of domestic and imported items. Follow the care label directions to maximize garment life and reduce laundry problems.

	Resistant material		Do not iron
	Delicate fabric		Can be dry cleaned using any solvent
	Item can be washed at 95 °C		Dry Clean
	Item can be washed at 60 °C		Dry clean with perchloride, lighter fuel, pure alcohol or R113 only
	Item can be washed at 40 °C		Dry clean with aviation fuel, pure alcohol or R113 only
	Item can be washed at 30 °C		Do not dry clean
	Hand wash only		Dry flat
	Dry clean only		Can be hung to dry
	Can be bleached in cold water		Dry on clothes hanger
	Do not bleach		Tumble dry, normal heat
	Can be ironed at 200 °C max		Tumble dry, reduced heat
	Can be ironed at 150 °C max		Do not tumble dry
	Can be ironed at 100 °C max		

# Specification sheet

TYPE		FRONT LOADING WASHING MACHINE	
MODEL NAME		WD10J8*****	
WASH AND SPIN CAPACITY		10.0 kg	
DRY CAPACITY		5.0 kg	
DIMENSIONS		W600xD600xH850 (mm)	
WATER PRESSURE		50 kPa ~ 800 kPa	
WATER VOLUME		78 ℓ	
NET WEIGHT		82 kg	
POWER CONSUMPTION	WASHING	220 V	150 W
		240 V	150 W
	WASHING AND HEATING	220 V	2000 W
		240 V	2400 W
	SPIN	220 V	600 W
		240 V	600 W
	DRY	220 V	1600 W
		240 V	1900 W
PUMPING		30 W	
SPIN REVOLUTIONS		rpm	1400

# Memo



## QUESTIONS OR COMMENTS?

COUNTRY	CALL	OR VISIT US ONLINE AT
AUSTRALIA	1300 362 603	<a href="http://www.samsung.com/au/support">www.samsung.com/au/support</a>



DC68-03483F-00