

PHILIPS

Smart soundbar

PB405

User manual



Register your product and get support at
www.philips.com/welcome

Contents

1	Important	2
	Help and support	2
	Important safety instructions	2
	Care for your product	3
	Care of the environment	3
	Compliance	4

2	Your SoundBar	4
	Main unit	4
	Remote control	6
	Connectors	7

3	Connect	7
	Placement	7
	Connect the SoundBar and Subwoofer	8
	Pair the Subwoofer manually	8
	Connect audio from TV and other devices	9

4	Use your SoundBar	10
	Adjust the volume	10
	MP3 player	10
	TV play	11
	Play audio through Bluetooth	11
	Google Voice Assistant	12
	Google Chromecast Built-in	12
	AirPlay 2	13
	Apply factory settings	14

5	Wall mount	14
----------	-------------------	-----------

6	Product specifications	15
----------	-------------------------------	-----------

7	Troubleshooting	16
----------	------------------------	-----------

I Important

Read and understand all instructions before you use your product. If damage is caused by failure to follow instructions, the warranty does not apply.

Help and support

For extensive online support, visit www.philips.com/support to:

- download the user manual and the quick start guide
- watch video tutorials (available only for selected models)
- find answers to frequently answered questions (FAQs)
- email us a question
- chat with our support representative.

Follow the instructions on the website to select your language, and then enter your product model number.

Alternatively, you can contact Consumer Care in your country. Before you contact, note down the model number and serial number of your product. You can find this information on the back or bottom of your product.

Important safety instructions

- **Read these instructions.**
- **Keep these instructions.**
- **Heed all warnings.**
- **Follow all instructions.**
- **Do not use this apparatus near water.**
- **Clean only with dry cloth.**
- **Do not block any ventilation openings. Install in accordance with the manufacturer's instructions.**
- **Do not install near any heat sources** such as radiators, heat registers, stoves, or other apparatus (including amplifiers) that produce heat.
- **Do not defeat the safety purpose of**

the polarized or grounding-type plug. A polarized plug has two blades with one wider than the other. A grounding type plug has two blades and a third grounding prong. The wide blade or the third prong are provided for your safety. If the provided plug does not fit into your outlet, consult an electrician for replacement of the obsolete outlet.

- **Protect the power cord** from being walked on or pinched, particularly at plugs, convenience receptacles, and the point where they exit from the apparatus.
- **Only use attachments/accessories** specified by the manufacturer.
- **Use only with the cart, stand, tripod, bracket or table** specified by the manufacturer or sold with the apparatus. When a cart is used, use caution when moving the cart/apparatus combination to avoid injury from tip-over. 
- **Unplug this apparatus** during lightning storm or when unused for long periods of time.
- **Refer all servicing** to qualified service personnel. Servicing is required when the apparatus has been damaged in any way, such as power-supply cord or plug is damaged, liquid has been spilled or objects have fallen into the apparatus, the apparatus has been exposed to rain or moisture, does not operate normally, or has been dropped.
- **Battery usage CAUTION** -To prevent battery leakage which may result in bodily injury, property damage, or damage to the unit:
 - Install **all** batteries correctly, + and - as marked on the unit.
 - Do not mix batteries (**old** and **new** or **carbon** and **alkaline**, etc.).
 - Remove batteries when the unit is not used for a long time.
 - The batteries shall not be exposed to excessive heat such as sunshine, fire or the like.
 - Perchlorate Material - special handling may apply. See www.dtsc.ca.gov/

hazardouswaste/perchlorate.

- The product/remote control may contain a coin/button type battery, which can be swallowed. Keep the battery out of reach of children at all times! If swallowed, the battery can cause serious injury or death. Severe internal burns can occur within two hours of ingestion.
- If you suspect that a battery has been swallowed or placed inside any part of the body, seek immediate medical attention.
- When you change the batteries, always keep all new and used batteries out of reach of children. Ensure that the battery compartment is completely secure after you replace the battery.
- If the battery compartment cannot be completely secured, discontinue use of the product. Keep out of reach of children and contact the manufacturer.
- **Apparatus shall not be exposed to dripping or splashing.**
- **Do not place any sources of danger on the apparatus** (for example, liquid filled objects, lighted candles).
- This apparatus may contain lead and mercury. Dispose according to local, State or Federal laws. For disposal or recycling information, please contact your local authorities. For additional assistance on recycling options, please contact www.mygreenelectronics.com or www.eiae.org or www.recycle.philips.com.
- Where the MAINS plug or an appliance coupler is used as the disconnect device, the disconnect device shall remain readily operable.
- Do not place this apparatus on the furniture that is capable of being tilted by a child and an adult leaning, pulling, standing or climbing on it. A falling apparatus can cause serious injury or even death.
- This apparatus should not be placed in a built-in installation such as a bookcase or rack unless proper ventilation is provided. Make sure to leave a space of 7.8 inches (20cm) or more around this apparatus.

Class II equipment symbol



This symbol indicates that the unit has a double insulation system.

Know these safety symbols



This 'bolt of lightning' indicates uninsulated material within your unit may cause an electrical shock. For the safety of everyone in your household, please do not remove product covering.



The 'exclamation point' calls attention to features for which you should read the enclosed literature closely to prevent operating and maintenance problems.

WARNING: To reduce the risk of fire or electric shock this apparatus should not be exposed to rain or moisture and objects filled with liquids, such as vases, should not be placed on this apparatus.

CAUTION: To prevent electric shock match wide blade of plug to wide slot, fully insert.

Care for your product

Use only microfiber cloth to clean the product.

Care of the environment

Disposal of your old product and battery



Your product is designed and manufactured with high quality materials and components, which can be recycled and reused.



This symbol on a product means that the product is covered by European Directive 2012/19/EU.



This symbol means that the product contains batteries covered by European Directive 2013/56/EU which cannot be disposed of with normal household waste. Inform yourself about the local separate collection system for electrical and electronic products and batteries. Follow local rules and never dispose of the product and batteries with normal household waste. Correct disposal of old products and batteries helps prevent negative consequences for the environment and human health.

Removing the disposable batteries

To remove the disposable batteries, see battery installation section.

Compliance

This product complies with the radio interference requirements of the European Community. Hereby, MMD Hong Kong Holding Limited declares that this product is in compliance with the essential requirements and other relevant provisions of Directive 2014/53/EU. You can find the Declaration of Conformity on www.p4c.philips.com.

2 Your SoundBar

Congratulations on your purchase, and welcome to Philips! To fully benefit from the support that Philips offers, register your SoundBar at www.philips.com/welcome.

Main unit

This section includes an overview of the main unit.

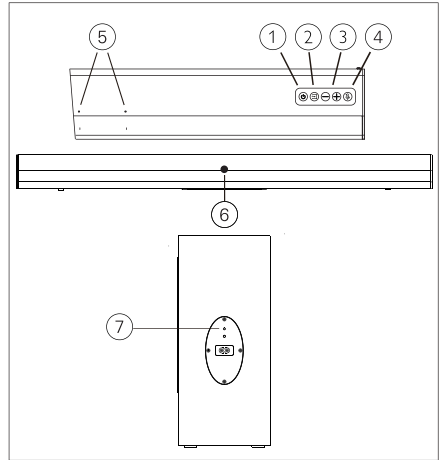

- ① Switch the soundbar on/off.
- ② (SOURCE) Select an input source for the soundbar.
- ③ Volume+/- Increase or decrease volume.
- ④ Press button for Mic mute on/off.
- ⑤ **Microphone**

⑥ Soundbar's LED indicator

POWER ON:

- Show default input source led indicator at first time, afterwards, goes to last status e.g. input source, led indicator, volume level and microphone mute or un-mute
(Notes: if no actions in 3mins, the source led indicator will automatically off).

BASS&TREBLE STATUS:

(level range:-12~+12, default level:0)

- (NOTES: IF the BASS&TREBLE's level is above 0, the four RGB leds lit up from left to right;
the BASS&TREBLE's level is 0, no indicator; the BASS&TREBLE's level is below 0, the four RGB LEDs lit up from right to left.)



- One of four RGB leds lit up from dim to solid brightness when BASS&TREBLE's level at +3/-3 in 0.5s.



- Two of four RGB leds lit up when BASS&TREBLE's level at +6/-6 in 0.5s, 1st LED keep solid, 2nd LED will lit up from dim to solid brightness.



- Three of four RGB leds lit up when BASS&TREBLE's level at +9/-9 in 0.5s, the first two LED keep solid, but 3rd LED will lit up from dim to solid brightness.



- Four RGB leds lit up when BASS&TREBLE's level at +12/-12 in 0.5s, 3 LEDs keep solid, but 4th LED will lit up from dim to solid brightness.

BLUETOOTH STATUS:

- Pairing mode: blue led fast flash
- Connected: solid blue
- Disconnect: blue led slow flash

MIC MUTE STATUS:

- Micphone Mute: 4 RGB Orange

AUX IN STATUS:

- AUX IN/Audio in :Solid Green

OPTICAL IN STATUS:

- OPTICAL IN: Solid purple

HDMI IN STATUS:

- HDMI ARC: Solid Cyan

VOLUME MUTE:

- Press volume mute button on remote, current led change to white color (keep mute when change to another source). Press volume mute button again, led change back to current source led.

GOOGLE ASSISTANT TRIGGER:

- System Boost up: 4RGB LEDs show white color slow breathing.
- Factory Default Resetting: 4RGB LEDs show white constant with fade in 0.5s.
- Waiting for hotword trigger: 4RGB led light off.
- Hotword triggered: refer to UX google assistant animations.
- During saying voice command: refer to UX google assistant animations.
- Process result of voice command; refer to UX google assistant animations.
- Provide result of voice command: refer to UX google assistant animations.
- Command time out: 4RGB led fast breathing 3times Firmware upgrade: 4RGB led all white slow breathing.
- Reach Max volume: 4RGB all show white fast flash for two times.

⑦ Subwoofer's LED indicator

- Pairing mode: red led
- flash Connected: solid red

Remote control

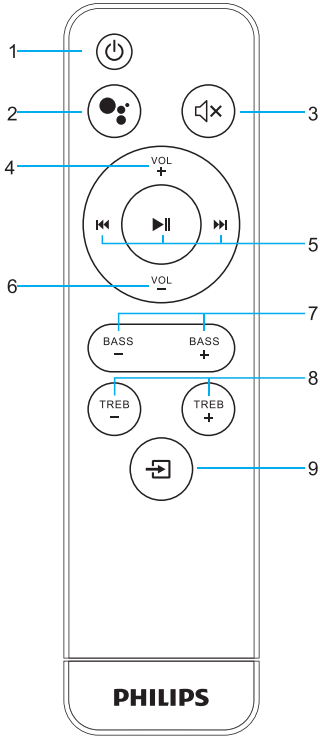

1. **Power Button**
Switches the unit between **ON** and **OFF** modes.
2. **Push to Talk**
Press to enable push to talk function.
3. **Mute Button**
Mutes the unit or resumes the sound.
4. **VOL + Button**
Increase the volume.
5. **Playback Control Buttons**
Short press to control music playback: prev, track, pause / play, next track.
6. **VOL - Button**
Decrease the volume.
7. **BASS Button**
Increase or decrease BASS volume.
8. **TREB Button**
Increase or decrease treble volume.
9. **SOURCE Button**
Short press to change source:
HDMI, BLUETOOTH, OPTICAL, AUX

Connectors

This section includes an overview of the connectors available on your SoundBar and SoundBar.

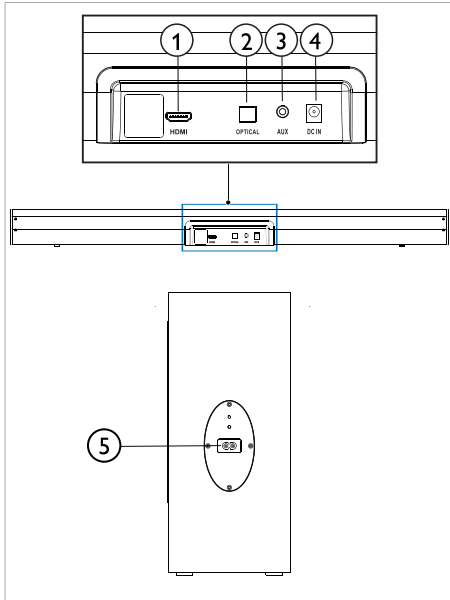

- ① **HDMI**
HDMI (ARC) Connect to HDMI ARC on the TV.
- ② **OPTICAL**
Connect to an optical audio output on the TV or a digital device.
- ③ **AUX**
Analog audio input, for example, an MP3 player (3.5mm srereo).
- ④ **DC IN**
Connect the soundbar to the power supply.
- ⑤ **AC IN**
Connect the Subwoofer to the power supply.

3 Connect

This section helps you connect your SoundBar to a TV and other devices.

For information about the basic connections of your SoundBar and accessories, see the quick start guide.

Note

- For identification and supply ratings, refer to the type plate at the back or bottom of the product.
- Before you make or change any connections, make sure that all devices are disconnected from the power outlet.

Placement

Place your SoundBar and Subwoofer as shown below.

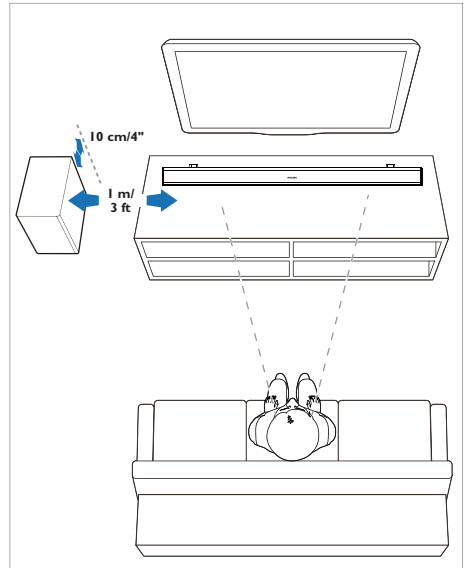

Connect the SoundBar and Subwoofer

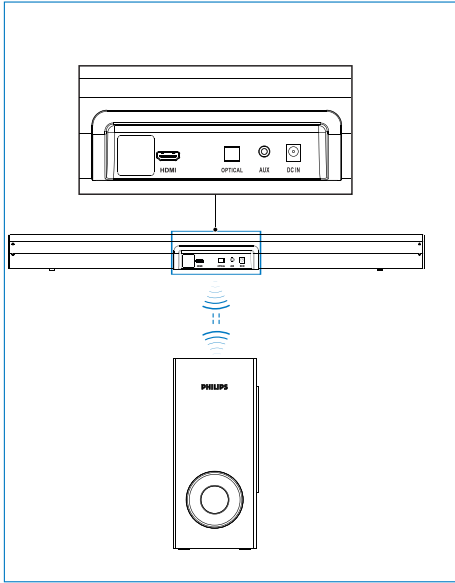

- Soundbar and subwoofer be paired in factory default setting, when unit power on, will be connected automatically in few seconds; if cannot be connected in 10s, subwoofer's red led will be slow blinking until them be paired.
- If subwoofer and soundbar is disconnected somehow(lose power etc), it will always automatically reconnect , when unit still stay unconnected state, please goes to manual pair.

Pair the Subwoofer manually

- Once subwoofer cannot be connected to soundbar automatically, user can pair them manually by following below process. Long press source and vol+ button at same time on soundbar for 3s, and then long press pairing button on subwoofer for 3s, Soundbar's current LED indicator and subwoofer's red led will fast blink until be paired each other. After connected, led indicator stay solid bright.

Connect audio from TV and other devices

Option 1: Connect audio through a HDMI cable

Best quality audio

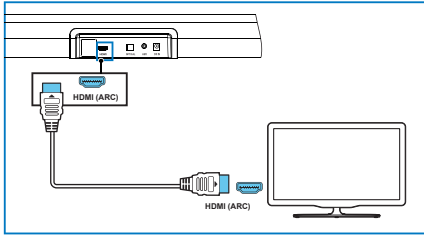

- Using a HDMI cable connect the **HDMI** connector on your SoundBar to the **HDMI OUT** or other device.

Option 2: Connect audio through a digital optical cable

Best quality audio

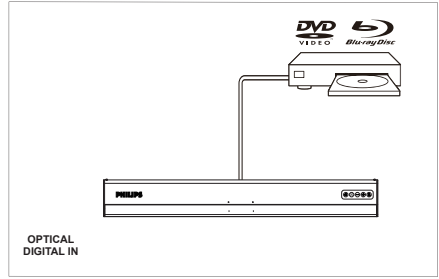
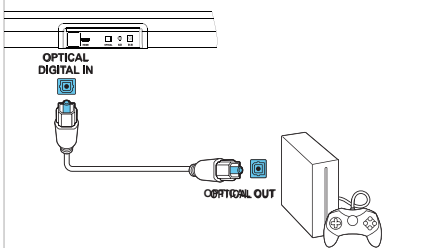
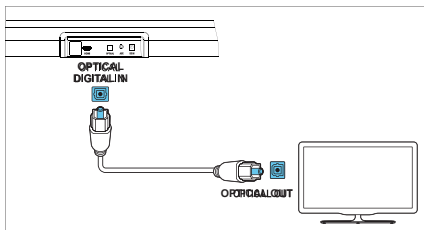

- Using an optical cable, connect the **OPTICAL** connector on your SoundBar to the **OPTICAL OUT** connector on the TV or other device.
 - The digital optical connector might be labeled **SPDIF** or **SPDIF OUT**.

Option 3: Connect audio through a 3.5mm stereo audio cable

Basic quality audio

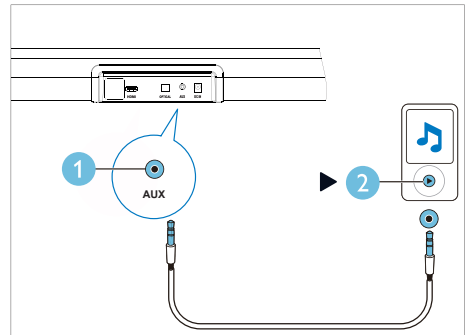
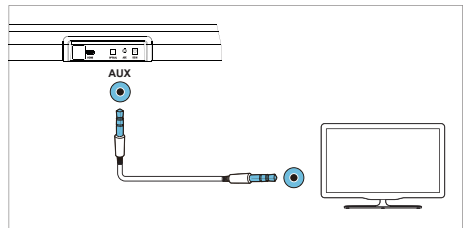

- Using a 3.5mm stereo audio cable, connect the **AUX** connector on your SoundBar to the **AUX** connector on the TV or other device.

4 Use your SoundBar

This section helps you use the SoundBar to play audio from connected devices.

Before you start

- Make the necessary connections described in the Quick Start Guide or download the User Manual from www.philips.com/support.
- Switch the SoundBar to the correct source for other devices.

Adjust the volume

1 Press +/- (**Volume**) to increase or decrease a volume level.

- To mute sound, press **MUTE**.
- To restore the sound, press **MUTE** again or press +/- (**Volume**).

Volume level status:



- One of four RGB led lit up from dim to solid brightness when volume level at 25% in 0.5s.



- Two of Four RGB leds lit up when volume level at 50% in 0.5s, 1st LED keep solid, but 2nd LED will lit up from dim to solid brightness.



- Three of Four RGB leds lit up when volume level at 75% in 0.5s, the first two LED keep solid, but 3rd LED will lit up from dim to solid brightness.



- Four RGB leds lit up in Max. volume in 0.5s, 3 LEDs keep solid, but 4th LED will lit up from dim to solid brightness.

MP3 player

Connect your MP3 player to play your audio files or music.

What you need

- An MP3 player.
 - A 3.5mm stereo audio cable.
- 1 Using the 3.5mm stereo audio cable, connector the MP3 player to the **AUX** connector on your SoundBar.
 - 2 Press **MP3** on the remote control to select **AUX** mode.
 - 3 Press the buttons on the MP3 player to select and play audio files or music.

TV play

Connect your TV to play audio files or music.

What you need

- A TV with HDMI connector.
- A HDMI audio cable.



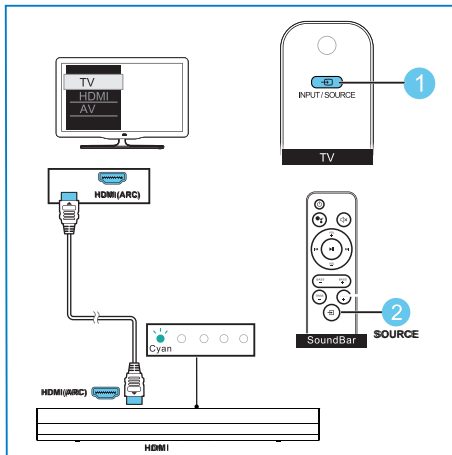

- 1 Using HDMI cable, connect TV to the HDMI connector on your SoundBar.
- 2 Press INPUT/SOURCE on your TV remote control to select HDMI mode.
- 3 Press SOURCE on the SoundBar remote to select HDMI mode.



Play audio through Bluetooth



Through Bluetooth, connect the SoundBar with your Bluetooth device (such as an iPad, iPhone, iPod touch, Android phone, or laptop), and then you can listen to the audio files stored on the device through your SoundBar speakers.

What you need

- A Bluetooth device which supports Bluetooth profile A2DP and AVRCP, and with Bluetooth version as 4.2.
 - The operational range between the SoundBar and a Bluetooth device is approximately 4 meters (13 feet).
- 1 Press  on the remote control to switch the SoundBar to select **Bluetooth** mode.
 - ↳ The soundbar's indicator blinks blue.
 - 2 On the Bluetooth device, switch on Bluetooth, search for and select **Philips TAPB405** to start connection (see the user manual of the Bluetooth device on how to enable Bluetooth).
 - ↳ During connection, the soundbar's indicator blinks blue.
 - 3 Wait until the soundbar's indicator becomes solid blue.
 - ↳ If the connection fails, the indicator blinks continually at a lower rate.
 - 4 Select and play audio files or music on your Bluetooth device.
 - During play, if a call is coming, music play is paused.
 - If your Bluetooth device supports AVRCP profile, on the remote control you can press  /  to skip to a track or press  to pause/resume play.
 - 5 To exit Bluetooth, select other source.
 - When you switch back to Bluetooth mode, Bluetooth connection remains active.



Note

- The music streaming may be interrupted by obstacles between the device and SoundBar, such as wall, metallic casing that covers the device, or other devices nearby that operate in the same frequency.
- If you want to connect your SoundBar with another Bluetooth device, press  on the remote control to select Bluetooth mode and hold  to disconnect the currently connected Bluetooth device.

Google Voice Assistant

Just start with "OK Google", then ask it questions or tell it to do things like this:

"Play some jazz"

"Turn up the volume"

"Set a 13 minute timer for pizza"

"Do I need an umbrella today?"

Google Chromecast Built-in

Follow the three steps below to enjoy this feature:

1. Connect a phone or tablet to the same Wi-Fi network as your speaker using the Google Home App.
2. Cast podcasts, music, and more from 100+ Chromecast-enabled apps. Tap the Cast button in a Chromecast-enabled app to play.
3. Tap the Cast button in a Chromecast-enabled app to play music on your speaker.

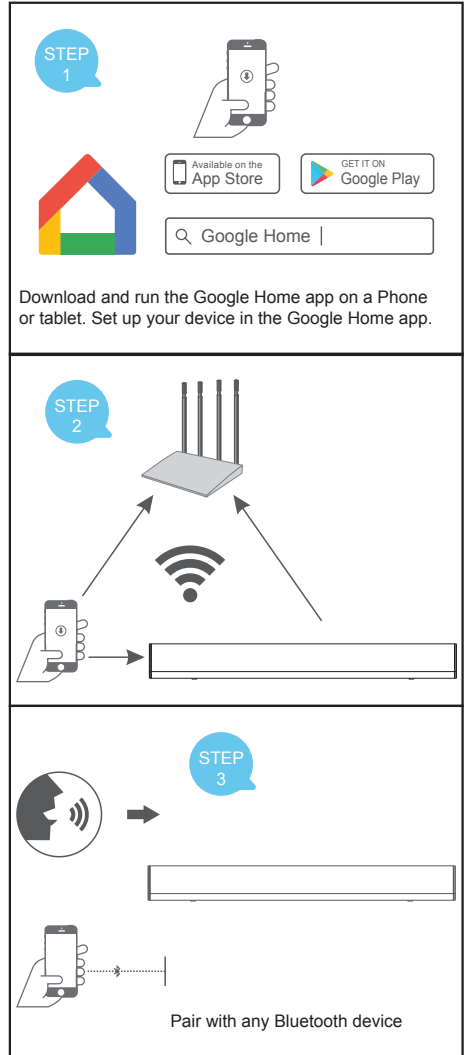

AirPlay 2

To control this AirPlay 2-enabled speaker, iOS 11.4 or later is required on your device.

Set up your device in the Apple Home app located on your iPhone or iPad

1. Connect your iOS device to the WiFi.
2. Follow the Apple Home app configure process.
 - I Open Apple Home app.
 - II Click the "+" icon, select "Add Accessory".
 - III Click "Don't Have a Code or Can't Scan".
 - IV Search the device and when you find the device, click the device name.
 - V When prompted "Add Accessory to Network" click Allow.
 - VI Waiting for network connection.
 - VII After networking successfully, Accessory Added.
 - VIII Go to My Home, you can find there has a new device that you added.

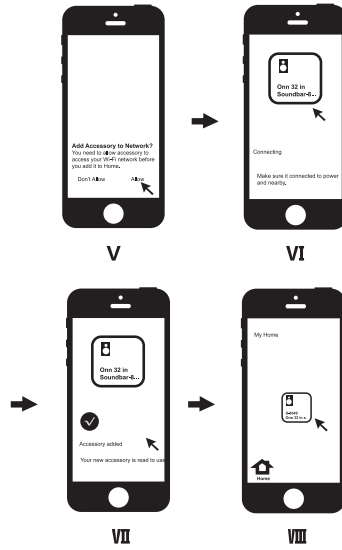
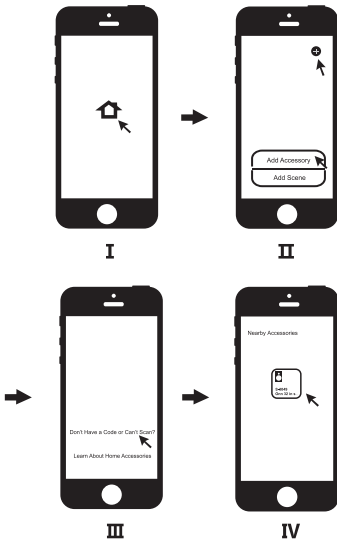

3. When Soundbar has connected to the network, AirPlay music to Soundbar:
 - I Select one music player, such as Apple music app, Click the AirPlay icon.
 - II Select the device name and click to connect, Play control when casting, like volume down/up, play/pause, prev/next etc.

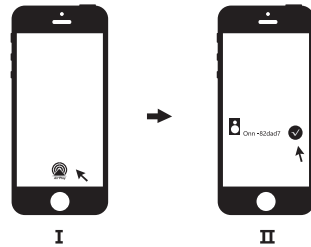

Use of the Works with Apple badge means that an accessory has been designed to work specifically with the technology identified in the badge and has been certified by the developer to meet Apple performance standards.

Apply factory settings

When the speaker power on, hold the VOL- and VOL+ button for 15s, the speaker will power off by itself and reset factory default settings.

5 Wall mount

Note

- Improper wall mounting may result in accident, injury or damage. If you have any query, contact Consumer Care in your country.
- Before wall mounting, make sure the wall can support the weight of your SoundBar.

Screw length/diameter

Depending on the type of wall mounting your SoundBar; make sure that you use screws of a suitable length and diameter.

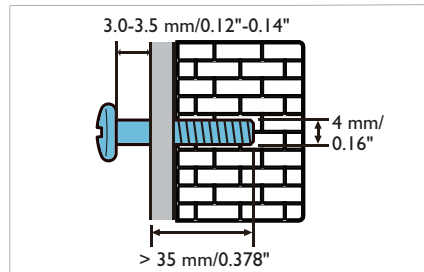

See the illustration in the quick start guide on how to wall mount the SoundBar

- 1) Drill two holes on the wall.
- 2) Secure the dowels and screws in the holes.
- 3) Hang the SoundBar on the fastening screws.

6 Product specifications



Note

- Specifications and design are subject to change without notice.

Amplifier

- RMS total output power: 120 W RMS
- Frequency response: 50 Hz-20 kHz / - 6 dB
- Signal-to-noise ratio:
> 88 dB (CCIR) / (A-weighted)
- Total Harmonic Distortion: < 1 %
- Input sensitivity:
 - LINE IN: 500 mV +/- 50 mV

Audio

- S/PDIF Digital audio input:
 - Optical: TOSLINK
- Sampling frequency:
 - MP3: 8 kHz, 11 kHz, 12 kHz, 16 kHz, 22 kHz, 24 kHz, 32 kHz, 44.1 kHz, 48 kHz
- Constant bit rate:
 - MP3: 8 kbps - 320 kbps

Bluetooth

- Bluetooth profiles: A2DP, AVRCP
- Bluetooth version: 4.2
- Frequency band/Output power:
2402 - 2480 MHz / ≤ 12 dBm

Main unit

Soundbar

- Power supply: 100-240 V~, 50/60 Hz
- Power consumption: 18 W/2 A
- Standby power consumption: ≤ 2.5 W
- Dimensions (W x H x D):
800 x 67.5 x 107 mm
- Weight: 2.09 kg
- **Built-in speakers:** 2 x full range (57 mm/2.25", 6 ohm)
2 x tweeter (19.05 mm/0.75", 6 ohm)

Subwoofer

- Power supply: 100-240 V~, 50/60 Hz
- Power consumption: 60 W
- Standby power consumption: ≤ 2 W
- Dimensions (W x H x D):
300 x 343 x 150 mm
- Weight: 5.08 kg
- **Built-in speakers:** 1 x frequency (133 mm/5.25", 4 ohm)

Remote control batteries

- 2 x AAA-R03-1.5 V

TAPB405 is in compliance with the European Union energy legislation.

TAPB405 complies with European Commission Regulation (EC) No 1275/2008 and (EU) No 801/2013 as a networked equipment with high network availability (HiNA equipment and equipment with HiNA functionality).

Power consumption

Standby: N/A

Network Standby: N/A

Active Standby*: 3W

* **Active Standby:** TAPB405 is connected to a wireless network but does not provide active audio functions.

7 Troubleshooting



Warning

- Risk of electric shock Never remove the casing of the product.

To keep the warranty valid, never try to repair the product yourself.

If you have problems using this product, check the following points before you request service. If you still have a problem, get support at www.philips.com/support.

Main unit

The buttons on the SoundBar do not work.

- Disconnect the SoundBar from the power supply for a few minutes, then reconnect.

Sound

No sound from SoundBar speakers.

- Connect the audio cable from your SoundBar to your TV or other devices.
- Reset your SoundBar to its factory settings.
- On the remote control, select the correct audio input.
- Make sure that the SoundBar is not muted.

Distorted sound or echo.

- If you play audio from the TV through the SoundBar, make sure that the TV is muted.

Bluetooth

A device cannot connect with the SoundBar.

- The device does not support the compatible profiles required for the SoundBar.
- You have not enabled the Bluetooth function of the device. See the user manual of the device on how to enable the function.
- The device is not correctly connected. Connect the device correctly. (see 'Play

audio through Bluetooth' on page 10)

- The SoundBar is already connected with another Bluetooth device. Disconnect the connected device, then try again.

Quality of audio play from a connected Bluetooth device is poor.

- The Bluetooth reception is poor Move the device closer to the SoundBar, or remove any obstacle between the device and the SoundBar.

The connected Bluetooth device connects and disconnects constantly.

- The Bluetooth reception is poor Move the device closer to the SoundBar, or remove any obstacle between the device and the SoundBar.
- Turn off Wi-Fi function on the Bluetooth device to avoid interference.
- For some Bluetooth, the Bluetooth connection can be deactivated automatically to save power. This does not indicate any malfunction of the SoundBar.



The Bluetooth® word mark and logos are registered trademarks owned by Bluetooth SIG, Inc.

Google, Google Home, Google Play, Chromecast Built-in, and other related marks and logos are trademarks of Google LLC. Manufactured under license from Dolby Laboratories. Dolby, Dolby Audio, and the double-D symbol are trademarks of Dolby Laboratories.

Apple and AirPlay are trademarks of Apple Inc., registered in the U.S. and other countries.

The Adopted Trademarks HDMI, HDMI High-Definition Multimedia Interface, and the HDMI Logo are trademarks or registered trademarks of HDMI Licensing Administrator, Inc. in the United States and other countries.

Specifications are subject to change without notice.

Philips and Philips Shield Emblem are registered trademarks of Koninklijke Philips N.V. and are used under license. This product has been manufactured by and is sold under the responsibility of MMD Hong Kong Holding Limited, or one of its affiliates, and MMD Hong Kong Holding Limited is the warrantor in relation to this product.

