

BougeRV

User Manual

**MPPT NEGATIVE GROUND
SOLAR CHARGE CONTROLLER**



www.bougeRV.com



Content

Safety Instructions	2
Features	3
Warranty	4
Identification Of Parts	5
LCD Display Parameter	5
Controller Key Operation	6
System Wiring	6
Wiring Instructions	7
APP Operating Instructions	8
APP Operating	9
APP Main Interface	10
Lead-acid Battery Working Stage	11
Lithium Battery Working Stage	11
Error Code	12
LED Signal Instruction	12
Base Specification	13
Battery Charge Parameter	14
Controller Dimension	15
FAQ	17



Safety Instructions



Please follow the safety instructions for operation, the damage caused by not following the safety instructions shall be borne by the individual.

Please save these instructions

If you need to use the PDF version of the manual, you can contact us:
service@bougerv.com.

General Safety Information

1. Read all of the instructions and cautions in the manual before installation.
2. There are no repairable parts for this controller, do not disassemble or attempt to repair the controller.
3. Keep the controller from the water.
4. Make sure all connections with controller are tight.

Charge Controller Safety

1. NEVER connect the solar panel array to the controller without a battery. The battery must be connected first.
2. Ensure input voltage does not exceed 150 VDC to prevent permanent damage.
3. Ensure that the output current of the solar panel does not exceed the rated charging current of the controller.

Battery Safety

1. Do NOT let the positive (+) and negative (-) terminals of the battery touch each other.
2. Explosive battery gases may be present while charging. Be certain there is enough ventilation to release the gases.
3. Be careful when working with large lead-acid batteries. Wear goggles and have fresh water available in case there is contact with the battery acid.
4. Over-charging and excessive gas precipitation may damage the battery plates and activate material shedding on them. Too high of an equalizing charge or too long of one may cause damage. Please carefully review the specific requirements of the battery used in the system.

Features

1. Aluminum shell and tempered glass cover, the controller has good heat dissipation effect.
2. Built-in BT communication module mobile phone APP operation (Android and IOS).
3. Filled with silicon/polyurethane inside for better cooling and waterproofing.
4. Compatible with lead-acid batteries and lithium batteries, support 12V/24V/36V/48V battery system(20A controller only support 12V and 24V), and can automatically identify the voltage of lead-acid batteries.
5. Backlit display on the screen, touch button operation.
6. Built-in reverse connection protection, open circuit protection, high temperature protection, over current/short circuit protection, all of which are self-healing, no damage to the controller.

Warranty

BougeRV provides 1-on-1 Solar Solution.

If you have any questions during use, please feel free to contact us:



service@bougeRV.com



1-408-656-8402



WhatsApp

1-669-232-7427



www.bougeRV.com

If you have some problems in the process of using the controller, please send the following information to the email: **service@bougeRV.com**

(1) The connection method of the solar panels (series/parallel, quantity, voltage, power).

(2)The voltage and battery type of the battery.

(3)The pictures or videos of the controller: battery voltage, battery charging current, the output voltage of the solar panel.

Identification Of Parts

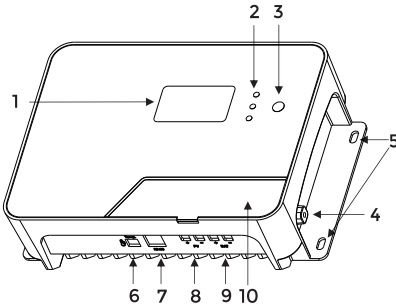

- 1 - LCD Display Screen
- 2 - LED Indicator (PV, BAT, FAULT)
- 3 - Touch Screen Button
- 4 - Grounded Terminal
- 5 - Installation Mounting Holes
- 6 - External Temperature Sensor Port
- 7 - RS485 Communication Port
- 8 - Solar Input Terminals
- 9 - Battery Terminals
- 10 - Magnetic Cover

LCD Display Interface

Main Menu Interface



Setting Battery Mode

Battery Type	Description	NOTE
FLD	Flooded Lead Acid battery	Parameters set on default, not adjustable. Battery system voltage automatically recognized.
SEL	Sealed Lead Acid battery (SLD/AGM)	
GEL	Gel Battery	

LCD Display Setting

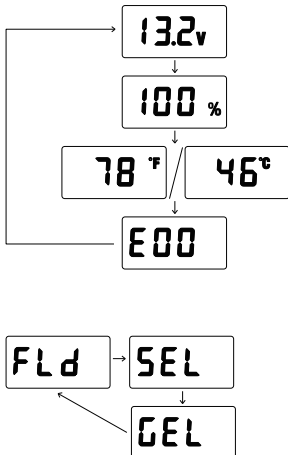

13.2v Battery Voltage

100 % Battery SOC

Temperature

(Enter the temperature sub-menu, press and hold the button for more than 2s to make the button parameters flash, short press to adjust Celsius/Fahrenheit), Finally, long press to save the parameters.

46 °C

78 °F

E00 Error Code

NOTE:①The above lead-acid battery types can be adjusted through the buttons of the controller, and the default system voltage is automatically recognized.

②Lithium battery and user battery type can only be set through APP, system voltage needs to be adjusted manually, and some parameters can be adjusted.

Controller Key Operation

1. Short press the button to switch the sub-menu, long press the button for more than 2 seconds to enter the setting mode, and the parameter flashes and short press the button to set the parameter. After the setting is completed, long press the button for more than 2 seconds, which means the parameter setting is successful.

2. In the current menu, press and hold any one of the three interfaces of [Battery Voltage], [Battery SOC], and [Error Code] to enter the battery type setting. (Only lead-acid battery type can be set)

Users need to select USE or LI battery mode, and they can only operate through APP.

System Wiring

1. The positive and negative poles of the battery must be connected to the battery terminals of the controller first.

2. Connect the positive and negative poles of the solar panel to the PV terminals of the controller.

3. Make sure that the Bluetooth of the mobile phone is turned on, and open the APP "ChargePro 2.0" to enter the setting interface.

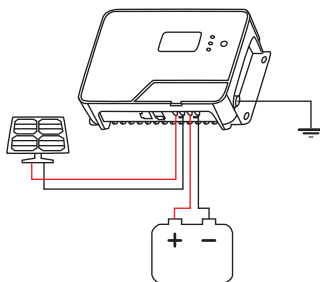

Note: Please strictly follow the above sequence for connection, otherwise the controller may be damaged. The disassembly sequence is opposite to the wiring one.

Caution

1. First make sure your battery system is 12V/24V/36V/48V(20A only support 12V and 24V).(Lead-acid batteries can automatically identify the battery voltage, if you use lithium batteries, you must manually adjust the voltage to ensure that the battery voltage is consistent with the system voltage)
- 2.Ensure that the maximum open-circuit voltage of the solar system does not exceed 150V.
3. Ensure that the maximum output current of the solar panel does not exceed the rated current.
4. Ensure that the voltage of the solar panel is higher than the battery voltage.

Wiring Instructions

1

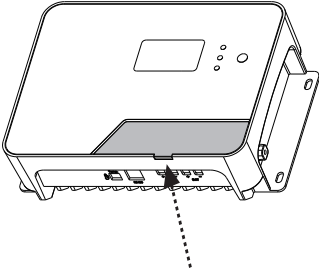

1.Remove the magnetic cover.(Pick up)

2

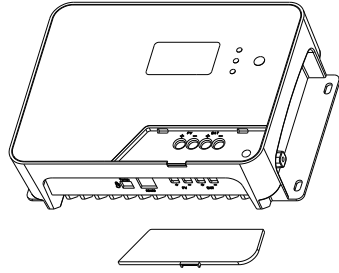

2.Put the magnetic cover aside.

3

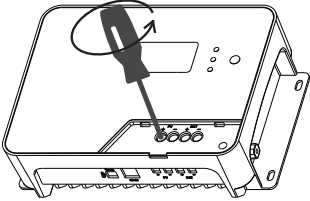

3.Unscrew the screws. (Counterclockwise)

4

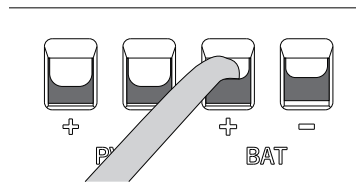

4.Plug the cable into the correct port.

5

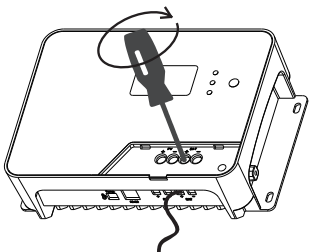

5. Tighten the screws. (Clockwise)

6

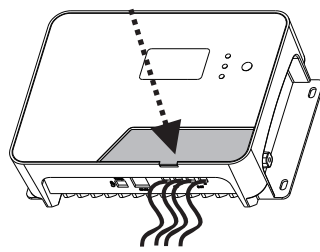

6.Check the wiring condition and put the magnetic cover back.

APP Operating Instructions

1. Scan the QR code on the right to download the application;



Android



IOS

2. Search for "**ChargePro 2.0**" in the APP Store (for IOS devices) or Google Play (for Android devices).

3. Scan the QR code on the right to view the APP teaching video and detailed electronic manual.



APP teaching video







Manual

Precautions For Using APP

1. The Bluetooth function of the mobile phone is available and turned on.
2. The GPS function is available and turned on in your phone.
3. Android firmware 5.0 and above, or IOS firmware 9.0 and above.

APP operation

1. Click the "BT icon" in the upper right corner to search for the BT device "PVChargePro".
2. Click the "menu"  in the upper left corner to check whether BT is connected.
3. Click "Parameter Setting"  in the bottom right corner to set the parameters.
4. Click the "unlocked"  lock shape icon to confirm the unlocking for parameter setting.
 - ① Select the battery type, (FLD, SEL, GEL) battery do not need to set other parameters because the voltage is automatically identified by default, and other parameters are in accordance with the default values.
 - ② Select LI, you need to manually click the system voltage to set the voltage, other parameters are recommended to follow the default value (the boost charge voltage is allowed to set).
 - ③ Select USE, you can set all parameters.
5. Click to confirm after setting the above parameters.
6. The "Real-Time Monitoring"  can check the real-time working status of the solar system, and the "Historical Data"  can check the historical working status of the solar system.

APP main interface

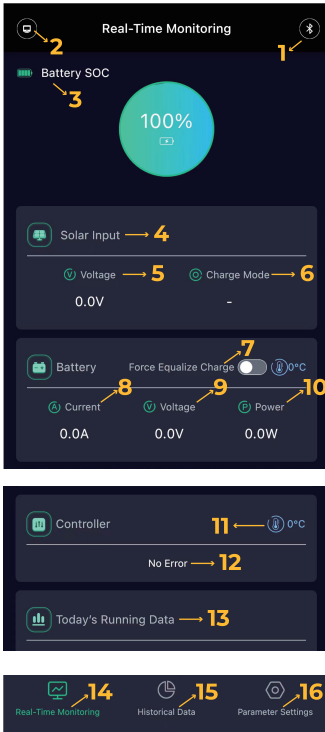

NO	Item	Description
1	BT connection	Mobile phone BT connection controller
2	Device Information	Check the BT connection status and modify the display font size
3	Battery SOC Information	Display the present battery capacity
4	Solar Input Information	
5	PV Voltage	Real-time output voltage of solar panel
6	Charge Mode	Display the present charge mode: MPPT (Buck) / Boost / Float / Equalize
7	Equalization charge	If equalization charging is turned on, charge according to the default equalization charging method; If equalization charging is turned off, you need to disconnect the solar panel and battery, disconnect the Bluetooth device and finally reconnect to restore the off state
8	Battery Charge Current	Display the real-time charging current of the battery
9	Battery Voltage	Display the real-time voltage of the battery
10	Battery Charge Power	Display the present battery charge power
11	Controller Temperature	
12	Controller Error Info	See the error code introduction in the manual
13	Today's Running Data	Display system working status at present
14	Real-Time Monitoring	Check the real-time working status of the solar system
15	Historical Data	Check the historical working status of the solar system
16	Parameter Setting	Set the charging parameters of the solar panel to the battery

Lead-acid Battery Working Stage

- ① **Bulk Charge:** Constant current charging, providing the maximum current to the battery until the battery voltage reaches the constant voltage stage (boost charging voltage or equalize charging voltage).
- ② **Boost Charge:** Constant voltage charging, the battery is charged for 120 minutes at an elevated charging voltage.

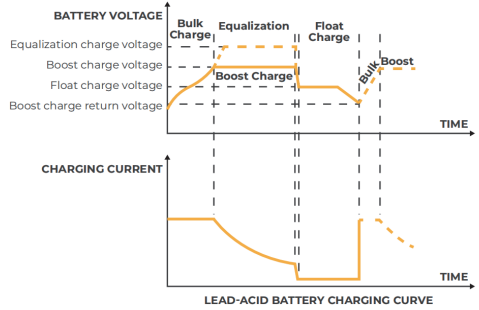

③ **Float Charge:** After the boost charge, the controller will reduce the battery voltage by reducing the charging current, and let the battery voltage be maintained at the set value of the floating charge voltage. During the floating charge stage, the battery is charged very weakly to ensure that the battery is maintained in a fully charged state. In the floating charge stage, the load can obtain nearly all solar power. If the load exceeds the power that solar energy can provide, the controller will not be able to maintain the battery voltage at the floating charge stage. When the battery voltage is low to the set value of boost charge return voltage, the system will exit the floating charging stage and enter the bulk charging stage again.

④ **Equalization:** Equalization charging raises the battery voltage to higher than the standard supplementary voltage to charge the battery. Certain types of lead-acid batteries benefit from regular equalization charging, which can agitate the electrolyte, balance the battery voltage, complete a chemical reaction, and prevent battery vulcanization.

Note: Only FLD, SLD and AGM can perform equalization charging. The equalization charge will be carried out every 30 days, and the charge time is 120 minutes. When the battery is charged in equalization, the boost charge stage will not be performed.

Lithium Battery Working Stage

① **Bulk Charge:** Constant current charging, providing the maximum current to the battery until the battery reaches the boost charge voltage.

② **Boost Charge:** Charge with a constant voltage. When it is about to be fully charged, the charging current begins to drop, and finally charges with a small current. During this process, the charging voltage is constant to maintain the boost charge voltage.

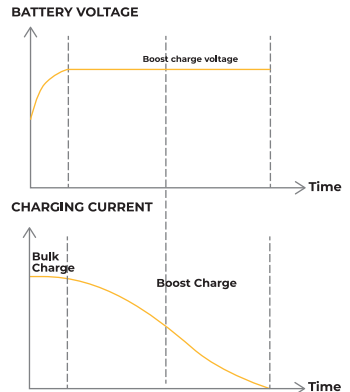

LITHIUM BATTERY CHARGING CURVE

Error Code

Error code	Cause of failure	Solution
E00	No Error	/
E02	The battery voltage is higher than the system voltage	The battery voltage drops to the return value.
E06	The controller temperature is too high	The temperature drops to the return value
E07	The ambient temperature is too high	Disconnect the controller and lower the ambient temperature
E10	The input voltage of the solar panel is too high, exceeding 150V	Change the solar panel series-parallel connection, the solar panel is connected in parallel, and the voltage is lower than 150V to recover.
E13	The positive and negative connections of the solar panel are reversed	Disconnect and reconnect with correct wire polarity.
E14	The positive and negative connections of the battery are reversed	Disconnect and reconnect with correct wire polarity.

LED Signal Instruction

LED NAME	LED Color	LED Display	Signal Indication
PV	Green	Off	Not In Charge
		Steady On	In Charge
BAT	Green	Fast Flash	Battery Over Voltage
		Steady On	Battery On & Normal
FAULT	Red	Off	No Error or Alarm
		Steady On	System with Error or Alarm



Base Specification

Model	MS2420N	MS4840N
System voltage:	12V/24V Auto (FLD/GEL/SEL)	12V/24V/36V/48V Manual (Li/User)
Rated charging current:	20A	40A
Maximum PV input voltage:	100V	150V
Maximum input of PV system:	300W/12V; 600W/24V;	600W/12V; 1200W/24V; 1800W/36V; 2400W/48V;
Communication function:	APP	
No-load loss:	12ma (12V),10ma(24V)6ma(36V),3ma(48V)	
Working temperature:	-35°C ~ +45°C/-31°F ~113°F	
Protection level:	IP34	
Altitude:	≤3000m	
Net weight:	2.2 lbs 1kg	4.6 lbs 2.1kg
Dimensions:	7.5*4.9*2.4inch 190*125*60mm	8.6*5.9*2.6 (inch) 218*150*65mm
Installation size:	7.1*3.1inch 180*80mm	8.1*2.4(inch) 205*60mm
Installation aperture:	ϕ 0.2(inch) 5mm	

Battery Charge Parameter

Battery Types	FLD	SEL	GEL	USER	LI
Equalizing Charge Voltage	14.8V*n	14.6V*n	-	Default: GEL	-
Boost Charge Voltage	14.6V*n	14.4V*n	14.2V*n	Default: GEL	Default: 14.2V*n
Floating Charge Voltage	13.8V*n			Default: GEL	-
Boost Charge Return Voltage		13.2V*n		Default: GEL	-
Equalization Charge Time	2 hour	2 hour	-	Default: GEL	-
Equalizing Charge Interval	30 day	30 day	-	Default: GEL	-
Temperature Compensation	-3mV / 2V /°C			Default: GEL	-

Note:

- ① n=1 for 12V system; n=2 for 24V system; n=3 for 36V system; n=4 for 48V system;
- ② The parameters corresponding to the yellow font can be modified by APP, and the other parameters cannot be modified.

Controller Dimension

MS2420N

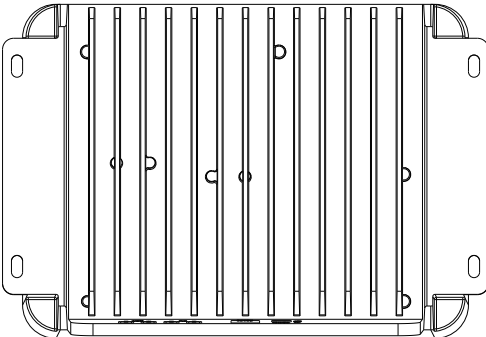
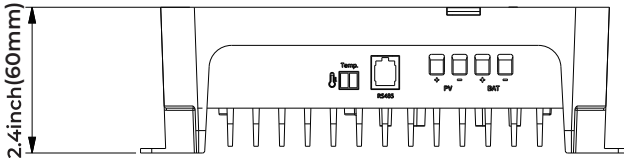
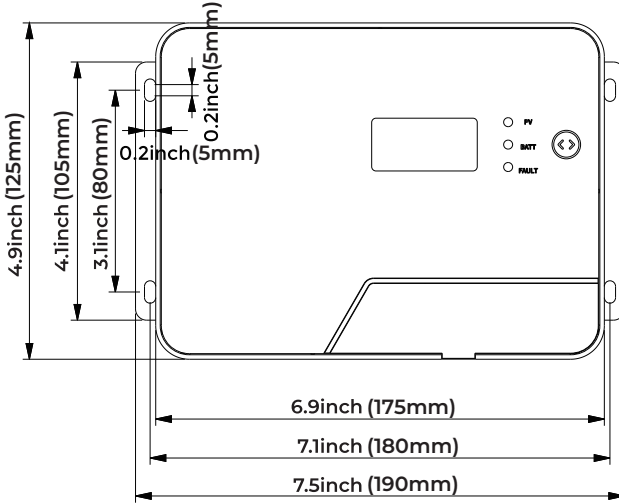

Product Dimension: 7.5*4.9*2.4inch
Installation Area Dimension: 7.1*3.1inch
Installation Hole Size: 0.2*0.2inch
Connection Socket Size: 0.3*0.3inch

Controller Dimension

MS4840N

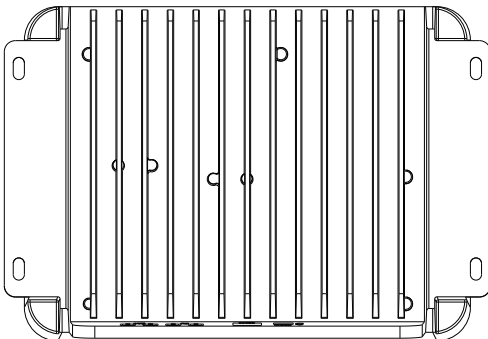
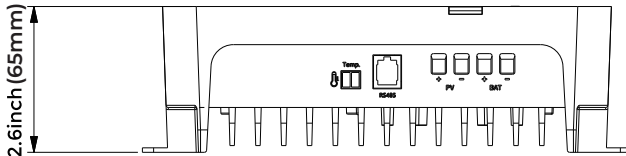
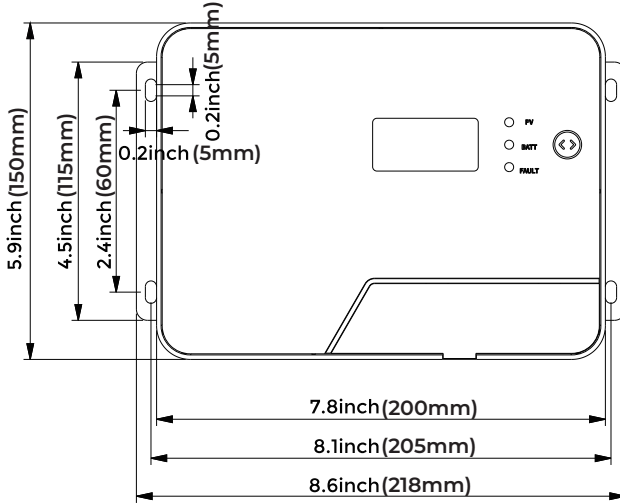

Product Dimension: 8.6*5.9*2.6inch
Installation Area Dimension: 8.1*2.4inch
Installation Hole Size: 0.2*0.2inch
Connection Socket Size: 0.3*0.3inch

Q1: What information should I provide with BougeRV to get technical support faster and better?

A1: Send the following information to the email: service@bougeRV.com, ①The connection method of the solar panels (series/parallel, quantity, voltage, power).

②The voltage and battery type of the battery.

③The display data of the controller: battery voltage, battery charging current, the output voltage of the solar panel.

④Connection from solar panel to controller and controller to the solar panel.

If the above information can be provided with pictures or videos, BougeRV can provide you with technical support faster.

Q2: Why is the battery not charging after I connected the solar panel?

A2: There may be the following reasons: the solar panel line is connected reversely, the output voltage of the solar panel is lower than the battery voltage, and the output voltage of the solar panel is greater than the maximum PV input voltage.

①Check if the polarity from the PV terminal to the controller is correct.

②Check the output voltage of the solar panel. If the output voltage of the solar panel is lower than the battery voltage, you need to connect the solar panels in series to increase the voltage; if the output voltage of the solar panel is higher than 150V, you need to reduce the output of the solar panel.

Q3: Why does the controller show that the output current is very low?

A3: ①The output current may be low due to weak light or shadows of solar panels.

②The battery may enter the float charge stage and therefore the current drops. You can use a multimeter to check the battery voltage to determine whether the battery enters the float charge stage.

Q4: What matters should be paid attention to in the daily use of the controller?

- A4:** ①Ensure that the system voltage and battery type of the controller are set correctly.
②The controller should be installed as close to the battery as possible to avoid the voltage drop caused by too long wires, which will affect the normal voltage judgment.
③The controller should be installed in a well-ventilated, non-humid environment.

Q5: What should I pay attention to when connecting to APP?

- A5:** ①Bluetooth function is available and turning on in your mobile phone.
②GPS function is available and turning on in your mobile phone.
③Android firmware version 5.0 or above, or IOS firmware version 9.0 or above.

BougeRV

✉ service@bougerv.com

☎ 1-408-656-8402

🌐 www.bougerv.com