

16 NOZZLES ESSENTIAL OSCILLATING SPRINKLER

Use this manual to familiarize yourself with the various parts and components, the use, handling and features of the sprinkler. Save this manual for future reference.

Get To Know Your Sprinkler

1. Base
2. Spray nozzles (16)
3. Oscillator tube
4. Sliding tabs
5. Hose-end
6. Inlet filter
7. Cleaning pin

Specifications

Plastic nozzle heads : 16
Adjustable range control : Yes
Coverage Max : 3600 sq ft (335 m²)
(Based on 40PSI / 2.76Bar)

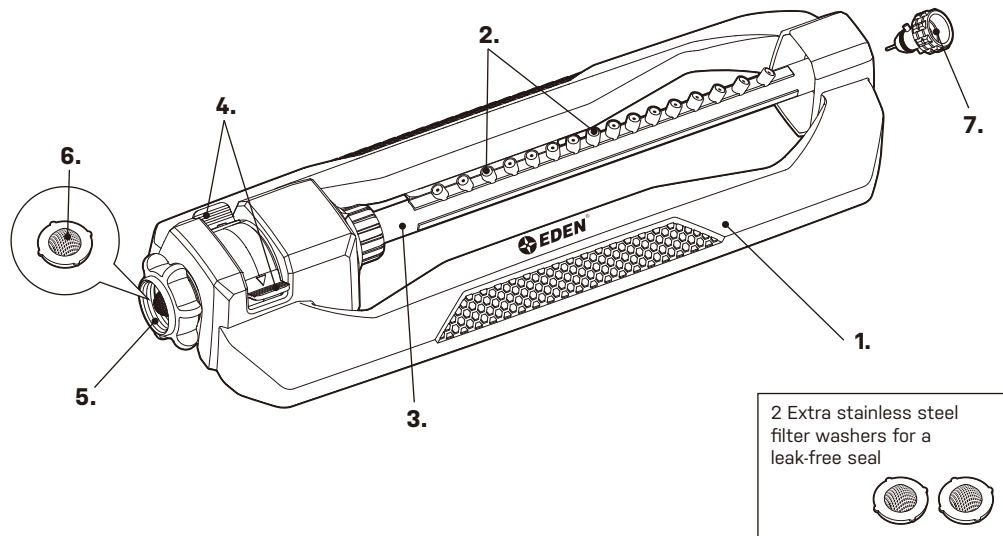

Usage

1. Attach your garden hose to the sprinkler.
2. Use the range sliding tabs to select desired rectangular watering distance. (Fig 1 & Fig 2)
3. Turn on the faucet and check to see how the process is working. Make adjustments to suit your needs.

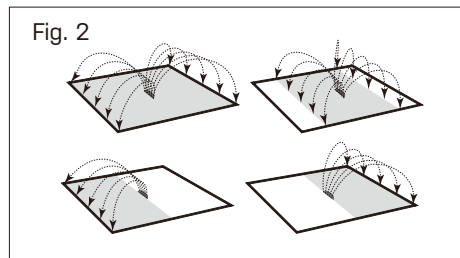
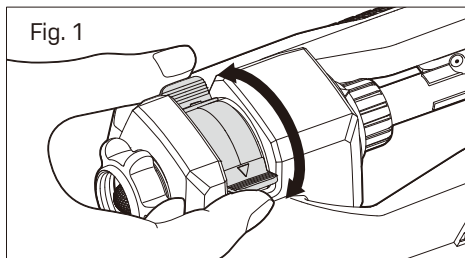

Maintenance + Care

If your sprinkler begins to display irregular water pressure or is clogged due to dirt buildup, do the following maintenance task.

1. Remove your hose from your sprinkler. Notice a small inlet filter from the hose-end of the oscillator, remove it and run under water to remove the dirt (Fig. 3).
2. To flush, connect the oscillator to a faucet. Turn on the faucet and while the water continues running, spin the tube gently back and forth for few minutes (Fig 4)

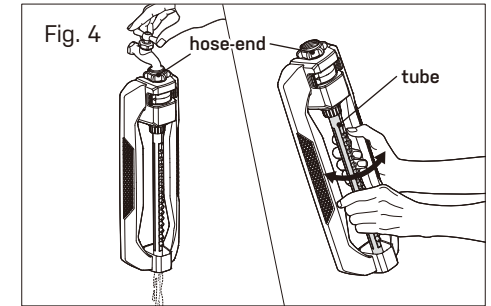
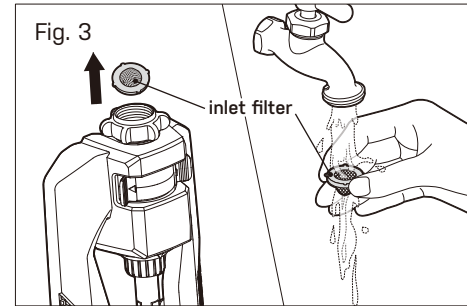

3. Remove the cleaning pin from the opposite end of the oscillator (Fig. 5).

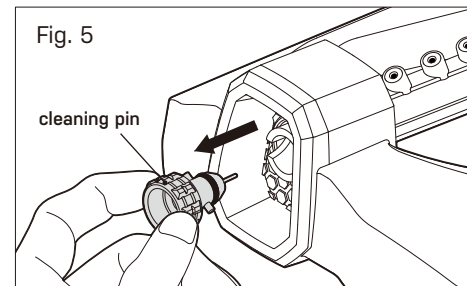

4. Use the provided cleaning pin to clear any clogs from the spray nozzles while running water in step 2 (Fig. 6).

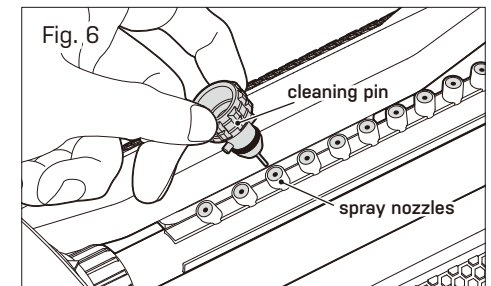

Storage

Drain the sprinkler after use. DO NOT allow water to freeze in the sprinkler (Fig. 7).

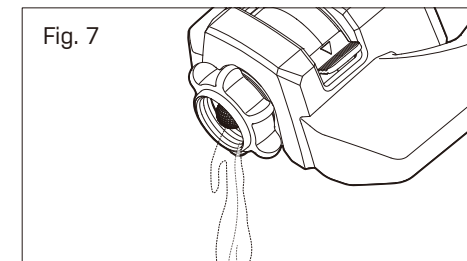

Tips

1. Think of the best coverage design for the watering without wasting water resources before placing the sprinkler in the location where you want to water.
2. Drain any water from the sprinkler after use. This will preserve the unit for longer lasting use.
3. Place the sprinkler in a dry warm storage area until it is required.
4. Water only when necessary, preferably in the morning as this will minimize water loss through evaporation. To obtain deep root growth, water deeply but do not water often. Watering every second day will provide for better water coverage. Using a timer can be helpful in reducing waste. Watch water application to avoid water run-off.

⚠ CAUTION ⚠

- For outdoor use with cold water only
- Do not spray near electrical connections
- When not in use, rinse the tool with water to remove most of the dirt, dry your tool, and store indoors

⚠ WARNING: This product can expose you to chemicals including styrene, which is known to the State of California to cause cancer. For more information go to www.P65Warnings.ca.gov

The Quick Connect Adapter (2 pcs) and Hose Connector with Water Stop (1 pc) simplify your watering experience. Simply attach the connector at the end of your hose. Then, connect the adapters to your watering tools. Interchange various tools in a snap without turning off the water as the adapter will stop the water flow. No more kinking or hose twisting as the adapter allows the hose to swivel 360 degrees.

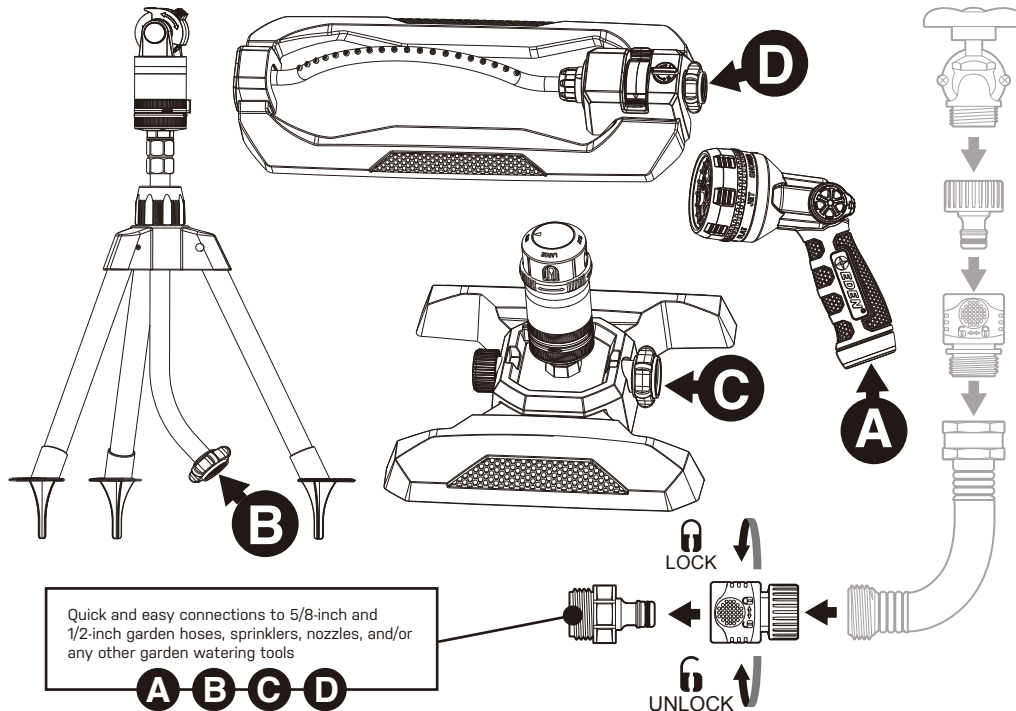
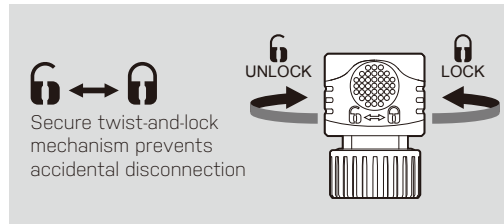

96213 EDAMZ

16 NOZZLES ESSENTIAL OSCILLATING SPRINKLER

- Coverage up to 3600 sq. ft. (335 m²) (Based on 40 PSI / 2.76 Bar)
- 16 Durable nozzles
- Sliding tabs allow for simple range adjustment
- Flexible construction won't break when stepped on
- Needle plug for nozzle cleaning