

# WFR-39

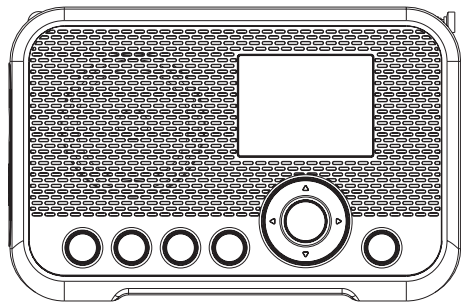

**GB**

Revision 3



## Table of Contents

<b>1. IMPORTANT SAFETY INSTRUCTIONS</b> .....	<b>03</b>
<b>2. Introduction</b> .....	<b>03-04</b>
<b>Overview of the main unit</b> .....	<b>03-04</b>
<b>3. Getting started</b> .....	<b>04-05</b>
<b>Finding a suitable location for the radio</b> .....	<b>04</b>
<b>Powering the radio</b> .....	<b>04</b>
Operation on USB power .....	04
Operation on battery power.....	04
Charging the unit.....	04
<b>Performing the radio's initial setup</b> .....	<b>04-05</b>
Setting the menu language .....	04
The mobile app's privacy policy.....	04
Configuring the network connection.....	05
<b>Turning the radio on / off</b> .....	<b>05</b>
<b>Navigating the radio menus</b> .....	<b>05</b>
<b>Controlling the radio using the AirMusic Control app</b> .....	<b>05</b>
<b>4. The configuration menu</b> .....	<b>05-07</b>
<b>5. Listening to Internet Radio</b> .....	<b>08-09</b>
<b>Tuning into internet radio stations</b> .....	<b>08</b>
Local radio menu .....	08
Internet Radio menu.....	08
<b>Storing preset / favorite internet stations</b> .....	<b>08-09</b>
<b>Recalling preset / favorite internet stations</b> .....	<b>09</b>
<b>6. Listening to podcasts</b> .....	<b>09</b>
<b>Storing preset / favorite podcasts</b> .....	<b>09</b>
<b>Recalling preset / favorite podcasts</b> .....	<b>09</b>
<b>7. Spotify Connect</b> .....	<b>09</b>
<b>8. Listening to DAB radio</b> .....	<b>09-10</b>
<b>Tuning into DAB stations</b> .....	<b>09</b>
<b>Storing preset DAB stations</b> .....	<b>09</b>
<b>Recalling preset DAB stations</b> .....	<b>10</b>
<b>9. Listening to FM radio</b> .....	<b>10</b>
<b>Tuning into FM stations</b> .....	<b>10</b>
Performing an automatic scan .....	10
Manually tuning into FM stations.....	10
<b>Storing and recalling preset FM stations</b> .....	<b>10</b>
<b>10. Listening to music using the radio's media center features</b> .....	<b>10-11</b>
<b>Podcasts</b> .....	<b>10</b>
<b>Audio playback via cloud music services</b> .....	<b>10</b>
<b>Audio playback via UPnP server</b> .....	<b>10-11</b>
Setting up a UPnP server and playing audio using Windows Media Player .....	10-11
Using UPnP server on Mac or Linux .....	11
Supported formats.....	11

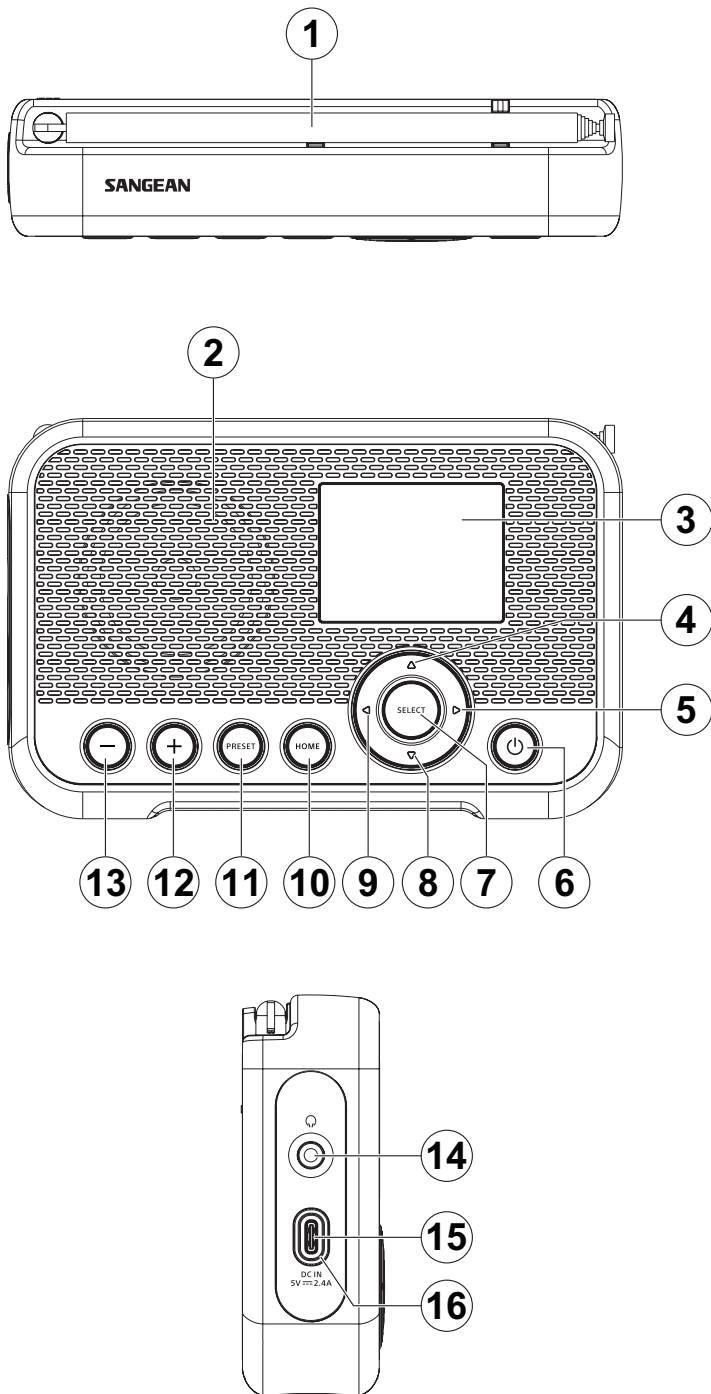
<b>11. Listening to music using the headphones jack</b> .....	<b>12</b>
<b>12. Troubleshooting</b> .....	<b>12</b>
<b>13. Specifications</b> .....	<b>13</b>



## 1. IMPORTANT SAFETY INSTRUCTIONS

1. Do not install near any heat sources such as radiators, heat registers, stoves or other apparatus (including amplifiers) that produce heat.
2. Only use attachments / accessories specified by the manufacturer.
3. To reduce the risk of fire or electric shock, do not expose this appliance to rain or moisture.
4. Apparatus shall not be exposed to dripping or splashing liquids and no objects filled with liquids, shall not be placed on the apparatus.
5. The batteries shall not be exposed to excessive heat such as sunshine, fire or the like.
6. Any changes or modifications not expressly approved by the party responsible for compliance could void the user's authority to operate the equipment and warranty.
7. **CAUTION:** Risk of explosion if the battery is replaced by an incorrect type.
8. Do not allow your radio to be exposed to water, steam or sand.
9. Do not leave your radio where   excessive heat could cause damage.
10. The following safety relevant information should be considered as applicable:

- minimum distances around the apparatus for sufficient ventilation;
  - the ventilation should not be impeded by covering the ventilation openings with items, such as newspaper, table-cloths, curtains, etc.;
  - no naked flame sources, such as lighted candles, should be placed on the apparatus;
  - attention should be drawn to the environmental aspects of battery disposal;
  - the use of apparatus in tropical and / or moderate climates.
11. **CAUTION:** Danger of explosion if battery is incorrectly replaced. Replace only with the same or equivalent type.
  12. If an apparatus is provided with a replaceable lithium battery, the following applies:
    - if the battery is intended to be replaced by the user, there shall be a warning close to the battery or in both the instruction for use and service instructions.

**Warning:** Please do not attempt to remove or replace the built-in lithium battery. Unauthorized replacements may also void the warranty.

## 2. Introduction

### Overview of the main unit

- 1 DAB / FM antenna
  - Position and extend the antenna correctly to improve the radio's DAB / FM reception.
- 2 Speaker
- 3 LCD display
- 4 Up button

- Press to navigate in the radio's menus or change the current character while inputting text.
- While in FM mode, press to increase the frequency.
- While playing from a UPnP server, press to go to the previous track.

#### 5 Right button

- Press to navigate in the radio's menus or select the next character while inputting text.
- While in FM mode, press to increase the frequency.
- While in FM mode, press and hold to automatically scan from the current frequency for a station with a higher frequency.
- While playing from a UPnP server, press to watch track cover.
- While playing from a UPnP server, press and hold to go to the next track.

#### 6 Power button

- When connected to a USB power source, press this button to turn on the radio or switch to the Standby mode.
- When not connected to a USB power source, press this button to turn the radio on or off.

#### 7 Select button

- Press the button to go forward one step in menus or to confirm the selected item.
- While in FM mode, press this button to perform an automatic scan.

#### 8 Down button

- Press to navigate in the radio's menus or change the current character while inputting text.
- While in FM mode, press to decrease the frequency.
- While playing from a UPnP server, press to go to the next track.

#### 9 Left button

- Press to navigate in the radio's menus or select the previous character while inputting text.
- While in FM mode, press to decrease the frequency.
- While in FM mode, press and hold to automatically scan from the current frequency for a station with a lower frequency.
- While playing from a UPnP server, press and hold to go to the previous track.

#### 10 Home button

- Press this button to go back to the radio's main menu.

#### 11 Preset button

- In the Internet radio, Podcast, DAB and FM modes, quickly press and release this button to go to the preset list for the selected mode.
- In the Internet radio, Podcast, DAB and FM modes, press and hold this button to save the station you are tuned into to a preset number.

#### 12 + button

- Press this button to increase the radio's volume setting.

- 13 - button
  - Press this button to decrease the radio's volume setting.
- 14 Headphones socket
  - 3.5mm socket for connecting a pair of headphones.
- 15 DC IN socket (USB Type-C)
  - Connect a USB Type-C cable to this port to power the radio and charge the battery.
- 16 Battery charging indicator
  - The Battery charging indicator will light up green when the battery is being charged and will light up red to indicate the battery is low when using battery power.

### 3. Getting started

Follow the instructions in this chapter to get your WFR-39 up and running in no time.

#### Finding a suitable location for the radio

After unpacking the radio from the box, take the following guidelines into account when finding a suitable location for the radio:

- Place the radio on a flat, even surface such as a table.
- Do not place the radio near heat sources.
- Make sure there is sufficient space available around the radio for proper ventilation.
- If you are planning to connect the radio to your Wi-Fi network, make sure to place the radio in a location where Wi-Fi reception is good.
- Avoid placing the radio near appliances that can interfere with Wi-Fi reception, such as microwaves.

#### Powering the radio

The WFR-39 can be powered using the radio's internal Lithium-ion battery or by connecting a USB power source to the radio's DC IN socket.

#### Operation on USB power

To use the radio on USB power, connect the supplied USB cable to the radio's DC IN socket and a USB power source supplying 5V / 2.4A while the radio is turned off. After connecting the cable, the radio will automatically turn on and the Battery charging indicator will light up green to indicate that the radio's battery is being charged. Press the Power button to switch the radio to the Standby mode. The radio will power off by disconnecting the radio from the USB power source when radio is in standby mode.

#### Operation on battery power

To use the radio on battery power, disconnect the USB cable, make sure the battery is charged and then press and hold the Power button. To turn off the radio, press the Power button. The radio's Battery charging indicator will light up red when the radio is low on battery. At this point the USB cable needs to be connected to recharge the internal Lithium-ion battery.

**Note:** Reduced power, distortion and a "stuttering sound" or a red battery charging indicator are all signs that the batteries need to be replaced or recharged. Instructions

on recharging the batteries can be found below.

#### Charging the unit

The WFR-39 features a built-in Lithium-ion battery that can be recharged by either using a USB charging port or a USB power adapter (not included) with a rated output of DC 5V / 2.4A.

The first time you use your WFR-39, connect it to a USB charging port or USB power adapter and fully charge the battery. While the battery is being charged, the Battery charging indicator will be solid green. After the battery is fully charged, the green Battery charging indicator will turn off.

**Note:** You can start using your WFR-39 while charging. In this case, please make sure that the USB power source provides 5V / 2.4A of electrical current. Otherwise, it may damage the USB power source.

1. Connect the supplied USB cable to the radio's DC IN socket and a USB power source supplying 5V / 2.4A.
2. When the battery is charging, the Battery charging indicator will be solid green.

When the indicator turns off, the battery is fully charged, and charging is stopped.

#### Note:

When the radio is not connected to a USB power source, the battery charging indicator will turn red to indicate the radio's battery is low. Connect the radio to a USB power source to charge it.

If the battery charging indicator turns red while the radio is connected to a USB power source, this indicates that an error is detected.

#### Performing the radio's initial setup

After the radio has been supplied with power, it will automatically turn on. "SANGEAN" will be displayed on the radio's display and a bar below this text will indicate the progress of the startup process.

Once the radio has finished starting up, it will immediately switch over to the initial setup process. During the initial setup process, the startup wizard will guide you through the configuration of the language of the on-screen menus and the network configuration of the radio.

#### Setting the menu language

Once the language selection menu appears on the display. The English language is the default language and is therefore highlighted by default. Select the desired language using the Up and Down button and confirm your choice by pressing the Select button.

#### The mobile app's privacy policy

Next, the radio will display a QR code and the URL <https://www.mediayou.net/policy.php> to direct you to the Privacy Policy.

Be sure to read this Policy before using the online functionality of the radio and only use the internet radio feature if you agree to all terms and conditions in the Privacy Policy. If you do not agree, do not use the internet radio feature and use the radio for playback in other modes instead.

Press the Select button to continue setting up the radio using the setup wizard.

## Configuring the network connection

When configuring the network connection, the first question the setup wizard will ask is whether you want it to check for network connections when you turn the radio on. There are two options here:

1. **[Yes]:** The radio will automatically scan for Wi-Fi networks when it is turned on and it is not or cannot connect to networks it has previously connected to.
2. **[No]:** The radio will not automatically scan for Wi-Fi networks when it is turned on and is not already connected to a network that it has previously connected to. In this case, you will have to connect to a network manually using the radio's menu.

Next, the wizard will ask if you want to configure the network now. There are four options to choose from here:

- (1) **[Yes]:** The radio will scan for nearby Wi-Fi networks. After scanning has completed, select your network from the list using the Up, Down and Select button and then enter the password using the Up and Down buttons to select a character, the Left and Right buttons to go to the previous or next character and Select to confirm the input. After entering the password, the radio will connect to the network. The setup wizard has now been completed and the radio will switch over to the main menu.
- (2) **[APP]:** This option will display a QR code that, when scanned, takes you to a page with instructions on how to install the AirMusic Control mobile app on your Android or iOS device and how to then connect the radio to your Wi-Fi network. Follow these instructions to successfully connect the radio to your Wi-Fi network. After the radio has been connected to the network, the setup wizard has been completed and the radio will switch over to the main menu.
- (3) **[WPS]:** If your router supports WPS (refer to the instruction manual of your router), you can also use the WPS feature to connect the radio to your Wi-Fi network. After selecting WPS, press the WPS button on your router within 120 seconds to establish a connection between the 2 devices. Once the connection is established, the setup wizard is now completed and the radio will switch over to the main menu.
- (4) **[No]:** Select no if you do not want to connect the radio to the Wi-Fi network at this point in time. When not connected to a Wi-Fi network, the radio can still be used to play FM and DAB radio. In addition, the radio can be connected to a Wi-Fi network any time by using the menu on the radio.

After finishing this step, the setup wizard is completed. The radio's time and date will automatically be set if you have connected to a Wi-Fi network, your radio is now ready for use.

## Turning the radio on / off

When the WFR-39 is turned off, simply connect it to a USB power source to turn it on. While the radio is connected to a USB power source, press the Power button to switch it to the Standby mode or disconnect it from the USB power source to turn off the radio.

To use the radio on battery power, make sure the radio is

disconnected from the USB power source and press and hold the Power button to turn on the radio. To turn off the radio, press the Power button.

**Note:** When the radio is turned on, the radio's boot up process and connecting to a Wi-Fi network can take a short period of time. After the radio has connected to a Wi-Fi network, the Wi-Fi icon on the radio's display will indicate the strength of the wireless connection.

## Navigating the radio menus

The radio's menus can be navigated using the Up, Down, Left, Right and Select buttons.

In horizontally displayed menus (such as the main menu and the menus that are displayed during the setup wizard), an item or submenu can be highlighted by pressing the Left or Right button and then pressing the Select button to confirm.

In vertically displayed menus (most other menus), the Up and Down buttons can be used to highlight an item, while pressing the Select button it can be used to confirm your choice. The Left button can now be used to go back to the previous menu and the Right button can be used to go to the next menu.

In cases where text or numbers need to be inputted, the Up and Down buttons can be used to select the required character, while the Left and Right buttons can be used to go to the previous or next character respectively.

## Controlling the radio using the AirMusic Control app

The AirMusic Control app connects the WFR-39 to your phone through a Wi-Fi network and allows you to control the radio from the palm of your hand. The app features an intuitive user interface, facilitates text input and allows you to control most of the radio features.

AirMusic Control is available for both Android and iOS and can be downloaded from Google Play or the App Store.

**Note:** In order to use the AirMusic Control app, your phone and radio must be connected to the same Wi-Fi network.

When using USB power and the DAB / FM service following function is off, or when the device is powered by battery, the Wi-Fi connection will be terminated when switching to FM or DAB mode on the radio to optimize reception. The AirMusic control app will also be disabled from controlling the radio.

## 4. The configuration menu

After completing the setup wizard and setting the location, in most cases there is no need to go back into the radio's configuration menu.

If you would like to change the location, time, the options that are displayed in the main menu or other settings, you can access the configuration menu and customize all settings to your liking.

The configuration menu can be opened by simply selecting **Configuration** in the radio's main menu.

Below is a description of all settings that can be found in the configuration menu:

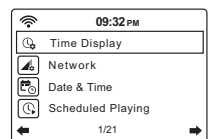

1. **[Time Display]:** Select this item to choose between digital and analog time display. If digital time display is chosen, an additional list appears for the selection of the color of the digits.

2. **[Network]:** Select this item to configure the device's network related settings. After selecting a Network, a menu appears with several new options:

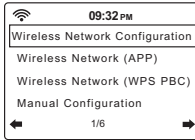

- (1) **[Wireless Network Configuration]:** Select this item and then select **[Enable]** to have the radio scan for Wi-Fi networks. After the scan has completed select a Wi-Fi network and enter the associated Wi-Fi password to connect to it.

- (2) **[Wireless Network (APP)]:** Select this item to display the QR code that guides you to a page with instructions on how to install the AirMusic Control app for Apple or Android devices and instructions on how to use this app to connect the radio to your Wi-Fi network.

- (3) **[Wireless Network (WPS PBC)]:** Select this item to connect your radio to your Wi-Fi network using the WPS feature. Before selecting this option, make sure your Wi-Fi router supports the WPS feature. Press the WPS button on the router within 120 seconds of selecting the item on the radio.

- (4) **[Manual Configuration]:** Select this item to go to a next menu with options for manually configuring and managing the radio's Wi-Fi connections. After selecting **[Wireless]**, a screen with the following options appears:

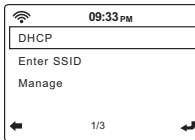

- (a) **[DHCP]:** Select this item to specify whether the radio should connect to a DHCP server on the Wi-Fi network. If DHCP (Off) is selected, you will have to manually enter an IP address on the network.
- (b) **[Enter SSID]:** Select this item to manually enter the SSID of a Wi-Fi network.
- (c) **[Manage]:** Select this item to get an overview of the Wi-Fi networks the radio has previously connected to. Wi-Fi networks and their associated passwords can be deleted from the radio's memory by selecting them and then selecting Yes.

**Note:** It is recommended not to use the Manual Configuration item unless you are familiar with computer networks.

- (5) **[Check network when Power On]:** Select this item to specify whether the radio should scan for Wi-Fi networks when it is turned on and is not or cannot connect to any known Wi-Fi network.
- (6) **[Setup PIN for APP]:** Select this item to set a PIN code that users have to input when connecting to the radio through the AirMusic Control app.
3. **[Date & Time]:** Select this item to manually configure all date and time settings. After selecting this item, a submenu containing the following items appears:

- (1) **[Set Time Format]:** Select this item to choose between the 12- and 24-hour time format.

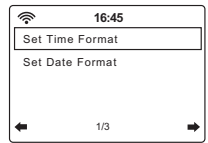

- (2) **[Set Date Format]:** Select this item to set the date format. The available options are: **YYYY / MM / DD**, **DD / MM / YYYY**, and **MM / DD / YYYY**.

4. **[Scheduled Playing]:** Select this item to have the radio play every day during a specified period. After selecting this item and then selecting **[Turn on]**, a submenu containing the following items appears:

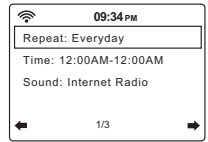

- (1) **[Repeat]:** Select this item in order to select when scheduled playing should be activated. A list of checkboxes will appear in which you can select **[Everyday]**, **[Once]**, or check / uncheck the different days of the week to customize the settings.

- (2) **[Time]:** Select this item to set the time during which scheduled playing should be active.

- (3) **[Sound]:** Select this option to choose which mode you want to use for scheduled playing.

**Note:**

When enabled, the Scheduled Playing feature will only be activated if the radio is turned on or switched to the Standby mode. It will not be activated if the radio is turned off.

5. **[Language]:** Select this item to set the language that the radio's menus are displayed in.

6. **[Dimmer]:** Select this item to configure the dimmer setting. In the menu that appears, you can either select **[Power Saving]** to change the display's brightness level or select **[Turn On]** to change the brightness level of the display in the power on mode when connected to a USB power source.

7. **[Display]:** Select this item to choose between the **[Color]** or **[Monochrome]** display mode.

8. **[Power Management]:** Select this item to set when the radio automatically powers off when being idle. The available options are: **[Turn off]**, **[5 minutes]**, **[15 minutes]**, and **[30 minutes]**.

9. **[Sleep Timer]:** Select this item to configure the sleep timer. The available options are: **[Turn off]**, **[15 minutes]**, **[30 minutes]**, **[60 minutes]**, **[90 minutes]**, **[120 minutes]**, **[150 minutes]**, and **[180 minutes]**. When a sleep timer is active, the remaining sleep time will be shown in the upper right corner of the radio's display.

10. **[DAB / FM Setup]:** Select this item to open the DAB / FM Setup submenu containing the following items:

**[FM Mode]:** Select this item to configure playback in the FM mode. Select **[Set Mono]** to force mono playback or select **[Set Stereo]** for stereo playback. Forcing mono playback can help reduce hiss from weak FM signals.

- (1) **[FM Sensitivity]:** Select this item to configure the FM radio scan sensitivity. The available options are: **[Strong]**, **[Default]**, and **[Weak]**.

(2) **[DAB Sensitivity]:** Select this item to configure the DAB radio scan sensitivity. The available options are: **[Strong]**, **[Default]**, and **[Weak]**.

(3) **[Service following (FM / Wi-Fi)]:** Select this item to enable / disable the Service following feature. This feature allows the radio to switch from an FM broadcast to an internet stream of the same broadcast when using USB power and FM reception is poor.

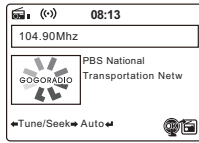

When this item is enabled, press and hold the Select button to switch from an FM broadcast to an internet stream of the same broadcast while the icon  is shown on the display.

(4) **[Service following (DAB / Wi-Fi)]:** Select this item to enable / disable the Service following feature. This feature allows the radio to switch from a DAB broadcast to an internet stream of the same broadcast when using USB power and DAB reception is poor.



When this item is enabled, press and hold the Select button to switch from a DAB broadcast to an internet stream of the same broadcast while the icon  is shown on the display.

11. **Local Radio Setup:** Select this item to go to a submenu where you can manually set up your location for Local radio or allow the radio to Auto Detect your location.

12. **Playback Setup:** Select this item to configure the repeat or shuffle mode when playing music in the Media Center mode. The available options are: **[Off]**, **[Repeat all]**, **[Repeat one]**, and **[Shuffle]**.

13. **[Equaliser]:** Select this item to select 1 of the 9 available equalizer modes. The available equalizer modes are: **[Normal]**, **[Flat]**, **[Jazz]**, **[Rock]**, **[Soundtracks]**, **[Classical]**, **[Pop]**, **[News]**, and **[my EQ]**. Select **[my EQ]** and then use the Right button to configure the bass and treble level yourself and to enable or disable the radio's loudness feature.

14. **[Resume When Power On]:** Select this item to configure whether the radio should continue playing when it is turned on. If this setting is set to **[On]**, the radio will continue playing the content it was playing from internet radio before it was turned off.

15. **[Device]:** Select this item to open the device submenu containing the following items:

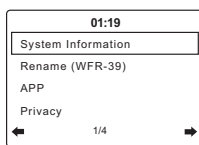

(1) **[System Information]:** Select this item to view the software version, wireless information (network status, MAC address, network SSID, IP address, Subnet, Gateway, DNS1, and DNS2).

(2) **[Rename]:** Select this item to change the name of the radio. The radio's name is used when

connecting to it using the AirMusic Control app.

(3) **[APP]:** Select this item to display a QR code that, when scanned, guides you to a page with links to the radio's companion app, AirMusic Control, in the App Store and Google Play.

(4) **[Privacy]:** Select this item to display a QR code that, when scanned, takes you to the Magic system Privacy Policy.

16. **[Software Update]:** Select this item to update the radio's software. If no updates are detected, the radio will display the message "No update available".

### VERY IMPORTANT:

When updating the radio's software, do not switch off the power to the radio until the update operation has completed and the radio has restarted, otherwise it may become permanently damaged.

17. **[Reset to Default]:** Select this item to reset the radio to the default settings. Please note that selecting this item and subsequently selecting **[Yes]** will reset the radio to its factory settings and all information stored on the radio will be deleted. This includes all settings, Wi-Fi passwords, and stored presets / favorites.

After the radio has been reset to the default settings, the radio will restart and the setup wizard will run once again to help setting up the most important radio settings.

## 5. Listening to Internet Radio

The WFR-39 is capable of receiving tens of thousands of internet stations from around the globe when the radio is connected to the internet through a Wi-Fi network.

In this chapter, you will learn how to tune to internet radio stations, how to store these stations as presets / favorite stations and how to recall preset / favorite stations.

### Tuning into internet radio stations

To tune into internet radio stations, first turn on the radio and then select **[Local Radio]** or **[Internet Radio]**. **[Local Radio]** is intended for tuning into local radio stations, while the **[Internet Radio]** submenu allows you to tune into stations from all around the world.

### Local radio menu

After selecting **[Local Radio]** from the main menu, a submenu will appear in which there are several ways of selecting a local internet radio station:

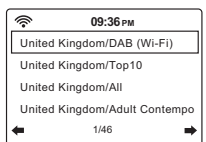

1. **[Your country / DAB (Wi-Fi)]:** Select this item to go to a list of all DAB radio stations from your country ("Germany" in the image above) that are also broadcasting their signal through the internet.

2. **[Your country / Top10]:** Select this item to go to a list with the 10 most popular internet radio stations in your country ("Germany" in the image above).

3. **[Your country / All]:** Select this item to go to a list with all internet radio station from your country ("Germany" in the image above).

4. **[Your country / Genre]:** Finally, there are still several options to go to genre-specific lists of radio stations. Simply choose the item corresponding to your favorite

genre (for example, rock) to go to a list with all internet stations in your country ("Germany" in the image above) broadcasting music of that genre.

5. More options are available by using the Down button on the radio.

To tune into a station, simply highlight it in the list and then press the Select button.

**Note:** The items in the above menu depend on your location. Due to different broadcasting systems being used around the world, European users will see the DAB (Wi-Fi) item, while users in the US and the Americas will see the HD (Wi-Fi) and / or FM (Wi-Fi) items.

**Note:** If you have not set the radio's location prior to accessing the Local Radio menu, the radio will first show the location selection menu. Use the menu to auto detect your location or to set it manually using the Left, Right, Up, Down and Select buttons.

## Internet Radio menu

The Internet Radio menu features more options than the Local Radio menu:

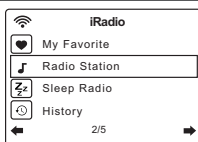

1. **[My favorite]:** Select this item to go to the list with your favorite stations. These are the presets that you've set on the radio, as well as any station that you have saved as a favorite station.

2. **[Radio Station / Music]:** Select this item to go to the submenu where you can select internet radio stations from around the globe. The following items are available in this submenu:

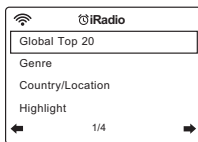

(1) **[Global Top 20]:** Select this item to go to a list of the 20 most popular internet radio stations around the globe.

(2) **[Genre]:** Select this item to search for radio stations around the world that are broadcasting a specific genre. After selecting a genre, you can browse through either the most popular stations in this genre or through the stations by country.

(3) **[Country / Location]:** Select this item to search for internet radio stations by country. After selecting a continent and country, you will be directed to the Local Radio menu (described above) for that country.

(4) **[Highlight]:** Select this item to go to a list with recommended internet radio stations.

3. **[Sleep Radio]:** Select this item to go to a list with radio stations that broadcast ambient sounds that will help you to relax or fall asleep.

4. **[History]:** Select this item to look at the history of the stations that you have tuned into.

5. **[Service]:** Select this item to go to a submenu to add new internet radio stations that might not be listed in any of the other lists or stations that you simply cannot find.

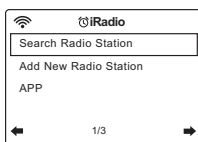

(1) **[Search Radio Station]:** Select this item to search for an internet radio station by name.

(2) **[Add New Radio Station]:** Select this item to add an internet radio station using a URL.

(3) **[APP]:** Select this item to have the radio display a QR code guiding you to the download location of the AirMusic Control app (the radio's companion app). Simply scan the QR code to go to the page with more information about the download locations for the app.

## Storing preset / favorite internet stations

The WFR-39 can store up to 250 presets / favorite stations.

To store an internet station as a preset / favorite station, follow these steps:

1. Turn on the radio.

2. Select **[Internet radio]** or **[Local Radio]** from the main menu, go to any internet radio station listed and highlight or tune into an internet station.

3. Press and hold the Preset button for 2-3 seconds then release to enter the preset setting menu, where you can use the Up, Down and Select buttons to select and confirm the required preset number.

4. Alternatively, after highlighting a radio station, you can also press the Right button and then in the next menu select the **[Add to My Favorite]** item.

5. Repeat this procedure as needed for the remaining presets.

**Note:** Presets / favorite stations that have been added to the preset / favorite list cannot be added again to a different preset / favorite number.

## Recalling presets / favorite internet stations

Preset / favorite internet stations can be recalled in two ways:

- Select **[Internet Radio]** from the radio's main menu, press the Preset button and then select the desired station using the Up, Down and Select buttons.

- Select **[Internet Radio]** from the radio's main menu, select **[My Favorite]** in the next menu and then select the desired station using the Up, Down and Select buttons.

## 6. Listening to podcasts

The WFR-39 is also capable of tuning into many different podcasts from around the world.

To tune into podcasts, turn on the radio and then select the **[Podcast]** item in the radio's main menu. The Podcast menu featuring the following items will now appear on the radio's display:



1. **[My Favorite]:** Select this item to go to the list with your favorite podcasts. These are the presets that you've set on the radio, as well as any station that you have saved as a favorite station.

2. **[Country / Location]:** Select this item to search for podcasts by country. After selecting a country and a genre, you can select the podcast and episode that you want to listen to.

3. **[Genre]:** Select this item to search for podcasts based on a specific genre. After selecting the genre, select a country and select the desired podcast and episode.
4. **[History]:** Select this item to look at the history of the podcasts that you have tuned into.
5. **[Search]:** Select this item to have the radio display a QR code that, when scanned, will take you to the download page of the AirMusic Control app. After downloading and installing this app, you can search for radio station or podcast by name with the app.

### Storing preset / favorite podcasts

The WFR-39 can store up to 99 presets / favorite podcasts.

To store a podcast as a preset / favorite podcast, follow these steps:

1. Turn on the radio.
2. Select **[Podcast]** from the main menu, go to any podcast list and highlight or tune into a podcast.
3. Press and hold the Preset button for 2-3 seconds then release to enter the preset setting menu, where you can use the Up, Down and Select buttons to select and confirm the required preset number.
4. Alternatively, after highlighting a podcast, you can also press the Right button and then in the next menu select the **[Add to My Favorite]** item.
5. Repeat this procedure as needed for the remaining presets.

**Note:** Presets / favorite podcasts that have been added to the preset / favorite list cannot be added again to a different preset / favorite number.

### Recalling presets / favorite podcasts

Presets / favorite podcasts can be recalled in two ways:

- Select **[Podcast]** from the radio's main menu, press the Preset button and then select the desired podcast using the Up, Down and Select buttons.
- Select **[Podcast]** from the radio's main menu, select **[My Favorite]** in the next menu and then select the desired podcast using the Up, Down and Select buttons.

## 7. Spotify Connect

The Spotify Software is subject to third party licenses found here:



<https://www.spotify.com/connect/third-party-licenses>

Use your phone, tablet or computer as a remote control for Spotify. Go to [spotify.com/connect](https://www.spotify.com/connect) to learn how.

## 8. Listening to DAB radio

### Tuning into DAB stations

To tune into DAB stations, first turn on the radio and then select **[DAB / DAB+]** from the radio's main menu. The radio will now automatically scan for DAB stations and a counter will be shown on the display to indicate how many stations have been found.

After the scan had completed, the radio will show a list with all found stations. Use the Up and Down buttons to

highlight a station and then press the Select button to tune into the station. Press the Left or Right button to scan for stations again or press the Home button to go back to the radio's main menu.

**Note:** Before selecting the DAB radio mode and performing a scan, make sure the DAB / FM antenna at the back of the radio has been fully stretched out and positioned upright.

### Storing preset DAB stations

The WFR-39 features 99 memory presets for DAB radio.

To store a DAB station as a preset / favorite DAB station, follow these steps:

1. Turn on the radio.
2. Select **[DAB / DAB+]** from the main menu and tune into the required radio station as previously described.
3. Press and hold the Preset button for 2-3 seconds then release to enter the preset setting menu.
4. Select a preset number using the Up and Down buttons and press the Select button to save the station under the chosen preset number.
5. Repeat this procedure as needed for the remaining presets.

**Note:** Preset / favorite stations that have been added to the preset / favorite list cannot be added again to a different preset / favorite number.

### Recalling preset DAB stations

To recall preset stations in the DAB radio mode, simply turn on the radio, select **[DAB / DAB+]** from the main menu, press the Preset button and then select the desired preset station using the Up, Down and Select button.

## 9. Listening to FM radio

### Tuning into FM stations

To tune into FM stations, first turn on the radio and then select **[FM]** from the radio's main menu. You can now perform an automatic scan to search for FM stations or manually tune into an FM station.

### Performing an automatic scan

Follow these steps to perform an automatic scan of the FM band:

1. Press the Select button.
2. Select **[Yes]** on the screen that appears asking if the radio should perform an Auto scan.
3. The radio will now automatically scan the full waveband for FM radio stations and store the stations it finds as preset stations.

### Manually tuning into FM stations

To manually tune into FM radio stations, follow these steps:

1. Press and hold the Left or Right button to automatically tune into an FM station with a lower or higher frequency respectively. Your radio will stop scanning when it finds a station of sufficient strength. The radio's display will show the frequency that the radio is currently tuned into and the signal strength will be shown next to the radio icon in the upper left corner of the radio's display.

2. To fine-tune to a certain frequency, press the Left or Down button to decrease the frequency or press the Right or Up button to increase the frequency.

3. Repeat steps 1 and 2 to tune into other radio stations.

**Note:** Before selecting the FM radio mode and tuning into stations, make sure the DAB / FM antenna at the back of the radio has been fully extended and positioned upright.

### Storing and recalling preset FM stations

The WFR-39 features 99 memory presets for FM radio.

After selecting the FM radio mode, the procedure for storing and recalling preset stations in the FM radio mode is identical to the procedure in the DAB radio mode. Please refer to the instruction in the previous chapter for details on how to store and recall preset stations.

## 10. Listening to music using the radio's media center features

Aside from Spotify Connect, the WFR-39 also allows you to connect to various other cloud music services and UPnP servers via the **[Media Center]** item in the radio's main menu.

### Podcasts

Select the **[Podcasts]** item to search for regular podcasts through various lists or a search feature and add podcasts to a favorites list. A detailed description of this feature can be found in chapter 6 "Listening to podcasts".

### Audio playback via cloud music services

The WFR-39 has support for various cloud music services. After selecting "Media Center" in the main menu, select "Cloud Music" in the Media Center submenu. A list of available cloud music services will appear on the display:

1. **Amazon Music:** Amazon Music is an online music streaming service that requires a paid subscription to log in and use on this radio. Refer to <https://music.amazon.com/> for more information regarding the use of this service.
2. **Deezer:** Deezer is an online music streaming service that requires you to have a paid subscription, log in and use on this radio. Refer to <https://www.deezer.com> for more information regarding the use of this service.
3. **Napster:** Napster is an online music streaming service that requires you to have a paid subscription to log in and use on this radio. Refer to <https://www.napster.com> for more information regarding the use of this service.
4. **Qobuz:** Qobuz is an online music streaming service that requires you to have a paid subscription to log in and use on this radio. Refer to <https://www.qobuz.com/> for more information regarding the use of this service.
5. **TIDAL:** TIDAL is an online music streaming service that requires you to have a paid subscription to log in and use on this radio. Refer to <https://tidal.com/> for more information regarding the use of this service.

### Audio playback via UPnP server

The WFR-39 also support playback from files hosted on a UPnP server. In most cases, computers will be used as UPnP servers. The most common and most convenient

UPnP server application is Windows Media Player (version 10 or later), as Windows is the most popular operating system for home computers and Windows Media Player is built into the Windows operating system.

### Setting up a UPnP server and playing audio using Windows Media Player

Follow these steps to set up a UPnP server using Windows Media Player (version 10 or later):

1. Turn on your PC and make sure it is connected to the same network as your WFR-39.
2. Make sure the WFR-39 is turned on as well and the **[UPnP]** item is selected in the **[Media Center]** menu.
3. Add the music files, and folders that you want to share with the radio to your Windows Media Player library by clicking **Organize > Manage libraries > Music** on the computer.

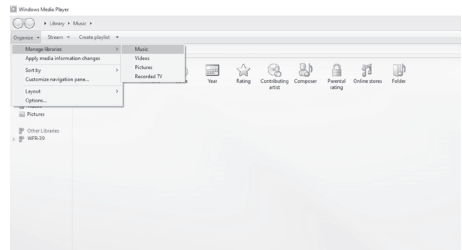

4. Click on the **Add...** button in the window that appears on the computer to add folders and / or files and click on the OK button after adding all your files and folders to your music library.

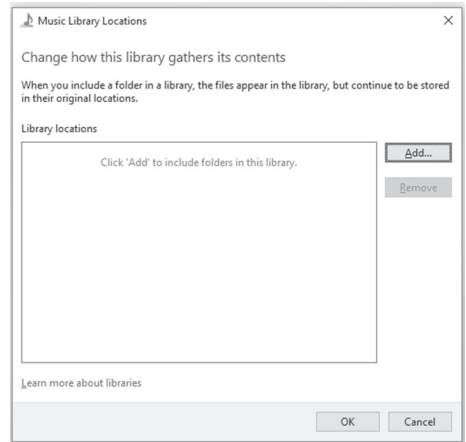

5. After completing setting up your music library, click on **Stream > Turn on media streaming...** on the computer.

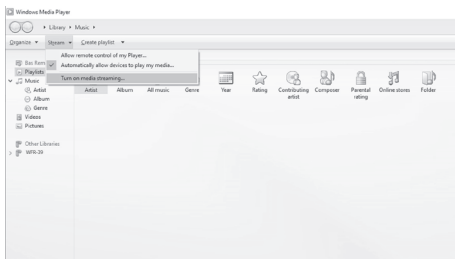

- After turning on media streaming, a new window will appear in which you can configure which devices have access to the media library. Make sure the radio ("WFR-39" in the screenshot below) is allowed access to the media library and click **OK** on the computer.

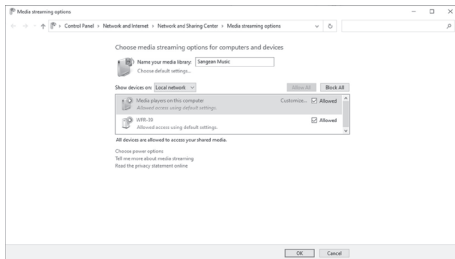

- The radio will now be able to browse through the media library shared on the PC. Simply select the file or playlist that you want to play on the radio to enjoy your PC's music library through your radio's speaker.
- When you first set up sharing with a UPnP server, not all of your files will be available immediately. The UPnP server must look inside each file to identify the artist and album information from 'tags' embedded in them. The server may also need time to access the Internet to obtain additional information such as 'album art', which it can display when you examine your music library on your PC. For a library of many files this can take some time.

If the display shows "empty", please leave the UPnP mode first, wait 3 to 5 minutes for the device to search for files on the UPnP server, and then enter the UPnP mode again.

- After playback has started, the display will show the "Now Playing" screen with cover art (if available), the artist's name, the title name, the album name, the composer's name and the playback progress. Repeatedly press on the Right button to zoom in on the cover art or view it in full screen.
- Playback can be controlled by pressing the Select button to play / pause playback, pressing the Down button or pressing and holding the Right button to go to the next track and pressing the Up button or pressing and holding the Left button to go to the previous track.

### Casting music to the radio

Windows Media Player also allows users to cast music to the radio. This can be convenient when you are working on your PC and want to play songs through the radio's speaker without having to actually control the radio. Follow these steps to cast songs to the WFR-39:

- Make sure all steps from the previous section have been followed, that the radio is still in the UPnP mode and that both the PC and the radio are still connected to the same network.
- Go to your music library in Windows Media Player and right click on a song, album, genre, or playlist and then select Cast to > WFR-39.
- The song (s) will now be cast to the radio and automatically played through the radio's speaker.

**Note:** Some Windows security software can prevent correct operation of the 'Play to' / 'Cast to Device' function. Such software may have updates or configuration options which will permit 'Play to' / 'Cast to Device' to operate correctly - please consult your anti-virus software supplier.

### Using UPnP server on Mac or Linux

Although this manual only describes how to set up a UPnP server on Windows using Windows Media Player, there are similar applications available for macOS and Linux.

A list of UPnP server applications for your platform can be found at

[https://en.wikipedia.org/wiki/List\\_of\\_UPnP\\_AV\\_media\\_servers\\_and\\_clients](https://en.wikipedia.org/wiki/List_of_UPnP_AV_media_servers_and_clients).

Please refer to the documentation that is provided with these applications for more information on how to set up the server.

### Supported formats

- MP3 (bit rate up to 320kbts/s, sampling rate up to 48kHz)
- AAC / AAC+ (bit rate up to 320kbts/s, sampling rate up to 48kHz)
- WMA (bit rate up to 320kbts/s, sampling rate up to 48kHz)
- WAV / FLAC (sampling rate up to 48kHz)

### 11. Listening to music using the headphone jack

The WFR-39 is equipped with a Headphones socket at the back of the radio, which can be used to connect a pair of headphones with a 3.5mm plug. To connect the headphones, simply plug the 3.5mm jack into the socket. The radio will then automatically detect that a pair of headphones have been connected and it will disable its internal speaker.

We recommend turning the volume down before connecting the headphones and raising it slowly to a suitable level after connecting the headphones to avoid loud sounds and damaging your hearing.

**Note:** Excessive sound pressure from earphones and headphones can cause hearing loss. To prevent possible hearing damage, do not listen at high volume levels for long periods of time.

GB

## 12. Troubleshooting

Observation	Possible cause / solution
The radio is not functioning properly.	<ul style="list-style-type: none"><li>• Try performing a factory reset.</li><li>• Turn off the radio, disconnect it from the power source, wait 1 minute and then reconnect the radio to the power source and turn it on.</li></ul>
No Internet Connection	<ul style="list-style-type: none"><li>• Ensure that Wi-Fi has been enabled in settings and that the correct password has been entered for the Wi-Fi network.</li><li>• Try performing a factory reset and then try reconnecting to the Wi-Fi network.</li><li>• Turn off the radio, disconnect it from the power source, wait 1 minute and then reconnect the radio to the power source and turn it on.</li></ul>

## 13. Specifications

<b>Built-in Lithium-ion Battery</b>	3.65V / 2.6A
<b>USB Power Cable</b>	USB Type-A to Type-C (included)
<b>Power Adapter</b>	DC 5V / 2.4A (Not included)
<b>Battery life</b>	approx. 7 hours of listening at normal volume level
<b>Charging time</b>	approx. 5.5 hours in standby mode approx. 13 hours in power on mode
<b>Frequency range</b>	DAB band: 174.928-239.2 MHz FM band: 87.5-108 MHz
<b>Wi-Fi</b>	
The frequency and maximum transmitted power	2412MHz ~ 2472MHz for 11b / g / n (HT20) / 11n (HT40): 17.291dBm
802.11b / g / n (WLAN) Encryption	WEP, WPA, WPA 2 (PSK), WPS
<b>Electronic features</b>	
Loudspeaker	2.25" 8ohm
Output Power	1W
Headphone socket	3.5mm diameter Stereo Output
<b>Operating temperature range</b>	0°C to +40°C

※ The barcode label on the product is defined as below:

	<p>aH 18 12 00001</p> <p>↑ ↑ ↑ ↑ ↑</p> <p>Serial number Production month Production year Product code</p>
---	---



Sangean reserves the right to amend the specifications without notice.



RECYCLING This product bears the selective sorting symbol for Waste electrical and electronic equipment (WEEE). This means that this product must be handled pursuant to European directive 2012/19/EU in order to be recycled or dismantled to minimize its impact on the environment.