

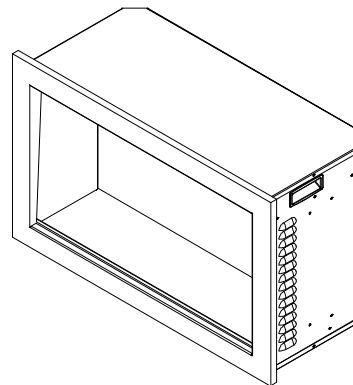

INSTALLATION AND OPERATION INSTRUCTIONS FOR

TRD-26
TRD-30
TRD-33
TRD-38
TRD-44
TRD-48



SAFETY INFORMATION

 **WARNING**

For your safety, always comply with all warnings and safety instructions contained in this manual to prevent personal injury or property damage.

Do not store or use gasoline or other flammable vapors and liquids in the vicinity of this appliance.

INSTALLER: LEAVE OWNER'S MANUAL WITH THE APPLIANCE.

CONSUMER: RETAIN OWNER'S MANUAL FOR FUTURE REFERENCE.



WARNING: This product can expose you to chemicals including Lead in the wiring, which is [are] known to the State of California to cause birth defects or other reproductive harm. For more information visit: www.p65warnings.ca.gov

Please read and carefully follow all of the instruction found in this manual. Please pay special attention to the safety instructions provided in this manual. The instructions included here will assure that you have many years of dependable and enjoyable service from your Amantii product.

Table of Contents

IMPORTANT INSTRUCTIONS	3
PLUG INSTALLATION.....	6
UNPACKING AND TESTING APPLIANCE	7
LOCATING THE FIREPLACE.....	7
TRD-26.....	8
TRD-30.....	9
TRD-33.....	10
TRD-38.....	11
TRD-44.....	12
TRD-48.....	13
INSTALLATION BUILT-IN.....	14
MEDIA OPTIONS	18
OPERATION	19
MANUAL OPERATION.....	19
REMOTE CONTROL OPERATION	20
CARE AND MAINTENANCE.....	23
REPLACEMENT PARTS.....	24
EXPLODED VIEW.....	26
TROUBLE SHOOTING.....	27
SERVICE HISTORY	28
WARRANTY	29

IMPORTANT INSTRUCTIONS

Please read the following instructions carefully before using the appliance.

Caution - Fire, electric shock, physical injury and material damage hazards:

To use the appliance, always follow the instructions for assembly, use and maintenance as well as usage cautions:

1. Carefully read and retain these instructions.
2. Before connecting the appliance, be sure that the mains voltage available matches that specified on the rating plate.
3. Do not use the appliance for other than its intended use. For domestic indoor use only.
4. There may be trace of odour during the first few minutes of initial use. This is normal and will quickly disappear.
5. The heater is hot when in use. To avoid burns, do not let bare skin touch any hot surface.
6. Keep combustible material such as furniture, cushions, bedding, paper, clothes, curtains etc. at least 1m away from the heater.
7. Do not use the heater in areas where flammable liquids are stored or where flammable fumes may be present.
8. Do not cover or obstruct any of the heat outlet grilles or the air intake openings of the heater.
9. Do not use the heater in the rooms with explosive gas or while using inflammable solvents, varnish or glue.
10. Keep the heater clean. Do not allow any objects to enter any ventilation or exhaust opening as this may cause electric shock, or fire or damage to the heater.
11. Always unplug or disconnect the appliance from the mains power supply when not in use or when moving or cleaning it. Do not pull the cord to unplug the heater.
12. Do not immerse the cord, plug or any part of the appliance in water or any other liquid.
13. Do not attempt to repair, disassemble or modify the appliance. There are no user-serviceable parts inside.
14. The heater must not be located immediately below a socket-outlet.
15. Do not use this heater in the immediate surroundings of a bath, a shower or a swimming pool.
16. CAUTION: In order to avoid a hazard due to inadvertent resetting of the thermal cutout, this appliance must not be supplied through an external switching device, such as a timer, or connected to a circuit that is regularly switched on and off by the utility.
17. Do not use this heater with a programmer, timer, separate remote-control system or any other device that switches the heater on automatically, since a fire risk exists if the heater is covered or positioned incorrectly.
18.  **WARNING:** In order to avoid overheating, do not cover the heater.
19. **WARNING!** – DO NOT COVER THIS APPLIANCE WITH ITEMS SUCH AS CLOTHING, BLANKETS OR PLACE NEXT TO CURTAINS OR NET/BLINDS.
20. If the supply cord is damaged, it must be replaced by the manufacturer, its service agent or similarly qualified persons in order to avoid a hazard.
21. Do not use this heater in small rooms when they are occupied by persons not capable of leaving

the room on their own, unless constant supervision is provided.

22. If the glass is damaged, do not use the heater in order to avoid a hazard.
23. Children of less than 3 years should be kept away from unless continuously supervised.
24. Children aged from 3 years and less than 8 years shall only switch on/off the appliance provided that it has been placed or installed in its intended normal operating position and they have been given supervision or instruction concerning use of the appliance in a safe way and understand the hazards involved, Children aged from 3 years and less than 8 years shall not plug in, regulate and clean the appliance or perform user maintenance.
25. **CAUTION** Some parts of this product can become very hot and cause burns. Particular attention has to be given where children and vulnerable people are present.
26. This appliance can be used by children aged from 8 years and above and persons with reduced physical, sensory or mental capabilities or lack of experience and knowledge if they have been given supervision or instruction concerning use of the appliance in a safe way and understand the hazards involved. Children shall not play with the appliance. Cleaning and user maintenance shall not be made by children without supervision.
27. The heater may emit a slight, harmless odour and smoke when first used. This odour and smoke is normal and it is caused by the initial heating of internal heater parts and will not occur again.
28. **DO NOT** plug into an extension lead/cable or plug adaptor.
29. **DO NOT** cut off the plug and hardwire directly into the mains or via a fused fixed spur.
30. For details about installing the fireplace, please refer to "Installation" section.

Cautions

Do's	<ul style="list-style-type: none"> Always install the heater in accordance with this guide. If in doubt obtain expert advice.
	<ul style="list-style-type: none"> Always make sure the electrical socket is accessible and located adjacent to, but not above the heater.
	<ul style="list-style-type: none"> Always disconnect the heater from the electrical supply before moving it, or carrying out cleaning, maintenance.
	<ul style="list-style-type: none"> Always make sure the heater is firmly secured to prevent it from being tipped over.
	<ul style="list-style-type: none"> Always use a fireguard when young children and infirm persons can come into contact with the heater.
Don'ts	<ul style="list-style-type: none"> Never leave children unsupervised in a room where the heater is ON and unguarded.
	<ul style="list-style-type: none"> Never obstruct or cover the fan outlet or force items into heater openings.
	<ul style="list-style-type: none"> Never install or use the heater anywhere where water is in use, i.e. Bathroom, Kitchens, Shower Rooms, and Swimming Pool etc.
	<ul style="list-style-type: none"> Never use aerosols or steam cleaners on or around the heater.
	<ul style="list-style-type: none"> Never route the mains supply cable under carpet etc.
	<ul style="list-style-type: none"> Never install the heater close to curtains or combustible materials.
	<ul style="list-style-type: none"> Never use the heater to dry clothes etc.
	<ul style="list-style-type: none"> Never sit or stand on the heater.
<ul style="list-style-type: none"> Never use with a timer or any other device that switches the fire on automatically. 	

PLUG INSTALLATION

Your power cord will come separate from the unit, please locate it when unpacking your fireplace. The plug contained inside the box is predetermined at the factory and according to orders placed by authorized dealers.

Available are UK, European, Swiss & Australian plugs. Should you require any of these options please contact your dealer for purchase. You will be required to give them the correct part number as listed below.



UK plug
10103060E

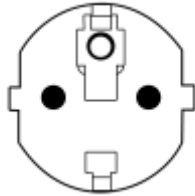

European plug
10103030E



Swiss plug
10103109E

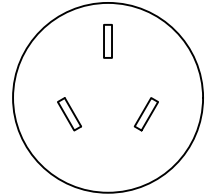

Australian plug
10103087F

Please following the instructions to correctly install the plug into your fireplace.

1. Included in the box will be a power cord similar to the one pictured below. See Picture 1.



Picture 1



Picture 2

2. Hold the male plug and insert it into the female receptacle. The receptacle is locate on the left side if the fireplace.



3. Please make sure the plugs are firmly connected. See Picture 2 above.

UNPACKING AND TESTING APPLIANCE

Carefully remove the appliance from the box.

Prior to installing the appliance, test to make sure the appliance operates properly by plugging the power supply cord into a 240 Volt grounded outlet.

Test all aspects of its operation (manual switches, remote and heater) to make sure all components are operating correctly.

As with most electronic devices, your new electric fireplace has been designed to operate at temperatures between 5 °C (41°F) and 35 °C (95°F). During the cold winter months, allow the fireplace to reach room temperature before turning it on.

NOTE: There may be trace of odor during the first few minutes of initial use. This is harmless, normal and will never occur again.

LOCATING THE FIREPLACE

Plan where to locate and frame the fireplace. This will save time and money later when you install the fireplace. Before installation consider the following:

1. Where the fireplace is located must allow for wall and ceiling clearances
2. Consider a location where the fireplace screen will not be exposed to direct sunlight from windows or doors.
3. A 15 ampere, 240 Volt, 50-60 Hz branch circuit with proper ground must be available at the location. Preferably a dedicated branch circuit should be provided to avoid circuit breakers to trip or fuses to blow.

TRD - 26

Description	ELECTRIC FIREPLACE
Voltage	220-240V AC 50-60Hz
Watts	1500W Max
NO HEATER	25W
MOTOR HEATER	19W
Appliance Width	27 3/8" or 69.4 cm
Appliance Height	16 3/4" or 42.5 cm
Appliance Depth	12" or 30.6 cm
Gross Weight	50.7 lbs or 22 kgs
Plug Location	Left side
Cord Length	70 7/8" or 180 cm
Rough Wall Opening Size	26 1/4" x 17 1/4" 66.74 cm x 43.77 cm
BTU	5118

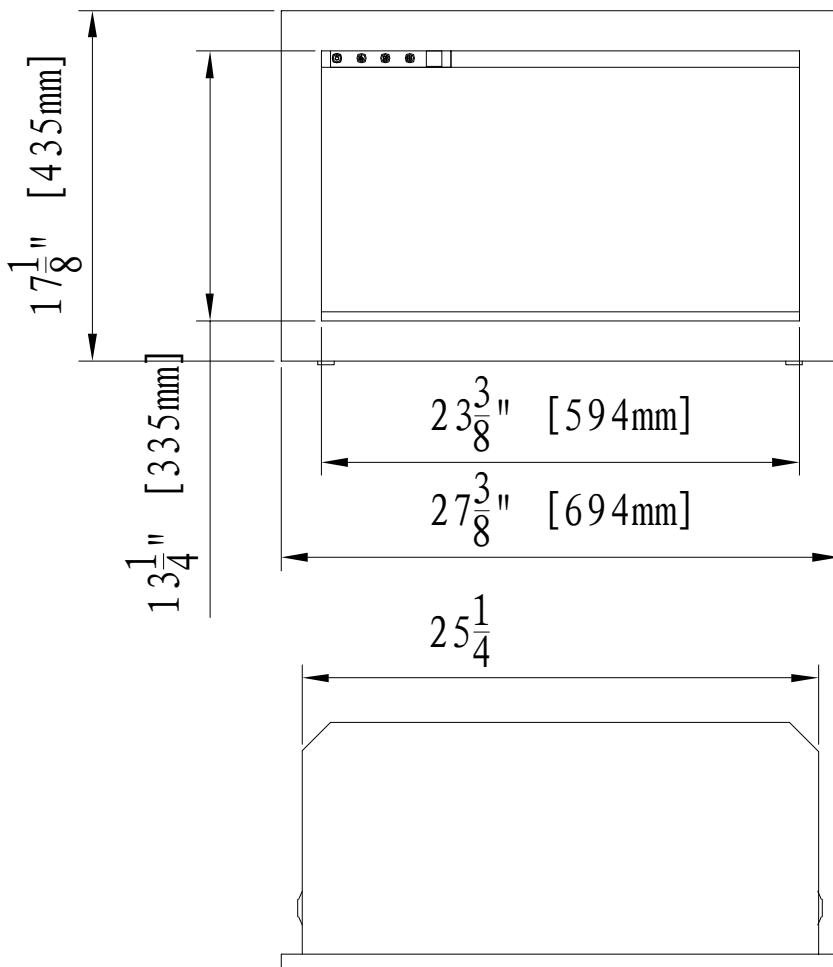

TRD - 30

Description	ELECTRIC FIREPLACE
Voltage	220-240V AC 50-60Hz
Watts	1500W Max
NO HEATER	25W
MOTOR HEATER	19W
Appliance Width	31 1/2" or 79.9 cm
Appliance Height	19 1/8" or 48.5 cm
Appliance Depth	12" or 30.6 cm
Gross Weight	50.7 lbs or 22 kgs
Plug Location	Left side
Cord Length	70 7/8" or 180 cm
Rough Wall Opening Size	30 3/8" x 19 5/8" 77.24 cm x 49.77 cm
BTU	5118

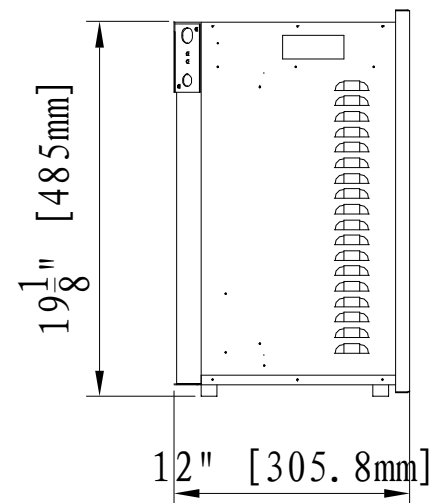
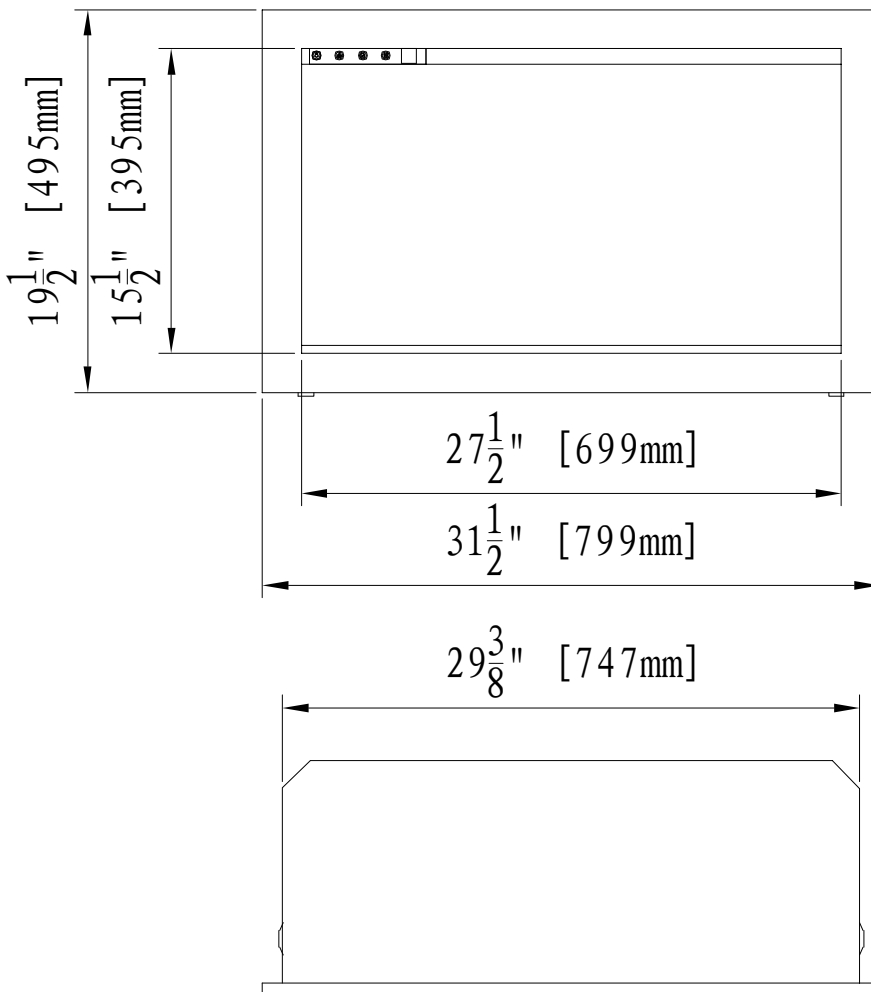

TRD - 33

Description	ELECTRIC FIREPLACE
Voltage	220-240V AC 50-60Hz
Watts	1500W Max
NO HEATER	25W
MOTOR HEATER	19W
Appliance Width	33 7/8" or 86 cm
Appliance Height	21 5/8" or 55 cm
Appliance Depth	12" or 30.6 cm
Gross Weight	50.7 lbs or 22 kgs
Plug Location	Left side
Cord Length	70 7/8" or 180 cm
Rough Wall Opening Size	32 3/4" x 22 1/8" 83.24 cm x 56.27 cm
BTU	5118

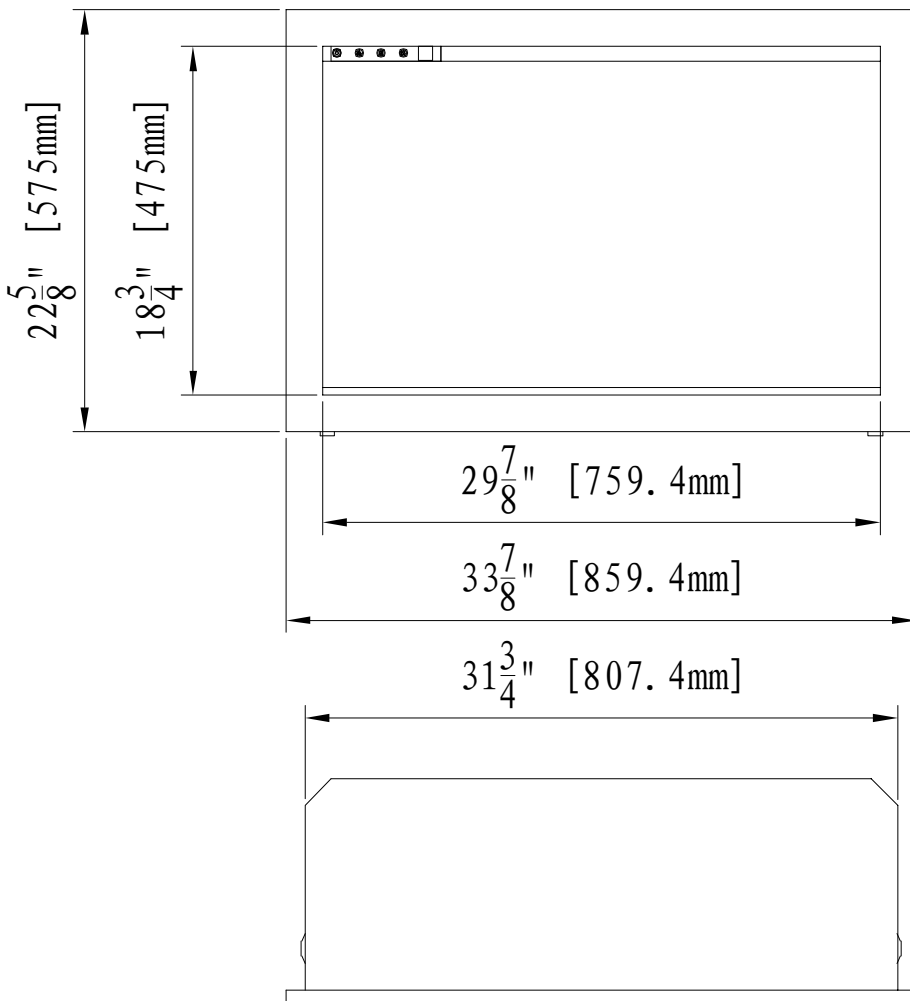

TRD - 38

Description	ELECTRIC FIREPLACE
Voltage	220-240V AC 50-60Hz
Watts	1500W Max
NO HEATER	25W
MOTOR HEATER	19W
Appliance Width	39 1/4" or 99.6 cm
Appliance Height	27 1/4" or 69.1 cm
Appliance Depth	13" or 33.1 cm
Gross Weight	50.7 lbs or 22 kgs
Plug Location	Left side
Cord Length	70 7/8" or 180 cm
Rough Wall Opening Size	38 1/8" x 27 3/4" 96.94 cm x 70.37 cm
BTU	5118

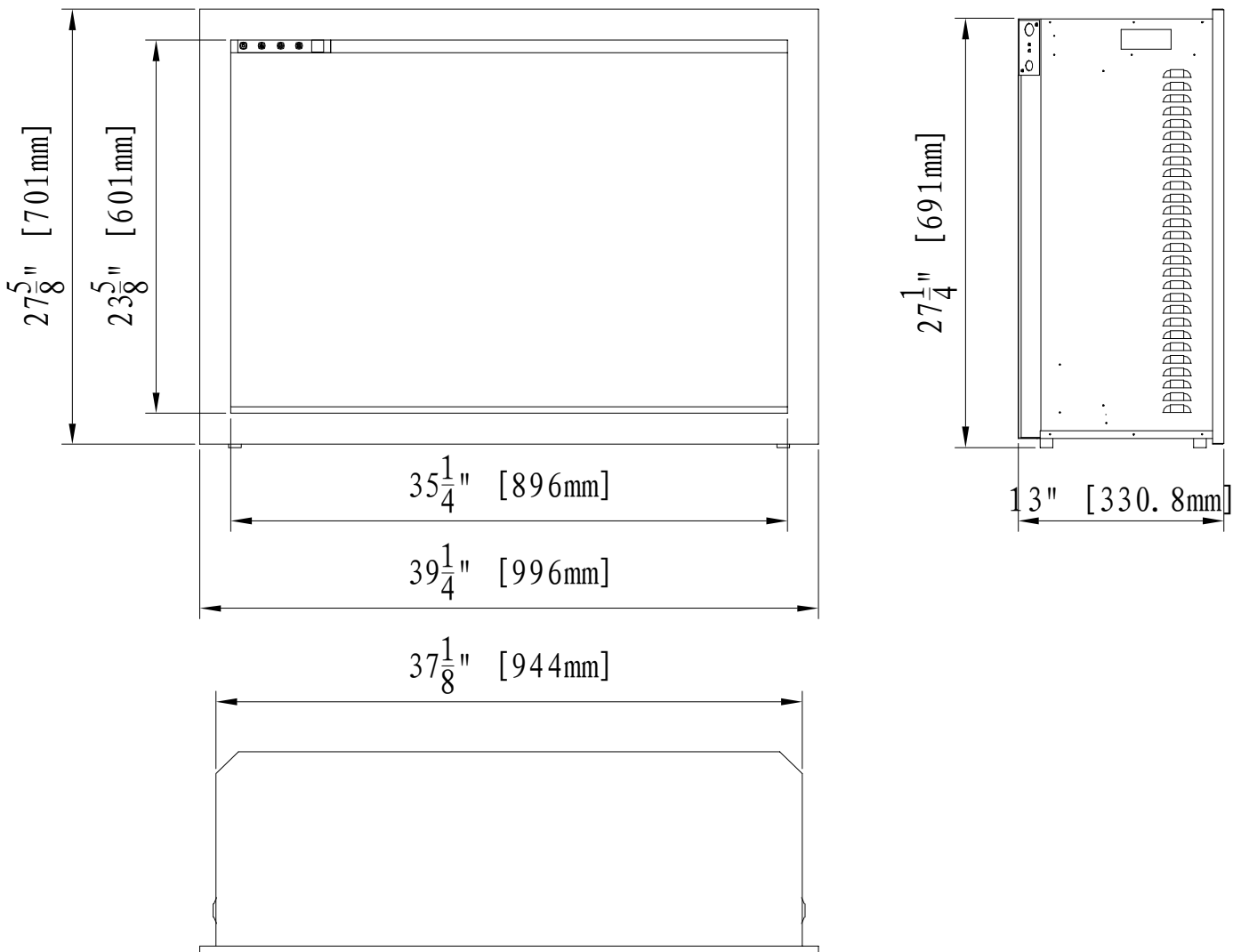

TRD - 44

Description	ELECTRIC FIREPLACE
Voltage	220-240V AC 50-60Hz
Watts	1500W Max
NO HEATER	25W
MOTOR HEATER	19W
Appliance Width	45 1/4" or 115 cm
Appliance Height	31 5/8" or 80.3 cm
Appliance Depth	14 3/8" or 36.58 cm
Gross Weight	50.7 lbs or 22 kgs
Plug Location	Left side
Cord Length	70 7/8" or 180 cm
Rough Wall Opening Size	44 1/4" x 32 1/8" 112.34 cm x 81.57 cm
BTU	5118

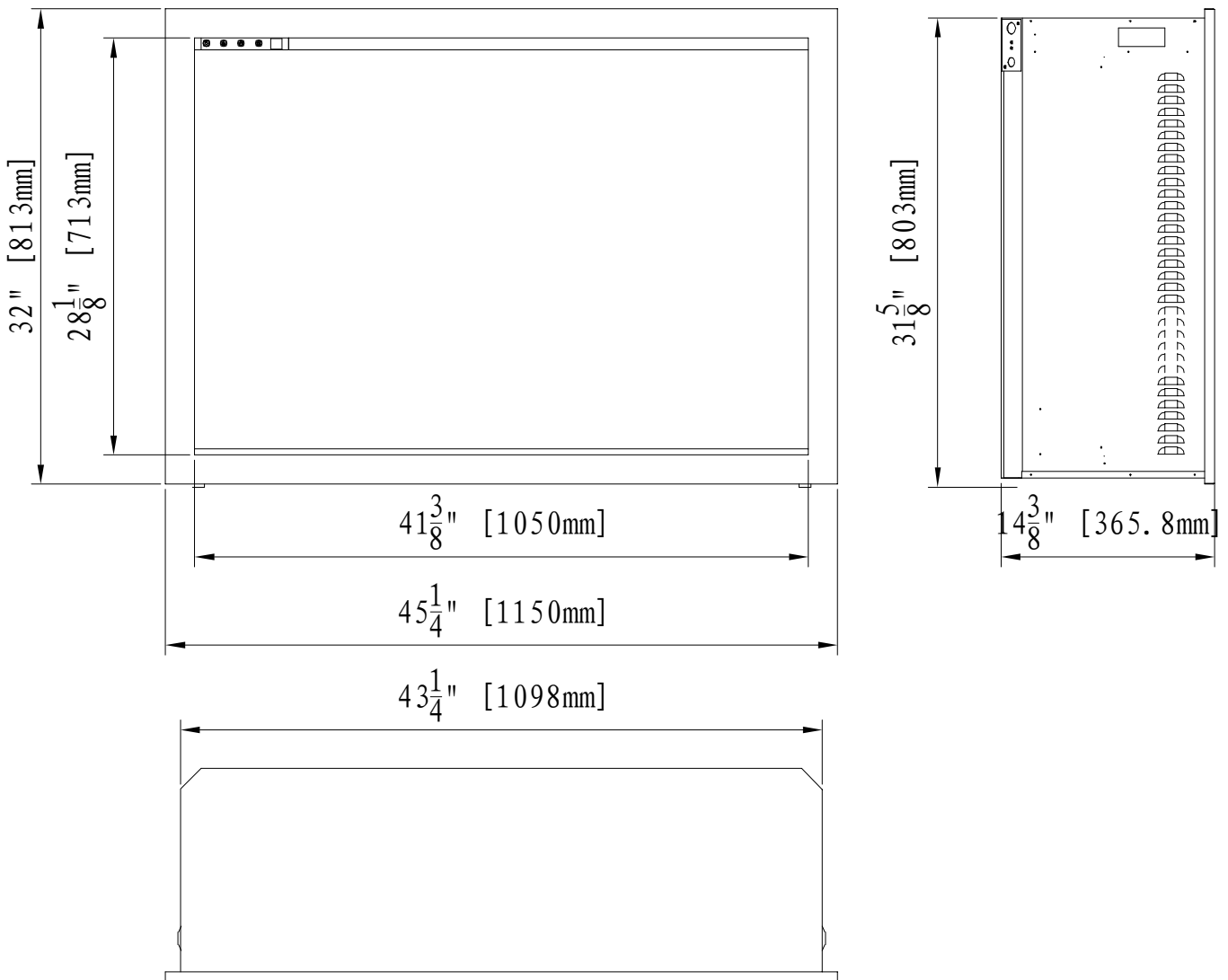

TRD - 48

Description	ELECTRIC FIREPLACE
Voltage	220-240V AC 50-60Hz
Watts	1500W Max
NO HEATER	25W
MOTOR HEATER	19W
Appliance Width	49 1/4" or 115.2 cm
Appliance Height	41 5/8" or 105.7 cm
Appliance Depth	14 3/8" or 36.6 cm
Gross Weight	50.7 lbs or 22 kgs
Plug Location	Left side
Cord Length	70 7/8" or 180 cm
Rough Wall Opening Size	48 1/4" x 42 1/8" 122.54 cm x 106.97 cm
BTU	5118

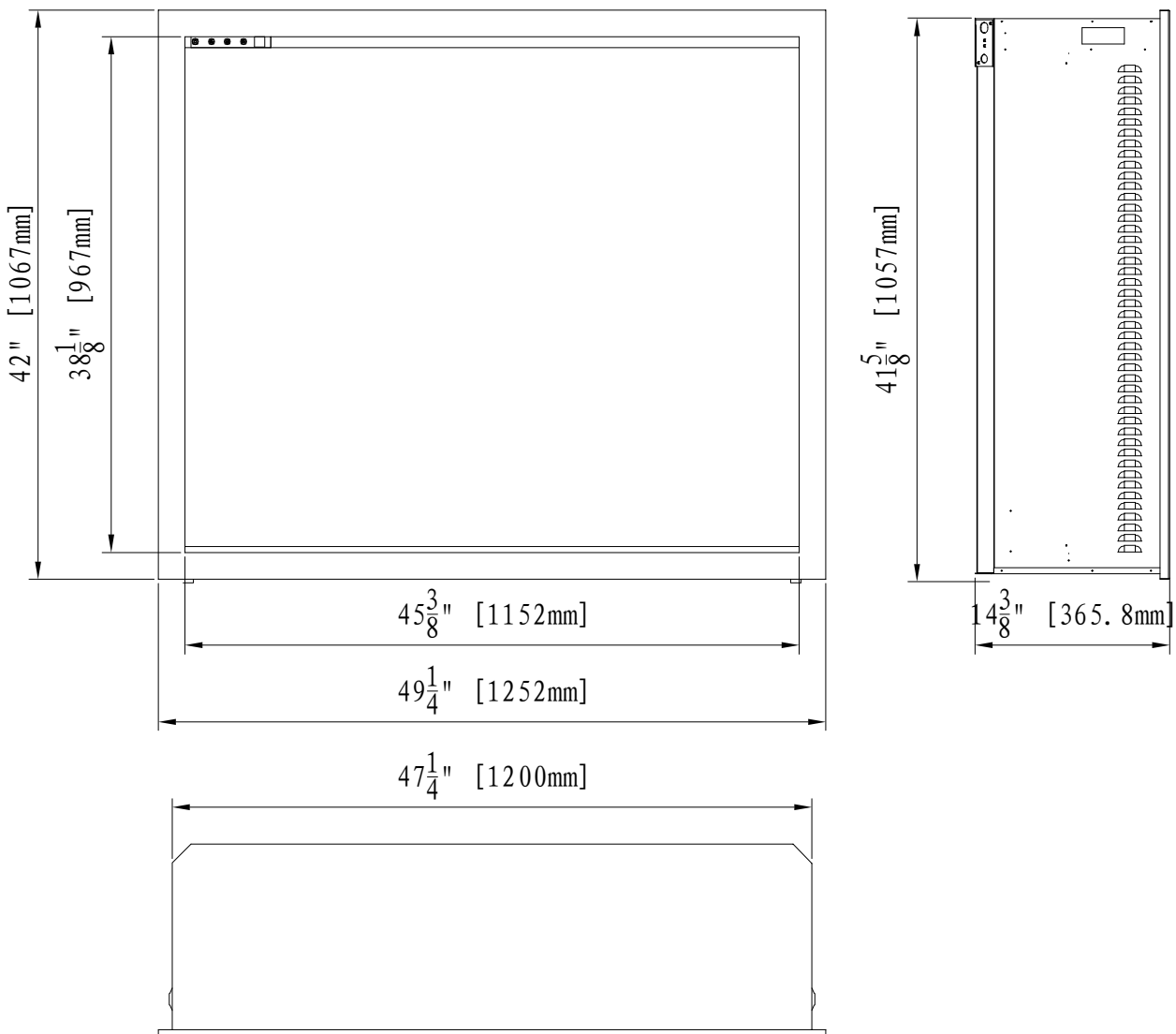

INSTALLATION- BUILT-IN

NOTE: Due to the many different materials used to build walls, it is highly recommended that you consult your local builder before you install this appliance on a wall.

Preparation

1. Select a location that is not prone to moisture and is located at least 0.91m or 3 feet away from combustible materials such as curtains, drapes, furniture, bedding, paper, etc.
2. Mark the desired location on the floor and store the appliance in a safe, dry and dust free place.
3. Prepare a wall with a framed opening to accommodate the size of your unit. Leave at least 1/4" (6mm) around the edge of the appliance. Any new wiring must be done in compliance with local and national codes and other applicable regulations.

Prior to installing, test the appliance to make sure the appliance is fully operational by plugging the power supply cord into a 240 Volt grounded outlet.

The rough wall opening size of the fireplace:

	W(“)	D(“)	H(“)
TRD-26	26 1/4	13	17 1/4
TRD-30	30 3/8	13	19 5/8
TRD-33	32 3/4	13	22 1/8
TRD-38	38 1/8	14	27 3/4
TRD-44	44 1/4	15 3/8	32 1/8
TRD-48	48 1/4	15 3/8	42 1/8

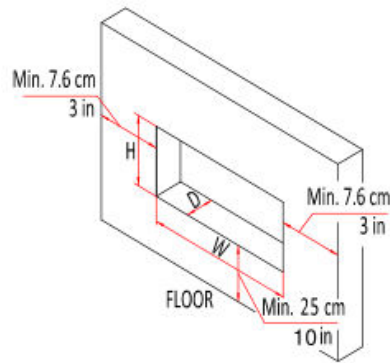

INSTALLATION

1. Unscrew 4 screws and take off the trim. (NOTE: Keep hold of the front glass as it may fall down automatically when the trim is removed.)

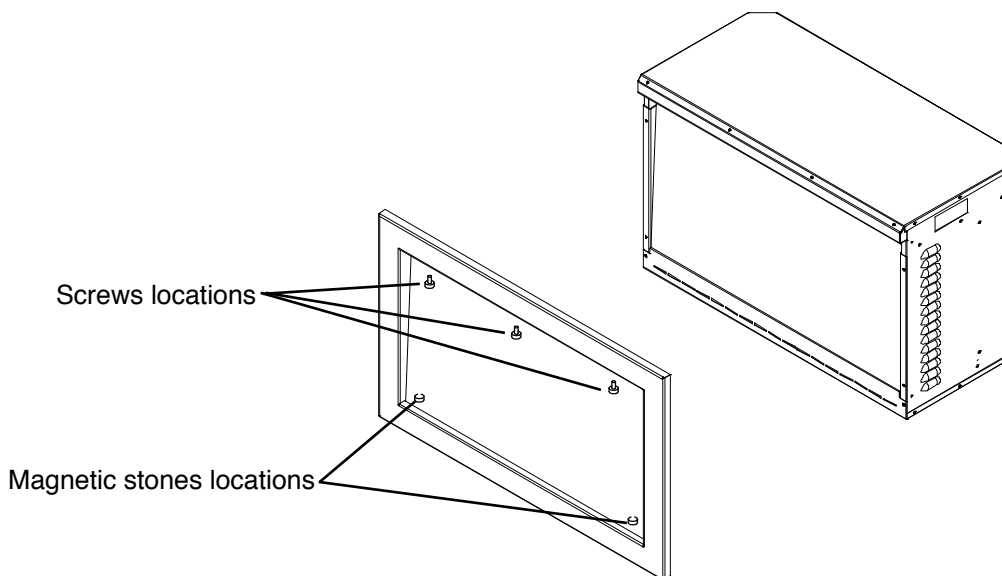

2. When the trim is removed, take off the front glass panel.

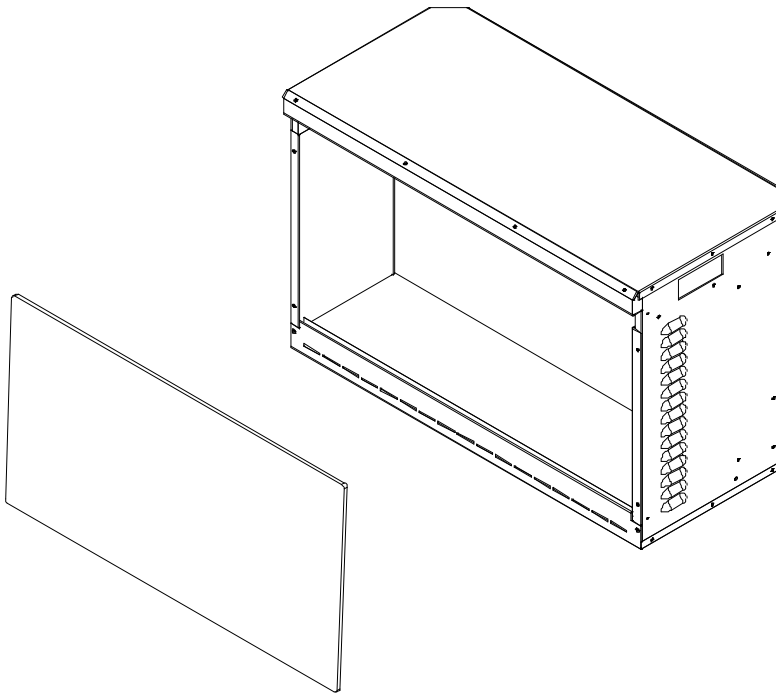

3. Unscrew the screws located on each side and take off the inner side steel panels.

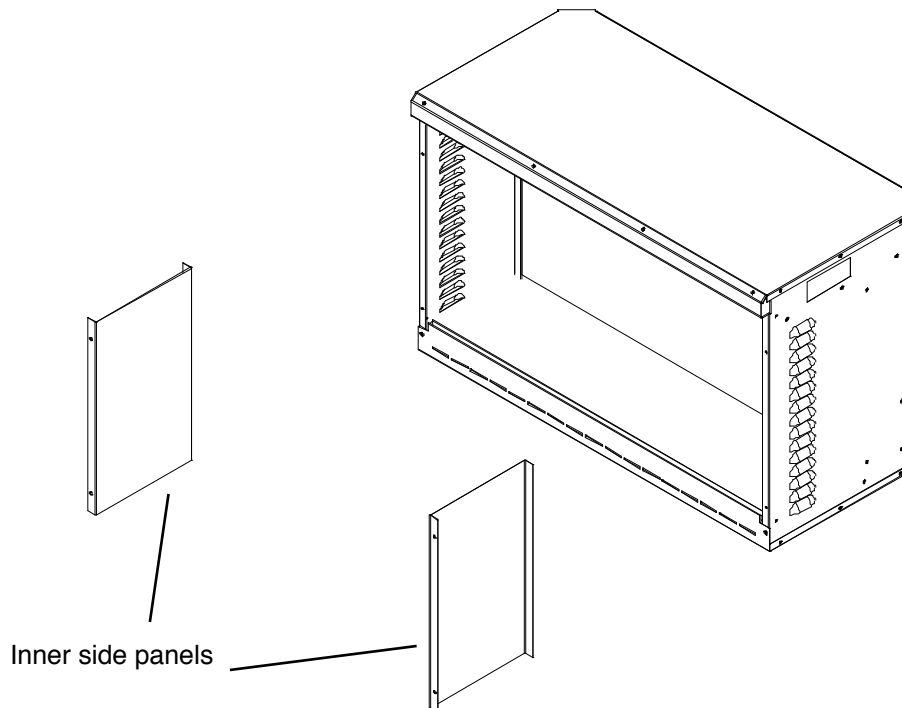

4. Put the trim back onto the appliance and fasten with screws.(NOTE: This step is to make sure that the fireplace fits the wall opening well and there is no gap between the trim and the wall after installation)

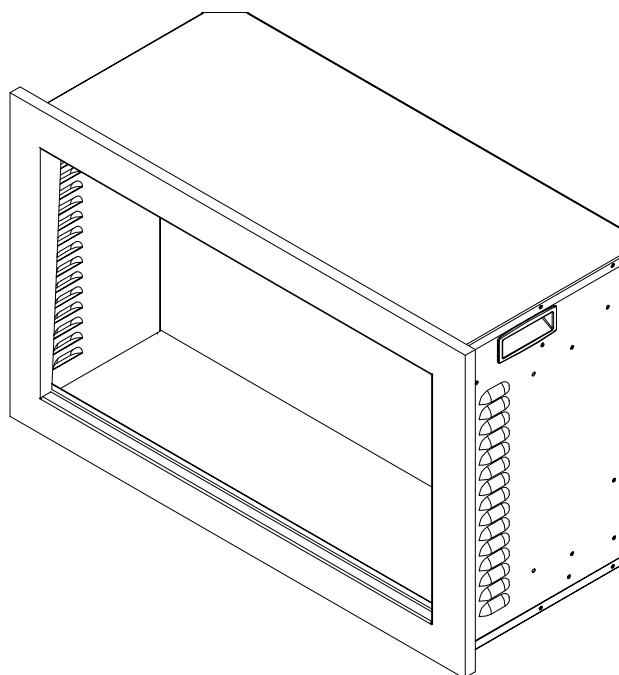

5. Put the fireplace into the wall opening and fix it to the wall by screwing 2 screws each side.

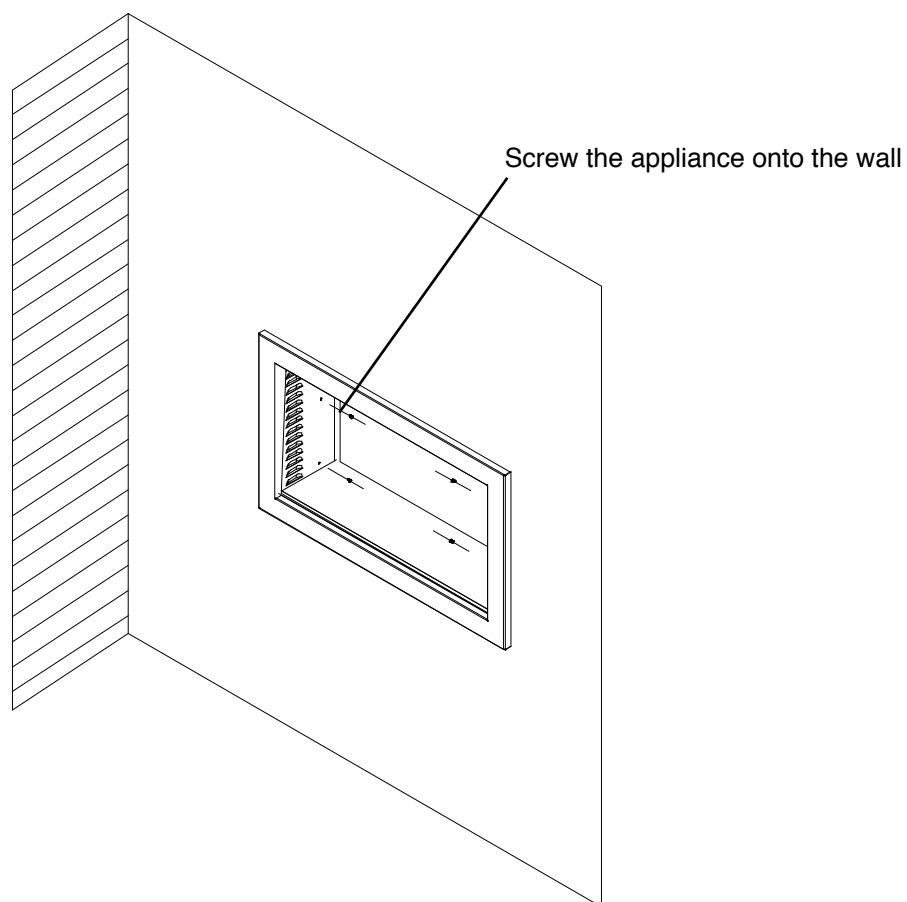

6. Remove the trim following STEP 1. Screw back the inner side steel panels.

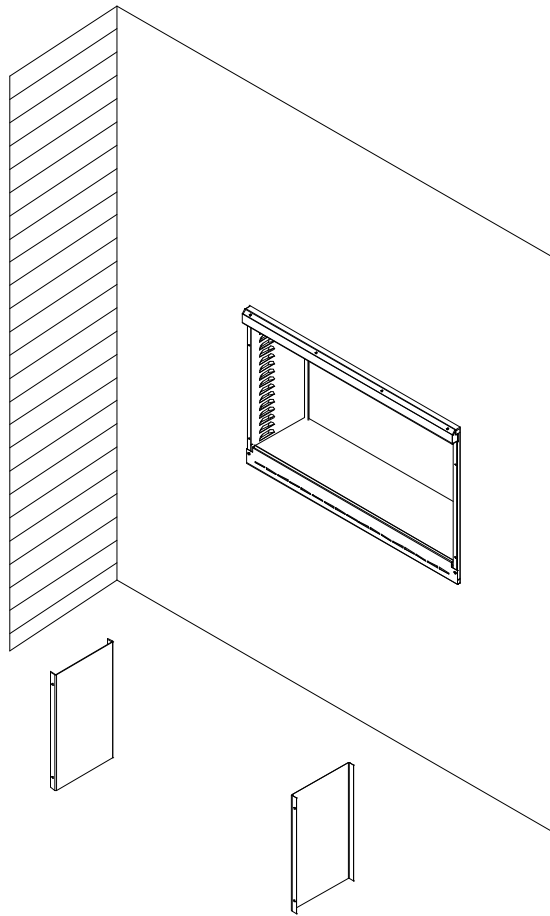

7. Put back the front glass panel and screw back the trim after you finish the media decoration.

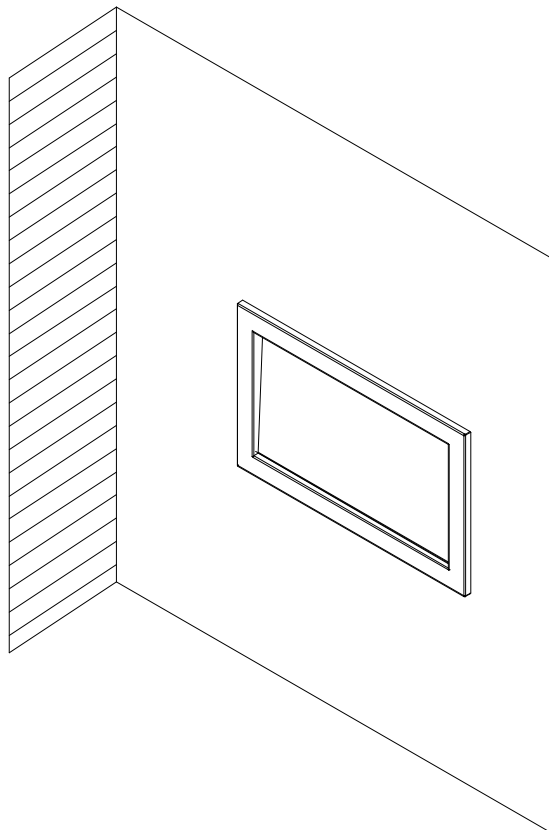

MEDIA OPTIONS

Your fireplace ships with a 10 piece Birch Log Set, two (2) bags of Smoke Glass, one (1) bag of Black Vermiculite and one (1) bag of White Vermiculite.

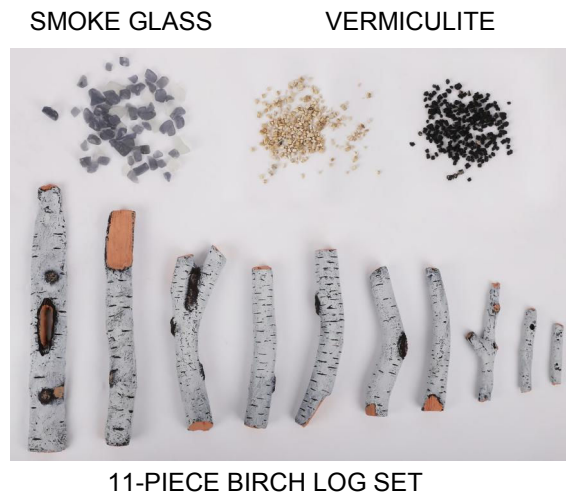

MEDIA INSTALLATION

Unscrew 4 screws and take off the trim. (NOTE: Keep hold of the front glass as it may fall down automatically when the trim is removed.)

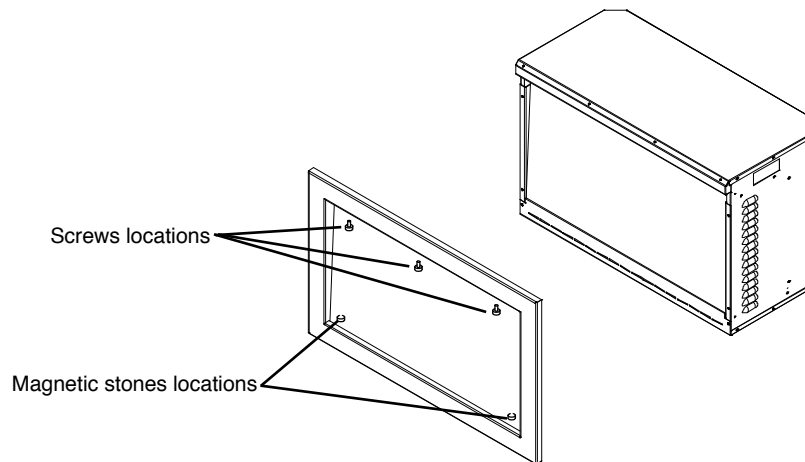

INSTALLING THE DECORATIVE MEDIA

Pour the fire glass media into the tray. Feel free to use any combination of the fire glass media that you find most appealing. Put back the trim and front glass after you finish installing the fire glass.



OPERATION

The fireplace can be operated either by the switches located on the left bottom of the fireplace unit or by supplied remote control.

Plug the fireplace into a 15 Amp wall socket.

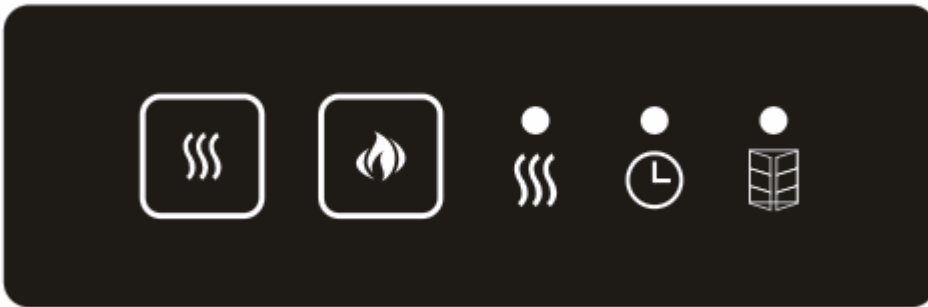
MANUAL OPERATION



1、 Press key . Press for the first time , heater work at 1500W, indicator  lights red.

Press for the second time, heater work at 750W , indicator  lights blue. Press for the







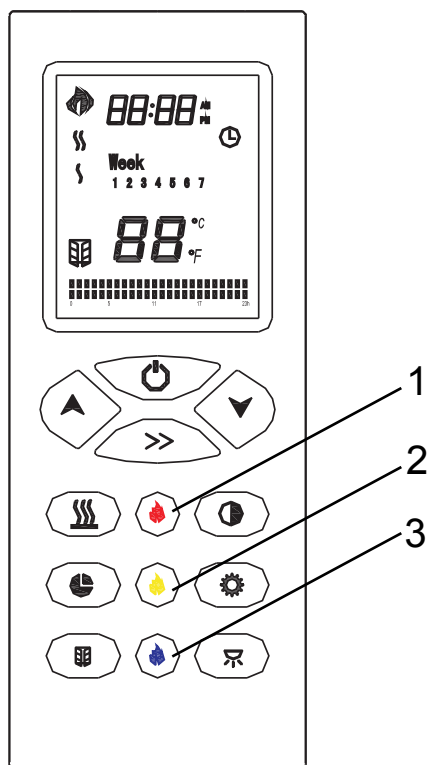

third time, the heating element turns off, indicator  extinguishes.







Note: after the heating elements are turned on manually, the heating elements work but are not controlled by the temperature sensor.

2、 Press key . Press for the first time and the charcoal and flame is in the highest brightness. Press for the second time ,the charcoal and flame is in medium brightness. Press for the third time ,the charcoal and flame is in low brightness. Press for the fourth time , the charcoal and flame goes out. Then it circulates in turn.



REMOTE CONTROL OPERATION













- 1、 Press the remote control's key , its screen turns on, the flame ignites and the flame icon appears on the LCD screen of the remote control. Week, time (24h system), and temperature setting are displayed normally. Press it again, the screen of the remote control will turn off;
- 2、 Key , flame and charcoal control switch. In case of ON, press once, the flame and the charcoal bed go out, the LCD screen does not display . Press it again and the flame and the charcoal bed turn on, the LCD screen displays . The buzzer beeps once when the key is pressed;
- 3、 Press  (1) to adjust the red flame. The buzzer beeps once when the key is pressed;
- 4、 Press  (2) to adjust the yellow flame. The buzzer beeps once when the key is pressed;
- 5、 Press  (3) to adjust the blue flame. The buzzer beeps once when the key is pressed;
- 6、 Press  to turn on, turn off and adjust top light colors. The buzzer beeps once when the key is pressed;



7、 Press the heating key“” . Press for the first time ,the heating elements work at 1500W, the LCD screen displays  , the indicator  on the machine lights red. Press a second time , the heating elements work at 750W, the LCD screen displays  , the indicator  on the machine lights blue. Press a third time and the heating elements turn off, the LCD screen does not display the function icon, the indicator  on the machine goes off. The buzzer beeps once when the key is pressed;

Note: in case the heating elements are turned on by remote control, whether the heating elements work or not depends on the temperature setting and ambient temperature. They work only when the temperature setting is above the ambient temperature.





8、 Press key“ ”“  ” to adjust the temperature setting between 7 and 30 °C. The buzzer beeps when the key is pressed;

9、 Press shift key“  ”. Press once, the corresponding figure flashes. Press “” “” now to set current time and week. The buzzer does not beep when the key is pressed;

10、 Press timing parameter setting key“” . Press for the first time and the LCD screen displays  to indicate Monday. Now the temperature setting flashes, press “”  to set the timing temperature for Monday, press key “  ” to confirm and then press “”  the time setting for timing.. The displayed time parameter is “00-23.” Press “  ”

to set the current operating state of timing function;  indicates that the timing is on currently and the control temperature is the temperature setting,  indicates that the timing is on currently and the control temperature is the temperature setting minus 3 °C, No display indicates timing is off current and the heating elements do not work. Corresponding point flashes when setting. Press for the second time, it displays  , set the parameters





for Tuesday. Press for the 7th time and it displays . Press for the 8th time and it exits and recovers to the current week day;



11、 Press“  .” Press for the first time and the timing function turns on, the LCD screen displays  , the machine’s indicator  lights green. Press again to turn off, icon  on the LCD screen  goes off. After the timing function is turned on, it works according



the parameter settings. The LCD screen lights up according to corresponding parameter settings;

Note: when the time, week and timing parameters are changed, you need to switch on-off the timing key to transfer the timing parameters to the machine. After the machine has received them correctly, the buzzer will beep once.

12、 Press“  ”. Press once to turn on the Open Window function, the LCD screen displays icon  , the indicator  on the machine lights yellow. Press again to turn it off, the LCD screen does not display icon  and the indicator  on the machine goes off. The buzzer beeps when the key is pressed;

After the Open Window function is turned on, the program firstly detects if the heating function is turned on. If it is turned on, the program will save the current ambient temperature value and detects the ambient temperature change once per 12 minutes. When the decrease in the ambient temperature detected within 30 minutes exceeds 4 °C ,the program will deem that the window is open and stop heating, and the Open Window indicator  on the machine will flash rapidly. After it has stopped heating for 70 minutes, the program starts to detect if the window is closed, and the indicator  flashes slowly. It heats for 6 minutes every 30 minutes (position H2). If the temperature rise is more than 2 °C , the window is considered as closed, and the indicator  stops flashing.

CARE AND MAINTENANCE

1. Switch off and unplug from the power supply before cleaning.
2. Using a soft, moist cloth, with or without a mild soap solution, carefully clean the exterior surface of the products.

CAUTION: Allow the product to completely cool before handling or cleaning it.

3. Do not allow water or other liquids to run into the interior of the product, as this could create a fire and/or electrical hazard.
4. We also recommend the periodic cleaning of this appliance by lightly running a vacuum cleaner nozzle over the guards to remove any dust or dirt that may have accumulated inside or on the unit.

CAUTION: Do not use harsh detergents, chemical cleaners or solvents as they may damage the surface finish of the plastic components.

CONFORMITY WITH DIRECTIVES

Conforms to all relevant European directives



ENVIRONMENTAL PROTECTION



Recycling

This symbol is known as the 'Crossed-out Wheeie Bin Symbol'. When this symbol is marked on a product or battery, it means that it should not be disposed of with your general household waste. Some chemicals contained within electrical/electronic products or batteries can be harmful to health and the environment.

Only dispose of electrical/electronic/battery items in separate collection schemes, which cater for the recovery and recycling of materials contained within. Your co-operation is vital to ensure the success of these schemes and for the protection of the environment.

REPLACEMENT PARTS

This list contains replacement parts

NO.	PART NUMBER			DESCRIPTION	QTY
	TRD-26	TRD-30	TRD-33		
1	10702245	10702247	10702249	BOTTOM GLASS	
2	10701375	10701376	10701377	FRONT CLEAR GLASS	
3	3215501	3216501	3217501	TRIM	
4				SIDE STEEL PANEL	
5	10702244	10702246	10702248	BACK GLASS	
6				BOX	
7		301506		REMOTE RECEIVER	
8		601095F		CIRCUIT BOARD	
9		602131B		BLOWER AND HEATER ASSEMBLY	
10		10101221C		FLAME MOTOR	
11	3085504E	3087504E	3089504E	FLICKER ASSEMBLYLED STRIP	
12	601136B	601136B	601136B	LED STRIP	2/2/2
12	601141B	601141B	601141B	LED STRIP	2/2/2
12				LED STRIP	
13		10125025		CANOPY LIGHT	
14		101050203		REMOTE CONTROL	

*Remote control and canopy light are not shown in the exploded view.

This list contains replacement parts

NO.	PART NUMBER			DESCRIPTION	QTY
	TRD-38	TRD-44	TRD-48		
1	10702251	10701379	10702255	BOTTOM GLASS	
2	10701378	10701379	10701380	FRONT CLEAR GLASS	
3	3218501	3219501	3220501	TRIM	
4				SIDE STEEL PANEL	
5	10702250	10702252	10702254	BACK GLASS	
6				BOX	
7	301506			REMOTE RECEIVER	
8	601095F			CIRCUIT BOARD	
9	602131B			BLOWER AND HEATER ASSEMBLY	
10	10101221C			FLAME MOTOR	
11	3218507	3219507	3220507	FLICKER ASSEMBLY LED STRIP	
12	601136B	601136B	601136B	LED STRIP	3/2/2
12	601137B	601137B	601137B	LED STRIP	0/1/1
12	601141B	601141B	601141B	LED STRIP	3/3/3
13	10125019	10125021	10125021	CANOPY LIGHT	
14	101050203			REMOTE CONTROL	

*Remote control and canopy light are not shown in the exploded view.

EXPLODED VIEW

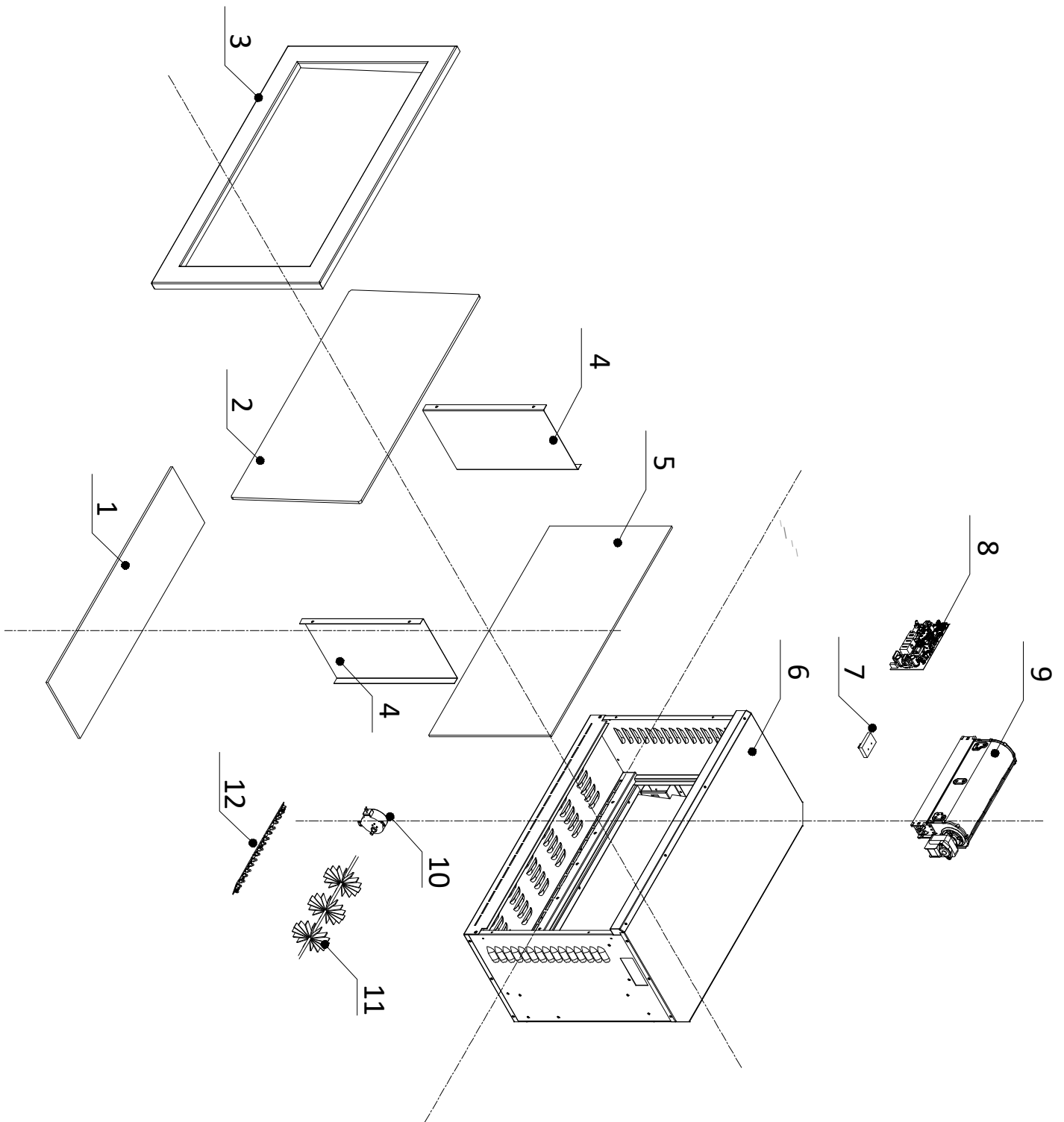

TROUBLE SHOOTING

PROBLEM	POSSIBLE CAUSE	SOLUTION
Dim or no flame	Flame LED's are burnt out.	Inspect the LED's and replace them if necessary.
	Back black cloth is falling off and rolled up in the flicker.	Change a flicker and back black cloth.
Ember bed is not glowing or dimming	Ember LED's are burnt out	Inspect the ember bed LED's and replace them if necessary.
Appliance turns off and will not turn on	Appliance has overheated, and safety device has caused the thermal switch to disconnect.	Turn off the main switch, allow appliance to cool for 10 minutes, turn back on.
	House circuit breaker has tripped.	Reset house circuit breaker.
	Appliance's fuse has blown.	Replace the fuse.
Appliance will not come on when switch is flipped to ON	Appliance is not plugged into an electrical outlet.	Check plug and plug in.
	Appliance has overheated and safety device has caused the thermal switch to disconnect.	Turn off the main switch, allow appliance to cool for 10 minutes, turn back on.
	Circuit board is burnt out.	Inspect the circuit board and replace it if necessary.
No warm air coming out of appliance	Heater is burnt out.	Inspect the burner and heater assembly and replace it if necessary.
Flame sputters	Flame motor is defective.	Call a qualified service technician and replace flame motor.
Remote Control does not work.	Low batteries. Unit switch in "O" position.	Replace AAA batteries in remote control. Turn the switch in "I" position.
Flame is fixed.	Wiring may be loose or the flame motor may be defective.	

SERVICE HISTORY

This heater must be serviced annually depending on usage.

Date	Dealer Name	Service technician Name	Service Performed	Special Concerns

NOTES:



WARRANTY FOR PRODUCTS MANUFACTURED AFTER JANUARY 1st, 2016

Amantii Imports Corp. ("Amantii ") warrants that your newly purchased Amantii electric fireplace is free from manufacturing and material defects for a period of two (2) years from the date of the first purchase, subject to the conditions and limitations contained below.

Warranty Application & Exclusions

This limited warranty applies to your newly purchased Amantii electric fireplace; the limited warranty's application is limited to purchases made in any province of Canada or in any of the 52 States of the United States of America, including the District of Columbia. Only the original purchaser of the product is eligible for coverage under this limited warranty; the warranty is not transferable.

Products excluded from this limited warranty

Light bulbs are not covered by this limited warranty and are the sole responsibility of the owner/ purchaser. Amantii does not cover service or labor charges.

Warranty Coverage and Term

Products covered by this limited warranty have been tested and inspected prior to shipment and, subject to the provisions of this warranty, Amantii warrants such products to be free from defects in material and workmanship for a period of two (2) years from the date of the first purchase of such products.

The limited two (2) year warranty period for products also applies to any implied warranties that may exist under applicable law. Some jurisdictions do not allow limitations on how long an implied warranty lasts, so the above limitation may not apply to the purchaser.

All other warranties-expressed or implied-with respect to the product, its components and accessories or any obligation/liabilities on the part of Amantii are hereby expressly excluded.

Limitations to Coverage Under Limited Warranty

This limited warranty does not apply to products that have been repaired, except by Amantii or its authorized service representatives, or otherwise altered. This limited warranty further does not apply to defects resulting from misuse, abuse, accident, neglect, incorrect installation, improper maintenance or handling, or operation with an incorrect power source. Products made by other manufacturers, sold with the product or thereafter, are not covered by this limited warranty. The use of unauthorized components will render this warranty null and void.

Panorama Outdoor Units

All Panorama units that are installed outdoors or in moisture intense conditions must use the stainless steel cover. Proof of purchase of the cover is required for any warranty claims.

Defects

Defects must be brought to the attention of the selling dealer. Please have your proof of purchase, catalogue/model and serial numbers available when contacting dealer; any and all service under the limited warranty requires a proof of purchase of the product. Should a product or part covered by this limited warranty be proven to be defective, in material or workmanship, and during the two (2) year limited warranty period, Amantii will replace such defective product or part without charge. If Amantii is unable to replace such product, or if replacement is not commercially practicable or cannot be timely done, in its sole discretion Amantii may, in lieu of replacement, choose to refund the purchase price for such product or part. Amantii does not cover labor or service charges to replace said parts.

Limitations

In no event will Amantii, including without limitation any of its directors, officers, shareholders, employees, consultants, agents, heirs, executors, administrators and assigns, be liable to the purchaser or any third party, whether in contract, in tort, or on any other basis for any indirect, special, punitive, exemplary, consequential, or incidental loss, cost or damage arising out of or in connection with the sale, maintenance, use or inability to use the product, even if Amantii, including without limitation any of its directors, officers, shareholders, employees, consultants, agents, heirs, executors, administrators and assigns, have been advised of the possibility of such losses, costs or damages, or if such losses, costs or damages are foreseeable. In no event will Amantii, including without limitation any of its directors, officers, shareholders, employees, consultants, agents, heirs, executors, administrators and assigns, be liable for any direct losses, costs or damages that exceed the purchase price of the product.

Some jurisdictions do not allow the exclusion or limitation of incidental or consequential damages, so the above limitation or exclusion may not apply to the purchaser.

Application of Provincial and State Law

This limited warranty gives you specific legal rights, and you may also have other rights which vary from jurisdiction to jurisdiction. The provisions of the United Nations Convention on Contracts for the Sale of Goods shall not apply to this limited warranty or the sale of products covered by this limited warranty.

General

Amantii reserves the right to make changes at any time without notice, in design, material, specifications, prices and the right to discontinue styles and products.