



# Electric Coil & Ceramic Top Ranges

Safety Information ..... 2-6

**Operating Instructions**

Surface Units ..... 7

Cookware ..... 8

Oven ..... 9

Oven ..... 11, 12

Thermostat ..... 10

Care and Cleaning ..... 11-16

Installation Instructions ..... 18-25

Troubleshooting Tips ..... 26-29

Accessories ..... 30

Warranty ..... 31-32

## Owner's Manual and Installation Instructions

Coil Top and Ceramic Top Models

**Write the model and serial numbers here:**

**Model #** \_\_\_\_\_

**Serial #** \_\_\_\_\_

You can find them on a label behind the storage drawer on the oven frame.



# IMPORTANT SAFETY INFORMATION. READ ALL INSTRUCTIONS BEFORE USING.

- ⚠ WARNING! READ ALL SAFETY INSTRUCTIONS BEFORE USING THE PRODUCT. FAILURE TO FOLLOW THESE INSTRUCTIONS MAY RESULT IN FIRE, ELECTRIC SHOCK SERIOUS INJURY OR DEATH.**

## ANTI-TIP DEVICE

### ⚠ WARNING



#### Tip-Over Hazard

A child or adult can tip the range and be killed. Verify the anti-tip bracket has been properly installed and engaged.

Ensure the anti-tip bracket is re-engaged when the range is moved.

Do not operate the range without the anti-tip bracket in place and engaged.

Failure to follow these instructions can result in death or serious burns to children or adults.

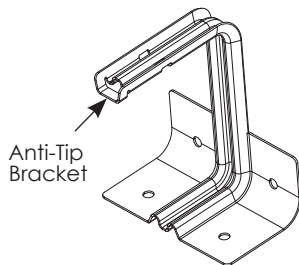

Free-Standing Ranges

To reduce the risk of tipping the range, the range must be secured by a properly installed anti-tip bracket. See installation instructions shipped with the bracket for complete details before attempting to install.

#### For Freestanding Ranges

To check if the bracket is installed and engaged properly, look underneath the range to see that the anti-tip arm attached to the side panel is engaged in the bracket. On some models, the storage drawer or kick panel can be removed for easier inspection. If visual inspection is not possible, slide the range forward, confirm the anti-tip bracket is securely attached to the floor or wall, and slide the range back so the antitip arm slides just under the anti-tip bracket. If the range is pulled from the wall for any reason, always repeat this procedure to verify the range is properly secured by the anti-tip bracket.

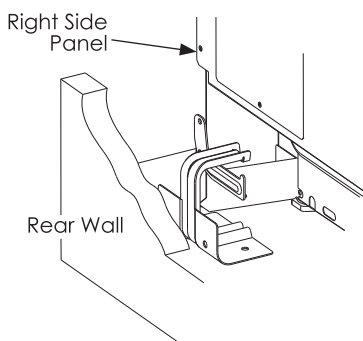



## COOK MEAT AND POULTRY THOROUGHLY...

Cook meat and poultry thoroughly—meat to at least an INTERNAL temperature of 160° F and poultry to at least an INTERNAL temperature of 180°F. Cooking to these temperatures usually protects against foodborne illness.



### **⚠** WARNING SAFETY PRECAUTIONS

- Never wear loose-fitting or hanging garments while using the appliance. Be careful when reaching for items stored over the range. Flammable material could be ignited if brought in contact with hot surface units or heating elements and may cause severe burns.
  - Use only dry pot holders—moist or damp pot holders on hot surfaces may result in burns from steam. Do not let pot holders touch hot surface units or heating elements. Do not use a towel or other bulky cloth.
  - For your safety never use your appliance for warming or heating the room.
  - Do not let cooking grease or other flammable materials accumulate in or near the range.
  - Do not use water on grease fires. Never pick up a flaming pan. Turn the controls off. Smother a flaming pan on a surface unit by covering the pan completely with a well fitting lid, cookie sheet or flat tray. Use a multipurpose dry chemical or foam-type fire extinguisher.
- Flaming grease outside a pan can be put out by covering it with baking soda or, if available, by using a multipurpose dry chemical or foam type fire extinguisher. Flame in the oven can be smothered completely by closing the door and turning the oven off or by using a multipurpose dry chemical or foam type fire extinguisher.
- Do not touch the surface units, the heating elements or the interior surface of the oven. These surfaces may be hot enough to burn even though they are dark in color. During and after use, do not touch or let clothing or other flammable materials contact the surface units, areas nearby the surface units or any interior area of the oven; allow sufficient time for cooling first.
- Potentially hot surfaces include the cooktop, areas facing the cooktop, oven vent opening, surfaces near the opening, crevices around the oven door and metal trim parts above the door.
- REMEMBER:** The inside surface of the oven may be hot when the door is opened.
- Do not store or use combustible materials, gasoline or other flammable vapors and liquids in the vicinity of this or any other appliance.
  - Keep the hood and grease filters clean to maintain good venting and to avoid grease fires.
  - Never block the vents (air openings) of the range. They provide the air inlet and outlet that are necessary for the range to operate properly with correct combustion. Air openings are located at the rear of the cooktop, at the top and bottom of the oven door, and at the bottom of the range under the storage drawer.

# IMPORTANT SAFETY INFORMATION.

## READ ALL INSTRUCTIONS BEFORE USING.



### ⚠ WARNING

#### OVEN

- Stand away from the range when opening the oven door. Hot air or steam which escapes can cause burns to hands, face and/or eyes.
- Do not heat unopened food containers. Pressure could build up and the container could burst, causing an injury. Keep the oven vent unobstructed.
- Keep the oven free from grease buildup.
- Place the oven shelf in the desired position while the oven is cool. If shelves must be handled when hot, do not let pot holder contact the heating elements.
- Pulling out the shelf to the stop-lock is a convenience in lifting heavy foods. It is also a precaution against burns from touching hot surfaces of the door or oven walls.
- When using cooking or roasting bags in the oven, follow the manufacturer's directions.
- Do not use the oven to dry newspapers. If overheated, they can catch on fire.
- Do not use the oven for a storage area. Items stored in an oven can ignite.
- Do not leave paper products, cooking utensils or food in the oven when not in use.



### ⚠ WARNING

#### SURFACE UNITS-ALL MODELS

*Use proper pan size-select cookware having flat bottoms large enough to cover the surface unit heating element. The use of undersized cookware will expose a portion of the surface unit to direct contact and may result in ignition of clothing. Proper relationship of cookware to surface unit will also improve efficiency.*

- Never leave the surface units unattended at high heat settings. Boilovers cause smoking and greasy spillovers that may catch on fire.
- Only certain types of glass, glass/ceramic, earthenware or other glazed containers are suitable for cooktop service, others may break because of the sudden change in temperature.
- To minimize the possibility of burns, ignition of flammable materials and spillage, the handle of a container should be turned toward the center of the range without extending over nearby surface units.
- Always turn the surface units off before removing cookware.
- Do not flame foods on the cooktop. If you do flame foods under the hood, turn the fan on.
- Keep an eye on foods being fried at high or medium high heat settings.
- Foods for frying should be as dry as possible. Frost on frozen foods or moisture on fresh foods can cause hot fat to bubble up and over the side of the pan.
- Use little fat for effective shallow or deep fat frying. Filling the pan too full of fat can cause spillovers when food is added.
- If a combination of oils or fats will be used in frying, stir together before heating, as fats melt slowly.
- Always heat fat slowly, and watch as it heats.
- Use a deep fat thermometer whenever possible to prevent overheating fat beyond the smoking point.

# IMPORTANT SAFETY INFORMATION.

## READ ALL INSTRUCTIONS BEFORE USING.



### **⚠ WARNING!** RADIANT SURFACE UNITS (on some models)

Use care when touching the cooktop. The glass surface of the cooktop will retain heat after the controls have been turned off.

- Avoid scratching the glass cooktop. The cooktop can be scratched with items such as sharp instruments, rings or other jewelry and rivets on clothing.
- Large scratches or impacts to glass doors or cooktops can lead to broken or shattered glass.
- Do not operate the radiant surface units if the glass is broken. Spillovers or cleaning solution may penetrate a broken cooktop and create a risk of electrical shock. Contact a qualified technician immediately should your glass cooktop become broken.
- Never use glass cooktop surface as a cutting board.
- Do not place or store items that can melt or catch fire on the glass cooktop, even when it is not being used.
- Be careful when placing spoons or other stirring utensils on the glass cooktop surface when it is in use. They may become hot and could cause burns.
- Clean the cooktop with caution. If a wet sponge or cloth is used to wipe spills on a hot surface unit, be careful to avoid steam burns. Some cleaners can produce noxious fumes if applied to a hot surface.  
**NOTE:** We recommend that you avoid wiping any surface unit areas until they have cooled and the indicator light has gone off. Sugar spills are the exception to this. Please see Cleaning the glass cooktop section.
- When the cooktop is cool, use only the recommended cleaning cream to clean the cooktop.
- To avoid possible damage to the cooking surface, do not apply cleaning cream to the glass surface when it is hot.
- After cleaning, use a dry cloth or paper towel to remove all cleaning cream residue.
- Read and follow all instructions and warnings on the cleaning cream labels.
- Do not lift the cooktop. Lifting the cooktop can lead to damage and improper operation of the range.

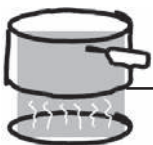

### **⚠ WARNING!** COIL SURFACE UNITS (on some models)

- Clean the cooktop with caution. If a wet sponge is used to wipe spills on a hot cooktop, be careful to avoid steam burns.
- To avoid the possibility of a burn or electric shock, always be certain that the controls for all surface units are at the OFF position and all coils are cool before attempting to lift or remove a unit.
- Do not immerse or soak the removable surface units. Do not put them in a dishwasher.
- Be sure the drip pans and the vent duct are not covered and are in place. Their absence during cooking could damage range parts and wiring.
- Do not use aluminum foil to line the drip pans or anywhere in the oven except as described in this manual. Misuse could result in a shock, fire hazard or damage to the range.



READ AND FOLLOW THIS SAFETY INFORMATION CAREFULLY  
**SAVE THESE INSTRUCTIONS**

## Using the surface units.

Throughout this manual, features and appearance may vary from your model.

### Surface Cooking Controls

Your surface units and controls are designed to give you a variety of heat settings for surface unit cooking.

At both LO and HI positions, there is a slight notch so control clicks at those positions; HI marks the highest setting; LO, the lowest setting.

In a quiet kitchen, you may hear slight clicking sounds during cooking, indicating heat settings selected are being maintained.

Switching heats to higher settings always shows a quicker change in temperature than switching to lower settings.

### How to Set the Controls

1. Push the control knob in.
2. Turn either clockwise or counterclockwise to desired heat setting.

Control must be pushed in to set only from the OFF position.

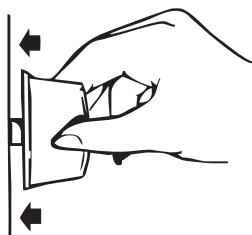

When control is in any position other than OFF, you can turn it without pushing in.

Be sure you turn control to OFF when you finish cooking. An indicator light will glow when ANY surface unit is on.

A Burner On indicator light will glow when ANY surface unit is on.

### Heat Setting Guide

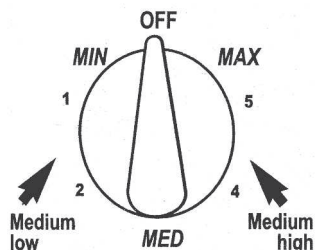

**MAX** - Quick start for cooking; bring water to boil.

**MEDIUM HIGH** - Fast fry, pan broil; maintain fast boil on large amount of food.

**MED** - Sauce and brown; maintain slow boil on large amount of food.

**MEDIUM LOW** - Cereal; maintain serving temperature of most foods.

**MIN** - Cook after starting at HI; cook with little water in covered pan. Use to steam rice.

#### NOTES:

1. At MAX or MEDIUM HIGH, never leave food unattended. Boilovers cause smoking; greasy spillovers may catch fire.
2. At MIN, melt chocolate, butter on small unit.

### Cooking Tips

Use medium- or heavyweight cookware. Aluminum cookware conducts heat faster than other metals. Cast-iron and coated cast-iron cookware is slow to absorb heat, but generally cooks evenly at low or medium heat settings. Steel pans may cook unevenly if not combined with other metals.

Do not overfill cookware with fat that may spill over when adding food. Frosty foods bubble vigorously. Watch foods frying at high temperatures. Keep range and hood clean from accumulated grease.

To conserve the most cooking energy, pans should be flat on the bottom, have straight sides and tight-fitting lids. Match the size of the saucepan to the size of the surface unit. A pan that extends more than an inch beyond the edge of the drip pan traps heat, which causes "crazing" (fine hairline cracks) on porcelain, and discoloration ranging from blue to dark gray on chrome drip pans.

# Using the surface units.

Throughout this manual, features and appearance may vary from your model.

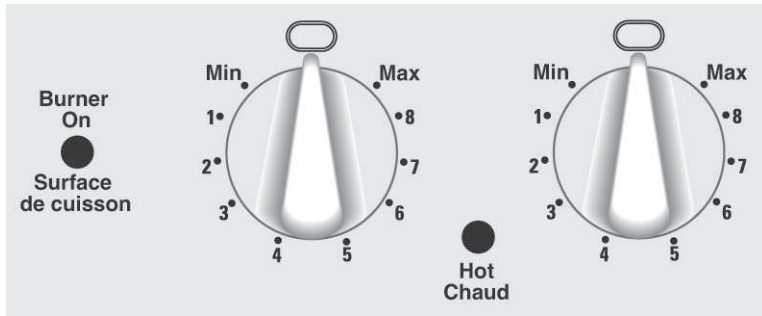

## Indicator Lights (on radiant glass models only).

A **Hot** indicator light will glow when any radiant element is turned on, and will remain on until the surface is cool enough to touch.

A **Burner On** indicator light will glow when any surface unit is on.

**NOTE:** The Hot indicator light may glow between the surface control settings of Min and OFF, but there is no power to the surface units.

# Using the radiant surface units. (on some models)



Never cook directly on the glass. Always use cookware.

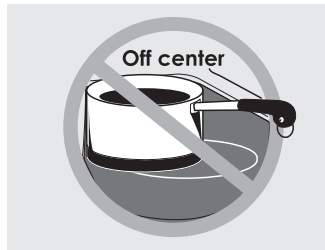

Always place the pan in the center of the surface unit you are cooking on.

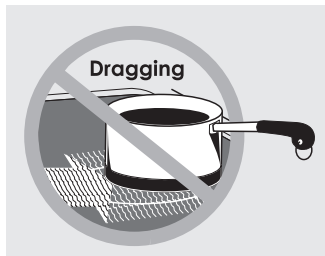

## About the radiant surface units...

The radiant cooktop features heating units beneath a smooth glass surface.

**NOTE:** A slight odor is normal when a new cooktop is used for the first time. It is caused by the heating of new parts and insulating materials and will disappear in a short time.

The surface unit will cycle on and off to maintain your selected control setting.

It is safe to place hot cookware from the oven or surface on the glass surface when the surface is cool.

Even after the surface units are turned off, the glass cooktop retains enough heat to continue cooking. To avoid overcooking, remove pans from the surface units when the food is cooked. Avoid placing anything on the surface unit until it has cooled completely.

Do not slide cookware across the cooktop because it can scratch the glass - the glass is scratch resistant, not scratch proof.

- Water stains (mineral deposits) are removable using the cleaning cream or full-strength white vinegar.
- Use of window cleaner may leave an iridescent film on the cooktop. The cleaning cream will remove this discoloration.
- Do not store heavy items above the cooktop. If they drop onto the cooktop, they can cause damage.
- Do not use the surface as a cutting board.

## Temperature Limiter

Every radiant surface unit has a temperature limiter. The temperature limiter protects the glass cooktop from getting too hot.

The temperature limiter may cycle the units off for a time if:

- The pan boils dry.
- The pan bottom is not flat.
- The pan is off center.
- There is no pan on the unit.

# Selecting types of cookware.

The following information will help you choose cookware that will give good performance on glass cooktops.

Safety Instructions

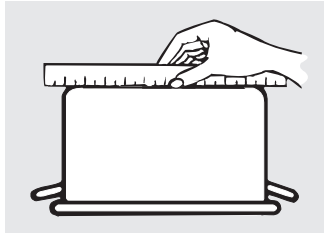

Check for flat bottoms by using a straight edge.

Operating Instructions



Pans with rounded, curved, ridged or warped bottoms are not recommended.

Care and Cleaning

Installation Instructions

**Stainless Steel:**  
*recommended*

**Aluminum:**  
*heavy weight recommended.*  
Good conductivity. Aluminum residues sometimes appear as scratches on the cooktop, but can be removed if cleaned immediately. Because of its low melting point, thin-weight aluminum should not be used.

**Copper Bottom:**  
*recommended*

Copper may leave residues which can appear as scratches. The residues can be removed, as long as the cooktop is cleaned immediately. However, do not let these pots boil dry. Overheated metal can bond to glass cooktops. An overheated copper bottom pot will leave a residue that will permanently stain the cooktop if not removed immediately.

**Porcelain Enamel Covered Cast Iron:**  
*recommended*

As long as the cookware is covered completely with porcelain enamel, this cookware is recommended. Caution is recommended for cast-iron cookware that is not completely covered with smooth porcelain enamel, as it may scratch the glass-ceramic cooktop.

**Glass-ceramic:**

usable, but not recommended  
Poor performance. May scratch the surface.

**Stoneware:**

usable, but not recommended  
Poor performance. May scratch the surface.

**Home Canning Tips:**

Be sure the canner is centered over the surface unit.

Make sure the canner is flat on the bottom.

Use recipes and procedures from reputable sources. These are available from manufacturers such as Ball® and Kerr® and the Department of Agriculture Extension Service.

To prevent burns from steam or heat, use caution when canning.



The following information will help you choose cookware which will give good performance on coil cooktops.

Troubleshooting Tips

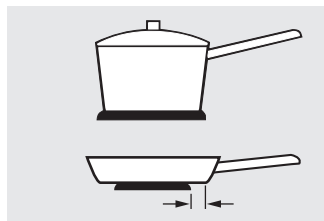

Not over 1 inch

## Surface Cookware Tips

Use medium- or heavy-weight cookware. Aluminum cookware conducts heat faster than other metals. Cast-iron and coated cast-iron cookware are slow to absorb heat, but generally cook evenly at low to medium heat settings. Steel pans may cook unevenly if not combined with other metals.

For best cooking results, pans should be flat on the bottom. Match the size of the saucepan to the size of the surface unit. The pan should not extend over the edge of the surface unit than 1 inch.

Consumer Support

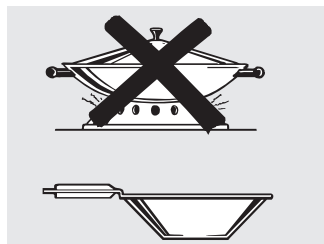

Use only flat-bottomed woks

## Wok Cooking

*We recommend that you use only a flat-bottomed wok.*

They are available at your local retail store. Do not use woks that have support rings. Use of these types of woks, with or without the ring in place, can be dangerous.

Placing the ring over the surface unit will cause a buildup of heat that will damage the porcelain cooktop. Do not try to use such woks without the ring. You could be seriously burned if the wok tips over.

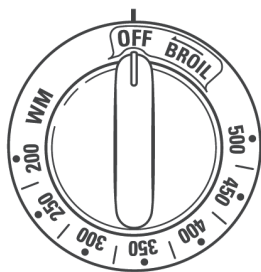

### Oven Temperature Knob (on some models)

Turn this knob to the setting you want.

The oven cycling light glows until the oven reaches your selected temperature, then goes off and on with the oven element(s) during cooking.

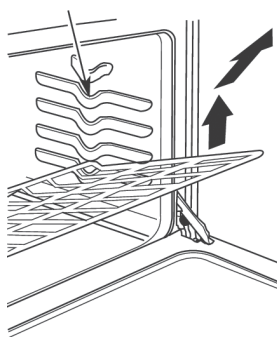

### Before you begin...

To avoid possible burns, place the shelves in the desired position before you turn the oven on.

The shelves have stop-locks, so that when placed correctly on the shelf supports (A through D), they will stop before coming completely out, and will not tilt.

When placing and removing cookware, pull the shelf out to the bump on the shelf support.

**To remove a shelf**, pull it toward you, tilt the front end up and pull it out.

**To replace**, place the end of the shelf (stop-locks) on the support, tilt up the front and push the shelf in.

**NOTE:** The shelf is not designed to slide out at the special low shelf (R) position.

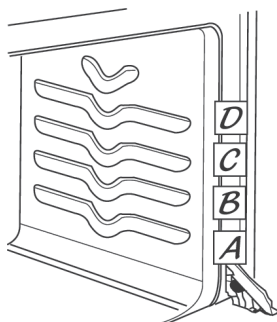

### Oven shelf positions

The oven has four shelf supports—A (bottom), B, C and D (top).

The oven has 4 shelf positions.

### Preheating and Pan Placement

Preheat the oven if the recipe calls for it. To preheat, set the oven at the correct temperature. Preheating is necessary for good results when baking cakes, cookies, pastry and breads.

For ovens without a preheat indicator light or tone, preheat 10 minutes.

Baking results will be better if baking pans are centered in the oven as much as possible. Pan should not touch each other or the walls of the oven. If you need to use two shelves, stagger the pans so one is not directly above the other, and leave approximately 1 1/2" between pans, from the front, back and sides of the wall.

### Aluminum Foil

Do not use aluminum foil on the bottom of the oven.

Never entirely cover a shelf with aluminum foil. This will disturb the heat circulation and result in poor baking.

A smaller sheet of foil may be used to catch a spillover by placing it on a lower shelf several inches below the food.

## Adjust the oven thermostat – Easy to do yourself!

You may find that your new oven cooks differently than the one it replaced. Use your new oven for a few weeks to become more familiar with it. If you still think your new oven is too hot or too cold, you can adjust the thermostat yourself. Do not use thermometers, such as those found in grocery stores, to check the temperature setting of your oven. These thermometers may vary 20-40°F.

**NOTE:** This adjustment will not affect the broiling or the self-cleaning temperatures (on some models). The adjustment will be retained in memory after a power failure.

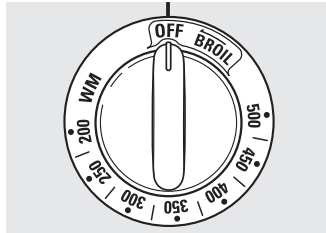

Front of OVEN TEMP knob (knob appearance may vary).

### To Adjust the Thermostat with this Type of Knob

1. Pull the Oven Temp knob off the shaft, look at the back of the knob and note the current setting before making any adjustments.
2. Loosen both screws on the back of the knob.
3. To increase the oven temperature, move the pointer toward the words "MAKE HOTTER."

Each notch changes the temperature by 10°F.

4. Tighten the screws.
5. Replace the knob matching the flat area of the knob to the shaft.

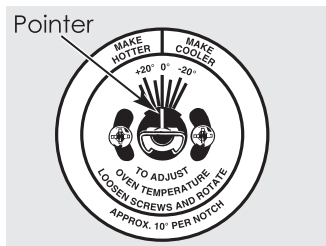

Back of OVEN TEMP knob.

To decrease the oven temperature, turn the pointer toward the words "MAKE COOLER."

## The type of margarine will affect baking performance!

*Most recipes for baking have been developed using high fat products such as butter or margarine (80% fat). If you decrease the fat, the recipe may not give the same results as with a higher fat product.*

Recipe failure can result if cakes, pies, pastries, cookies or candies are made with low fat spreads. The lower the fat content of a spread product, the more noticeable these differences become.

Federal standards require products labeled "margarine" to contain at least 80% fat by weight. Low-fat spreads, on the other hand, contain less fat and more water. The high moisture content of these spreads affects the texture and flavor of baked goods. For best results with your old favorite recipes, use margarine, butter or stick spreads containing at least 70% vegetable oil.

## Using the self-cleaning oven. *(on some models)*

The oven door must be closed and all controls must be set correctly for the cycle to work properly.

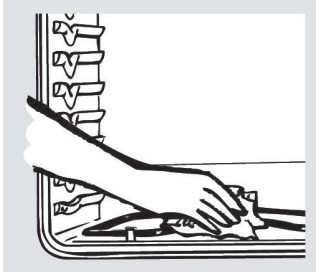

Wipe up heavy soil on the oven bottom (appearance may vary).

### Before a Clean Cycle

The oven must be cool in order to set the self-clean cycle.

We recommend venting your kitchen with an open window or using a ventilation fan or hood during the first self-clean cycle.

Remove broiler pan, broiler grid, all cookware and any aluminum foil from the oven.

The shiny, silver-colored oven shelves (on some models) can be self-cleaned, but they will darken, lose their luster and become hard to slide.

Do not use abrasives or oven cleaners. Clean the top, sides and outside of the oven door with soap and water.

Make sure the oven light bulb cover (on some models) is in place and the oven light is off.

**IMPORTANT:** The health of some birds is extremely sensitive to the fumes given off during the self-cleaning cycle of any oven. Move birds to another well ventilated room.

## Care and cleaning of the range.

Be sure electrical power is off and all surfaces are cool before cleaning any part of the range.

	<b>⚠ WARNING</b>
	<p><b>Tip-Over Hazard</b> A child or adult can tip the range and be killed. Verify the anti-tip bracket has been properly installed and engaged.</p> <p>Ensure the anti-tip bracket is re-engaged when the range is moved.</p> <p>Do not operate the range without the anti-tip bracket in place and engaged.</p> <p>Failure to follow these instructions can result in death or serious burns to children or adults.</p>

### Oven Interior (on standard-clean models)

With proper care, the porcelain enamel finish on the inside of the oven - top, bottom, sides, back and inside of the door- will stay new-looking for years.

Let the range cool before cleaning. We recommend that you wear rubber gloves when cleaning the range.

Soap and water will normally do the job. Heavy spattering or spillovers may require cleaning with a mild abrasive cleaner. Soap-filled scouring pads may also be used.

**IMPORTANT:** Do not allow food spills with a high sugar or acid content (such as milk, tomatoes, sauerkraut, fruit juices or pie filling) to remain on the surface. They may cause a dull spot even after cleaning.

Household ammonia may make the cleaning job easier. Place 1/2 cup in a shallow glass or pottery container in a cold oven overnight. The ammonia fumes will help loosen the burned-on grease and food.

If necessary, you may use an oven cleaner. Follow the package directions.

Do not spray oven cleaner on the electrical controls and switches because it could cause a short circuit and result in sparking or fire.

Do not allow a film from the cleaner to build up on the temperature sensor- it could cause the oven to heat improperly. (The sensor is located at the top of the oven.) Carefully wipe the sensor clean after each oven cleaning, being careful not to move the sensor as a change in its position could affect how the oven bakes.

Do not spray any oven cleaner on the oven door, handles or any exterior surface of the oven, cabinets or painted surfaces. The cleaner can damage these surfaces.

**To clean the inside of the door:**

- Do not allow excess water to run into any holes or slots in the door.
- Soap and water will normally do the job. Heavy spattering or spillovers may require cleaning with a mild abrasive cleaner. Soap-filled, steel-wool pads may also be used.

Do not allow food spills with a high sugar or acid content (such as milk, tomatoes, sauerkraut, fruit juices or pie filling) to remain on the surface. They may cause a dull spot even after cleaning.

**To clean the outside of the door:**

- Use soap and water to thoroughly clean the top, sides and front of the oven door. Rinse well. You may also use a glass cleaner to clean the glass on the outside of the door. Do not let water drip into the vent openings.
- Spillage of marinades, fruit juices, tomato sauces and basting materials containing acids may cause discoloration and should be wiped up immediately. When surface is cool, clean and rinse.
- Do not use oven cleaners, cleaning powders or harsh abrasives on the outside of the door.

**To clean outside of the gasket:**

The gasket is designed with a gap at the bottom to allow for proper air circulation.

Because the area inside the gasket is cleaned during the self-clean cycle, you do not need to clean this by hand on self-clean models.

The area outside the gasket and the front frame can be cleaned with a soap-filled steel-wool pad, hot water and detergent. Rinse well with a vinegar and water solution.

Do not rub or clean the door gasket-it has an extremely low resistance to abrasion.

If you notice the gasket becoming worn, frayed or damaged in any way, or if it has become displaced on the door, you should have it replaced.

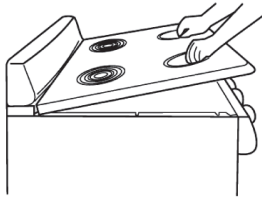
**Lift-up Cooktop (only coil models)**

Clean the area under the cooktop often. Builtup soil, especially grease, may catch on fire.

To make cleaning easier, the cooktop may be lifted up and propped open.

Be sure all surface units are turned off before raising the cooktop.

Remove the front surface and drip pans. See the Surface Units and Drip Pans section. Grasp the two front surface unit wells

and lift the cooktop up and prop it open with the prop rod provided.

After cleaning underneath the cooktop with hot, soapy water and a clean cloth, hold the cooktop up, return the prop rod to its storage position and lower the cooktop until it snaps into position. Be careful not to pinch your fingers. Replace the two front drip pans and surface units. See the Surface Units and Drip Pans section.

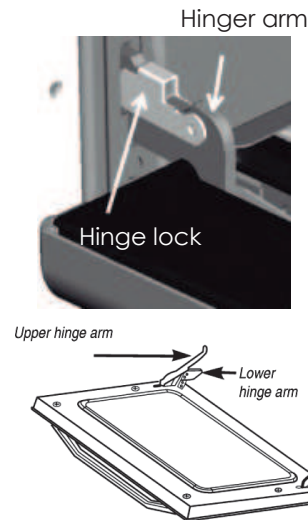
**Lift-Off Oven Door**

The oven door is removable, but it is heavy. You may need help removing and replacing the door.

**To remove the door:**

1. Open the door to the full open position.
2. Pull the hinge locks up over the hinge hooks on both sides.
3. Grasp the door firmly on each side, lift slightly and pull it straight out and away from the oven.

**To replace the door:**

1. Firmly grasp both sides of the door at the top.
2. Insert and seat the upper and lower hinge arms into the oven slots.
3. Push the hinge locks down from the hinge hooks.
4. Close the oven door and make sure it is working properly. If it is not working properly, remove and replace it following the above steps. **DO NOT ATTEMPT TO CLOSE THE DOOR UNTIL THIS STEP IS COMPLETE. THE HINGE OR DOOR COULD BE DAMAGED.**

# Care and cleaning of the range.

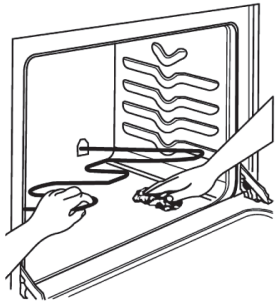

## Oven Heating Elements

Do not clean the bake element or the broil element. Any soil will burn off when the elements are heated.

The bake elements can be lifted gently to clean the oven floor. Do not attempt to clean any oven surface when any burner element is on. Always wear protective hand-wear when cleaning interior oven surfaces or surfaces near heating ele-

ments. If spillovers, residue or ash accumulate around the bake element, gently wipe around the element with warm water.

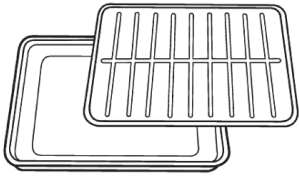

Both the broiler pan and grid can also be cleaned in the dishwasher.

## Broiler Pan and Grid

After broiling, remove the broiler pan from the oven. Remove the grid from the pan. Carefully pour out grease from the pan into a proper container. Wash and rinse the broiler pan and grid in hot water with a soap-filled or plastic scouring pad.

If food has burned on, sprinkle the grid with detergent while hot and cover with wet paper towels or a dishcloth. Soaking the pan will remove burned on foods.

Do not store a soiled broiler pan and grid anywhere in the range.

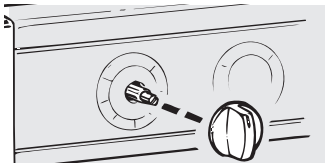

Pull the knobs straight off the stem.

## Control Panel and Knobs

It is a good idea to wipe the control panel after each use of the oven. Use a damp cloth to clean or rinse. For cleaning, use mild soap and water or a 50/50 solution of vinegar and water. For rinsing, use clean water. Polish dry with a soft cloth.

Do not use abrasive cleaners, strong liquid cleaners, plastic scouring pads or oven cleaners on the control panel; they will damage the finish.

The control knobs may be removed for easier cleaning.

Make sure the knobs are in the OFF positions and pull them straight off the stems for cleaning.

The knobs can be cleaned in a dishwasher or they may also be washed with soap and water. Make sure the insides of the knobs are dry before replacing.

Replace the knobs in the OFF position to ensure proper placement.

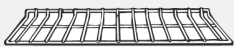

## Oven Shelves

Clean the oven shelves with an abrasive cleanser or scouring pad. After cleaning, rinse the shelves with clean water and dry with a clean cloth.

**NOTE:** Take the shelves out of the oven before you begin the self-clean cycle or they may discolor.

To make the shelves slide more easily, apply a small amount of vegetable oil or cooking oil to a paper towel and wipe the edges of the oven shelves with the paper towel.

# Care and cleaning of the range.

Safety Instructions

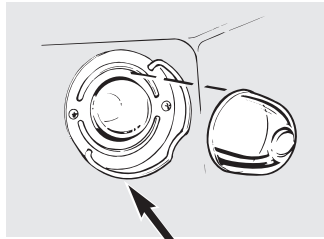

Wire cover holder

## Oven Light Replacement (on some models)

**⚠ CAUTION:** Before replacing your oven light bulb, turn the oven light off and disconnect the electrical power to the range at the main fuse or circuit breaker panel.

Be sure to let the light cover and bulb cool completely.

### To remove the cover:

1. Hold a hand under the cover so it does not fall when released. With fingers of the same hand, firmly push back the wire cover holder. Lift off the cover.

*Do not remove any screws to remove the cover.*

2. Replace bulb with a 40-watt household appliance bulb.

### To replace the cover:

1. Place it into groove of the light receptacle. Pull wire forward to the center of the cover until it snaps into place.
2. Connect electrical power to the range.

Operating Instructions

Care and Cleaning

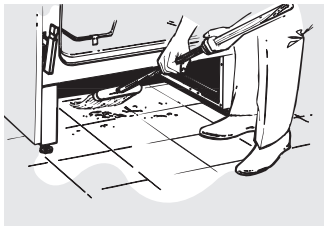

Clean under the range

## Storage Drawer Removal (on some models)

### To remove the storage drawer:

1. Pull the drawer out all the way.
2. Tilt up the front and remove it.

### To replace the storage drawer:

1. Insert glides at the back of the drawer beyond the stop on range glides.
2. Lift the drawer if necessary to insert easily.
3. Let the front of the drawer down, then push in to close.

Installation Instructions

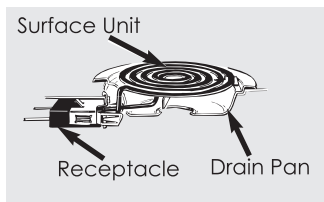

Surface Unit

Receptacle Drain Pan

## Surface Units (on some models)

Be sure all the controls are turned to OFF and the surface units are cool before attempting to remove them.

To clean the surface units, turn the control to the highest setting for a minute. The coils will burn off any soil.

### To remove a surface unit:

To remove the drip pans for cleaning, the surface units must be removed first.

Lift the surface unit about 1 inch above the drip pan and pull it out.

Do not lift the surface unit more than 1". If you do, it may not lie flat on the drip pan when you plug it back in.

Repeated lifting of the surface unit more than 1 inch above the drip pan can permanently damage the receptacle.

### To replace a surface unit:

Replace the drip pan into the recess in the cooktop. Make sure the opening in the pan lines up with the receptacle.

Insert the terminals of the surface unit through the opening in the drip pan and into the receptacle.

Guide the surface unit into place so it rests evenly.

*Do not immerse the surface units in liquids of any kind.*

*Do not clean the surface units in a dishwasher.*

*Do not bend the surface unit plug terminals.*

*Do not attempt to clean, adjust or in any way repair the plug-in receptacle.*

Troubleshooting Tips

Consumer Support

# Care and cleaning of the range.

## Drip Pans (if included)

Remove the surface units. Then lift out the drip pans.

Place them in a covered container. Add ¼ cup ammonia and let soak several hours or overnight. Wash, rinse well and dry.

The drip pans may also be cleaned in the dishwasher.

Clean the area under the drip pans often. Built-up soil, especially grease, may catch fire.

*Do not cover the drip pans with foil. Using foil so close to the receptacle could cause shock, fire or damage to the range.*

**NOTE:** Do not clean the drip pans in a self-cleaning oven.

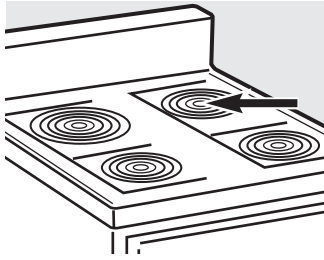

## Oven Vent

On glass cooktop models, the oven is vented through an opening at the rear of the cooktop.

On coil cooktop models, the oven is vented through an opening under the right rear surface unit.

**Never cover the opening with aluminum foil or any other material.**

## Painted Surfaces (on some models)

Painted surfaces include the sides of the range and the sides of the door trim.

To clean the painted surfaces, use a hot, damp cloth with a mild detergent suitable for these surfaces. Use a clean, hot, damp cloth to remove soap. Dry with a dry, clean cloth.

Do not use steel-wool pads, commercial oven cleaners, cleaning powders or other abrasive cleaners. They will damage the surface.

## Stainless Steel Surfaces (on some models)

Do not use a steel wool pad; it will scratch the surface.

To clean the stainless steel surface, use warm sudsy water or a stainless steel cleaner or polish. Always wipe the surface in the direction of the grain. Follow the cleaner instructions for cleaning the stainless steel surface.

## Glass Window (on some models)

To clean the outside glass finish, use a glass cleaner. Rinse and polish with a dry cloth.

# Cleaning the glass cooktop. *(on some models)*

Safety Instructions

Operating Instructions

Care and Cleaning

Installation Instructions

Troubleshooting Tips

Consumer Support



Clean your cooktop after each spill. Use Ceramic Cooktop Cleaner.

## Normal Daily Use Cleaning

**ONLY** use Ceramic Cooktop Cleaner on the glass cooktop. Other types of cleaners may not be as effective.

To maintain and protect the surface of your glass cooktop, follow these steps.

1. Before using the cooktop for the first time, clean it with Ceramic Cooktop Cleaner. This helps protect the top and makes cleanup easier.
2. Daily use of Ceramic Cooktop Cleaner will help keep the cooktop looking new.
3. Shake the cleaning cream well. Apply a few drops of Ceramic Cooktop Cleaner directly to the cooktop.

4. Use a paper towel for Ceramic Cooktops to clean the entire cooktop surface.

5. Use a dry cloth or paper towel to remove all cleaning residue. No need to rinse.

**NOTE:** It is very important that you **DO NOT** heat the cooktop until it has been cleaned thoroughly.

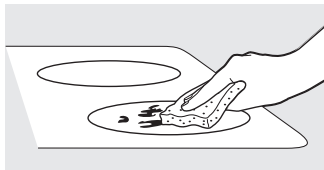

Use a Cleaning Pad for Ceramic Cooktops.

## Burned-On Residue

**⚠ WARNING: DAMAGE** to your glass surface may occur if you use scrub pads other than those recommended.

1. Allow the cooktop to cool.
2. Spread a few drops of Ceramic Cooktop Cleaner on the entire burned residue area.
3. Using the included Cleaning Pad for Ceramic Cooktops, rub the residue area, applying pressure as needed.
4. If any residue remains, repeat the steps listed above as needed.
5. For additional protection, after all residue has been removed, polish the entire surface with Ceramic Cooktop Cleaner and paper towel.

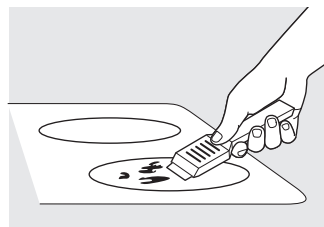

**Note:** Do not use a dull or nicked blade.

## Heavy Burned-On Residue

1. Allow the cooktop to cool.
2. Use a single-edge razor blade scraper at approximately a 45° angle against the glass surface and scrape the soil. It will be necessary to apply pressure to the razor scraper in order to remove the residue.
3. After scraping with the razor scraper, spread a few drops of Ceramic Cooktop Cleaner on the entire burned residue area. Use the Cleaning Pad to remove any remaining residue.
4. For additional protection, after all residue has been removed, polish the entire surface with Ceramic Cooktop Cleaner and a paper towel.

# Cleaning the glass cooktop. (on some models)

## Metal Marks and Scratches

1. Be careful not to slide pots and pans across your cooktop. It will leave metal markings on the cooktop surface.  
These marks are removable using the Ceramic Cooktop Cleaner with the Cleaning Pad for Ceramic Cooktops.
2. If pots with a thin overlay of aluminum or copper are allowed to boil dry the overlay may leave black discoloration on the cooktop.  
This should be removed immediately before heating again or the discoloration may be permanent.

**⚠ WARNING:** Carefully check the bottom of pans for roughness that would scratch the cooktop.

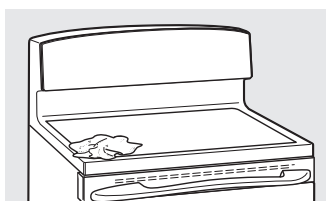

## Cooktop Seal

To clean the cooktop seal around the edges of the glass, lay a wet cloth on it for a few minutes, then wipe clean with non-abrasive cleaners.

## Glass surface – potential for permanent damage.

**Sugary spillovers (such as jellies, fudge, candy, syrups) or melted plastics can cause pitting of the surface of your cooktop (not covered by the warranty) unless the spill is removed while still hot.**

**Special care should be taken when removing hot substances.**

**Be sure to use a new, sharp razor scraper.**

**Do not use a dull or nicked blade.**

## Damage from Sugary Spills and Melted Plastic

1. Turn off all surface units. Remove hot pans.
2. Wearing an oven mitt:
  - a. Use a single-edge razor blade scraper to move the spill to a cool area on the cooktop.
  - b. Remove the spill with paper towels.
3. Any remaining spillover should be left until the surface of the cooktop has cooled.
4. Do not use the surface units again until all of the residue has been completely removed.

**NOTE: If pitting or indentation in the glass surface has already occurred, the cooktop glass will have to be replaced. In this case, service will be necessary.**

# Installation Instructions

## 20" & 24" Electric Ranges

### BEFORE YOU BEGIN

Read these instructions completely and carefully.

- **IMPORTANT** - Save these instructions for local inspector's use.
- **IMPORTANT** - Observe all governing codes and ordinances.
- **Note to Installer** - Be sure to leave these instructions with the Consumer.
- **Note to Consumer** - Keep these instructions for future reference.
- **Skill level** - Installation of this appliance requires basic mechanical skills.
- **Completion time** - 1 to 3 hours.
- Proper installation is the responsibility of the installer.
- Product failure due to improper installation is not covered under the Warranty.

**⚠ WARNING** - This appliance must be properly grounded.

### FOR YOUR SAFETY:

**⚠ WARNING** - Before beginning the installation, switch power off at service panel and lock the service disconnecting means to prevent power from being switched on accidentally. When the service disconnecting means cannot be locked, securely fasten a prominent warning device, such as a tag, to the service panel.

### FOR YOUR SAFETY:

All rough-in and spacing dimensions must be met for safe use of your range. Electricity to the range can be disconnected at the outlet without moving the range if the outlet is in the preferred location (remove lower drawer).

To reduce the risk of burns or fire when reaching over hot surface elements, cabinet storage space above the cooktop should be avoided. If cabinet storage space is to be provided above the cooktop, the risk can be reduced by installing a range hood that sticks out at least 5" beyond the front of the cabinets. Cabinets installed above a cooktop must be no deeper than 13".

Be sure your appliance is properly installed and grounded by a qualified technician.

Make sure the cabinets and wall coverings around the range can withstand the temperatures (up to 200 °F) generated by the range.

### ANTI-TIP DEVICE

#### **⚠ WARNING**



#### **Tip-Over Hazard**

**A child or adult can tip the range and be killed. Verify the anti-tip bracket has been properly installed and engaged.**

**Ensure the anti-tip bracket is re-engaged when the range is moved.**

**Do not operate the range without the anti-tip bracket in place and engaged.**

**Failure to follow these instructions can result in death or serious burns to children or adults.**

# Installation Instructions

## PREPARE TO INSTALL THE RANGE

### TOOLS YOU WILL NEED

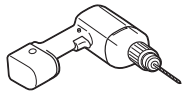

Drill with 1/8" Bit



Safety Glasses



Adjustable Wrench

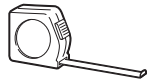

Tape Measure

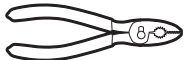

Pliers



Pencil



1/4" Nut Driver



Level



Phillips Screwdriver



Flat-blade Screwdriver

### PARTS INCLUDED

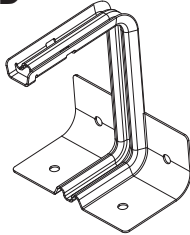

Anti-Tip Bracket Kit

### 1 REMOVE SHIPPING MATERIAL

Remove packaging materials. Failure to remove packaging materials could result in damage to the appliance.

### 2 PREPARE THE OPENING

- Allow 2" spacing from the range to adjacent vertical walls above the cooktop surface. Allow 30" minimum clearance between the surface units and the bottom of unprotected wood or metal top cabinet, and 18" minimum between the countertop and the adjacent cabinet bottom.
- To eliminate the risk of burns or fire when reaching over hot surface elements, cabinet storage space above the cooktop should be avoided. If cabinet storage space is to be provided above cooktop, the risk can be reduced by installing a range hood that protrudes at least 5" beyond the front of the cabinets. Cabinets installed above a cooktop may be no deeper than 13".

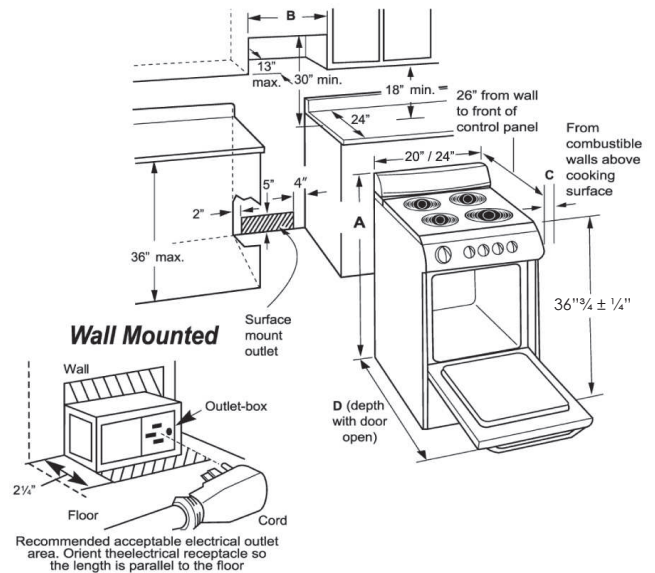

Model	A	B	C	D
20" Width	41 3/4"	19 3/4" min	2"	44 3/8"
24" Width	41 3/4"	23 3/4" min	2"	44 3/8"

#### Flooring under the range

Your range, like many other household items, is heavy and can settle into soft floor coverings such as cushioned vinyl or carpeting.

When moving the range on this type of flooring, it should be installed on a 1/4" thick sheet of plywood (or similar material) as follows:

When the floor covering ends at the front of the range, the area that the range will rest on should be built up with plywood to the same level or higher than the floor covering. This will allow the range to be moved for cleaning or servicing.

# Installation Instructions

## ELECTRICAL CONNECTIONS

### ELECTRICAL REQUIREMENTS

**⚠ CAUTION:** For personal safety, do not use an extension cord with this appliance. Remove house fuse or open circuit breaker before beginning installation.

This appliance must be supplied with the proper voltage and frequency, and connected to an individual properly grounded branch circuit, protected by a circuit breaker or fuse having an amperage as specified on the rating plate. The rating plate is located under the cooktop, underneath control panel or in the front frame. (See below pictures).

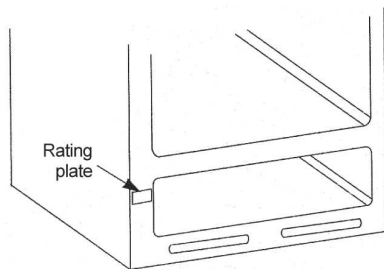

We recommend you have the electrical wiring and hookup of your range connected by a qualified electrician. After installation, have the electrician show you where your main range disconnect is located.

Check with your local utilities for electrical codes which apply in your area. Failure to wire your oven according to governing codes could result in a hazardous condition. If there are no local codes, your range must be wired and fused to meet the requirements of the Canadian Electrical Code, Part 1 Latest Edition.

### ELECTRICAL REQUIREMENTS

**⚠ WARNING:** For personal safety, do not use an extension cord with this appliance. Remove house fuse or open circuit breaker before beginning installation.

This appliance must be supplied with the proper voltage and frequency, and connected to an individual properly grounded branch circuit, protected by a circuit breaker or fuse having amperage as specified on the rating plate. The rating plate is located above the storage drawer on the oven frame.

We recommend you have the electrical wiring and hookup of your range connected by a qualified electrician. After installation, have the electrician show you where your main range disconnect is located.

Check with your local utilities for electrical codes which apply in your area. Failure to wire your oven according to governing codes could result in a hazardous condition. If there are no local codes, your range must be wired and fused to meet the requirements of the National Electrical Code, ANSI/NFPA No. 70- Latest Edition. You can get a copy by writing:

National Fire Protection Association  
Batterymarch Park  
Quincy, MA 02269

**Effective January 1, 1996, the National Electrical Code requires that new construction (not existing) utilize a 4-conductor connection to an electric range.**

**When installing an electric range in new construction, follow Steps 3 and 5 for 4-wire connection.**

You must use a 3-wire, single-phase A.C. 208Y/120 Volt or 240/120 Volt, 60 hertz electrical system. If you connect to aluminum wiring, properly installed connectors approved for use with aluminum wiring must be used.

If the electrical service provided does not meet the above specifications, have a licensed electrician install an approved outlet.

**NOTE:** Use of automatic, wireless, or wired external switches that shut off power to the appliance, are not recommended for this product.

# Installation Instructions

## ELECTRICAL CONNECTIONS

Use only a 3-conductor or a 4-conductor UL-listed range cord. These cords may be provided with ring terminals on wire and a strain relief device.

A range cord rated at 40 amps with 125/250 minimum volt range is required. A 50 amp range cord is not recommended but if used, it should be marked for use with nominal 13/8" diameter connection openings. Care should be taken to center the cable and strain relief within the knockout hole to keep the edge from damaging the cable.

- Because range terminals are not accessible after range is in position, flexible service conduit or cord must be used.

**NOTE:** If conduit is being used, go to Step 3D and then to Step 6 or 7.

- On some models, a filter capacitor may be connected between the black and white leads on the junction block.



ALL NEW BRANCH CIRCUIT INSTALLATIONS, MOBILE HOMES, RECREATIONAL VEHICLES AND INSTALLATIONS WHERE LOCAL CODES DO NOT ALLOW GROUNDING THROUGH NEUTRAL, REQUIRE A 4-CONDUCTOR CORD OR CONDUIT.

### 3 POWER CORD AND STRAIN RELIEF INSTALLATION

- A** Remove the wire cover (on the back of the range) by removing two (2) screws using a Phillips screw driver.

**Do not discard these screws.**

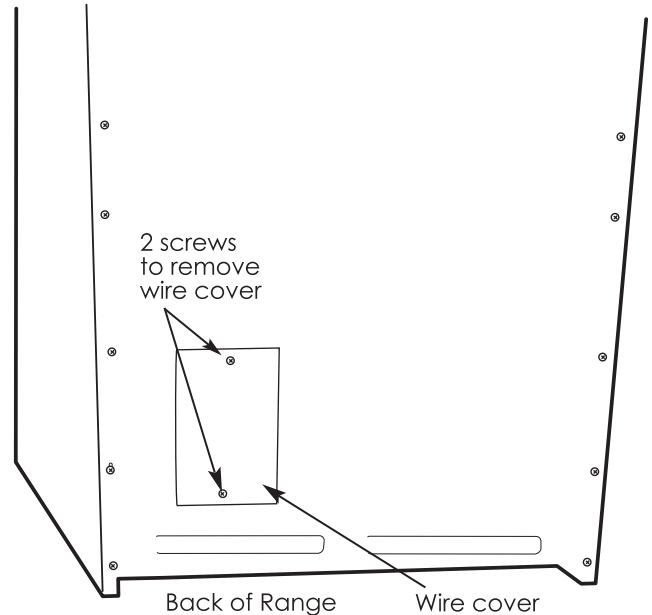

- B** Remove the knockout ring (1 1/8" or 1 3/8" depending on your model) located on bracket directly below the terminal block. To remove the knockout, use a pair of pliers to bend the knock-out ring away from the bracket and twist until ring is removed.

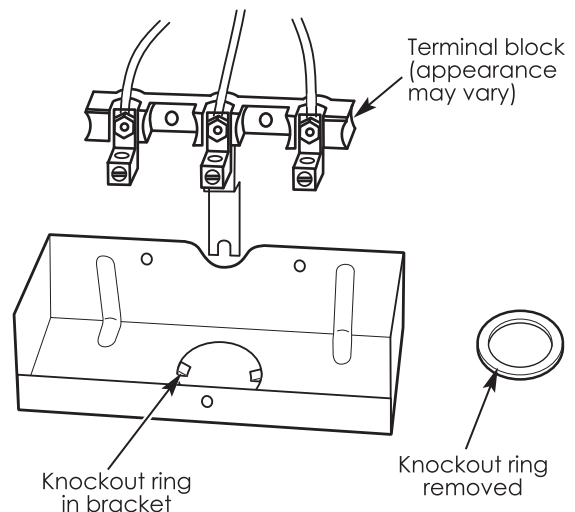

# Installation Instructions

## ELECTRICAL CONNECTIONS (CONT.)

- C** For power cord installations only (see the next step if using conduit), assemble the strain relief in the hole. Insert the power cord through the strain relief and tighten. Allow enough slack to easily attach the cord terminals to the terminal block. If tabs are present at the end of the winged strain relief, they can be removed for better fit.

**NOTE:** Do not install the power cord without a strain relief. The strain relief bracket should be installed before reinstalling the rear range wiring cover.

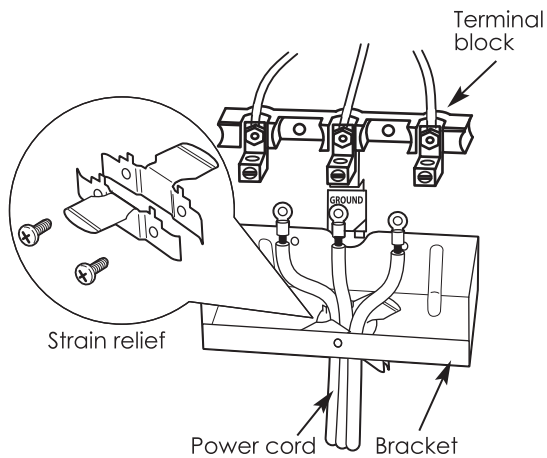

Skip to Step 4 or 5.

- D** For conduit installations only, purchase a squeeze connector matching the diameter of your conduit and assemble it in the hole. Insert the conduit through the squeeze connector and tighten. Allow enough slack to easily attach the wires to the terminal block.

**NOTE:** Do not install the conduit without a squeeze connector. The squeeze connector should be installed before reinstalling the rear range wiring cover.

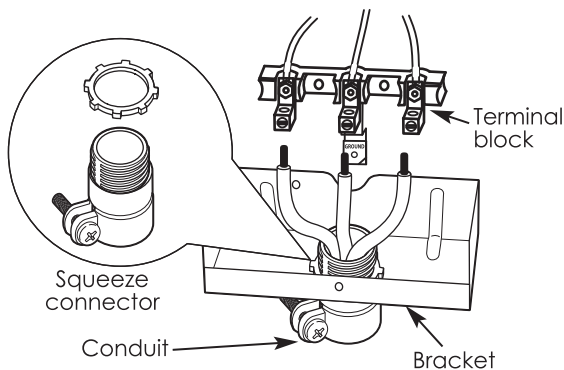

Skip to Step 6 or 7.

### 4 3-WIRE POWER CORD INSTALLATION

- ⚠ WARNING:** The neutral or ground wire of the power cord must be connected to the neutral terminal located in the center of the terminal block. The power leads must be connected to the left and the right terminals of the terminal block.

- A** Remove the 3 lower terminal screws from the terminal block. Insert the 3 power cord terminal rings into each one of the terminals of the terminal block. Be certain that the center wire (white/neutral) is connected to the center of the terminal block. Tighten nuts securely into the terminal block.

**DO NOT** remove the ground strap connection.

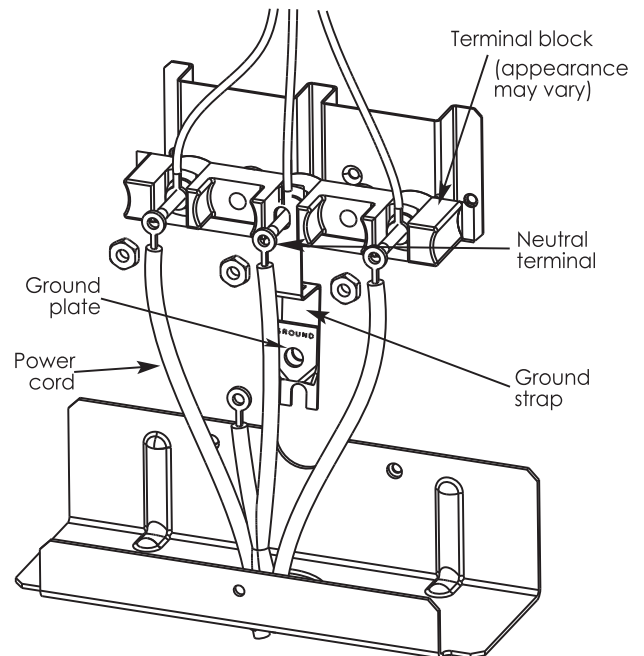

- B** Skip to Step 8 and proceed with the installation.

# Installation Instructions

## ELECTRICAL CONNECTIONS (CONT.)

### 5 4-WIRE POWER CORD INSTALLATION

**⚠ WARNING:** The neutral wire of the supply circuit must be connected to the neutral terminal located in the center of the terminal block. The power leads must be connected to the left and the right terminals of the terminal block. The 4th grounding lead must be connected to the frame of the range with the ground plate and the ground screw.

**A** Remove the 3 lower terminal nuts from the terminal block. Remove the ground screw and ground plate and retain them.

**B** **Cut and discard the ground strap. DO NOT DISCARD ANY SCREWS.**

**C** Insert the one ground screw into the power cord ground wire terminal ring, through the ground plate and into the frame of the range.

**D** Insert the 3 terminal screws (removed earlier) through each power cord terminal ring and into the lower terminals of the terminal block. Be certain that the center wire (white/neutral) is connected to the center lower position of the terminal block. Tighten screws securely into the terminal block.

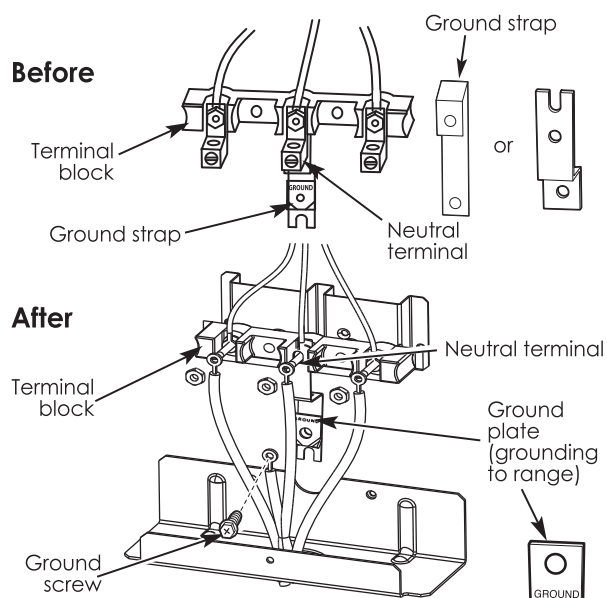

**E** Skip to Step 8 and proceed with the installation.

### 6 3-WIRE CONDUIT INSTALLATION

**A** Loosen the 3 lower terminal screws from the terminal block. Insert the center bare wire (white/neutral) tip through the bottom center terminal block opening. On certain models, the wire will need to be inserted through the ground strap opening and then into the bottom center block opening. Insert the two side bare wire tips into the lower left and the lower right terminal block openings. Tighten the screws until the wire is firmly secure (approximately 20 inch-lbs.).

#### **NOTE: ALUMINUM WIRING:**

Aluminum building wire may be used but it must be rated for the correct amperage and voltage to make connection. Connect wires according to this Step 6 or Step 7 depending on number of wires.

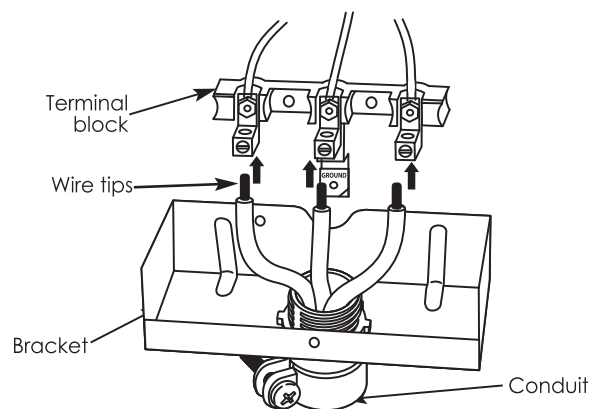

**Wire used, location and enclosure of splices, etc., must conform to good wiring practices and local codes.**

**B** Skip to Step 8 and proceed with the installation.

# Installation Instructions

## ELECTRICAL CONNECTIONS (CONT.)

### 7 4-WIRE CONDUIT INSTALLATION

**A** Loosen the three lower terminal screws from the terminal block. Remove the ground screw and ground plate and retain them.

**Cut and discard the ground strap.**

**DO NOT DISCARD ANY SCREWS.**

**B** Insert the ground bare wire tip between the range frame and the ground plate (removed earlier) and secure it in place with the ground screw (removed earlier). Insert the bare wire (white/neutral) tip through the bottom center of the terminal block opening. Insert the two side bare wire tips into the lower left and the lower right terminal block openings. Tighten the screws until the wire is firmly secure (approximately 20 inch-lbs.).

**Wire used, location and enclosure of splices, etc., must conform to good wiring practices and local codes.**

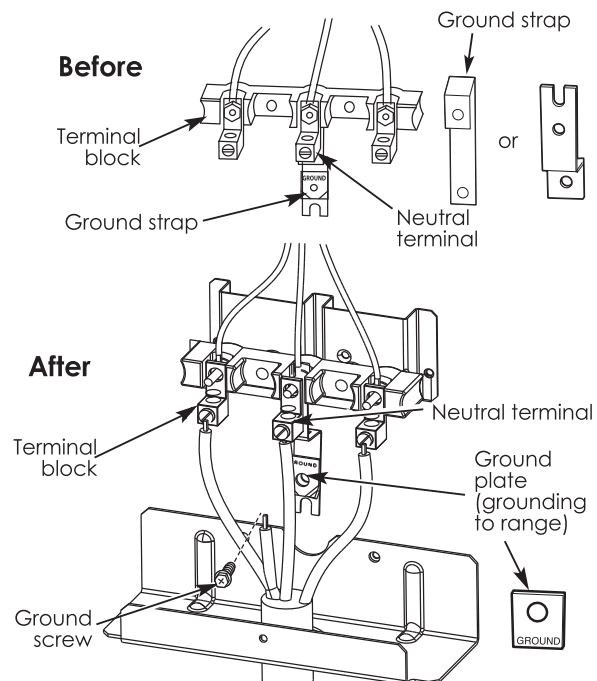

**C** Proceed to Step 8.

### 8 REPLACE THE WIRE COVER

Replace the wire cover on the range back by sliding its two lower retaining tabs into the slots and replacing the screw removed earlier. Make sure that no wires are pinched between the cover and the range back.

### 9 ANTI-TIP DEVICE INSTALLATION

#### ⚠ WARNING



#### Tip-Over Hazard

**A child or adult can tip the range and be killed. Verify the anti-tip bracket has been properly installed and engaged.**

**Ensure the anti-tip bracket is re-engaged when the range is moved.**

**Do not operate the range without the anti-tip bracket in place and engaged.**

**Failure to follow these instructions can result in death or serious burns to children or adults.**

To reduce the risk of tipping the range, the range must be secured by a properly installed anti-tip bracket. See installation instructions shipped with the bracket for complete details before attempting to install.

To check if the bracket is installed and engaged properly, look underneath the range to see that the anti-tip arm attached to the side panel is engaged in the bracket. On some models, the storage drawer or kick panel can be removed for easier inspection. If visual inspection is not possible, slide the range forward, confirm the anti-tip bracket is securely attached to the floor or wall, and slide the range back so the anti-tip arm slides just under the anti-tip bracket. If the range is pulled from the wall for any reason, always repeat this procedure to verify the range is properly secured by the anti-tip bracket.

# Installation Instructions

## INSTALL THE RANGE

### 10 REMOVE STORAGE DRAWER

- A** Pull the drawer out all the way.  
Lift the front of the drawer until the stops clear the guide.  
Remove the drawer.
- B** Lift the front of the drawer until the stops clear the guide.

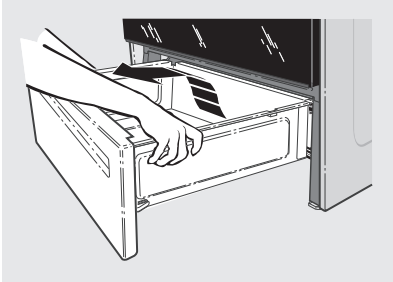

- C** Remove the drawer.

### 11 LEVEL THE RANGE

- A** Install the oven racks in the oven and position the range where it is to be installed.
- B** Check for levelness by placing a spirit level or a cup, partially filled with water, on one of the oven racks. If using a spirit level, take two readings - with the level placed diagonally first in one direction and then the other.

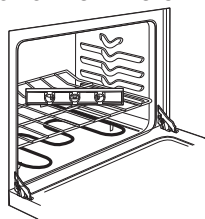

- C** The front leveling legs can be adjusted from the bottom and the rear legs can be adjusted from the top or the bottom.

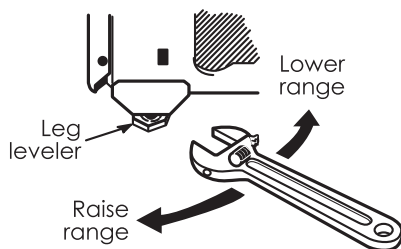

- D** Use an open-end or adjustable wrench to adjust the leveling legs until the range is level.

### 11 FINAL INSTALLATION CHECKLIST

- Check to make sure the circuit breaker is closed (RESET) or the circuit fuses are replaced.
- Be sure power is in service to the building.
- Note (on some models): If the clock flashes "bad" and then "LinE" with a loud tone, the neutral connection to the range is miswired. Check the terminal block connections and/or house wiring to correct.
- Check to be sure that all packing materials and tape have been removed. This will include tape on metal panel under control knobs (if applicable), adhesive tape, wire ties, cardboard and protective plastic. Failure to remove these materials could result in damage to the appliance once the appliance has been turned on and surfaces have heated.
- Check to make sure that the rear leveling leg is fully inserted into the Anti-Tip bracket and that the bracket is securely installed.

### 12 OPERATION CHECKLIST

- Turn on one of the surface units to observe that the element glows within 60 seconds. Turn the unit off when glow is detected. If the glow is not detected within the time limit, recheck the range wiring connections. If change is required, retest again. If no change is required, have building wiring checked for proper connections and voltage.
- Check to make sure the Clock (on models so equipped) display is energized. If a series of horizontal red lines appears in the display, disconnect power immediately. Recheck the range wiring connections. IF change is made to connections, retest again. If no change is required, have building wiring checked for proper connections and voltage. It is recommended that the clock be changed if the red lines appear.
- Be sure all range controls are in the OFF position before leaving the range.

# Before you call for service...



## Troubleshooting Tips

Save time and money! Review the charts on the following pages first and you may not need to call for service.



Safety Instructions

Operating Instructions

Care and Cleaning

Installation Instructions

Troubleshooting Tips

Consumer Support

Problem	Possible Causes	What To Do
<b>Radiant Cooktops</b>		
Surface units will not maintain a rolling boil or cooking is not fast enough.	Improper cookware being used.	<ul style="list-style-type: none"> <li>Use pans which are flat and match the diameter of the surface unit selected.</li> </ul>
Surface units do not work properly	A fuse in your home may be blown or the circuit breaker tripped.	<ul style="list-style-type: none"> <li>Replace the fuse or reset the circuit breaker.</li> </ul>
	Cooktop controls improperly set.	<ul style="list-style-type: none"> <li>Check to see the correct control is set for the surface unit you are using.</li> </ul>
Scratches (may appear as cracks) on cooktop glass surface	Incorrect cleaning methods being used.	<ul style="list-style-type: none"> <li>Scratches are not removable. Tiny scratches will become less visible in time as result of cleaning.</li> </ul>
	Cookware with rough bottoms being used or coarse particles (salt or sand) were between the cookware and the surface of the cooktop.	<ul style="list-style-type: none"> <li>To avoid scratches, use the recommended cleaning procedures. Make sure bottoms of cookware are clean before use, and use cookware with smooth bottoms.</li> </ul>
	Cookware has been slid across the cooktop surface.	
Areas of discoloration on the cooktop	Food spillovers not cleaned before next use.	<ul style="list-style-type: none"> <li>See the Cleaning the glass cooktop section.</li> </ul>
	Hot surface on a model with a light-colored glass cooktop.	<ul style="list-style-type: none"> <li>This is normal. The surface may appear discolored when it is hot. This is temporary and will disappear as the glass cools.</li> </ul>
Plastic melted to the surface	Hot cooktop came into contact with plastic placed on the hot cooktop.	<ul style="list-style-type: none"> <li>See the Glass surface - potential for permanent damage section in the Cleaning the glass cooktop section.</li> </ul>
Pitting (or indentation) of the cooktop	Hot sugar mixture spilled on the cooktop.	<ul style="list-style-type: none"> <li>Call a qualified technician for replacement.</li> </ul>
Frequent cycling off and on of surface units	Improper cookware being used.	<ul style="list-style-type: none"> <li>Use only flat cookware to minimize cycling.</li> </ul>
<b>Coil Cooktops</b>		
Surface units not functioning properly	The surface units are not plugged in solidly.	<ul style="list-style-type: none"> <li>With the controls off, check to make sure the surface unit is plugged completely into the receptacle.</li> </ul>
	The surface unit controls improperly set.	<ul style="list-style-type: none"> <li>Check to see the correct control is set for the surface unit you are using.</li> </ul>
	The drip pans are not set securely in the cooktop.	<ul style="list-style-type: none"> <li>With the controls off, check to make sure the drip pan is in the recess in the cooktop and that the opening in the pan lines up with the receptacle.</li> </ul>

# Before you call for service...

Problem	Possible Causes	What To Do
<b>Oven-All Models</b>		
Oven light does not work	Light bulb is loose or defective.	• Tighten or replace the bulb.
	Switch operating light is broken	• Call for service.
Oven will not work	Plug on range is not completely inserted in the electrical outlet.	• Make sure electrical plug is plugged into a live properly grounded outlet.
	A fuse in your home may be blown or the circuit breaker tripped.	• Replace fuse or reset circuit breaker.
	Oven controls improperly set.	• See the Using the oven section.
	On self-cleaning models door left in the locked position.	• If necessary, allow the oven to cool then unlock the door.
Food does not bake or roast properly	Oven controls improperly set.	• See the Using the oven section.
	Shelf positions are incorrect or the shelf is not level.	• See the Using the oven section.
	Incorrect cookware or cookware of improper size being used.	• See the Using the oven section.
	Oven thermostat needs adjustment.	• See the Adjust the oven thermostat-Easy to do yourself! Section.
No power supply from convenience outlet on top of backguard (on some models)	Small appliance plug is not completely inserted in the convenience outlet.	• Make sure the small appliance plug is properly inserted.
	The backguard is too hot and the convenience outlet breaker has tripped.	• Allow the range to cool, then reset the circuit breaker by pressing the switch located near the convenience outlet.

Safety Instructions

Operating Instructions

Care and Cleaning

Installation Instructions

Troubleshooting Tips

Consumer Support

# Before you call for service...

	Problem	Possible Causes	What To Do
Safety Instructions	Food does not broil properly	Oven is not set to BROIL.	<ul style="list-style-type: none"> <li>On models with a temperature knob, make sure you turn it all the way to the BROIL position. On models with a BROIL pad, make sure it is turned on.</li> </ul>
		Door not open to the broil stop position as recommended.	<ul style="list-style-type: none"> <li>See the Using the oven section.</li> </ul>
Operating Instructions	Food being cooked in a hot pan.	Improper shelf position being used.	<ul style="list-style-type: none"> <li>See the Broiling guide.</li> </ul>
		Food being cooked in a hot pan.	<ul style="list-style-type: none"> <li>Use the broiling pan and grid that came with your range. Make sure it is cool.</li> </ul>
		Cookware not suited for broiling.	<ul style="list-style-type: none"> <li>Use the broiling pan and grid that came with your range.</li> </ul>
Care and Cleaning	Aluminum foil used on the broiling pan and grid has not been fitted properly and slit as recommended.	Aluminum foil used on the broiling pan and grid has not been fitted properly and slit as recommended.	<ul style="list-style-type: none"> <li>See the Using the oven section.</li> </ul>
		In some areas the power (voltage) may be low.	<ul style="list-style-type: none"> <li>Preheat the broil element for 10 minutes.</li> <li>Broil for the longest period of time recommended in the Broiling guide.</li> </ul>
		Control signals after entering cooking time or delay start	<ul style="list-style-type: none"> <li>Press the BAKE pad and desired temperature or the CLEAN pad and desired clean time.</li> </ul>
Installation Instructions	Display flashes "bAd" then "linE" with a loud tone.	You forgot to enter a bake temperature or cleaning time.	<ul style="list-style-type: none"> <li>Contact installer or electrician to correct miswiring.</li> </ul>
		Oven temperature too hot or too cold	<ul style="list-style-type: none"> <li>The installed connection from the house to the unit is miswired.</li> </ul>
Troubleshooting Tips	Clock and timer do not work	Oven thermostat needs adjustment.	<ul style="list-style-type: none"> <li>See the Adjust the oven thermostat-Easy to do yourself! Section.</li> </ul>
		Plug on range is not completely inserted in the electrical outlet.	<ul style="list-style-type: none"> <li>Make sure electrical plug is plugged into a live, properly grounded outlet.</li> </ul>
		A fuse in your home may be blown or the circuit breaker tripped.	<ul style="list-style-type: none"> <li>Replace fuse or reset circuit breaker.</li> </ul>
Consumer Support	Display goes blank	Oven controls improperly set.	<ul style="list-style-type: none"> <li>See the Using the clock, timer and convenience outlet section.</li> </ul>
		A fuse in your home may be blown or the circuit breaker tripped.	<ul style="list-style-type: none"> <li>Replace fuse or reset circuit breaker.</li> </ul>
		The clock is turned off from showing in the display.	<ul style="list-style-type: none"> <li>See the Using the clock, timer and convenience outlet section.</li> </ul>



# Before you call for service...

Problem	Possible Causes	What To Do
Oven door is crooked	The door is out of position.	<ul style="list-style-type: none"> <li>Because the oven door is removable, it sometimes gets out of position during installation. To straighten the door, push down on the high corner.</li> </ul>
Oven makes clicking noise	This is the sound of the heating element turning off and on during cooking functions.	<ul style="list-style-type: none"> <li>This is normal.</li> </ul>
"F-and number or letter" flash in the display	<p>You have a function error code.</p> <hr/> <p>If the function code repeats:</p>	<ul style="list-style-type: none"> <li>Press the OFF pad. Put the oven back into operation.</li> <li>Disconnect all power to the range for at least 30 seconds and then reconnect power. If the function error code repeats, call for service.</li> <li>On self-cleaning models, if a function error code appears during the self-cleaning cycle, check the oven door latch. The latch may have been moved, if only slightly, from the locked position. Make sure the latch is moved to the right as far as it will go. Press the OFF pad. Allow the oven to cool for one hour. Put the oven back into operation.</li> </ul>
Power outage	Power outage or surge.	<ul style="list-style-type: none"> <li>Some models will automatically resume their setting once the power is restored. On models with a clock, you must reset the clock. If the oven was in use, you must reset it by pressing the OFF pad, setting the clock and resetting any cooking function.</li> </ul>
Display flashes	Power failure.	<ul style="list-style-type: none"> <li>Reset the clock.</li> </ul>
Unable to get the display to show "SF"	Oven control pads were not pressed properly.	<ul style="list-style-type: none"> <li>The BAKE and BROIL pads must be pressed at the same time and held for 3 seconds.</li> </ul>
"Burning" or "oily" odor emitting from the oven vent.	This is normal in a new oven and will disappear in time.	<ul style="list-style-type: none"> <li>To speed the process set a self-clean cycle for a minimum of 3 hours. See the Using the self-cleaning oven section.</li> </ul>
Strong odor	An odor from the insulation around the inside of the oven is normal for the first few times the oven is used.	<ul style="list-style-type: none"> <li>This is temporary.</li> </ul>

Safety Instructions

Operating Instructions

Care and Cleaning

Installation Instructions

Troubleshooting Tips

Consumer Support

# Accessories

Safety Instructions

Operating Instructions

Care and Cleaning

Installation Instructions

Troubleshooting Tips

Consumer Support



## Looking For Something More?

To inquire about purchasing a part or an accessory for your appliance, contact the authorized service center.

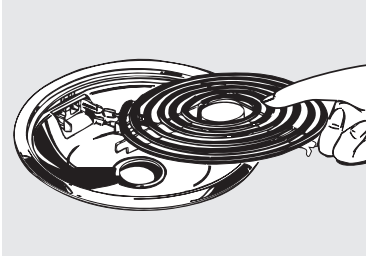

Surface Elements & Drip Pans

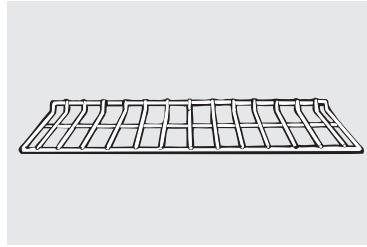

Oven Racks

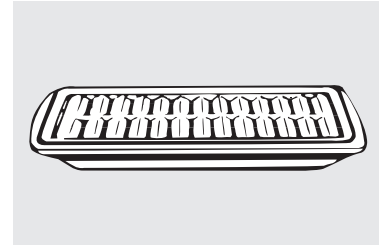

Broiler Pan

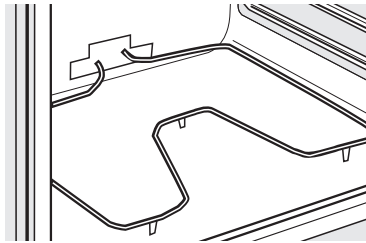

Oven Elements



Light Bulbs

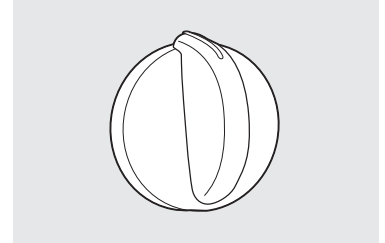

Knobs



Cleaner

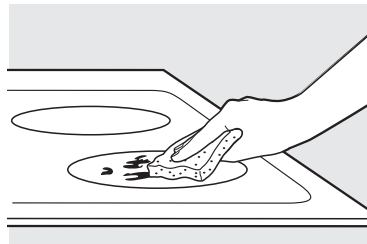

Cleaning Pads

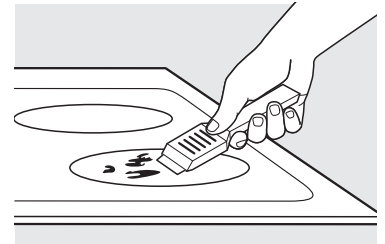

Scraper



FELIX STORCH, INC  
770 Garrison Avenue  
Bronx, NY 10474  
TEL 718-893-3900  
FAX 844-478-8799  
info@summitappliance.com  
www.summitappliance.com

## PARTS AND LABOR WARRANTY INFORMATION

SUMMIT Appliances are manufactured to provide outstanding value, and your satisfaction is our goal on every product. All SUMMIT major appliances carry a one year limited warranty on both parts and labor. All refrigerators and freezers carry an additional four years on the compressor. Certain exclusions may apply.

### GENERAL PARTS AND LABOR WARRANTY

Summit warrants, to the original purchaser of every new unit, that the cabinet and all parts thereof be free from defects in material or workmanship, under normal and proper use and maintenance service as specified by Summit and upon proper installation and start-up in accordance with the instruction packet supplied with each Summit unit. Summit's obligation under this warranty is limited to a period of 12 months from the date of original purchase.

Any parts, covered under this warranty, that are determined by Summit to have been defective, within the above said period, are limited to the repair or replacement, including labor charges, of defective parts or assemblies. The labor warranty shall include pre-approved standard straight time labor charges only and reasonable travel time, as determined by Summit.

### WARRANTY CLAIMS

All claims for labor or parts must be made directly through Summit. All claims should include: model number of the unit, the serial number of the cabinet, proof of purchase, date of installation, and all pertinent information supporting the existence of the alleged defect. All claims should be filed within 30 days of completed repair or the warranty claim could be refused.

### THINGS NOT COVERED BY THIS WARRANTY

Summit's sole obligation under this warranty is limited to either repair or replacement of parts, subject to the additional limitations below. This warranty neither assumes nor authorizes any person to assume obligations other than those expressly covered by this warranty.

- **NO CONSEQUENTIAL DAMAGES:** Summit is not responsible for economic loss; profit loss; or special, direct, indirect, or consequential damages, including without limitation, losses or damages arising from food or product spoilage claims whether or not on account of refrigeration failure.
- **WARRANTY IS NOT TRANSFERABLE:** This warranty is not assignable and applies only in favor of the original purchaser/user to whom delivered. Any such assignment or transfer shall void the warranties herein made and shall void all warranties, express or implied, including any warranty of merchantability or fitness for a particular purpose.
- **IMPROPER USE:** Summit assumes no liability for parts or labor coverage for component failure or other damages resulting from improper usage or installation or failure to clean and/or maintain product as set forth in the warranty packet provided with the unit.
- **ALTERATION, NEGLIGENCE, ABUSE, MISUSE, ACCIDENT, DAMAGE DURING TRANSIT OR INSTALLATION, FIRE, FLOOD, ACTS OF GOD:** Summit is not responsible for the repair or replacement of any parts that Summit determines have been subjected after the date of manufacture to alteration, neglect, abuse, misuse, accident, damage during transit or installation, fire, flood, or act of God.
- **IMPROPER ELECTRICAL CONNECTIONS:** Summit is not responsible for the repair or replacement of failed or damaged components resulting from electrical power failure, the use of extension cords, low voltage, or voltage drops to the unit.





FELIX STORCH, INC  
770 Garrison Avenue  
Bronx, NY 10474

TEL 718-893-3900  
FAX 844-478-8799

✉ info@summitappliance.com

www.summitappliance.com

- **NO IMPLIED WARRANTY OF MERCHANTABILITY OR FITNESS FOR A PARTICULAR PURPOSE:** There are no other warranties, expressed, implied or statutory, except the parts & labor warranty specifically described above. These warranties are exclusive and in lieu of all other warranties, including implied warranty and merchantability or fitness for a particular purpose. There are no other warranties which extend beyond the description on the face hereof.
- **OUTSIDE UNITED STATES:** This warranty does not apply to, and Summit is not responsible for, any warranty claims made on products sold or used outside the United States.

### REQUESTING SERVICE

If you are in need of service, please either fill out a service request on our website, <http://www.summitappliance.com/support>, or call us at 800-932-4267 or 718-893-3900. Please be prepared to give us the following information: your name, address, phone, email, model, serial, date of purchase, place of purchase, and the problem you are having.

### CALIFORNIA PROPOSITION 65

WARNING! This product may contain chemicals known to the state of California to cause cancer or birth defects or other reproductive harm. For more information, visit: [www.summitappliance.com/prop65](http://www.summitappliance.com/prop65)

Chemicals known by the manufacturer to be present in this product in concentrations higher than threshold limits: NONE.