



APPLIANCES FOR LIVING

 **ARTUSI**
THE ART OF LIVING

A0960
OPERATION MANUAL

Congratulations, you are now the proud owner of an ARTUSI cooking appliance. Thank you for purchasing ARTUSI and welcome to the ARTUSI Family.

This instruction manual has been specially created to inform you of the full range of features your ARTUSI appliance has to offer and serves as an introduction to getting the very best out of your ARTUSI appliance.

We present detailed information on each of the features your ARTUSI appliance consists of. Once you have read this section you will be able to choose the most appropriate settings for your appliance when cooking different types of food.

We ask you to read the instructions in this booklet very carefully as this will allow you to get the best results from using your appliance. KEEP THE DOCUMENTATION OF THIS PRODUCT FOR FUTURE REFERENCE.

TO REGISTER YOUR PRODUCT WITH ARTUSI, PLEASE FILL OUT THE WARRANTY CARD AT THE END OF THIS BOOKLET AND POST IT TO: **REPLY PAID 83617**
LEICHHARDT NSW 2040

IT

**CARO
CLIENTE,**

sentitamente La ringraziamo e ci congratuliamo per la scelta da Lei fatta.

Questo nuovo prodotto accuratamente progettato e costruito con materiali di primissima qualità, è stato accuratamente collaudato per poter soddisfare tutte le esigenze di una perfetta cottura. La preghiamo pertanto di leggere e rispettare le facili istruzioni che Le permetteranno di raggiungere eccellenti risultati fin dalla primissima utilizzazione.

IL COSTRUTTORE

GB

**DEAR
CUSTOMER,**

We thank you and congratulate you on your choice.

This new carefully designed product, manufactured with the highest quality materials, has been carefully tested to satisfy all your cooking demands.

We would therefore request you to read and follow these easy instructions which will allow you to obtain excellent results right from the start.

THE MANUFACTURER

FR

**CHÈRE CLIENTE,
CHER CLIENT,**

Merci et sincères félicitations pour le choix que vous avez fait.

Ce nouveau produit, conçu avec soin et fabriqué avec des matières de toute première qualité, a été soigneusement testé pour satisfaire toutes vos exigences d'une cuisson parfaite.

Nous vous prions de bien vouloir lire et suivre des simples instructions, que vous permettront d'atteindre d'excellents résultats dès la première utilisation.

LE CONSTRUCTEUR



IMPORTANTE

La targhetta delle caratteristiche del forno è accessibile anche ad apparecchio installato. In questa targhetta, visibile aprendo la porta, sono riportati tutti i dati di identificazione dell'apparecchio a cui si dovrà fare riferimento per richiesta di ricambi.

Durante il funzionamento l'apparecchio diventa molto caldo, fare attenzione a non toccare gli elementi riscaldanti all'interno del forno.

IMPORTANT

The oven's data plate is accessible even with the oven fully installed. The plate is visible simply by opening the door. Always quote the details from it to identify the appliance when ordering spare parts.

The appliance becomes very hot during use. Take great care not to touch the heating elements inside the oven.

WARNING: Accessible parts may become hot during use. Young children should be kept away.

IMPORTANT

Il est possible d'accéder à la plaque des caractéristiques du four même lorsque l'appareil est installé. Cette plaque, que l'on voit en ouvrant la porte, présente toutes les données d'identification de l'appareil qu'il est nécessaire de citer pour toute demande de pièces de rechange.

Pendant le fonctionnement, l'appareil devient très chaud : faire attention à ne pas toucher les éléments chauffants à l'intérieur du four.

IT**RISPETTO
DELL'AMBIENTE**

La documentazione del presente apparecchio utilizza carta sbiancata, senza cloro, oppure carta riciclata allo scopo di contribuire alla protezione dell'ambiente

Gli imballaggi sono concepiti per non danneggiare l'ambiente; possono essere recuperati o riciclati essendo prodotti ecologici.

Riciclando l'imballaggio, si contribuirà ad un risparmio di materie prime e ad una riduzione del volume degli scarti industriali e domestici.

GB**RESPECT FOR THE
ENVIRONMENT**

The documentation provided with this oven has been printed on chlorine free bleached paper or recycled paper to show respect for the environment.

The packaging has also been designed to avoid environmental impact. Packaging material is ecological and can be re-used or recycled.

By recycling the packaging, you will help save raw materials as well as reducing the bulk of domestic and industrial waste.

FR**RESPECT DE
L'ENVIRONNEMENT**

La documentation de cet appareil est imprimée sur du papier blanchi, sans chlore ou sur du papier recyclé, de façon à contribuer à la sauvegarde de l'environnement.

Les emballages sont conçus pour ne pas nuire à l'environnement; ils peuvent être récupérés ou recyclés, car il s'agit de produits écologiques.

Le fait de recycler l'emballage permet de consommer moins de matières premières et de réduire le volume des déchets industriels et domestiques.

WARNINGS

THIS APPLIANCE IS CONCEIVED FOR DOMESTIC USE ONLY. THE MANUFACTURER SHALL NOT IN ANY WAY BE HELD RESPONSIBLE FOR WHATEVER INJURIES OR DAMAGES ARE CAUSED BY INCORRECT INSTALLATION OR BY UNSUITABLE, WRONG OR ABSURD USE.

DO NOT PLACE TIN FOIL, PANS OR SIMILAR IN CONTACT WITH THE INNER BASE OF THE OVEN TO COOK. THE HEATING ACTION OF THE LOWER RESISTANCE CAUSES THE LOWER PART OF THE OVEN TO OVERHEAT, LEADING TO DAMAGE AND EVEN SERIOUS CONSEQUENCES (FIRE RISK) ALSO TO THE UNIT IN WHICH THE OVEN IS INSTALLED.

DO NOT USE HARSH ABRASIVE CLEANERS OR SHARP METAL SCRAPERS TO CLEAN THE OVEN DOOR GLASS SINCE THEY CAN SCRATCH THE SURFACE, WHICH MAY RESULT IN SHATTERING OF THE GLASS.

This appliance is not intended for use by persons (including children) with reduced physical, sensory or mental capabilities, or lack of experience and knowledge, unless they have been given supervision or instruction concerning use of the appliance by a person responsible for their safety.

CHILDREN SHOULD BE SUPERVISED TO ENSURE THAT THEY DO NOT PLAY WITH THE APPLIANCE.

DO NOT PLACE TIN FOIL, PANS OR SIMILAR IN CONTACT WITH THE INNER BASE OF THE OVEN TO COOK. THE HEATING ACTION OF THE LOWER RESISTANCE CAUSES THE LOWER PART OF THE OVEN TO OVERHEAT, LEADING TO DAMAGE AND EVEN SERIOUS CONSEQUENCES (FIRE RISK) ALSO TO THE UNIT IN WHICH THE OVEN IS INSTALLED.

- KEEP CHILDREN AWAY, UNLESS CONSTANTLY SUPERVISED.

- CHILDREN MAY NOT PERFORM CLEANING AND MAINTENANCE UNSUPERVISED.

- DO NOT USE HARSH ABRASIVE CLEANERS OR SHARP METAL SCRAPERS TO CLEAN THE

OVEN DOOR GLASS SINCE THEY CAN SCRATCH THE SURFACE, WHICH MAY RESULT IN SHATTERING OF THE GLASS.

Only use the temperature probe recommended for this oven.

The oven must not be installed behind a decorative door in order to avoid overheating.

IT

GB

FR

PRIMO UTILIZZO THE FIRST TIME PREMIERE YOU USE THE OVEN UTILISATION

Il forno va pulito a fondo con acqua e sapone e risciacquato accuratamente. Per togliere i telai laterali nei forni con pareti lisce procedere come illustrato in figura.

Riscaldare il forno per circa 30 minuti alla massima temperatura; verranno così eliminati tutti i residui grassi di lavorazione che potrebbero causare sgradevoli odori in fase di cottura.

Clean the oven thoroughly with soapy water and rinse well. To remove the lateral frames from smooth-walled ovens, proceed as shown in the figure.

Operate the oven for about 30 minutes at maximum temperature to burn off all traces of grease which might otherwise create unpleasant smells when cooking.

Le four doit être nettoyé à fond à l'eau et au savon, puis rincé méticuleusement. Pour enlever les cadres latéraux dans les fours à parois lisses, procéder comme indiqué sur la figure.

Il convient de n'insérer la nourriture que lorsque le four a atteint la température préétablie, c'est-à-dire quand s'éteint le voyant lumineux.

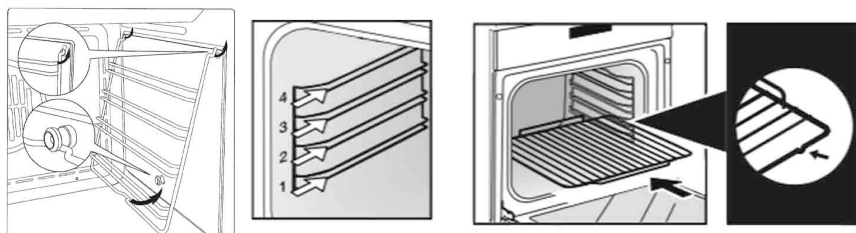

Importante:

come precauzione di sicurezza prima di procedere a qualsiasi operazione di pulizia del forno staccare sempre la spina della presa di corrente o togliere la linea di alimentazione dell'apparecchio. Inoltre evitare di usare sostanze acide o alcaline (succhi di limone, aceto, sale, pomodori ecc.). Evitare di usare prodotti a base di cloro, acidi o abrasivi specialmente per la pulizia delle pareti verniciate.

Important:

As a safety precaution, before cleaning the oven, always disconnect the plug from the power socket or the power cable from the oven. Do not use acid or alkaline substances to clean the oven (lemon juice, vinegar, salt, tomatoes etc.). Do not use chlorine based products, acids or abrasive products to clean the painted surfaces of the oven.

Important:

A titre de précaution, avant d'effectuer toute opération de nettoyage du four quelle qu'elle soit, débrancher toujours la fiche de la prise de courant ou couper la ligne d'alimentation de l'appareil. Veiller à ne pas utiliser de substances acides ou alcalines (jus de citron, vinaigre, sel, tomate, etc.). Ne pas utiliser de produits à base de chlore, acides ou abrasifs, surtout pour le nettoyage des parois peintes.

**NON UTILIZZARE
PULITORIA VAPORE PER
LA PULIZIA DEL FORNO.**

**DO NOT USE STEAM
CLEANERS TO CLEAN
THE OVEN.**

**NE PAS UTILISER DE
NETTOYEURS VAPEUR
POUR NETTOYER LE FOUR.**

IT**PANNELLI
AUTOPULENTI
CATALICI**

I nostri forni con pareti lisce hanno la possibilità di montare all'interno della muffola dei pannelli autopulenti che ricoprono le pareti.

Questi speciali pannelli, da agganciare alle pareti prima dei telai laterali, sono ricoperti di uno speciale smalto catalitico microporoso che ossida e vaporizza gradualmente gli schizzi di olio e grasso eliminandoli durante le cotture sopra i 200° C.

Se dopo una cottura di cibi molto grassi il forno non è pulito, farlo funzionare a vuoto alla massima temperatura per un tempo massimo di 60 minuti.

I pannelli autopulenti non devono essere lavati né puliti con prodotti abrasivi o prodotti contenenti acidi o alcali.

GB**SELF-CLEANING
CATALYTIC
PANELS**

Our smooth walled ovens can be fitted with self-cleaning panels to cover the inside walls.

These special panels are simply hooked on to the walls before the side frames are fitted. They are coated in a special, micro-porous catalytic enamel which oxidises and gradually vaporises splashes of grease and oil at cooking temperatures above 200° C.

If the oven is not clean after cooking fatty foods, operate the empty oven for 60 minutes (max.) at maximum temperature.

Never wash or clean self-cleaning panels with abrasive, acid, or alkaline products.

FR**PANNEAUX
AUTONETTOYANTS
CATALYTIQUES**

Nos fours à parois lisses peuvent être munis, à l'intérieur, de panneaux autonettoyants qui recouvrent les parois.

Devant être accrochés sur les parois, avant les châssis latéraux, ces panneaux spéciaux sont recouverts d'un émail spécial catalytique microporeux qui provoque l'oxydation et l'évaporation graduelles des éclaboussures d'huile et de graisse qui sont ainsi éliminées pendant les cuissons à plus de 200° C.

Si le four n'est pas propre après la cuisson d'aliments très gras, le faire fonctionner à vide à la température maximum pendant 60 minutes maximum.

Les panneaux autonettoyants ne doivent être ni lavés, ni nettoyés avec des produits abrasifs ou des produits contenant des acides ou des alcalis.

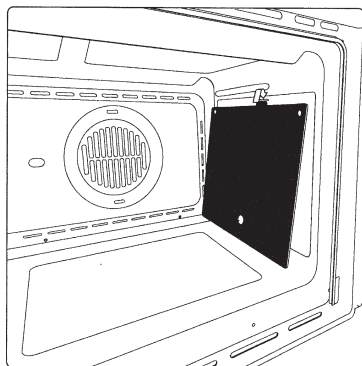

TIMER TOUCH CONTROL



Setting the clock



Figure 1

“Auto” and “0:00” will start flashing when the unit is switched on for the first time. To set the clock, press the central button for about 3 seconds. When  appears, press “+” or “-” to set the correct time.

Wait until a beep tells you that the clock has been set (figure 1).

To set the time at a later stage, press “+” and “-” together for 3 seconds and then adjust the clock as described above.

Minute counter



Figure 2

As this minute counter does not control the oven, when it finishes counting the oven will continue to work.

To set, press the central button for 3 seconds until  appears (figure 2). Press “+” and “-” to set the required time.

To set the minute counter at a later stage, press the central button for 3 seconds and adjust as described above.

The minute counter beeps when it finishes counting. To disable it, press any button.

Cooking time



Figure 3

This is a semi-automatic cooking function. It can be used to set cooking times.

Press the central button for 3 seconds. Then press it again until “dur” appears (figure 3). Press “+” and “-” to set the required cooking time.

End of cooking time



Figure 4

The end of cooking time can also be set.

Press the central button for 3 seconds. Press the central button twice consecutively and wait for “End” to appear (figure 4). Press “+” and “-” to set the required end of cooking time.

The oven will work in the set mode and at the set temperature until the end of cooking time.

Programming automatic cooking



Figure 5

Cooking function with set times.

Press the central button for 3 seconds. Then press it again until “dur” appears. Press “+” and “-” to set the required cooking time. Wait a few seconds for the setting to be memorised.

Press the central button for 3 seconds. Press it another two times and wait for “End” to appear (figure 4). Press “+” and “-” to set the required end of cooking time.

E.g.:

Current time: 12.30

Cooking time: 10 minutes

End of cooking time: 14.00

The oven will start cooking at 13.50 (14.00 less 00.10) at the set temperature and in the set mode and will stop at 14.00

The oven will beep when it stops cooking. To disable it, press any button.

Adjusting beep volume



To adjust beep volume, press “+” and “-” together. Then press the central button and wait for “ton1” (high volume) to flash. Press “-” to select “ton2” (medium volume) or “ton3” (low volume).

Press the central button to set the selected volume.

IT

GB

FR

FUNZIONI PANNELLO COMANDI

CONTROL PANEL FUNCTIONS

FONCTIONS DU PANNEAU DE COMMANDE

SIMBOLI FUNZIONI SUL
COMMUTATORE

FUNCTION SYMBOLS
ON THE SELECTOR

SYMBOLS DES
FONCTIONS SUR LE
COMMUTATEUR



Lampada forno (rimane
sempre accesa durante il
funzionamento).

Oven light (stays on while
oven is in use).

Lampe du four (reste al-
lumée pendant la marche).



Resistenza inferiore. Rego-
lazione del termostato da
50° C a MAX.

Bottom heating element.
Thermostat setting from
50°C to MAX.

Résistance inférieure.
Régulation du thermostat de
50° C à MAX.



Resistenza superiore ed in-
feriore. Regolazione del ter-
mostato da 50° C a MAX.

Top and bottom heating
elements. Thermostat
setting from 50°C to MAX.

Résistance inférieure et su-
périeure. Réglage du ther-
mostat de 50° C à MAX.



Resistenza superiore, infe-
riore con ventilatore. Rego-
lazione del termostato da
50° C a MAX.

Top and bottom heating
elements with fan. Thermo-
stat setting from 50°C to
MAX.

Résistance supérieure, infé-
rieure avec ventilateur. Ré-
glage du thermostat de
50°C à MAX.



Resistenza circolare con
ventilatore. Regolazione del
termostato da 50° C a MAX.

Circular heating element
with fan. Thermostat setting
from 50°C to MAX.

Résistance circulaire avec
ventilateur. Réglage du
thermostat de 50° C à
MAX.



Ventilatore per sconge-
lamento. Regolazione del ter-
mostato a 0° C.

Fan for defrosting. Thermo-
stat setting at 0°C.

Ventilateur pour décongé-
lation. Réglage du thermo-
stat à 0° C.



Resistenza inferiore con
ventilatore. Regolazione del
termostato da 50° C a MAX.

Bottom heating element
with fan. Thermostat
setting from 50°C to MAX.

Résistance inférieure avec
ventilateur. Réglage du
thermostat de 50°C à MAX.



Doppia resistenza superiore
con ventilatore (grill grande
superficie). Regolazione del
termostato da 50° a 200° C.

Double top heating element
with fan (large area grill).
Thermostat setting from
50°C to 200°C.

Double résistance supé-
rieure avec ventilateur (grill
à grande surface). Réglage
du thermostat de 50° à
200°C.



Doppia resistenza superiore
(grill grande superficie). Rego-
lazione del termostato da
50° a 200° C.

Double top heating element
(large area grill). Thermo-
stat setting from 50°C to
200°C.

Double résistance supé-
rieure (grill à grande sur-
face). Réglage du thermo-
stat de 50° à 200°C.

IT**GB****FR**

Resistenza superiore (grill superficie e potenza ridotta). Regolazione del termostato da 50° a 200° C.

Top heating element (small, low power grill). Thermostat setting from 50°C to 200°C.

Résistance supérieure (grill à grande surface et puissance réduite). Réglage du thermostat de 50° à 200°C.



Resistenza inferiore + Resistenza circolare con ventilatore. Regolazione del termostato da 50° C a MAX.

Bottom heating element + Circular heating element with fan. Thermostat setting from 50°C to MAX.

Résistance inférieure + Résistance circulaire avec ventilateur. Réglage du thermostat de 50° C à MAX.

ISTRUZIONI DI FUNZIONAMENTO

INSTRUCTIONS FOR USE

INSTRUCTIONS POUR LE FONCTIONNEMENT

COTTURA CONVENZIONALE



Sistema classico che utilizza calore superiore ed inferiore adatto per la cottura di un solo piatto.

E' bene che il cibo venga inserito quando il forno ha raggiunto la temperatura prestabilita, cioè quando si e' spenta la spia luminosa.

Se verso fine cottura si avesse necessità di incrementare la temperatura inferiore o superiore, posizionare il commutatore nella rispettiva posizione. Si consiglia di aprire il meno possibile la porta del forno durante la cottura.

CONVENTIONAL COOKING



Conventional cooking uses top and bottom heat to cook a single dish.

Place the food in the oven only once cooking temperature has been reached, i.e. when the heating indicator goes out.

If you want to increase top or bottom temperature towards the end of the cooking cycle, set the temperature control to the right position. It is advisable to open the oven door as little as possible during cooking.

CUISSON CONVENTIONNELLE



Système classique utilisant la chaleur supérieure et inférieure, indiqué pour la cuisson d'un seul plat.

Il convient de n'insérer la nourriture que lorsque le four a atteint la température préétablie, c'est-à-dire quand s'éteint le voyant lumineux.

Si, vers la fin de la cuisson, il est nécessaire d'augmenter la température inférieure ou supérieure, il faut placer le commutateur dans la position adéquate. On conseille d'ouvrir le moins possible la porte du four au cours de la cuisson.

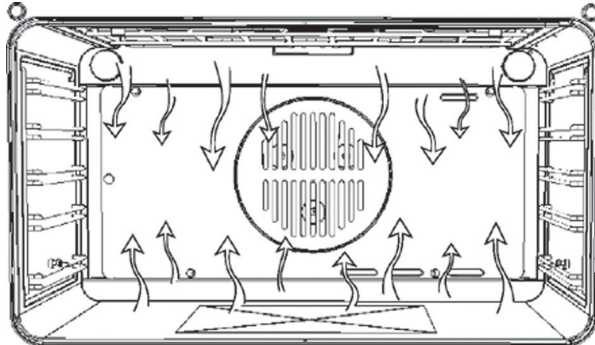

IT

GB

FR

**COTTURA
VENTILATO**

Con questo tipo di cottura, un ventilatore posto nella parte posteriore fa circolare l'aria calda all'interno del forno, distribuendola in modo uniforme. La cottura avviene più rapidamente rispetto alla cottura convenzionale. Il sistema risulta idoneo per la cottura su più ripiani ed anche per cibi di natura diversa (pesce, carne ecc.).

**FAN
COOKING**

For this type of cooking a fan positioned at the back allows the circulation of hot air inside the oven, creating uniform heat. In this way cooking is more rapid than conventional cooking. It is a suitable method for cooking dishes on more than one shelf, especially when the food is of different types (fish, meat etc.)

**CUISSON
VENTILEE**

Avec ce type de cuisson, un ventilateur placé dans la partie postérieure fait circuler l'air chaud à l'intérieur du four, en le répartissant uniformément. La cuisson se fait plus rapidement que par rapport à la cuisson conventionnelle. Le système se prête bien à la cuisson sur plusieurs étages et également d'aliments de différents types (poisson, viande, etc.)

SCONGELAMENTO

Selezionando una delle funzioni di cottura ventilato e regolando il termostato sullo zero, il ventilatore farà circolare all'interno del forno aria fredda, favorendo così un rapido scongelamento dei cibi congelati.

DEFROSTING

By selecting one of the fan cooking functions and setting the thermostat to zero, the fan allows cold air to circulate inside the oven. In this way frozen food can be rapidly defrosted.

DECONGELATION

En sélectionnant une des fonctions de cuisson ventilée et en réglant le thermostat sur zéro, le ventilateur fera circuler de l'air froid à l'intérieur du four, en provoquant de cette manière une décongélation rapide des aliments congelés.

Non e' necessario il preriscaldamento, ma per pasticceria e' preferibile farlo.

It is not essential to pre-heat the oven, but you are advised to do so when cooking pastries.

Le préchauffage n'est pas nécessaire; il est toutefois préférable d'y recourir pour la pâtisserie.

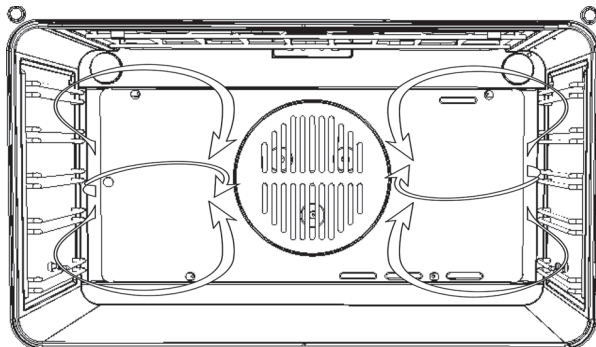

IT**GB****FR****COTTURA AL GRILL****GRILL COOKING****CUISSON AU GRIL**

Tipo di cottura per la grigliatura o doratura dei cibi. Alcuni forni possono essere completi di motorino asta e spiedo per cottura al girarrostro.

La griglia con il cibo da cuocere va inserito nella 1° o 2° posizione da sopra.

Preriscaldare per 5'. Ruotare la manopola del termostato con temperature da 50° a 200°.



Use the grill to grill or brown foods.

Some ovens may be equipped with an electric motor, spit and skewers for turning on the spit.

Place the shelf with the food to be cooked in the 1st or 2nd position from the top.

Pre-heat the oven for 5 minutes. Turn the thermostat to a temperature between 50° and 200°.



Type de cuisson pour griller ou dorer les aliments.

Certains fours peuvent être munis d'un moteur de piques et d'une broche pour la cuisson en rôtissoire.

La grille portant l'aliment à cuire doit être insérée à la 1e ou 2e position du dessus.

Préchauffer pendant 5'. Tourner le bouton du thermostat sur une température comprise entre 50° et 200°.

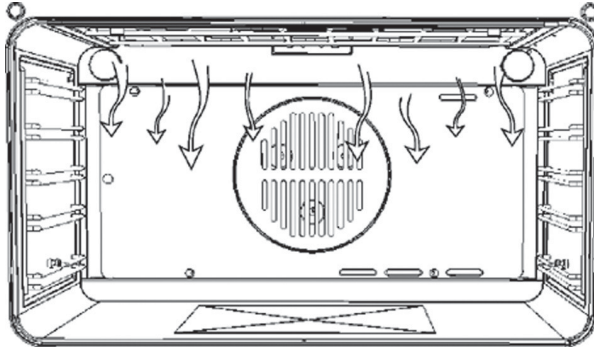
**VENTILATORE DI RAFFREDDAMENTO**

Il ventilatore è posto sulla parte superiore del forno e crea un circolo d'aria di raffreddamento all'interno del mobile e attraverso la porta del forno stesso.

Entra in funzione quando la parte esteriore del forno raggiunge i 60°C ca.

Accendendo il forno e impostando il termostato a 200°C, il ventilatore entra in funzione dopo 10 min ca.

Lo spegnimento del ventilatore avviene quando la parte esteriore del forno scende sotto i 60°C.

Dopo un utilizzo del forno a 200°C il ventilatore si spegne dopo 30 min. ca.

COOLING FAN

The fan is positioned on the upper part of the oven and create a circle of cooling air on the inside of the furniture and through the door of the oven.

It is turned on when the temperature of the outer shell of the oven reaches 60°C.

By switching on the oven with the thermostat at 200°C the fan starts working after approx. 10 min.

It is turned off when the temperature of the outer shell of the oven descends under 60°C.

By switching off the oven with the thermostat at 200°C the fan stops working after approx. 30 min.

VENTILATEUR DE REFROIDISSEMENT

Le ventilateur est placé sur la partie supérieure du four et crée une circulation d'air de refroidissement à l'intérieur du meuble et à travers la porte du four lui-même.

Il se met en marche quand la partie externe du four atteint environ 60°C.

En allumant le four et en programmant le thermostat sur 200°C, le ventilateur se met en marche après 10 minutes environ.

L'extinction du ventilateur se fait quand la partie externe du four descend sous 60°C.

Après une utilisation du four à 200°C, le ventilateur s'éteint après environ 30 minutes.

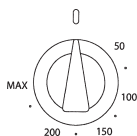
**TERMOSTATO**

Dispositivo che permette di regolare la temperatura di cottura più idonea ai cibi cuocere e può essere regolato da 50° a 250° C.

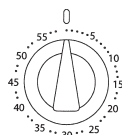
**CONTAMINUTI**

Segnalatore acustico da 0-60 minuti. Si deve ruotare la manopola in senso orario fino alla posizione massima per poi riportarla al tempo desiderato.

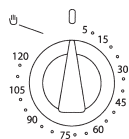
**TEMPORIZZATORE**

Impostare la manopola del commutatore e del termostato nella posizione e temperatura desiderata.

Per cotture a tempo *definito* ruotare la manopola a destra posizionandola nel tempo prestabilito. Si deve ruotare la manopola in senso orario fino alla posizione massima per poi riportarla al tempo desiderato. In seguito, un segnale acustico segnalerà che il tempo è trascorso e il forno cessa di funzionare.

Per cottura a tempo *indefinito* ruotare la manopola a sinistra portandola in corrispondenza del simbolo .

THERMOSTAT

Use the thermostat to set the cooking temperature you need. The thermostat can be adjusted from 50° to 250° C.

ALARM TIMER

You can set this timer to sound a buzzer after 0 to 60 minutes of cooking. First turn the knob fully clockwise, then turn it back to the desired alarm time.

COOKING TIMER

First, turn the cooking selector to the required cooking function, and the thermostat to the desired cooking temperature.

Then, to set *end of cooking time*, turn the cooking timer to the right and to the desired time. First turn the knob fully clockwise, then turn it back to the desired alarm time. A buzzer sounds at the end of the timed cooking period, and the oven switches itself off.

To set only the *start of cooking*, turn the cooking timer to the left to the  symbol.

THERMOSTAT

Dispositif permettant de régler la température de cuisson la plus indiquée pour les aliments et pouvant être réglé de 50° à 250° C.

MINUTEUR

Signaleur acoustique de 0-60 minutes. Tourner le bouton dans le sens des aiguilles d'une montre jusqu'à la position maximum, puis le remettre sur le temps désiré.

TEMPORISATEUR



Régler le bouton du commutateur et du thermostat sur la position et sur la température désirées.

Pour les cuissons à temps *défini*, tourner le bouton vers la droite en le réglant sur la durée préétablie. Tourner le bouton dans le sens des aiguilles d'une montre jusqu'à la position maximum, puis le remettre sur le temps désiré. Ensuite, un signal sonore indique que le temps prévu s'est écoulé et le four cesse de fonctionner.

Pour la cuisson à temps *indefini*, tourner le bouton vers la gauche en le mettant au niveau du symbole .

TIMER ELETTRONICO 6 TASTI

Regolazione dell'orologio

Premere contemporaneamente i tasti di durata  e fine cottura  ed agire sui tasti +/- fino all'impostazione dell'ora desiderata.

FUNZIONAMENTO MANUALE

Per cottura a tempo *indefinito* premere il tasto manuale .

FUNZIONAMENTO SEMIAUTOMATICO DI DURATA COTTURA



Per cottura a tempo *definito*. Premere il tasto di durata cottura ed impostare con i tasti +/- il tempo necessario per la cottura. Trascorso il tempo entra in funzione il segnale acustico ed il forno cessa di funzionare. Riportare la manopola del termostato e del commutatore in posizione 0 quindi premere il tasto manuale.

FUNZIONAMENTO SEMIAUTOMATICO DI FINE COTTURA

Per cottura a tempo *definito* premere il tasto di fine cottura  e impostare con i tasti +/- l'ora in cui si vuole che il forno cessi di funzionare. Trascorso il tempo entra in funzione il segnalatore acustico e il forno si arresta. Riportare la manopola del termostato e del commutatore in posizione 0 quindi premere il tasto manuale.

6 KEY ELECTRONIC TIMER

Setting the clock

Press the duration  key and the end of cooking  key simultaneously, then press the +/- keys to set the time.

MANUAL OPERATION

To start cooking without setting *end of cooking time*, press the manual key .

SETTING ONLY THE DURATION OF COOKING IN SEMI-AUTOMATIC MODE



To set the *duration of cooking*, press the duration key and press the +/- keys to set the duration of cooking. A buzzer sounds when the cooking period finishes, and the oven switches itself off. Turn the thermostat and selector knobs back to 0 position and press the manual key.

SETTING ONLY THE END OF COOKING TIME IN SEMI-AUTOMATIC MODE

To set the *end of cooking time*, press the end of cooking key  and press the +/- keys to set the time at which you want the oven to switch off. A buzzer sounds when the clock reaches the set time, and the oven switches itself off. Turn the thermostat and selector knobs back to 0 position and press the manual key.

TEMPORISATEUR ELECTRONIQUE A 6 TOUCHES

Réglage de l'horloge

Appuyer en même temps sur les touches de durée  et de fin de cuisson  et agir sur les touches +/- jusqu'au réglage de l'heure désirée.

FONCTIONNEMENT MANUEL

Pour les cuissons à temps *indefini*, appuyer sur la touche Manuel .

FONCTIONNEMENT SEMI- AUTOMATIQUE DE DUREE DE CUISSON



Pour les cuissons à temps *defini*. Appuyer sur la touche de durée de cuisson et, à l'aide des touches +/-, régler le temps nécessaire pour la cuisson. Le temps préétabli étant écoulé, le signal sonore retentit et le four s'arrête. Remettre le bouton du thermostat et du commutateur sur la position 0, puis appuyer sur la touche Manuel.

FONCTIONNEMENT SEMI- AUTOMATIQUE DE FIN DE CUISSON

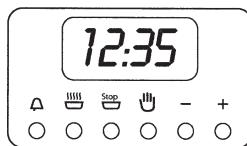
Pour les cuissons à temps *defini*, appuyer sur la touche de fin de cuisson  et, à l'aide des touches +/-, régler l'heure où l'on veut que le four cesse de fonctionner. Le temps préétabli étant écoulé, le signal sonore retentit et le four s'arrête. Remettre le bouton du thermostat et du commutateur sur la position 0, puis appuyer sur la touche Manuel.



FUNZIONAMENTO AUTOMATICO

Per cuocere a tempo *definito* premere il tasto di durata cottura  e impostare con i tasti +/- il tempo necessario per la cottura. Premere il tasto di fine cottura  e impostare l'ora in cui si vuole che il forno si arresti.

Al termine del programma il simbolo AUTO lampeggia, si mette in funzione il segnale acustico che dovrà essere spento premendo un tasto qualsiasi.

CONTAMINUTI

Premere il tasto contaminati e selezionare il tempo di cottura desiderato con il tasto +/- . Al termine del tempo impostato si mette in funzione il *segnale acustico* che può essere interrotto premendo uno qualsiasi dei tasti.



ERRORI DI PROGRAMMAZIONE

Si ha un errore di programmazione se l'ora indicata dall'orologio è compresa tra l'ora di inizio e l'ora di fine cottura. L'errore sarà segnalato acusticamente e mediante il lampeggio intermittente del simbolo AUTO. L'errore di impostazione può essere corretto variando la durata o il tempo di cottura.

ANNULLAMENTO PROGRAMMA

Un programma può essere annullato premendo il pulsante del funzionamento manuale.

FULLY AUTOMATIC OPERATION

To set the *end of cooking time*, press the duration key  and press the +/- keys to set the duration of cooking. Press the end of cooking key  and press the +/- keys to set the time at which you want the oven to switch off.

When you finish setting these times, the AUTO symbol flashes and the buzzer sounds. Press any key to silence it.

ALARM TIMER

Press the alarm timer key and press the +/- keys to set the required duration of cooking. The *buzzer* sounds when the cooking time ends. Press any key to silence it.



PROGRAMMING ERRORS

You cannot program a cooking period which starts earlier than the time displayed on the clock. If you try to do so, the buzzer sounds and the AUTO symbol flashes. Simply change the duration or cooking time to correct the error.

CANCELLING A COOKING PROGRAMME

To cancel a cooking programme, simply press the manual key.

FONCTIONNEMENT AUTOMATIQUE

Pour les cuissons à temps *défini*, appuyer sur la touche de durée cuisson  et, à l'aide des touches +/-, régler le temps nécessaire à la cuisson. Appuyer sur la touche de fin de cuisson  et régler l'heure où l'on veut que le four s'arrête.

A la fin du programme, le symbole AUTO clignote et le signal sonore qui retentit alors doit être interrompu en appuyant sur n'importe quelle touche.

MINUTEUR

Appuyer sur la touche du minuteur et sélectionner le temps de cuisson désiré avec la touche +/- . Le temps préétabli étant écoulé, le signal *sonore* qui retentit alors peut être interrompu en appuyant sur n'importe quelle touche.

ERREURS DE PROGRAMMATION

Il y a un erreur de programmation si l'heure indiquée par l'horloge est comprise entre l'heure de début et l'heure de fin de cuisson. L'erreur est indiquée par un signal sonore et par le clignotement du symbole AUTO. L'erreur de programmation peut être corrigée en modifiant la durée ou le temps de cuisson.

ANNULLATION DU PROGRAMME

Un programme peut être annulé en appuyant sur le bouton de fonctionnement manuel.

IT

SOSTITUZIONE DELLA LAMPADA DEL FORNO

IMPORTANTE:

La lampada del forno deve avere precise caratteristiche:

- a) struttura adatta alle alte temperature (fino a 300 gradi)
- b) alimentazione: vedere valore V/Hz indicato sulla targa matricola
- c) potenza 25 W.
- d) attacco di tipo E 14

Prima di procedere, staccare l'apparecchio dalla linea di alimentazione.

- per evitare danni, stendere nel forno uno strofinaccio per stoviglie
- svitare la protezione in vetro della lampada
- svitare la vecchia lampada e sostituirla con la nuova
- rimontare la protezione in vetro e togliere lo strofinaccio per stoviglie
- collegare nuovamente l'apparecchio alla linea di alimentazione.

GB

REPLACING THE OVEN LIGHT

IMPORTANT:

The oven light must have these precise features:

- a) it must be able to resist high temperatures (up to 300°C)
- b) power supply: see V/Hz indicated on data plate.
- c) power 25W.
- d) E 14 connection.

WARNING: Ensure that the appliance is switched off before replacing the lamp to avoid the possibility of electric shock.

- to prevent damage, place a tea cloth in the oven
- unscrew the glass cover of the light
- unscrew the old light bulb and replace it with the new one
- put back the glass cover and remove the tea cloth
- connect the appliance to the main electricity supply.

FR

REMPLACEMENT DE LA LAMPE DU FOUR

IMPORTANT:

La lampe du four doit répondre à des caractéristiques bien précises :

- a) structure adaptée à de hautes températures (jusqu'à 300 degrés)
- b) alimentation: voir valeur V/Hz indiquée sur la plaquette d'identification.
- c) puissance 25 W.

d) raccord de type E14
Avant de procéder à l'opération de remplacement, débrancher l'appareil du réseau d'alimentation,

- pour éviter tout endommagement, placer dans le four un essuie de vaisselle,
- dévisser la protection en verre de la lampe,
- dévisser la lampe usée et la remplacer par une nouvelle,
- remonter la protection en verre et enlever l'essuie de vaisselle,
- brancher à nouveau l'appareil au réseau d'alimentation.

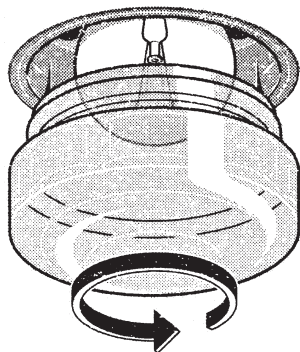

IT**GB****FR****SMONTAGGIO DELLA PORTA FORNO****REMOVING THE OVEN DOOR****DEMONTAGE DE LA PORTE DU FOUR**

Lo smontaggio della porta forno può essere facilmente effettuato operando come segue:

- aprire totalmente la porta;
- sollevare le due levette indicate in fig.;
- richiudere la porta sul primo scatto di arresto determinato dalle due levette sollevate in precedenza;
- sollevare la porta verso l'alto e verso l'esterno del forno per estrarla dalle sedi;

Per rimontare la porta, inserire le cerniere nelle apposite sedi e quindi riportare le due levette nella posizione di chiusura.

The oven door can be removed quickly and easily. To do so, proceed as follows:

- Open the door fully.
- Lift the two levers shown in fig.
- Close the door as far as the first stop (caused by the raised levers).
- Lift the door upwards and outwards to remove it from its mountings.

To replace fit the door, fit the hinges in their mountings and lower the two levers.

Le démontage de la porte du four peut être effectué facilement de la manière suivante :

- ouvrir complètement la porte;
- lever les deux manettes indiquées sur la fig.;
- refermer la porte sur le premier cran d'arrêt déterminé par les deux manettes soulevées au préalable;
- lever la porte vers le haut et vers l'extérieur du four pour l'ôter de son siège;

Pour remonter la porte, insérer les charnières dans les logements prévus à cet effet, puis remettre les deux manettes en position de fermeture.

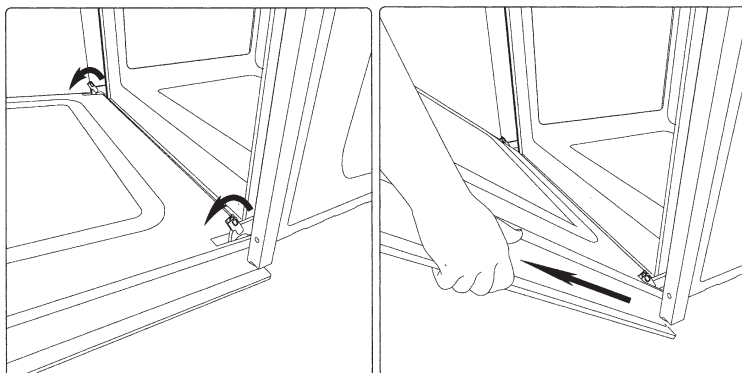

PER L'INSTALLATORE

INSTALLATION INSTRUCTIONS

POUR L'INSTALLATEUR

Incasso del forno

Flush fitting

Encastrement du four

Il forno può essere installato sotto un piano di cottura oppure in colonna. Le dimensioni dell'incasso devono essere come riportato in figura.

Il materiale del mobile deve essere in grado di resistere al calore. Il forno deve essere centrato rispetto alle pareti del mobile e fissato con le viti e bussole che sono fornite in dotazione.

The oven can be installed under a work top or in a cooking column. Figure shows the installation dimensions.

Make sure that surrounding materials are heat resistant. Align the oven centrally with respect to the side walls of the units surrounding it and fix it in place with the screws and Allen screws provided.

Le four peut être installé sous un plan de cuisson ou dans une colonne. Les dimensions de l'encastrement doivent correspondre à celles qui sont indiquées sur la figure.

Le matériau avec lequel le meuble est réalisé doit être en mesure de résister à la chaleur. Le four doit être centré par rapport aux parois du meuble et fixé avec les vis et les douilles fournies à cet effet.

ALLACCIAMENTO ELETTRICO

ELECTRICAL CONNECTIONS

BRANCHEMENT ELECTRIQUE

Prima di effettuare l'allacciamento elettrico accertarsi che:

- le caratteristiche dell'impianto siano tali da soddisfare quanto indicato sulla targa matricola applicata sul fronte del forno;
- l'impianto sia munito di un efficace collegamento di terra secondo le norme e le disposizioni di legge in vigore. La messa a terra è obbligatoria a termini di legge.

Il cavo in nessun punto dovrà raggiungere una temperatura superiore di 50° C quella ambiente.

Se un apparecchio fisso non è provvisto di cavo di alimentazione e di spina, o di altro dispositivo che assicuri la disconnessione dalla rete, con una distanza di apertura dei contatti che consenta la disconnessione completa nelle condizioni

Before connecting the oven to the mains power supply, make sure that:

- The supply voltage corresponds to the specifications on the data plate on the front of the oven.
- The mains supply has an efficient earth (ground) connection complying with all applicable laws and regulations. Correct earthing (grounding) is a legal requirement.

The power cable should never reach a temperature 50° C above ambient temperature at any point along its length.

If a fixed appliance is not provided with a power cable and plug, or some other device permitting it to be disconnected from the mains electricity supply, with a gap between the contacts big enough to guarantee class III

Avant d'effectuer le branchement électrique, s'assurer que :

- les caractéristiques de l'installation permettent de respecter ce qui est indiqué sur la plaque d'identification qui est appliquée sur le devant du four;

- l'installation est munie d'un raccordement à la prise de terre conforme aux normes et aux dispositions prévues par la loi. La mise à la terre est obligatoire aux termes de la loi.

Le câble ne doit en aucun cas atteindre une température supérieure de plus de 50° C par rapport à la température ambiante.

Si un appareil fixe n'a pas de cordon d'alimentation et de fiche ou d'autre dispositif assurant la déconnexion du secteur, avec une distance d'ouverture des contacts permettant une déconnexion

della categoria di sovratensione III, tali dispositivi di disconnessione devono essere previsti nella rete di alimentazione conformemente alle regole di installazione.

La presa o l'interruttore onnipolare devono essere facilmente raggiungibili con l'apparecchiatura installata.

overvoltage protection, then such a device must be fitted to the power supply in compliance with the regulations governing electrical installations.

The socket or switch must be easily reachable with the oven fully installed.

complète dans les conditions de la catégorie de surtension III, ces dispositifs de déconnexion doivent être prévus dans le réseau d'alimentation conformément aux normes d'installation.

La prise ou l'interrupteur onnipolaire doit pouvoir être atteint facilement lorsque l'appareil est installé.

**TIPI E DIAMETRO MINIMO DEI CAVI
CABLE TYPES AND MINIMAL DIAMETERS
TYPES ET DIAMÈTRE MINIMAUX DES CÂBLES**

		SASO	
H05RR-F	3x1,5 mm ²	H05RR-F	3x2,5 mm ²
H05VV-F	3x1,5 mm ²	H05VV-F	3x2,5 mm ²
H05RN-F	3x1,5 mm ²	H05RN-F	3x2,5 mm ²
H05V2V2-F	3x1,5 mm ²	H05V2V2-F	3x2,5 mm ²

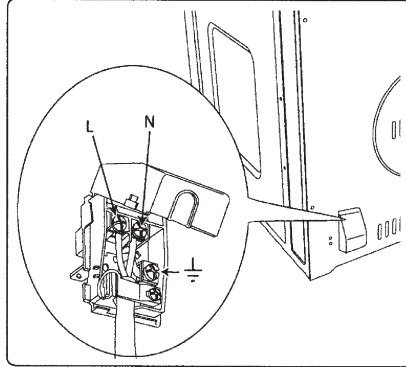

N.B. The manufacturer declines all responsibility for damage or injury if the above instructions and normal safety precautions are not respected.

WARNINGS

It is necessary to allow disconnection of the appliance from the supply after installation. The disconnection can be achieved by incorporating a switch in the fixed wiring in accordance with the wiring rules.

If the supply cord is damaged, it must be replaced by the manufacturer, its service agent or similarly qualified persons in order to avoid a hazard.

**CARATTERISTICHE TECNICHE - TECHNICAL FEATURES
 CARACTÉRISTIQUES TECHNIQUES
 TECHNISCHE DATEN - CARACTERÍSTICAS TÉCNICAS
 TECHNISCHE KENMERKEN - CARACTERÍSTICAS TÉCNICAS**

DIMENSIONI MUFFOLA	Larghezza (mm) Altezza (mm) Profondità (mm)	750 325 390	VOLUME UTILE (statico/ventilato)	103 litri
MUFFLE SIZE	Length (mm) Height (mm) Depth (mm)	750 325 390	CAVITY VOLUME (conventional/fan assisted)	103 litres
DIMENSIONS MOUFLE	Longueur (mm) Hauteur (mm) Profondeur (mm)	750 325 390	VOLUME UTILE (statique/ventilé)	103 litres
ABMESSUNGEN MUFFEL	Länge (mm) Höhe (mm) Tiefe (mm)	750 325 390	NUTZINHALT (Ober-Unterhitze/Umluft)	103 Liter
DIMENSIONES CÁMARA	Longitud (mm) Altura (mm) Profundidad (mm)	750 325 390	VOLUMEN ÚTIL (estático/aire)	103 litros
AFMETINGEN MOFFEL	Langte (mm) Hoogte (mm) Diepte (mm)	750 325 390	NUTTIG VOLUME (statisch/geventileerd)	103 liter
DIMENSÕES DA MUFLA	Comprimento (mm) Altura (mm) Profundidade (mm)	750 325 390	VOLUME ÚTIL (estático/ventilado)	103 litros

**ASSORBIMENTI ELEMENTI RISCALDANTI - HEATING ELEMENT POWER RATING
 CONSOMMATION ÉLÉMENTS CHAUFFANTS
 STROMAUFNAHME HEIZELEMENTE - ABSORCIÓN ELEMENTOS DE CALDEO
 STROOMOPNAME VERWARMINGSELEMENTEN - CONSUMO DOS ELEMENTOS DE AQUECIMENTO**

Elemento esterno resistenza cielo Roof element, external Élément extérieur résistance ciel Oberes äußeres Heizelement Elemento exterior resistencia techo Extern element weerstand bovenkant Elemento externo da resistência superior	1100 W
Elemento interno resistenza cielo Roof element, internal Élément intérieur résistance ciel Oberes inneres Heizelement Elemento interior resistencia techo Intern element weerstand bovenkant Elemento interno da resistência superior	1750 W
Elemento circolare Circular element Élément circulaire Rundes Heizelement Elemento circular Rond element Elemento circular	2300 W
Elemento suola Bottom element Élément sole Unteres Heizelement Elemento suelo Element bodem Elemento inferior	1300 W

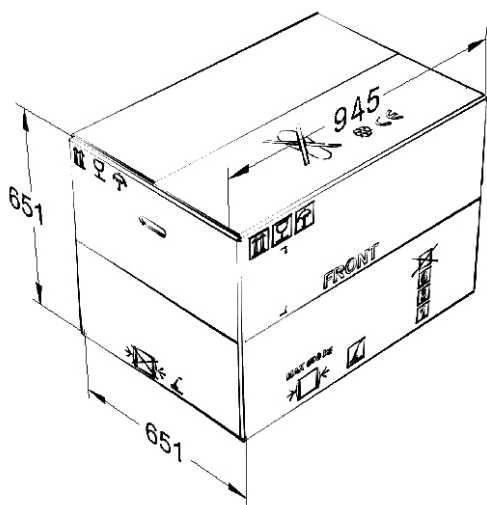
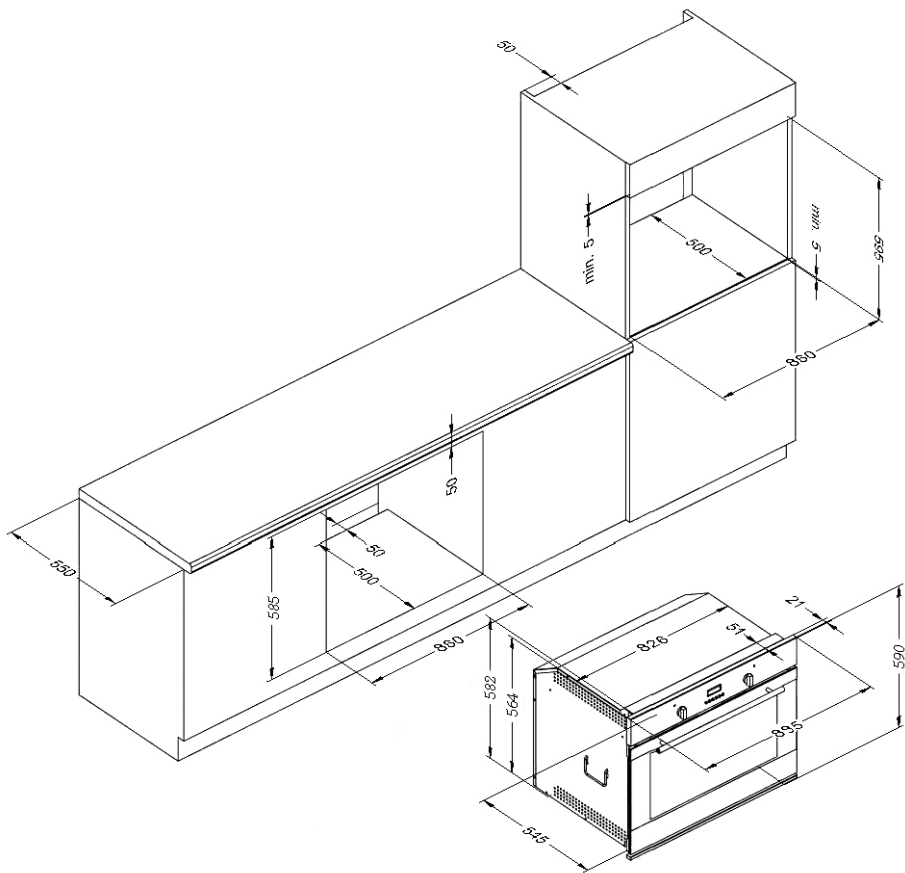

NOTE: Ensure you secure the oven to the kitchen cabinets with the screws provided using the screw holes in the oven cavity

La Casa costruttrice declina ogni responsabilità per le possibili inesattezze contenute nel presente opuscolo, imputabili ad errori di stampa o di trascrizione. Si riserva il diritto di apportare ai propri prodotti quelle modifiche che ritiene necessarie o utili, senza pregiudicare le caratteristiche essenziali.

The manufacturer declines all responsibility for possible inaccuracies contained in this pamphlet, due to printing or copying errors. We reserve the right to make on our own products those changes to be considered necessary or useful, without jeopardizing the essential characteristics.

Dans un souci constant d'amélioration qualitative, le constructeur se réserve la possibilité d'apporter à ses produits les modifications utiles, sans compromettre ses caractéristiques essentielles. Le constructeur décline toutes responsabilités pour d'éventuelles inexactitudes contenues dans cette notice, imputables à des erreurs d'impression ou de transcription.

Die Herstellerfirma übernimmt keinerlei Verantwortung für eventuell in dieser Broschüre enthaltene Ungenauigkeiten, die auf Druckfehler zurückzuführen sind und behält sich das Recht vor an ihren Produkten alle für notwendig erachteten Änderungen anzubringen, ohne die wesentlichen Eigenschaften zu beeinflussen.

El fabricante declina toda responsabilidad por las posibles inexactitudes contenidas en el presente documento, imputables a errores de impresión o relacionadas. El fabricante se reserva el derecho de aportar a sus propios productos aquellas modificaciones que se considere necesarias o útiles, sin perjudicar las características esenciales.

De Fabrikant wijst iedere verantwoordelijkheid af voor enige onjuistheden in deze brochure welke geweten kunnen worden aan copie - of drukfouten. Hij behoudt zich het recht voor aan zijn eigen produkten wijzigingen aan te brengen die hij noodzakelijk of nuttig acht zonder dat de wezenlijke kenmerken erdoor veranderd worden.

O Fabricante não assume nenhuma responsabilidade acerca de eventuais inexactidões contidas na presente publicação, devidas a erros de impressão ou de transcrição. Reserva-se o direito de efectuar nos próprios produtos as eventuais modificações que considerar necessárias ou úteis, sem prejudicar as características essenciais.



Worldwide Appliances Pty Limited
A.B.N. 45868077422

Office:
48-50 Moore Street, Leichhardt N.S.W 2040
Post:
Locked Bag 3000, Annandale, N.S.W 2038
P: 1300 694 583

WARRANTY REGISTRATION

Your ongoing satisfaction with your artusi product is important to us. We ask that you complete the enclosed Warranty Registration Card and return it to us so that we have a record of the artusi product purchased by you.

PRIVACY

Worldwide Appliances respects your privacy and is committed to handling your personal information in accordance with the National Privacy Principles and the Privacy Act 1988 (Cth). A copy of the Worldwide Appliances Privacy Policy is available at www.artusi.com.au. Worldwide Appliances will not disclose any personal information set out in the Warranty Registration Card ("Personal Information") without your consent unless required by:

1. law;
2. any Worldwide Appliances related company;
3. any service provider which provide services to artusi or assist artusi in providing services (including repair and warranty services) to customers. Our purpose in collecting the Personal Information is to keep a record of the artusi product purchased by you, in order to provide a better warranty service to you in the unlikely event that there is a problem with your artusi product. Worldwide Appliances may contact you at any one or more of the address, email address or telephone numbers set out in the Warranty Registration Card. Please contact artusi on 1300 694 583 should you not wish to be contacted by Worldwide Appliances.

WARRANTY

1. Warranty

Worldwide Appliances warrants that each artusi product will remain, for a period of either 12 months or 24 months of warranty. All Warranties are valid from the original date of purchase, And warranty claims must be accompanied by the proof of purchase.

24 months warranty products:

All Built-in Appliances – Limited to Ovens, Gas, Induction and Electric Cooktops, and All Rangehoods

Freestanding Cookers - Gas and Electric Models (900mm Width)

Dishwashers - Freestanding, Fully Integrated, Semi Integrated and built-in

12 months warranty products:

Freestanding Cookers - Gas and Electric Models in 50cm, 54cm and 60cm Widths

Portable Appliances* – Benchtop Models and Portable Gas Models

2. What is not Covered by the Warranty.

The Warranty does not apply if an artusi product is defective by a factor other than a defect arising in the manufacture of the artusi product, including but not limited to:

- (a) damage through misuse (including failure to maintain, service or use with proper care), neglect, accident or ordinary wear and tear (including deterioration of parts and accessories and glass breakage);
- (b) use for purpose for which the artusi product was not sold or designed;
- (c) use or installation which is not in accordance with any specified instructions for use or installation;
- (d) use or operation after a defect has occurred or been discovered;
- (e) damage through freight, transportation or handling in transit (other than when Worldwide Appliances is responsible);
- (f) damage through exposure to chemicals, dusts, residues, excessive voltage, heat, atmospheric conditions or other forces or environmental factors outside the control of Worldwide Appliances;
- (g) repair, modification or tampering by the purchaser or any person other than Worldwide Appliances, an employee of Worldwide Appliances or an authorised artusi service contractor*;
- (h) use of parts, components or accessories which have not been supplied or specifically approved by artusi.
- (i) damage to surface coatings caused by cleaning or maintenance using products not recommended in the artusi product handbook provided to the purchaser upon purchase of the artusi product;
- (j) damage to the base of an electric oven due to items having been placed on the base of the oven cavity or covering the base, such as aluminium foil (this impedes the transfer of heat from the element to the oven cavity and can result in irreparable damage); or
- (k) damages, dents or other cosmetic imperfections not affecting the performance of the artusi in respect of an artusi product purchased as a "factory second" or from display

The Warranty does not extend to light globes used in artusi products.

3. Domestic Use

Each artusi product is made for domestic use. This Warranty may not extend to artusi products used for commercial purposes.

Continued over...

4. Time for Claim under the Warranty

You must make any claim under this Warranty within twenty eight (28) days after the occurrence of an event which gives rise to a claim pursuant to the Warranty, by booking a service call on the telephone number below.

5. Proof of Purchase

Customers must retain proof of purchase in order to be eligible to make a warranty claim in respect of an artusi product.

6. Claiming under the Warranty

Customers will bear the cost of claiming under this Warranty unless Worldwide Appliances determines the expenses are reasonable, in which case the customer must claim those expenses by providing written evidence of each expense to Worldwide Appliances at the address on the Warranty Registration Card.

7. Statutory Rights

(a) These terms and conditions do not affect your statutory rights.

(b) The limitations on the Warranty set out in this document do not exclude or limit the application of the consumer guarantees set out in the Act or any other equivalent or corresponding legislation in the relevant jurisdiction where to do so would:

(i) contravene the law of the relevant jurisdiction; or

(ii) cause any part of the Warranty to be void.

(c) Worldwide Appliances excludes indirect or consequential loss of any kind (including, without limitation, loss of use of the artusi product) and (other than expressly provided for in these terms and conditions) subject to all terms, conditions and warranties implied by custom, the general law, the Act or other statute.

(d) The liability of Worldwide Appliances to you

for a breach of any express or non-excludable implied term, condition or warranty is limited at the option of Worldwide Appliances to:

(i) replacing or repairing the defective part of the artusi product;

(ii) paying the cost of replacing or repairing the defective part of the artusi product;

(iii) replacing the artusi product; or

(iv) paying the cost of replacing the artusi product.

(e) Our goods come with guarantees that cannot be excluded under the Australian Consumer Law. You are entitled to a replacement or refund for a major failure and for compensation for any other reasonably foreseeable loss or damage. You are also entitled to have the goods repaired or replaced if the goods fail to be of acceptable quality and the failure does not amount to a major failure.

8. Defects

Any part of an artusi product deemed to be defective and replaced by Worldwide Appliances is the property of Worldwide Appliances. Worldwide Appliances reserves the right to inspect and test artusi products in order to determine the extent of any defect and the validity of a claim under the Warranty.

*To locate your closest artusi authorised service agent please contact us on 1300 652 100 or visit www.artusi.com.au

ALL SERVICE CALLS MUST BE BOOKED THROUGH AN AUTHORISED DEALER OR WARRANTY DEPARTMENT ON 1300 652 100 OR stokesaps.com.au/artusi-service

01032014



Warranty Card tear off

WARRANTY REGISTRATION CARD
01052013

Please complete and send to ARTUSI at: REPLY PAID 83617
LEICHHARDT NSW 2040

Last Name:		First Name:	
Address:			
State:	Postcode:	Email:	
Home Phone:		Mobile:	
Purchase Date: / /		(Please attach proof of purchase to validate warranty)	

MODEL NUMBER	SERIAL NUMBER (if you cannot locate the serial number please call ARTUSI on 1300 694 583)
1	
2	
3	
4	

01032014





DISCLAIMER

Worldwide Appliances PTY LTD, trading as ARTUSI, is continually seeking ways to improve the design specifications, aesthetics and production techniques of its products. As a result alterations to our products and designs take place continually. Whilst every effort is made to produce information and literature that is up to date, this brochure should not be regarded as an infallible guide to the current specifications, nor does it constitute an offer for the sale of any particular product. Product dimensions indicated in our literature is indicative only. Actual product only should be used to define dimension cutouts. Distributors, and retailers are not agents of ARTUSI and are not authorised to bind ARTUSI by any express or implied undertaking or representation.

ARTUSI OFFICES ARE OPEN DAILY FROM 9AM-5PM AND SATURDAYS 10AM-4PM

NSW & ACT (HEAD OFFICE)
48-50 MOORE STREET
LEICHHARDT
F 02 8569 4699

VIC, TAS & SA
1211 TOORAK ROAD
CAMBERWELL
F 03 9809 2155

QLD
1/42 CAVENDISH ROAD
COORPAROO
F 07 3397 0850

WA & NT
UNIT 10/55 HOWE STREET
OSBORNE PARK
F 08 9201 9188

NZ
PO BOX 11160
SOCKBURN CHRISTCHURCH
F 03 344 5906

P: 1300 649 583

ARTUSI.COM.AU

