

## Operating and installation instructions Cooker hood



To prevent the risk of accidents or damage to the appliance, it is **essential** to read these instructions before it is installed and used for the first time.

# Contents

---

<b>Warning and Safety instructions</b> .....	4
<b>Caring for the environment</b> .....	13
<b>Guide to the cooker hood</b> .....	14
<b>Modes of operation</b> .....	16
<b>Operation</b> .....	17
Switching the fan on.....	17
Selecting the power level .....	17
Run-on time.....	17
Switching the fan off .....	17
Switching the hob lighting on/off .....	17
Power management .....	17
Switching Power management on/off .....	18
Safety switch-off .....	18
<b>Energy saving tips</b> .....	19
<b>Cleaning and care</b> .....	20
Housing .....	20
Important information for appliances with lacquered casing .....	20
Grease filters .....	21
Charcoal filter .....	23
Disposing of charcoal filters .....	23
Changing a lamp .....	24
<b>Service</b> .....	25
Contact in the event of a fault .....	25
Position of the data plate .....	25
Warranty .....	25
<b>Installation</b> .....	26
Before installation.....	26
Protective foil.....	26
Installation materials.....	26
Appliance dimensions .....	28
Safety distance between hob and cooker hood (S) .....	29
Installation recommendations .....	30
Drilling diagram for wall mounting.....	30
Connection for air extraction.....	31
Non-return flap .....	31
Condensation .....	31
Silencer.....	32

# Contents

---

Electrical connection .....	33
<b>Technical data</b> .....	34
Optional accessories for recirculation mode.....	34



## Warning and Safety instructions

---

This cooker hood complies with all relevant local and national safety requirements. Inappropriate use can, however, lead to personal injury and material damage.

Read the operating and installation instructions carefully before using the cooker hood. They contain important information on its safety, installation, use and maintenance. This prevents both personal injury and damage to the cooker hood.

In accordance with standard IEC 60335-1, Miele expressly and strongly advises that you read and follow the instructions in the chapter on installing the appliance as well as the safety instructions and warnings.

Miele cannot be held liable for injury or damage caused by non-compliance with these instructions.

Keep these instructions in a safe place and pass them on to any future owner.

### Correct application

▶ This cooker hood is intended for use in domestic households and similar working and residential environments.

▶ The cooker hood is not intended for outdoor use.

▶ It must only be used as a domestic appliance to extract vapours and remove odours from cooking.

Any other usage is not supported by the manufacturer and could be dangerous.

▶ Where a recirculation cooker hood is fitted above a gas hob, please ensure that there is an adequate supply of fresh air into the room in which it is installed. Please seek the advice of a qualified gas fitter (e.g. GasSafe in the UK) for more information if necessary.

# Warning and Safety instructions

---

▶ The cooker hood can only be used by people with reduced physical, sensory or mental capabilities, or lack of experience and knowledge, if they are supervised whilst using it, or have been shown how to use it in a safe way and recognise and understand the consequences of incorrect operation.

## Safety with children

- ▶ Children under 8 years of age must be kept away from the cooker hood unless they are constantly supervised.
- ▶ Children aged 8 and older may only use the cooker hood without supervision if they have been shown how to use it and are able to do so in a safe manner. Children must be able to understand and recognise the possible dangers caused by incorrect operation.
- ▶ Children must not be allowed to clean or maintain the cooker hood unsupervised.
- ▶ Please supervise children in the vicinity of the cooker hood and do not let them play with it.
- ▶ The hob lighting is very intensive.  
Ensure, in particular, that babies/small children do not look at the light.
- ▶ Danger of suffocation! Whilst playing, children may become entangled in packaging material (such as plastic wrapping) or pull it over their head with the risk of suffocation. Keep packaging material away from children.

# Warning and Safety instructions

---

## Technical safety

- ▶ Unauthorised installation, maintenance and repairs can cause considerable danger for the user. Installation, maintenance and repairs must only be carried out by a Miele authorised technician.
- ▶ A damaged appliance can be dangerous. Check it for visible signs of damage. Do not use a damaged appliance.
- ▶ The electrical safety of this appliance can only be guaranteed when correctly earthed. It is essential that this standard safety requirement is met. If in any doubt please have the electrical installation tested by a qualified electrician.
- ▶ Reliable and safe operation of this cooker hood can only be assured if it has been connected to the mains electricity supply.
- ▶ The connection data (voltage and frequency) on the data plate of the cooker hood must match the mains electricity supply in order to avoid the risk of damage to the cooker hood  
Compare this before connecting the appliance to the mains. Consult a qualified electrician if in any doubt.
- ▶ Do not connect the appliance to the mains electricity supply by a multi-socket unit or an extension lead. These are a fire hazard and do not guarantee the required safety of the appliance.

## Warning and Safety instructions

---

- ▶ For safety reasons, this appliance may only be used after it has been built in.
- ▶ The cooker hood must not be used in a non-stationary location (e.g. on a ship).
- ▶ Touching electrical components and tampering with electrical and mechanical parts is highly dangerous to the user and can cause operational faults.  
Only open the housing as described in the instructions given in the installation sheet and in the Cleaning and care section of this booklet. Under no circumstances should any other parts of the housing be opened.
- ▶ The manufacturer's warranty will be invalidated if the appliance is not repaired by a Miele authorised technician.
- ▶ Miele can only guarantee the safety of the appliance when genuine original Miele replacement parts are used. Faulty components must only be replaced by Miele spare parts.
- ▶ If the electrical connection cable is faulty it must only be replaced by a Miele authorised technician to protect the user from danger.
- ▶ During installation, maintenance and repair work, the appliance must be disconnected from the mains electricity supply.

# Warning and Safety instructions

Using at the same time as another heating appliance that depends on the air from the room

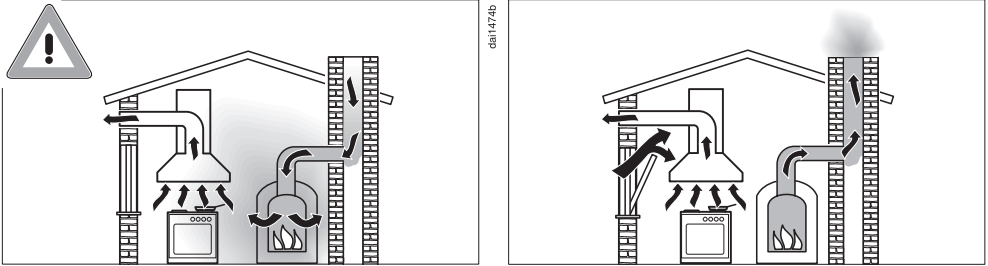

## Danger of toxic fumes!

Great care should be taken when using the cooker hood in the same room or the same area of the house at the same time as another heating appliance that depends on the air from the room. Such heating appliances draw in air from the room and duct exhaust gases out through a chimney or extraction ducting. They include gas, oil, wood and coal-fired boilers and heaters, continuous flow or other water heaters, gas hobs and ovens.

The cooker hood draws in air from the kitchen and from neighbouring rooms. This applies to the following modes of operation:

- Extraction mode
- Recirculation mode with a recirculation box installed outside the room.

If there is insufficient air, negative pressure will occur. The heating appliance may be starved of oxygen. This impairs combustion. Harmful gases could be drawn from the chimney or extraction ducting back into the room.

**Risk of death!**

## Warning and Safety instructions

---

In order to ensure safe operation and to prevent gases given off by the heating appliance from being drawn back into the room when the cooker hood and the heater are both operated simultaneously, an underpressure in the room of 0.04 mbar (4 Pa) is the maximum permissible.

Sufficient ventilation can be maintained by air inlets which cannot be blocked, e.g. in windows, doors and outside wall vents. The cross-section of the inlet openings must enable sufficient ventilation. A ventilation brick alone is not generally sufficient to ensure safe ventilation.

The overall ventilation condition of the dwelling must be taken into account. If in any doubt, ask a competent building regulations inspector or qualified gas fitter (if appropriate).

If the cooker hood is being operated in recirculation mode, whereby the air is redirected into the room in which it is installed, the above restrictions do not apply.

# Warning and Safety instructions

---

## Correct use

▶ Open flames are a fire hazard.

The use of an open flame under the cooker hood is not permitted. To avoid the danger of fire, do not flambé or grill over an open flame.

When switched on, the cooker hood could draw flames into the filter. Fat deposits could ignite, presenting a fire hazard.

▶ The cooker hood can become damaged when exposed to excessive heat.

- When using the cooker hood over a gas hob, ensure that any burners in use are always covered by a pan. Switch the cooking zone off when a pan is removed, even for a short time.
- Select a pan which is suitable for the size of the burner.
- Regulate the flame so that it does not burn up the sides of the pan.
- Avoid overheating the pan (e.g. when cooking with a wok).

▶ Always switch the cooker hood on when a cooking zone is in use, otherwise condensation may collect in the hood, which could cause corrosion.

▶ Overheated oil and fat can ignite, causing fire damage to the cooker hood.

When cooking with oil or fat, chip pans and deep fat fryers, etc, do not leave the pans unattended. Similarly, never leave an open grill unattended when grilling.

## Warning and Safety instructions

---

▶ Do not use the cooker hood without the filters in place. This way you will avoid the risk of grease and dirt getting into the appliance and hindering its smooth operation.

▶ The cooker hood can get very hot during cooking due to heat rising from the hob.

Do not touch the housing or the grease filters until the cooker hood has cooled down.

### Proper installation

▶ Refer to the cooker or hob manufacturer's instructions as to whether a cooker hood may be operated above the cooker/hob.

▶ Safety regulations prohibit the fitting of a cooker hood over solid fuel stoves.

▶ An insufficient safety distance between the hob and the cooker hood can result in damage to the cooker hood.

The minimum safety distances between the top of the hob and the bottom of the cooker hood given in the “Installation” section of this manual must be observed, unless the hob manufacturer states that a greater safety distance is required.

If more than one cooking appliance is fitted beneath the cooker hood, and they have different minimum safety distances to the cooker hood, select the greater distance.

▶ The information provided in “Installation” must be observed when fixing the ventilation hood.

▶ Components can have sharp edges which may cause injury. Wear gloves to protect your hands from being cut.

▶ Exhaust ducting must be of non-inflammable material. Suitable material is available from Miele specialist dealers or the Miele Spares Dept.

▶ The appliance must not be connected to a chimney or flue which is in use. Neither should it be connected to ducting which ventilates rooms with fireplaces.

## Warning and Safety instructions

---

▶ If exhaust air is to be extracted into a chimney or ventilation duct no longer used for other purposes, seek professional advice.

### Cleaning and care

▶ There is a risk of fire if the cooker hood is not cleaned as described in these operating instructions.

▶ Do not use a steam cleaning appliance to clean this appliance. The steam could reach electrical components and cause a short circuit.

### Accessories

▶ Only use genuine original Miele accessories and spare parts with this appliance. Using accessories or spare parts from other manufacturers will invalidate the warranty and Miele cannot accept liability.

### Disposal of the packing material

The packaging is designed to protect the appliance from damage during transportation. The packaging materials used are selected from materials which are environmentally friendly for disposal and should be recycled.

Recycling the packaging reduces the use of raw materials in the manufacturing process and also reduces the amount of waste in landfill sites.

### Disposing of your old appliance

Electrical and electronic appliances often contain valuable materials. They also contain specific materials, compounds and components, which were essential for their correct function and safety. These could be hazardous to human health and to the environment if disposed of with your domestic waste or if handled incorrectly. Please do not, therefore, dispose of your old appliance with your household waste.



Please dispose of it at your local community waste collection / recycling centre for electrical and electronic appliances, or contact your dealer or Miele for advice. You are also responsible for deleting any personal data that may be stored on the appliance being disposed of. Please ensure that your old appliance poses no risk to children while being stored prior to disposal.

# Guide to the cooker hood

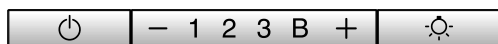
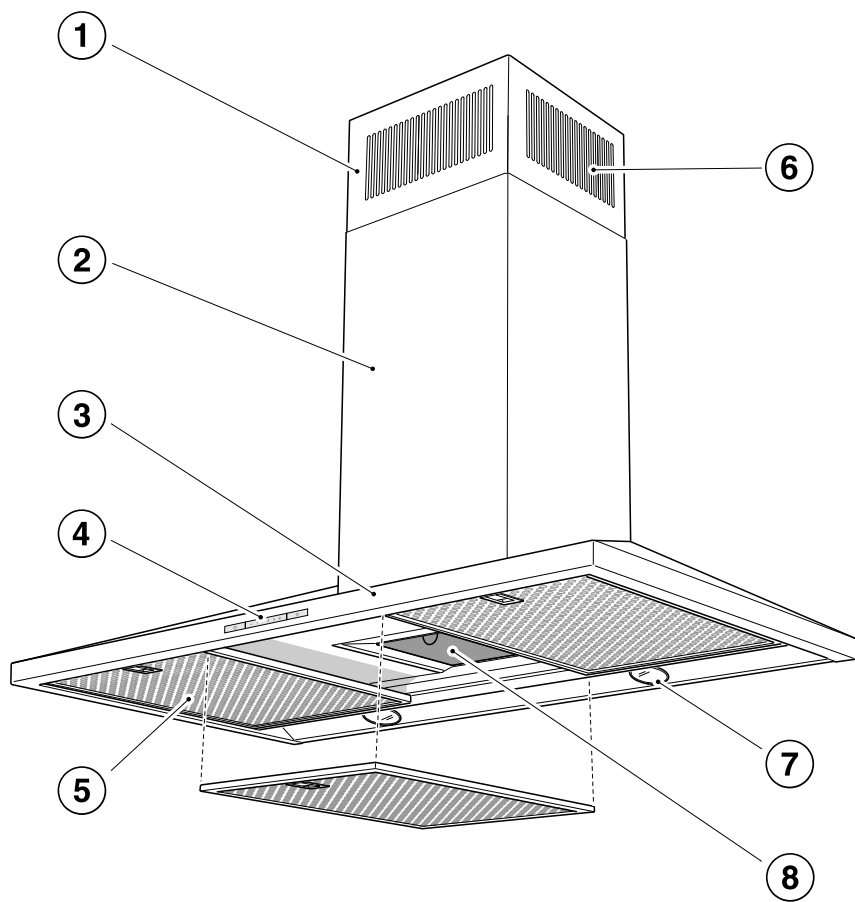

9

10

11

- ① Telescopic extension piece
- ② Tower
- ③ Canopy
- ④ Control elements
- ⑤ Grease filters
- ⑥ Recirculation grille  
Only for recirculation mode
- ⑦ Hob lighting
- ⑧ Charcoal filter  
Disposable or reactivatable charcoal filter  
Optional accessory for recirculation mode
- ⑨ Control for switching the fan on and off
- ⑩ Controls for setting the fan power level
- ⑪ Control for switching the lighting on and off

# Modes of operation

---

Depending on the model of the cooker hood, the following options are available:

## Extraction mode



da10494a

The air is drawn in and cleaned by the grease filters and directed outside.

## Recirculation mode

(recirculation mode cooker hoods require a conversion kit and charcoal filter, see “Technical Data”)



da10494b

The air is drawn in and cleaned first by the grease filters and then by a charcoal filter. The cleaned air is then recirculated back into the kitchen.

## Switching the fan on

Switch the fan on as soon as you start cooking. This is to ensure that vapours are captured right from the start.

- Press the On/Off control .

The fan will switch on at setting **2** and the  symbol and **2** will light up in the power setting display.

## Selecting the power level

For light to heavy cooking vapours and odours, select from power levels **1** to **3**.

For short periods of cooking food with intensive vapours and a strong aroma, e.g. when searing meat, select Booster setting **B**.

- Select the power level you want by pressing the **-** or **+** control.

## Reducing power down from the Booster setting

If power management is activated (default setting), the fan automatically switches back to level **3** after 5 minutes.

## Run-on time

- It is advisable to run the fan for a few minutes after cooking has finished.

This helps to remove any lingering vapours and odours from the air.

It also reduces the risk of residues accumulating in the cooker hood and any resultant odours.

## Switching the fan off

- Press the On/Off control  to switch the fan off.

The  symbol will go out.

## Switching the hob lighting on/off

The hob lighting can be switched on and off independently of the fan.

- To do so press the lighting control .

The  symbol will light up when the hob lighting is switched on.

## Power management

The cooker hood is fitted with a power management system. Power management helps to save energy. It ensures that the fan power level is reduced automatically and that the lighting is switched off.

- If the Booster setting has been selected, the fan will automatically switch to level 3 after 5 minutes.
- From fan power levels 3, 2 or 1, the power will be reduced by one level after 2 hours and then in 30-minute stages until the fan finally switches off.
- The hob lighting will switch off automatically after 12 hours.



# Operation

---

## Switching Power management on/off

You can deactivate Power management.

This can result in increased electricity consumption.

- To set this option, both the fan and the hob lighting must be switched off.
- Press the “—” and “+” controls at the same time for approx. 10 seconds, until the **1** lights up.
- Then press in turn,
  - the lighting control ,
  - the “—” button and then
  - the lighting control  again.

If Power management is switched on, the **1** and **B** indicators will light up constantly.

If it is switched off, **1** and **B** will flash.

- Press “—” to switch Power management off.

The **1** and **B** indicators will flash.

- To switch it on, press “+”.

The **1** and **B** indicators will light up constantly.



- Confirm your choice with the On/Off control .

All the indicator lamps will go out.

If you do not confirm within 4 minutes, the cooker hood will revert to the old setting.

## Safety switch-off

If Power management has been deactivated, the cooker hood will switch itself off automatically after 12 hours if it has been left on (fan and hob lighting).

- To switch it on again press the On/Off  control or the lighting control .

This cooker hood operates very efficiently and economically. The following will help you to save even more energy when using it:

- Ensure that there is sufficient ventilation in the kitchen when cooking. In extraction mode, if there is insufficient air flow the cooker hood cannot operate efficiently and this causes increased operating noise levels.
- Always cook with the lowest possible setting. This produces fewer cooking vapours, so you can use a lower cooker hood power level and therefore benefit from reduced energy consumption.
- Check the power level selected on the cooker hood. A lower power level is generally sufficient for the majority of cooking. Only use the Booster setting when necessary.
- When a large volume of cooking vapours is being produced, switch to a high power level in good time. This is more efficient than operating the cooker hood for longer to try to capture cooking vapours which have already been distributed throughout the kitchen.
- Make sure that you switch the cooker hood off after use.
- Clean or change the filters at regular intervals. Heavily soiled filters reduce performance, increase the risk of fire and are unhygienic.

# Cleaning and care

 Before proceeding with any maintenance or cleaning task, the cooker hood must be disconnected from the power supply (see “Warning and Safety instructions”).

## Housing

### General information

Unsuitable cleaning agents can damage the surfaces and control elements.

Do not use any cleaning agents containing soda, acid, chloride or solvent.

Do not use any abrasive cleaning agents, e.g. powder cleaners or cream cleaners and abrasive sponges, as well as pot scourers or sponges which have been used previously with abrasive cleaning agents.

 Moisture in the cooker hood can cause damage.  
Make sure that water does not get into the cooker hood.

- All external surfaces and control elements can be cleaned using hot water with a small amount of washing-up liquid applied with a well wrung-out soft sponge or cloth.
- After cleaning, wipe the surfaces dry using a soft cloth.

### Important information for appliances with stainless steel surfaces

This information does not apply to the control buttons.

Stainless steel surfaces can be cleaned with a non-abrasive cleaning agent designed specifically for use on stainless steel.

To prevent the surfaces from quickly becoming dirty again, we recommend treating them with a stainless steel care product (available from Miele).

### Important information for appliances with lacquered casing

(Customisation on request)

Minor scratches on the surface are inevitable when cleaning the casing; they may be visible depending on the lighting in the kitchen.

## Important information for the control elements

If soiling is not removed promptly, it could cause the control elements to alter or discolour.

Remove any soiling immediately.

The surface of the control elements can become damaged if they are cleaned using stainless steel cleaning agents.

Do not use stainless steel cleaning agents on the control elements.

## Grease filters

 Fire hazard

Oversaturated grease filters are a fire hazard.

Clean the grease filters at regular intervals.

The re-usable metal grease filters in the appliance remove solid particles (grease, dust, etc.) from the kitchen vapours, preventing soiling of the cooker hood.

The grease filters must be cleaned at regular intervals.

Heavily soiled grease filters hinder air extraction and will lead to increased levels of soiling in the cooker hood and in the kitchen.

## Cleaning interval

Accumulated grease solidifies over a longer period of time and makes cleaning more difficult. The grease filters should therefore be cleaned every 3 to 4 weeks.

## Removing a grease filter

 When handling a grease filter, be careful not to drop it.

This can result in damage to the filter and the hob below.

Make sure you hold the filter securely at all times when handling it.

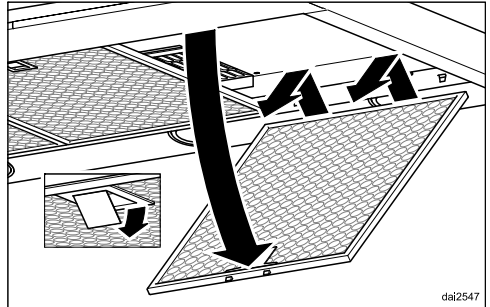

- To take out a grease filter, release the locking clip on the filter, lower the filter approx. 45°, unhook it at the back and remove it.

# Cleaning and care

## Cleaning the grease filters by hand

- Clean the filters with a soft nylon brush in a mild solution of hot water and a small amount of washing-up liquid. Do not use “neat” washing up liquid.

## Unsuitable cleaning agents

Unsuitable cleaning agents can cause damage to the surface of the filters if used regularly.

Do not use:

- cleaning agents containing descaling agents
- powder cleaners, cream cleaners
- aggressive multi-purpose cleaning agents or spray cleaners for grease
- oven sprays

## Cleaning the grease filters in the dishwasher

- Place the grease filters upright or slightly inclined in the lower basket. Ensure the spray arm is not obstructed.
- Use a commercially available household dishwasher detergent.
- Select a dishwasher programme with a wash temperature between 50 °C and 65 °C.

Depending on the detergent used, cleaning the filters in a dishwasher may cause the inside filter surfaces to become discoloured. This will not affect the functioning of the grease filters in any way.

## After cleaning

- After cleaning, leave the filters to dry on an absorbent surface before replacing them.
- When removing the filters for cleaning, also clean off any residues of oil or fat from the now accessible housing to prevent the risk of these catching fire.
- Replace the grease filters, making sure that the locking clips are facing down towards the hob.

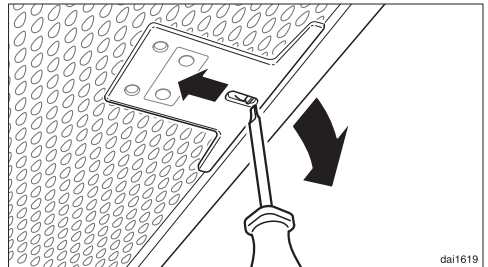

- If a grease filter is inadvertently replaced upside down, insert a small screwdriver blade into the slit to disengage the clip.

## Charcoal filter

With recirculation mode, a charcoal filter must be fitted in addition to the grease filters. The charcoal filter is designed to absorb cooking odours.

The charcoal filter is fitted in the canopy above the grease filters.

Charcoal filters are available to order via the Miele online shop, the Miele Customer Service Department (see end of these operating instructions for contact details) or from your Miele dealer. The model designation required is listed under "Technical data".

## Fitting/replacing a charcoal filter

- Remove the grease filter before fitting or replacing a charcoal filter.
- Take the charcoal filter out of its packaging.

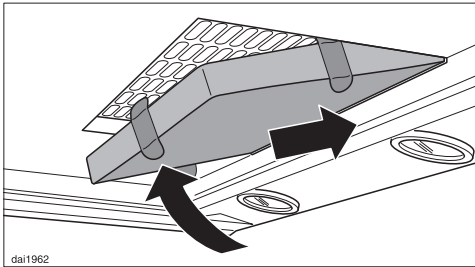

- Insert the charcoal filter into the back of the charcoal filter frame, then push up into the frame at the front.
- Refit the grease filters.

## When to change the charcoal filter

- Replace the charcoal filter when it no longer absorbs kitchen odours effectively.  
It should, however, be replaced at least every 6 months.

## Disposing of charcoal filters

- Used charcoal filters can be disposed of with normal household waste.

# Cleaning and care

## Changing a lamp

The lamps should be replaced with a lamp of the same type:

Manufacturer .....	EGLO
Lamp type .....	GU10
Specification.....	11427
Wattage .....	3 W
ILCOS D Code.....	DR-3-H-GU10-50/56

Alternatively the following lamps can be used:

Manufacturer .....	EGLO
Lamp type .....	GU10
Specification.....	11511
Wattage .....	5 W
ILCOS D Code.....	DR-5-H-GU10-50/54

These lamps have a different luminosity. Only use lamps of the same type in the cooker hood.

These lamps are available from Miele or from specialist retailers.

- Switch off the fan and the lighting.

 Note that lamps become very hot when in use. They can cause burns even after being switched off for some time. Allow the lamps to cool down for a few minutes before changing them.

- Disconnect the cooker hood from the mains electrical supply (see “Warning and Safety instructions”).
- Remove the grease filters.

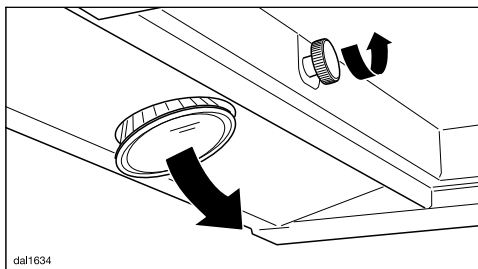

- Turn the nut anti-clockwise as far as it will go. The lamp will then drop down towards you.

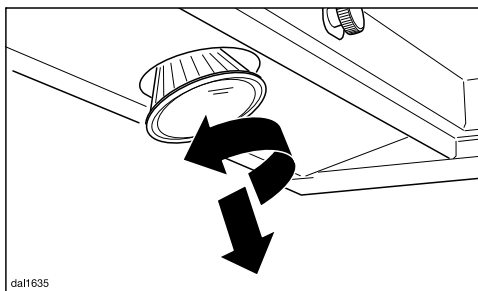

- Turn the lamp anti-clockwise and pull it out.
- Screw the new lamp into the socket and push it upwards. Please follow the manufacturer's safety instructions.

## Contact in the event of a fault

In the event of any faults which you cannot remedy yourself, please contact your Miele dealer or the Miele Customer Service Department.

You can book a Miele Customer Service Department call-out online at [www.miele.com/service](http://www.miele.com/service).

Contact information for the Miele Customer Service Department can be found at the end of this document.

Please quote the model identifier and serial number of your appliance (Fabr./SN/Nr.) when contacting the Miele Customer Service Department. This information can be found on the data plate.

Please note that telephone calls may be monitored and recorded for training purposes and that a call-out charge will be applied to service visits where the problem could have been resolved as described in this booklet.

## Position of the data plate

The data plate is visible after removing the grease filters.

## Warranty

For information on the appliance warranty specific to your country please contact Miele. See back cover for address.

In the UK, your appliance warranty is valid for 2 years from the date of purchase. However, you must activate your cover by calling 0330 160 6640 or registering online at [www.miele.co.uk](http://www.miele.co.uk).

# Installation

## Before installation

 Before installation, it is important to read the information given on the following pages as well as the “Warning and Safety instructions” at the beginning of this booklet.

## Protective foil

The housing components have protective foil around them to protect them from transport damage.

- Please remove this foil before fitting the housing components. It can be peeled off easily.

## Installation materials

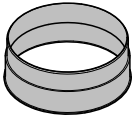

**1 vent connection**  
for exhaust ducting  $\varnothing$  150 mm.

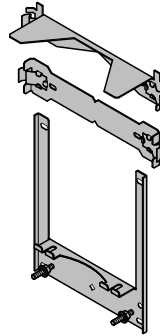

## 3 wall brackets

for securing the cooker hood to the wall.



**8 screws, 5 x 60 mm** and

**8 plugs, 8 x 50 mm**  
for securing to the wall.

 The screws and plugs are designed for use in solid walls only. For other types of wall construction, alternative fixings will be required. Make sure the wall is able to take the weight of the cooker hood.



**2 M6 nuts with locking teeth**  
for securing the appliance.



**2 screws, 3.9 x 7.5 mm**  
for securing the chimney.

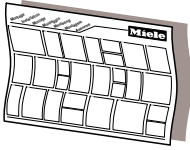

dina3mie

## Installation plan

See the installation plan for details on the individual steps involved in the installation of this appliance.

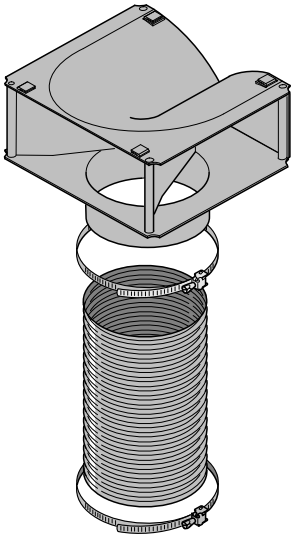

DUW20

## Conversion kit for recirculation mode

The conversion kit contains an exhaust grille, hose and hose clips (not supplied, but available as an optional accessory. See “Technical data”).

# Installation

## Appliance dimensions

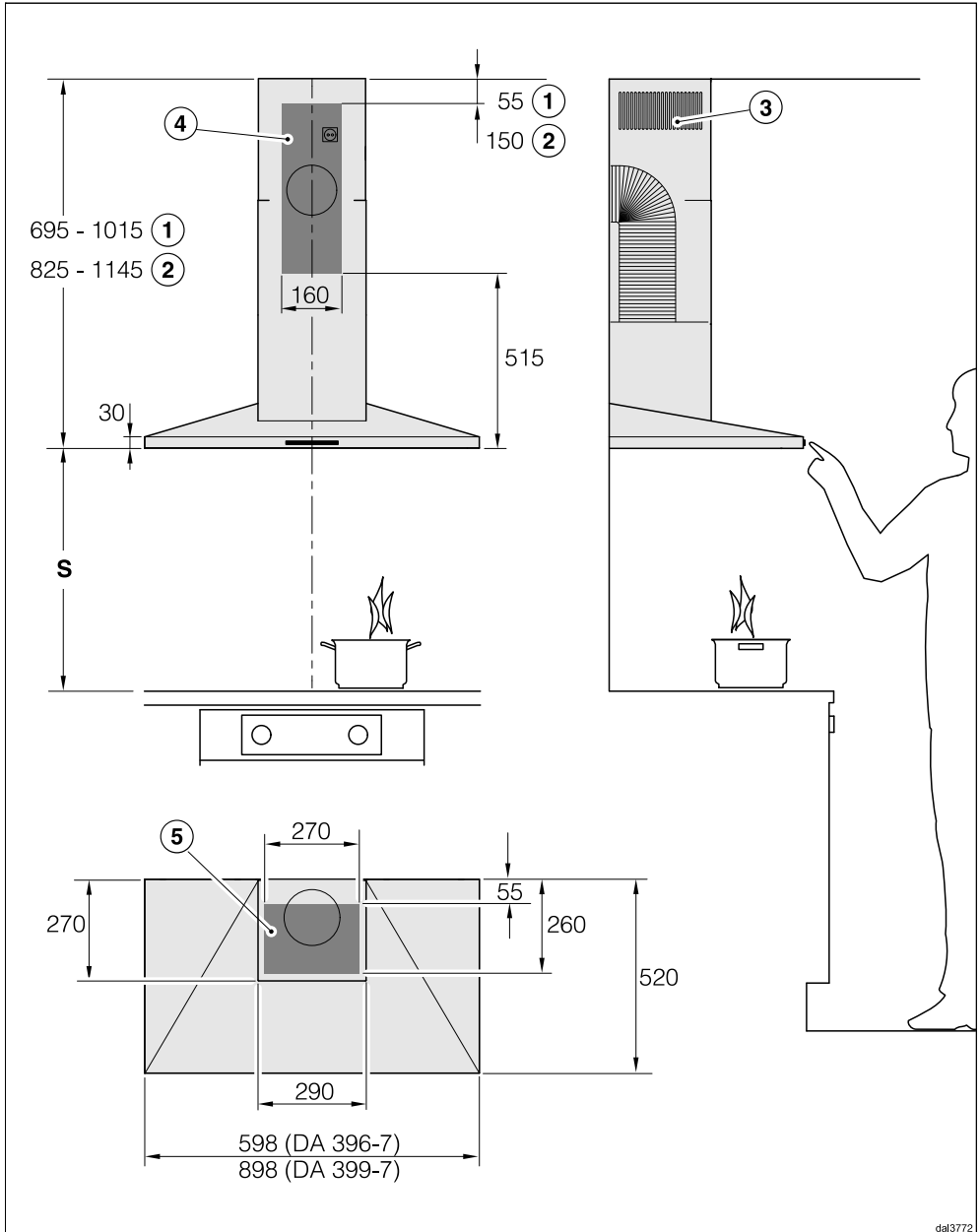

dal3772

The diagram is not drawn to scale.

- ① Extraction
- ② Recirculation
- ③ Ventilation grille positioned at the top for recirculation
- ④⑤ (Only ④ is required for recirculation mode cooker hoods). The shaded area represents the wall or ceiling area for the ducting cut-out and for the connection socket. Recirculation cooker hoods only need a connection socket to be fitted.

Connection for air extraction  $\varnothing$  150 mm

## Safety distance between hob and cooker hood (S)

When planning the installation height of your cooker hood, the minimum safety distance between the top of a cooker or hob and the bottom of the cooker hood is as follows, unless a greater distance is specified by the manufacturer of your cooking appliance.

See “Warning and Safety” instructions for further information.

Cooking appliance	Minimum distance S
Electric hob	450 mm
Electric grill, deep fat fryer (electric)	650 mm
Multi-burner gas hob, total output $\leq$ 12.6 kW, no burner $>$ 4.5 kW	650 mm
Multi-burner gas hob, total output $>$ 12.6 kW and $\leq$ 21.6 kW, no burner $>$ 4.8 kW.	760 mm
Multi-burner gas hob, total output $>$ 21.6 kW, or multi-burner gas hob where one burner $>$ 4.8 kW.	Not possible
Single burner gas hob, output $\leq$ 6 kW.	650 mm
Single burner gas hob, output $>$ 6 kW and $\leq$ 8.1 kW.	760 mm
Single burner gas hob, output $>$ 8.1 kW	Not possible

# Installation

## Installation recommendations

- When deciding on the safety distance between the hob and cooker hood, please note that a distance of 650 mm above electric cookers/hobs may be preferable to give more working space under the hood.
- Account should also be taken of the height of the person who will be using the hood most often. They should have sufficient space to work comfortably at the hob, and be able to reach the cooker hood controls with ease.
- Please be aware that if positioned too high, extraction will be inefficient.
- To achieve optimum vapour extraction, the cooker hood must be positioned centrally over the hob, not to the side.
- The hob should be no wider than the cooker hood, and if possible, it should be narrower.
- The installation area must be easily accessible. The cooker hood should be easily accessible and easy to dismantle in the event that service is required. This should be taken into consideration when planning the position of cupboards, shelves, ceilings or features in the vicinity of the cooker hood.

## Drilling diagram for wall mounting

- Please follow the directions given in the installation instructions supplied for drilling.

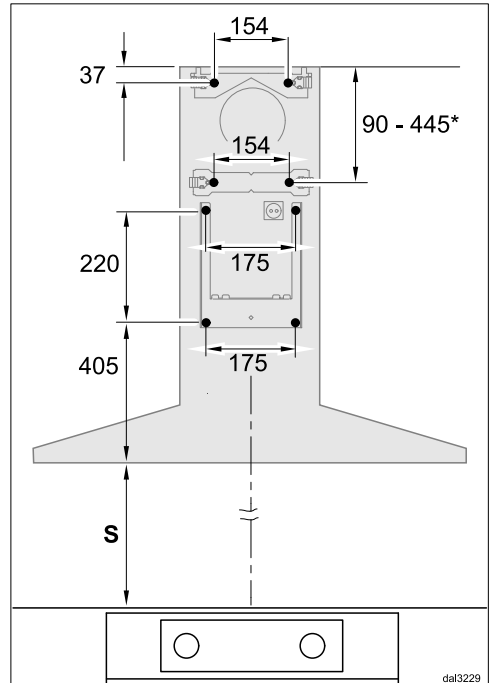

- For pre-installation of a back wall where the holes have to be pre-drilled, please refer to the drilling distances in the drawing above (screws  $\varnothing$  5 mm).

\*The dimension for the middle wall bracket is variable. It will depend on the position of the wall vent and the socket. It should be set as low as possible.

## Connection for air extraction

 If the cooker hood is used at the same time as a heating appliance that relies on oxygen from the same room, there is a risk in certain circumstances of toxic fumes building up.

It is essential that the “Warning and Safety” instructions are observed. The cooker hood should be installed according to local and national building regulations. Seek approval from the building inspector where necessary.

Only use smooth pipes or flexible exhaust ducting made from approved non-flammable materials for exhaust ducting.

To achieve the most efficient air throughput with the lowest noise levels, please note the following:

- The diameter of the exhaust ducting must not be smaller than the cross-section of the exhaust duct (see “Appliance dimensions”). This applies in particular when using flat ducting.
- The exhaust ducting should be as short and straight as possible.
- Only use wide radius bends.
- The exhaust ducting must not be kinked or compressed.
- All connections must be strong and airtight.
- If the exhaust ducting has flaps, these must be opened whenever the cooker hood is switched on.

Any constriction of the air throughput will reduce extraction performance and increase operating noise.

## Flue

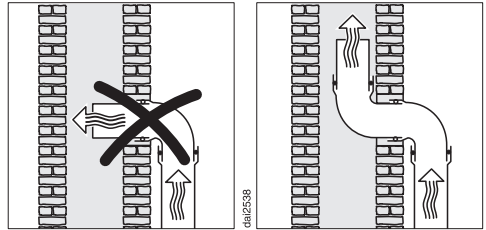

If the exhaust air is to be ducted into a flue, the ducting must be directed in the flow direction of the flue.

If the flue is used by several ventilation units, the cross-section of the flue must be large enough.

## Non-return flap

- Use a non-return flap in the exhaust system.

A non-return flap ensures that when the cooker hood is not in operation, the duct is closed to prevent unwanted exchange of room air and outside air.

If the exhaust is ducted through an outside wall, a Miele wall vent or roof vent (available as an optional accessory) is recommended. Both of these have a built-in non-return flap.

If the on-site ventilation system does not have a non-return flap, you can purchase one as an optional accessory.

## Condensation

If the exhaust ducting is to run through cool rooms or ceiling space, for example, the significant variations in

# Installation

temperature between the different areas can cause condensation to form. Insulate the exhaust ducting to reduce temperature variations.

If the exhaust ducting is to be laid horizontally, it must be laid with a downwards sloping gradient of at least 1 cm per meter. This is to ensure that condensation cannot drain back into the cooker hood.

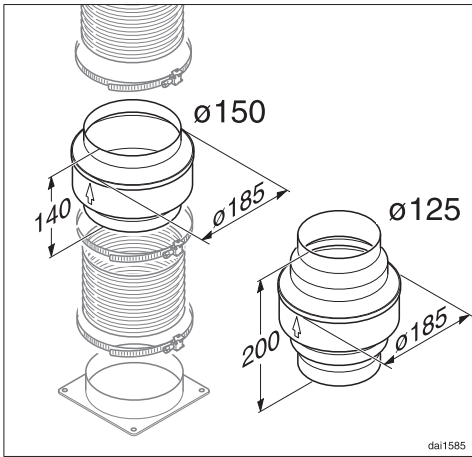

In addition to insulating the exhaust ducting, it is advisable to also install a condensate trap for collecting and evaporating any potential condensation.

Condensate traps for 125 mm or 150 mm diameter exhaust ducting are available as optional accessories.

When installing a condensate trap, ensure that it is positioned vertically and as closely as possible to the cooker hood above the exhaust connection. The arrow on the casing indicates the direction of airflow.

Miele shall not accept warranty claims for any functional defects or damage caused by inadequate exhaust ducting.

## Silencer

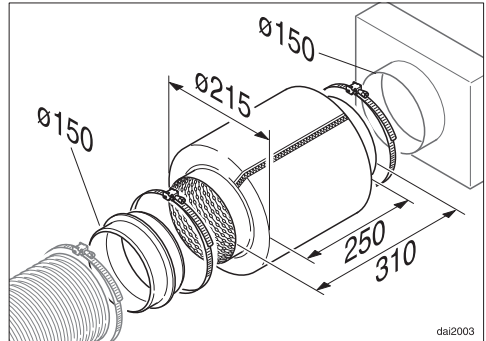

To reduce noise levels even further, a silencer (optional accessory) can be installed in the exhaust ducting.

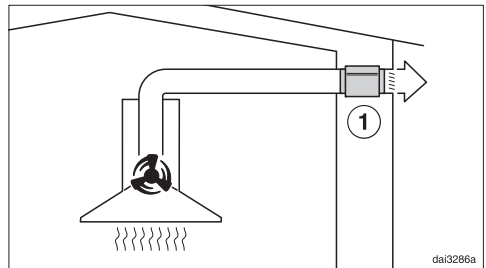

In extraction mode, the silencer not only reduces noise from the fan outside the house, but also sounds originating outside reaching the kitchen through the exhaust ducting (e.g. traffic noise). For this reason, the silencer must be positioned as close as possible to the ducting exit ①.

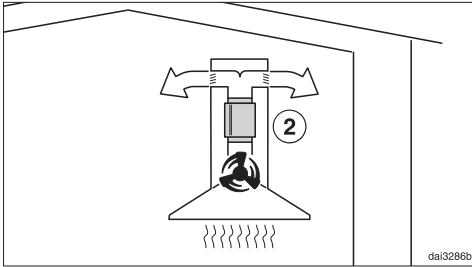

In recirculation mode, the silencer needs to be positioned between the exhaust socket and the directional unit ②. Check that there is sufficient space.

## Electrical connection

Refer to the notes in “Electrical connection” and “Warnings and safety notes” before connecting to the power supply.

The connection data (voltage, frequency) on the data plate must match the data of the mains power supply. The position of the data plate is explained in the “Service” chapter.

The cooker hood is equipped with a power cable and a safety plug.

The connection must be made via a socket which remains accessible after the cooker hood has been installed. If the socket is no longer accessible after installation or if you are using a hard-wired connection, there must be a suitable means of disconnection for all poles in the household electrical system which meets the requirements of overvoltage category III.

Safety can be increased by fitting the appliance with a residual current device.

Only qualified electricians are permitted to carry out work on the household electrical system.

This appliance must be earthed.

## Technical data

---

Fan motor	120 W
Hob lighting	2 x 3 W
Total rated load	126 W
Mains voltage, frequency	AC 230 V, 50 Hz
Fuse rating	3 A
Mains connection cable length	1.5 m
Weight	
DA 396-7	21 kg
DA 399-7	26 kg

### Optional accessories for recirculation mode

DUW 20 kit to convert from extraction mode to recirculation mode and charcoal filter DKF 12-P or DKF 12-R (reactivatable).

## Data sheet for household cooker hoods

In acc. with delegated regulation (EU) No. 65/2014 and regulation (EU) No. 66/2014

<b>MIELE</b>	
<b>Model name / identifier</b>	DA 396-7
Annual Energy Consumption ( $AEC_{hood}$ )	59,1 kWh/year
Energy efficiency class	C
Energy efficiency index ( $EEL_{hood}$ )	75,8
Fluid Dynamic Efficiency ( $FDE_{hood}$ )	17,0
Fluid Dynamic Efficiency class	
A (most efficient) to G (least efficient)	D
Lighting Efficiency ( $LE_{hood}$ )	60,0 lx/W
Lighting Efficiency class	
A (most efficient) to G (least efficient)	A
Grease Filtering Efficiency	95,1 %
Grease Filtering Efficiency class	
A (most efficient) to G (least efficient)	A
Airflow at best efficiency point	316,5 m <sup>3</sup> /h
Air flow (min. speed)	150 m <sup>3</sup> /h
Air flow (max. speed)	350 m <sup>3</sup> /h
Air flow (intensive or boost setting)	500 m <sup>3</sup> /h
Max. air flow ( $Q_{max}$ )	500 m <sup>3</sup> /h
Air pressure at best efficiency point	209 Pa
Airborne acoustical A-weighted sound power emissions (min. speed)	41 dB
Airborne acoustical A-weighted sound power emissions (max. speed)	55 dB
Airborne acoustical A-weighted sound power emissions (intensive or boost setting)	62 dB
Electrical power input at best efficiency point	108,0 W
Power consumption in off mode ( $P_o$ )	W
Power consumption in standby mode ( $P_s$ )	0,20 W
Nominal power of lighting system	6,0 W
Average illumination of the lighting system on the cooking surface	360 lx
Time increase factor	1,4

# Technical data

## Data sheet for household cooker hoods

In acc. with delegated regulation (EU) No. 65/2014 and regulation (EU) No. 66/2014

<b>MIELE</b>	
<b>Model name / identifier</b>	DA 399-7
Annual Energy Consumption (AEC <sub>hood</sub> )	58,9 kWh/year
Energy efficiency class	C
Energy efficiency index (EEI <sub>hood</sub> )	76,1
Fluid Dynamic Efficiency (FDE <sub>hood</sub> )	16,8
Fluid Dynamic Efficiency class	
A (most efficient) to G (least efficient)	D
Lighting Efficiency (LE <sub>hood</sub> )	50,0 lx/W
Lighting Efficiency class	
A (most efficient) to G (least efficient)	A
Grease Filtering Efficiency	95,1 %
Grease Filtering Efficiency class	
A (most efficient) to G (least efficient)	A
Airflow at best efficiency point	291,0 m <sup>3</sup> /h
Air flow (min. speed)	150 m <sup>3</sup> /h
Air flow (max. speed)	350 m <sup>3</sup> /h
Air flow (intensive or boost setting)	500 m <sup>3</sup> /h
Max. air flow (Q <sub>max</sub> )	500 m <sup>3</sup> /h
Air pressure at best efficiency point	222 Pa
Airborne acoustical A-weighted sound power emissions (min. speed)	41 dB
Airborne acoustical A-weighted sound power emissions (max. speed)	55 dB
Airborne acoustical A-weighted sound power emissions (intensive or boost setting)	62 dB
Electrical power input at best efficiency point	107,0 W
Power consumption in off mode (P <sub>o</sub> )	W
Power consumption in standby mode (P <sub>s</sub> )	0,20 W
Nominal power of lighting system	6,0 W
Average illumination of the lighting system on the cooking surface	300 lx
Time increase factor	1,4





## United Kingdom

Miele Co. Ltd., Fairacres, Marcham Road, Abingdon, Oxon, OX14 1TW

Tel: 0330 160 6600, Internet: [www.miele.co.uk/service](http://www.miele.co.uk/service), E-mail: [info@miele.co.uk](mailto:info@miele.co.uk)

### Australia

Miele Australia Pty. Ltd.  
ACN 005 635 398  
ABN 96 005 635 398  
1 Gilbert Park Drive  
Knoxfield, VIC 3180  
Tel: 1300 464 353  
Internet: [www.miele.com.au](http://www.miele.com.au)

### China Mainland

Miele Electrical Appliances Co., Ltd.  
1-3 Floor, No. 82 Shi Men Yi Road  
Jing' an District  
200040 Shanghai, PRC  
Tel: +86 21 6157 3500  
Fax: +86 21 6157 3511  
E-mail: [info@miele.cn](mailto:info@miele.cn)  
Internet: [www.miele.cn](http://www.miele.cn)

### Hong Kong, China

Miele (Hong Kong) Ltd.  
41/F - 4101, Manhattan Place  
23 Wang Tai Road  
Kowloon Bay, Hong Kong  
Tel: (852) 2610 1025  
Fax: (852) 3579 1404  
Email:  
[customerservices@miele.com.hk](mailto:customerservices@miele.com.hk)  
Website: [www.miele.hk](http://www.miele.hk)

### India

Miele India Pvt. Ltd.  
1st Floor, Copia Corporate Suites,  
Commercial Plot 9,  
Mathura Road, Jasola,  
New Delhi - 110025  
E-mail: [customercare@miele.in](mailto:customercare@miele.in)  
Website: [www.miele.in](http://www.miele.in)

### Ireland

Miele Ireland Ltd.  
2024 Bianconi Avenue  
Citywest Business Campus  
Dublin 24  
Tel: (01) 461 07 10  
Fax: (01) 461 07 97  
E-Mail: [info@miele.ie](mailto:info@miele.ie)  
Internet: [www.miele.ie](http://www.miele.ie)

### Malaysia

Miele Sdn Bhd  
Suite 12-2, Level 12  
Menara Sapura Kencana  
Petroleum  
Solaris Dutamas No. 1  
Jalan Dutamas 1  
50480 Kuala Lumpur, Malaysia  
Phone: +603-6209-0288  
Fax: +603-6205-3768

### New Zealand

Miele New Zealand Limited  
IRD 98 463 631  
8 College Hill  
Freemans Bay, Auckland 1011  
New Zealand  
Tel: 0800 464 353  
Internet: [www.miele.co.nz](http://www.miele.co.nz)

### Singapore

Miele Pte. Ltd.  
29 Media Circle  
#11-04 ALICE@Mediapolis  
Singapore 138565  
sTel: +65 6735 1191  
Fax: +65 6735 1161  
E-Mail: [info@miele.com.sg](mailto:info@miele.com.sg)  
Internet: [www.miele.sg](http://www.miele.sg)

### South Africa

Miele (Pty) Ltd.  
63 Peter Place  
Bryanston 2194  
P.O. Box 69434  
Bryanston 2021  
Tel: (011) 875 9000  
Fax: (011) 875 9035  
E-mail: [info@miele.co.za](mailto:info@miele.co.za)  
Internet: [www.miele.co.za](http://www.miele.co.za)

### Thailand

Miele Appliances Ltd.  
BHIRAJ TOWER at EmQuartier  
43rd Floor Unit 4301-4303  
689 Sukhumvit Road  
North Klongton Sub-District  
Vadhana District  
Bangkok 10110, Thailand

### United Arab Emirates

Miele Appliances Ltd.  
Showroom 1  
Eiffel 1 Building  
Sheikh Zayed Road, Umm Al Sheif  
P.O. Box 114782 - Dubai  
Tel. +971 4 3044 999  
Fax. +971 4 3418 852  
800-MIELE (64353)  
E-Mail: [info@miele.ae](mailto:info@miele.ae)  
Website: [www.miele.ae](http://www.miele.ae)

**Manufacturer:** Miele & Cie. KG, Carl-Miele-Straße 29, 33332 Gütersloh, Germany

DA 396-7, DA 399-7

en-GB

M.-Nr. 11 743 090 / 00