

RV ROOFTOP INVERTER HEAT PUMP AIR CONDITIONER

# PIONEER®

MODEL NO: PYZ012AZUDCIPD

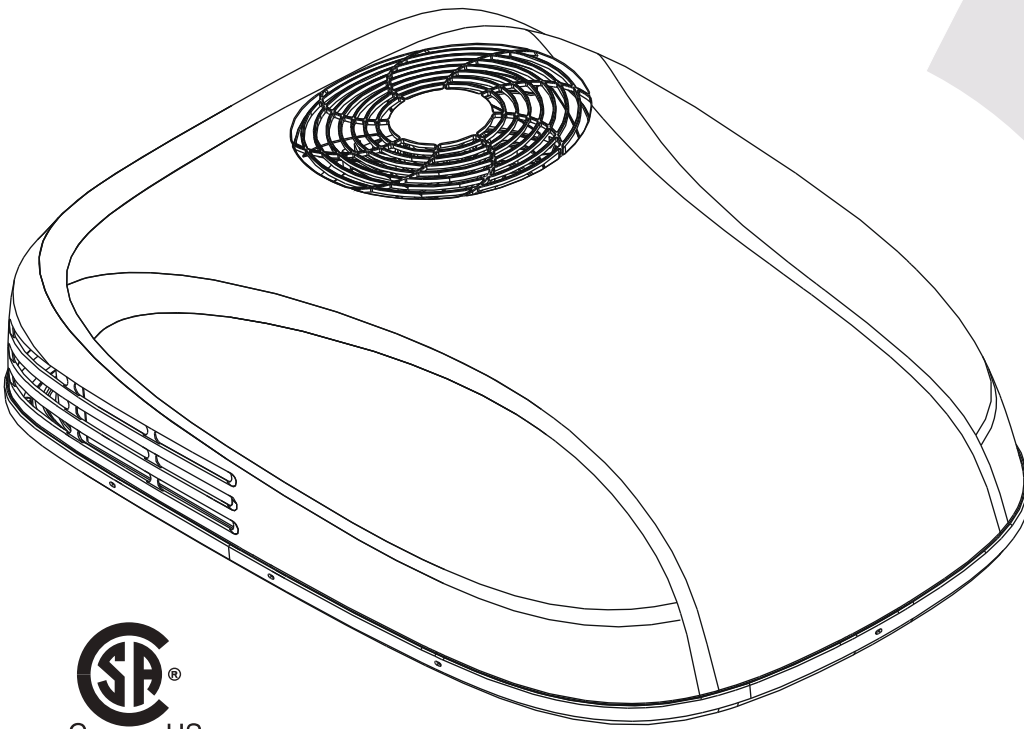

## Owner's Manual

- Installation
- Operation
- Maintenance

### IMPORTANT NOTICE:

Please read this manual carefully before installing or operating your new air conditioning system. Be sure to save this manual for future reference.



REV112124

# INSTRUCTIONAL HANDBOOK

## Table of Contents

### **I. Operational Instructions.....1**

1. Safety Information.....	1
2. Scope and Purpose of This Manual.....	2
3. Model Number and Technical Details Identification.....	2
4. Handling Procedures.....	3
5. Usage Information.....	9
6. Best Practices for Optimal Performance.....	10
7. Warnings and Safety Precautions for A2L Refrigerant.....	10
8. Description of the Controls.....	11
9. Automatic Mode Operation.....	12
10. Cooling Mode Operation.....	12
11. Dehumidification Mode Operation.....	13
12. Ventilation Mode Operation.....	13
13. Heat Pump Mode Operation.....	14
14. Night Mode Operation.....	14
15. Timer On and Timer Off Mode Operation.....	15
16. Handling of the Remote Controller.....	16
17. Description of the Decorative Panel.....	16
18. Wi-Fi Connection and Instructions for Usage.....	17
19. Routine Maintenance.....	18

### **II. Installation Instructions.....19**

1. Getting Started.....	19
2. Installation Positioning.....	19
3. Guidelines for a Successful Installation.....	20
4. Dimensional Information.....	20
5. Creation of Roof Opening.....	21
6. Electrical Setup.....	22
7. Opening Treatment.....	22
8. Placement of Air Conditioner Onto Roof.....	23
9. Interior Mounting and Connections.....	24
10. Installation of Air Duct Foam.....	25
11. Electrical Wiring.....	26
12. System Connections.....	27
13. Mounting the Panel.....	28
14. Initialization of System.....	29

### **III. DIAGNOSTICS , TECHNICAL CHARACTERISTICS , RECYCLING.....30**

1. Troubleshooting.....	30
2. Error Code Interpretation.....	30
3. Technical System Information.....	31
4. European Disposal Guidelines.....	33

# OPERATIONAL INSTRUCTIONS

## Safety Information

### **⚠ CAUTION - Read Before You Proceed**

#### ***Read and Understand All Safety Precautions Prior to Installation***

For safe operation, it is imperative that the following rules are obeyed:

- This appliance can only be used by children aged 8 years and above, or by persons with reduced physical, sensory, or mental capabilities, or persons with lack of experience and knowledge, if they have been given supervision or instructions concerning usage of the appliance in a safe way and understand the potential hazards involved.
- Children shall not play with this appliance. Proper cleaning and user maintenance shall not be done by children without supervision.
- This appliance should only be installed by those whom are qualified and sufficiently trained to do so, following the instructions herein.
- Modification of this product is an extremely dangerous operation, and may lead to personal injury or loss of property.

### **Electrical Danger**

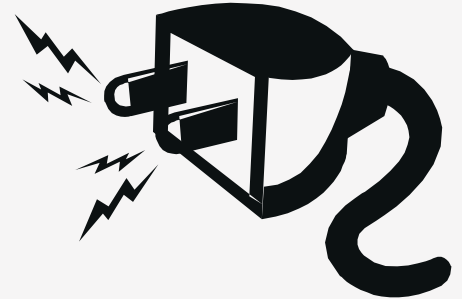

***Failure to abide by the manufacturer cautions can result in property damage, personal injury and/or death.***

### **⚠ WARNING - The Manufacturer Is Not Liable For the Following:**

- Units that have sustained damage due to improper installation or have been connected with an incorrect voltage. Abide by the installation instructions fully and completely to prevent unexpected malfunctions.
- Products that have had extra modifications, where written consent was not provided by the manufacturer.
- Product usage in a way that is not the intended purpose as described in this operational instruction manual.
- Any sort of collateral damage to property or injuring to nearby persons caused by failure of the product.
- Improperly grounded products. The product must be properly grounded at the time of installation, else electrical shock may occur.
- Incorrect configuration of drainage. Install drainage channels according to the instructions in this manual. Improper drainage may cause water damage to your vehicle and property.

### **🔧 Note about Fluorinated Gasses and Operation of the System**

1. This air-conditioning unit contains fluorinated gasses. For specific information on the type of gas and the amount, please refer to the relevant label on the unit itself. Some refrigerants may not exude an odor.
2. Installation, service, maintenance, and repair of this unit must be performed by a certified HVAC technician, or qualified personnel familiar with the risks of handling refrigerant and regulations of air conditioner systems.
3. Product uninstallation and recycling must be performed by a certified HVAC technician.
4. Do not use the system near combustible objects or flammable fluids. Keep a distance of at least 2 feet from other nearby appliances. If a fire occurs, a proper extinguishing agent, rather than water, must be used.
5. When the unit is being checked for leaks, proper logging and record-keeping of all checks by certified personnel is strongly recommended. Refrigerant must never be released into the air, a proper recovery device should be used.
6. The system and/or its internal moving parts should not be touched, poked, or prodded during operation.



# OPERATIONAL INSTRUCTIONS

## Scope and Purpose of This Manual

This manual has been specifically compiled by the manufacturer and is an essential component of the machine. The information contained within can guarantee proper usage of the machine, if observed and followed carefully.

Sections **I** and **III** are intended to provide helpful instructions and knowledge to the end user. Section **II** is intended to instruct the installer, who should be a person that possesses expert knowledge and experience in this field of work.

Where applicable, some portions of text may be accompanied by certain symbols, that of which can be understood by referencing the below table:

-  This symbol indicates a potential source of danger.
-  This symbol indicates useful information or a helpful tip.
-  This symbol indicates information on being environmentally friendly.

## Model Number and Technical Details Identification

### Interpreting the Rating Label:



**Technical Specifications**

**Model Number**



Model: PYZ012AZUDCIPD

**PIONEER**

**13.5K RV ROOF AIR CONDITIONER(Inverter)**

<p><b>Power:</b> 115V~/60Hz/1Ph</p> <p><b>Cooling Capacity (Btu/h):</b> 7,500-13,500</p> <p><b>Heating Capacity (Btu/h):</b> 7,200-13,500</p> <p><b>Indoor Fan Motor:</b> 1/16 HP FLA - 0.8A</p> <p><b>Outdoor Fan Motor:</b> 1/4 HP FLA - 1.0A</p> <p><b>Global Warming Potential:</b> 675</p> <p><b>Refrigerant R32:</b> 560g/19.75 oz</p> <p>PARKER DAVIS HVAC INTERNATIONAL Miami, FL - www.pdhvac.com - (800)-675-7410</p>	<p><b>Rated Input Current of the Power Conversion Equipment:</b> 11A</p> <p>MIN. CIR. AMPS 16 AMPS</p> <p>MAX. CIR. PROTECTION 25 AMPS</p> <p><b>Maximum allowable Pressure(High Side):</b> 6.0MPa/870PSIG</p> <p><b>Degree of Protection (Outside IP):</b> IPX4</p>
---	--

**Supplier Information**



MADE IN CHINA  
Date of Manufacture: See barcode

*Product details may vary and can change at any time, consult physical namebadge for best accuracy.*

# OPERATIONAL INSTRUCTIONS

## Handling Procedures

### PRELIMINARY PRECAUTIONS



- Do not use any methods other than those recommended by the manufacturer to accelerate the defrosting process or to clean the appliance.
- The appliance must be stored in a room free from continuously operating open flames, ignition sources (e.g., an operating gas appliance or electric heater), or other sources of ignition.
- Ensure that the appliance is stored in a way that prevents mechanical damage.
- Do not pierce or burn the appliance.
- Be aware that refrigerants used in this appliance may not have an odor, so leaks may not be immediately detectable.
- Store the appliance in a well-ventilated area, ensuring the room size meets the minimum area requirements specified for safe operation.
- Compliance with national gas regulations must be observed. The minimum applicable area for this machine is 160 ft<sup>2</sup>. Ensure that there are no obstacles in front of the machine and keep ventilation openings clear of any obstructions.
- Servicing should only be carried out as recommended by the manufacturer.
- Any person working on or accessing the refrigerant circuit must hold a valid certificate from an industry-accredited authority, confirming their competence to handle refrigerants safely according to recognized industry standards.
- Maintenance and repairs requiring additional skilled personnel should be conducted under the supervision of a person qualified in the safe handling of flammable refrigerants.

*Before starting work on systems containing flammable refrigerants, safety checks must be conducted to minimize the risk of ignition. When repairing the refrigeration system, the following precautions must be observed before beginning work:*

### **Work Procedure**

All work should be carried out under controlled conditions to minimize the risk of flammable gases or vapors being present while the work is in progress.

### **General Work Area**

- All maintenance personnel and others in the vicinity must be informed of the nature of the work being conducted.
- Avoid working in confined spaces whenever possible.
- Section off the area around the workspace to restrict access.
- Ensure that the area is safe by controlling any flammable materials present.

### **No Ignition Sources**

Anyone working on a refrigeration system that involves exposing any pipework containing or that has contained flammable refrigerant must ensure that no ignition sources are used in a way that could lead to a fire or explosion. All potential sources of ignition, including cigarette smoking, must be kept at a safe distance from the site of installation, repair, removal, or disposal, where flammable refrigerant could be released into the surrounding area.

Before beginning work, inspect the area around the equipment to ensure there are no flammable hazards or ignition risks. Ensure the area is either outdoors or well-ventilated before breaking into the system or performing any hot work. Ventilation should be maintained throughout the work to safely disperse any released refrigerant, preferably directing it safely to the outside atmosphere.

# OPERATIONAL INSTRUCTIONS

## Handling Procedures

### PRELIMINARY PRECAUTIONS (CONT'D)

#### Checks for Refrigeration Equipment

When replacing electrical components, ensure they are suitable for the intended purpose and meet the correct specifications. Always follow the manufacturer's maintenance and service guidelines. For any uncertainty, consult the manufacturer's technical support for assistance.

The following checks must be performed on installations using flammable refrigerants:

**Refrigerant Charge Size:** Ensure that the charge size is appropriate for the room size where refrigerant-containing parts are installed.

**Ventilation:** Verify that ventilation equipment and outlets are functioning properly and are unobstructed.

**Indirect Refrigeration Circuit:** If using an indirect refrigeration circuit, inspect the secondary circuit to confirm the absence of refrigerant.

**Equipment Markings:** Ensure that all markings on the equipment remain visible and legible. Replace any illegible markings or signs.

**Corrosion Prevention:** Confirm that refrigeration pipes or components are installed in a location where they are unlikely to be exposed to substances that could corrode refrigerant-containing parts. If exposure is possible, ensure the components are made from materials resistant to corrosion or are adequately protected.

#### Checking for Presence of Refrigerant

- Before and during work, use an appropriate refrigerant detector to check the area for potentially flammable atmospheres.
- Ensure that the leak detection equipment is suitable for flammable refrigerants (i.e., non-sparking, adequately sealed, or intrinsically safe).
- Presence of Fire Extinguisher
- If any hot work is required on the refrigeration equipment or related parts, have suitable fire extinguishing equipment readily available.
- A dry powder or CO<sub>2</sub> fire extinguisher should be placed near the charging area.

#### Checks for Electrical Devices

Repair and maintenance of electrical components must include initial safety checks and thorough inspection procedures. If a fault is identified that could compromise safety, the electrical supply should not be connected until the issue is resolved. If the fault cannot be immediately corrected but operation must continue, a suitable temporary solution may be applied. This should be communicated to the equipment owner to ensure all parties are informed.



Initial safety checks should include:

- Ensuring capacitors are safely discharged to prevent any risk of sparking.
- Verifying that no live electrical components or wiring are exposed while charging, recovering, or purging the system.
- Confirming continuity of earth bonding.

# OPERATIONAL INSTRUCTIONS

## Handling Procedures

### MAINTENANCE, SERVICING, & REPAIRS

#### Repairs to Sealed Components

When repairing sealed components, disconnect all electrical supplies from the equipment before removing any sealed covers or similar parts. If it is absolutely necessary to have an electrical supply during servicing, a continuously operating leak detection device should be positioned at the most critical point to provide early warning of a potentially hazardous situation.

Take particular care to ensure that repairs do not compromise the protective casing of electrical components. This includes avoiding:

- Damage to cables,
- Excessive or improper connections,
- Use of terminals that don't meet original specifications,
- Damage to seals, or
- Incorrect fitting of cable glands.

Ensure that all components are securely mounted, and that seals or sealing materials have not degraded to the point where they no longer prevent the ingress of flammable atmospheres. Replacement parts should be consistent with the original specifications.

**Note:** *Be aware that using silicone sealant may impair the effectiveness of certain types of leak detection equipment.*

**Exception:** *Intrinsically safe components do not need to be isolated before working on them.*

#### Repair of Intrinsically Safe Components

Do not apply any permanent inductive or capacitive loads to the circuit without verifying that they do not exceed the permissible voltage and current limits for the equipment in use. Intrinsically safe components are the only types that may be worked on while live in the presence of a flammable atmosphere. Ensure that the test apparatus is correctly rated for the task.

**Replace components only with parts specified by the manufacturer, as using non-specified parts may lead to ignition of refrigerant from a potential leak.**

#### Cabling

Ensure that cabling is protected from potential wear, corrosion, excessive pressure, vibration, sharp edges, or any other adverse environmental effects. Consider the impact of aging and constant vibration from components like compressors or fans when assessing cable durability.

#### Detection of Flammable Refrigerants

Under no circumstances should potential sources of ignition be used to search for or detect refrigerant leaks. Do not use a halide torch or any other detector that involves an open flame.

# OPERATIONAL INSTRUCTIONS

## Handling Procedures

### MAINTENANCE, SERVICING, & REPAIRS (CONT'D)

#### Leak Detection Methods

The following methods are acceptable for detecting leaks in systems containing flammable refrigerants:

**Electronic Leak Detectors:** Use electronic detectors to identify flammable refrigerants; however, ensure that the sensitivity is sufficient and recalibrate as necessary. Calibration should be performed in a refrigerant-free area. Confirm that the detector is not a potential ignition source and is compatible with the refrigerant in use.

**Calibration Settings:** Set the leak detection equipment to a percentage of the refrigerant's Lower Flammability Limit (LFL) and calibrate it to the specific refrigerant being used. Verify that the gas concentration does not exceed 25% of the LFL.

**Leak Detection Fluids:** Most refrigerants are compatible with leak detection fluids, but avoid detergents containing chlorine, as chlorine can react with the refrigerant and corrode copper piping.

**Safety Precautions:** If a leak is suspected, extinguish all open flames in the area.

**Brazing Leaks:** If a refrigerant leak requiring brazing is detected, recover all refrigerant from the system or isolate it in a section of the system away from the leak using shut-off valves. Purge the system with oxygen-free nitrogen (OFN) before and during the brazing process.

#### Removal and Evacuation

When accessing the refrigerant circuit for repairs or other purposes, use conventional procedures, but adhere to best practices due to flammability considerations. The following steps should be followed:

**Remove the Refrigerant:** Recover the refrigerant into appropriate recovery cylinders.

**Purge with Inert Gas:** Purge the circuit with an inert gas such as oxygen-free nitrogen (OFN).

**Evacuate the System:** Evacuate the system to remove any remaining gases.

**Purge Again:** Perform a second purge with inert gas.

**Open the Circuit:** Open the circuit by cutting or brazing as needed.

The system should be "flushed" with OFN to ensure it is safe. This flushing process may need to be repeated several times. Do not use compressed air or oxygen for this purpose.

To flush the system, break the vacuum with OFN until the working pressure is reached, vent to the atmosphere, then pull down to a vacuum. Repeat this process until no refrigerant remains in the system. When applying the final OFN charge, vent the system down to atmospheric pressure to allow for safe work, especially if brazing operations are required on the pipework.

Ensure the outlet of the vacuum pump is kept away from any ignition sources and that the area is well-ventilated.

# OPERATIONAL INSTRUCTIONS

## Handling Procedures

### MAINTENANCE, SERVICING, & REPAIRS (CONT'D)

#### Charging Procedures

In addition to standard charging procedures, observe the following requirements:

**Prevent Contamination:** Take care to prevent cross-contamination of different refrigerants when using charging equipment. Hoses or lines should be kept as short as possible to minimize the refrigerant volume they contain.

**Cylinder Position:** Always keep cylinders upright.

**Earthing:** Ensure the refrigeration system is properly grounded before charging it with refrigerant.

**Labeling:** Label the system once charging is complete, if it hasn't already been labeled.

**Avoid Overfilling:** Take extreme care not to overfill the refrigeration system.

Before recharging, perform a pressure test on the system with oxygen-free nitrogen (OFN). After charging, but before commissioning, conduct a leak test. A follow-up leak test should be performed before leaving the site.

#### Decommissioning

Before starting the decommissioning process, the technician must be thoroughly familiar with the equipment and all its details. It is recommended to safely recover all refrigerants. Prior to beginning the task, collect an oil and refrigerant sample in case analysis is needed before reusing reclaimed refrigerant. Ensure that electrical power is available before starting.

#### Preparation:

- Review equipment and its operation to ensure familiarity.
- Electrically isolate the system.

Verify the following before beginning:

- **Mechanical Handling:** Mechanical handling equipment is available if needed for refrigerant cylinders.
- **Personal Protective Equipment (PPE):** All necessary PPE is available and used correctly.
- **Supervision:** The recovery process is monitored at all times by a qualified person.
- **Standards Compliance:** Ensure recovery equipment and cylinders meet appropriate standards.

#### Recovery Process:

- Pump down the refrigerant system, if possible.
- If a vacuum cannot be achieved, set up a manifold to remove refrigerant from different parts of the system. Place the recovery cylinder on a scale before starting recovery.

#### Operation:

- Start the recovery machine and follow the manufacturer's instructions.
- Avoid overfilling cylinders; limit the liquid charge to no more than 80% of the cylinder's volume.
- Do not exceed the cylinder's maximum working pressure, even temporarily.

# OPERATIONAL INSTRUCTIONS

## Handling Procedures

### MAINTENANCE, SERVICING, & REPAIRS (CONT'D)

#### **Completion:**

- Once cylinders are filled correctly and the recovery process is complete, remove the cylinders and equipment from the site promptly.
- Close all isolation valves on the equipment.
- Recovered refrigerant must not be charged into another refrigeration system unless it has been properly cleaned and inspected.

#### **Recovery**

When removing refrigerant from a system for servicing or decommissioning, it is best practice to ensure that all refrigerants are safely removed. When transferring refrigerant to cylinders, only use appropriate refrigerant recovery cylinders. Ensure that the correct number of cylinders is available to hold the total system charge. All cylinders used must be designated and clearly labeled for the specific refrigerant being recovered. They should also be equipped with pressure relief valves and functional shut-off valves. Empty recovery cylinders should be evacuated and, if possible, cooled prior to use.

The recovery equipment must be in good working condition, suitable for use with flammable refrigerants, and accompanied by operating instructions. Additionally, calibrated weighing scales should be available and in proper working order. All hoses should have leak-free disconnect couplings and be in good condition. Before using the recovery machine, verify that it is in proper working condition, well-maintained, and that all electrical components are sealed to prevent ignition in the event of a refrigerant leak. Consult the manufacturer if there is any doubt.

Recovered refrigerant should be returned to the refrigerant supplier using the appropriate recovery cylinder, and a relevant Waste Transfer Note must be arranged. Do not mix refrigerants in recovery units or cylinders.

If compressors or compressor oils need to be removed, ensure they are evacuated to a safe level to prevent residual flammable refrigerant from remaining in the lubricant. This evacuation must be done before returning the compressor to the supplier. To speed up the process, only use electric heating to warm the compressor body. Oil drained from the system must be handled safely.

### INSTALLATION ENVIRONMENT OF THE AIR CONDITIONER

The air conditioner can be installed either during the production phase of the RV or after its completion. It must be installed horizontally on the top of the RV.

- The minimum spacing between rafters and joists on the roof structure should be **15-3/4 inches**.
- The roof thickness of the RV must be at least **1 inch** and no more than **4 inches**.
- If the roof thickness exceeds **4 inches**, an additional air duct connection is required.

#### **Intended Purpose of the Air Conditioner**

This air conditioner is designed specifically for RVs to enhance internal temperature control and create a comfortable environment. It provides cooling during hot weather and heating during cold weather, along with adjustable temperature settings for both conditions.

# OPERATIONAL INSTRUCTIONS

## Usage Information

### OPERATIONAL CHARACTERISTICS

The performance of the air conditioner is influenced by the insulation properties of the RV itself. Users can take preventive measures to minimize heat entry, thereby enhancing the cooling efficiency of the air conditioning system.

When the outdoor temperature is high, consider the following steps to reduce heat penetration into the RV and improve system performance:

- Park the RV in a shaded or cool area.
- Enhance the thermal insulation of the compartment, block openings in the vehicle, and use shade curtains, shutters, or hanging curtains over windows.
- Keep doors and windows closed and limit their opening and closing as much as possible.
- Avoid using heat-generating devices inside the vehicle.
- Turn on the air conditioner in advance for optimal cooling performance.

When indoor or outdoor temperatures are high, setting the air conditioner to cooling mode and using the high fan speed setting can maximize its performance.

**Note:** Due to significant changes in air temperature within the vehicle, rapid cooling may cause some condensation to form on surfaces near the air outlet. This is a normal occurrence. As the air conditioner operates for a longer period, the condensate will typically dry out and detach from surfaces. To reduce condensation, keep doors and windows closed as much as possible while the air conditioner is in use. The manufacturer is not liable for any damage resulting from condensation on the ceiling or other surfaces due to the air conditioner's operation.

### Technical Specifications of the Heat Pump

Description	Unit	Value
Model Number	-	PYZ012AZUDCIPD
Rated Cooling Capacity (Range)	BTU/hr	7500 ~ 13500
Rated Heating Capacity (Range)	BTU/hr	7200 ~ 13500
Power Supply / Frequency	V / Hz	115 / 60
FLA of Fan Motor (Indoor)	A	0.8
FLA of Fan Motor (Outdoor)	A	1.0
MCA	A	16
MOP	A	25
Rated Input Current of the Converter	A	11
Refrigerant Type	-	R32
Refrigerant Amount	oz.	19.75
Cable Standard	AWG / ft.	12 / <25
Circuit Protection Fuse	A	20
Cooling Mode Operational Temperatures	°F	63 ~ 109 (Outdoor) / 63 ~ 90 (Indoor)
Heating Mode Operational Temperatures	°F	28 ~ 75 (Outdoor) / 28 ~ 81 (Indoor)



### Note:

- Please use connecting wires that comply with national regulations.
- When selecting a generator, consider the total power consumption of the RV.
- Generators may experience power loss at high altitudes or due to insufficient maintenance.
- Circuit Protection: Always use a leakage circuit breaker for safety.





# OPERATIONAL INSTRUCTIONS

## Best Practices for Optimal Performance

 *For best results, the following tips are given in order to improve the output and efficiency of the machine:*

-  Increase the vehicle's insulation amount by sealing off openings and covering glass surfaces with reflective or blackout curtains.
-  When running the machine, select the desired temperature and fan speed and ensure that the air vents are oriented in a suitable and proper direction.
-  Avoid the frequent opening of doors and/or windows when not necessary.

 *To prevent mechanical malfunctions and minimize risk of personal injury, ensure that the following precautions are abided by:*

-  Avoid obstruction of the ventiled air inlet. Do not cover with cloth, paper, etc.
-  Do not put hands or insert fingers into any of the machine's openings.
-  Do not spray water into or onto the surface of the machine.
-  Keep flammable substances and objects 3 feet or more away from the machine.
-  Clean the machine's air filters periodically.

## Warnings and Safety Precautions for A2L Refrigerant



This appliance uses A2L refrigerant, which is classified as mildly flammable. It is critical to follow these safety precautions to minimize the risk of fire or explosion.

### Handling and Installation:

- Only qualified personnel should handle A2L refrigerant. Improper handling can cause injury or damage.
- Before servicing, check for ignition sources and ensure proper ventilation. Use a suitable leak detector to confirm the area is safe.
- Ensure all electrical components are rated for A2L refrigerant and avoid any sources of ignition during installation or service.
- When charging the system, ensure proper grounding and secure connections. Avoid overfilling the system.

### Leak Detection and Repair:

- If a leak is suspected, do not use open flames or spark-generating tools. Use appropriate electronic leak detectors.
- Evacuate and ventilate the area immediately if a leak is found. Repair leaks only when the area is safe.
- Keep a fire extinguisher rated for flammable materials nearby when working with A2L refrigerants.

### Decommissioning and Disposal:

- Recover all refrigerant and purge the system with inert gas before disassembly.
- Dispose of refrigerant according to regulations and do not vent it into the atmosphere.
- Clearly label equipment containing A2L refrigerant and ensure all safety information is visible.

Adhering to these guidelines ensures safe handling and use of A2L refrigerant, preventing injury, damage, or environmental harm.

# OPERATIONAL INSTRUCTIONS

## Description of the Controls

### 📍 Selecting the Functional Mode:

Press the **MODE** button to cycle between the available states on the machine. After two seconds have elapsed, the system will confirm the selection with an audible beep from the machine's speaker. Always point the remote controller toward the control panel when sending commands to ensure the best reception.

**NOTE:** When first switching on the system, the machine will stay in standby mode for a few minutes before the compressor begins operating.

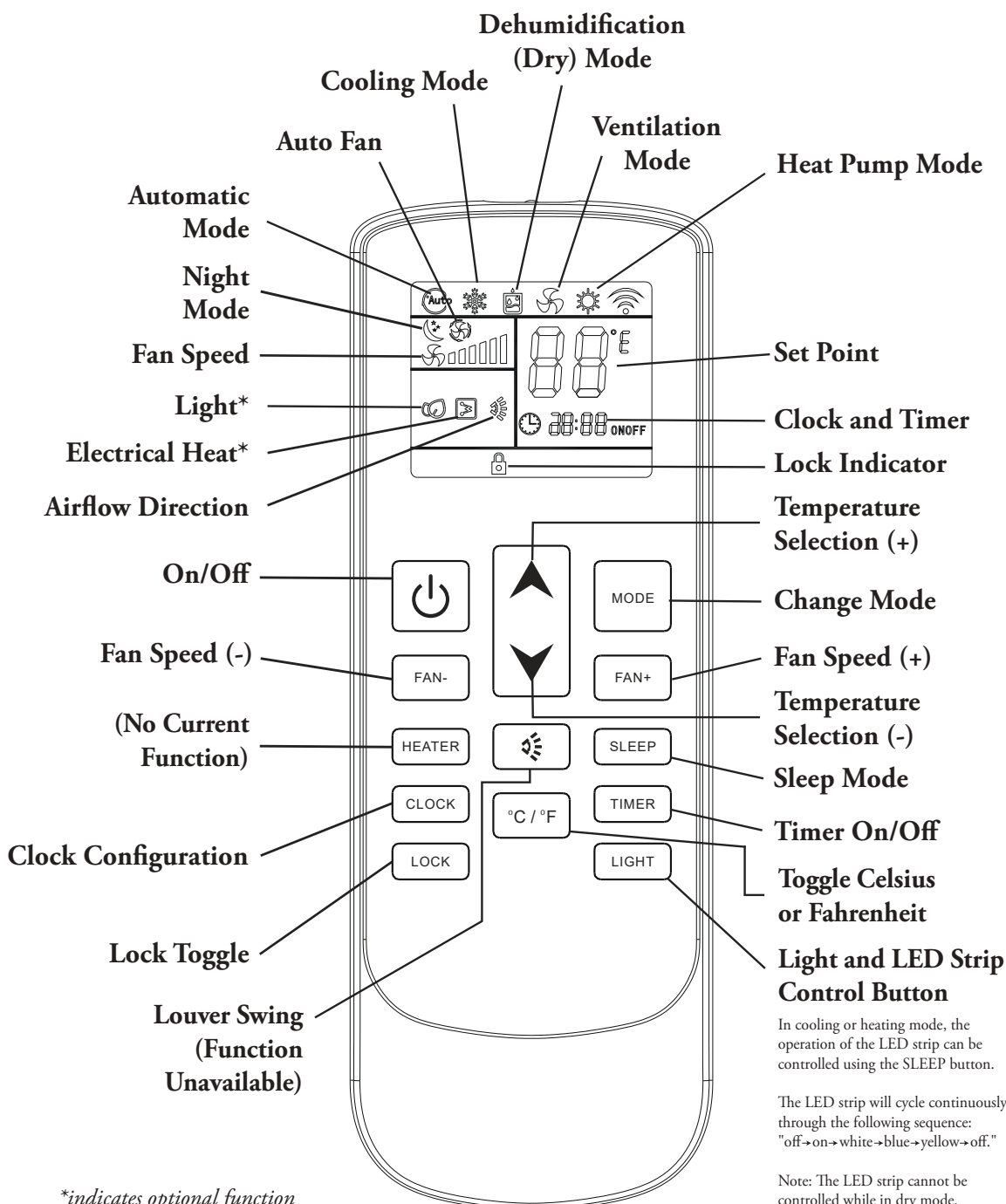





# OPERATIONAL INSTRUCTIONS

## Automatic Mode Operation

In **AUTO** mode, the system manages the compressor, heat pump, and fan speeds entirely autonomously by comparing the set temperature with the current internal temperature to determine whether to output heating or cooling.

On the **AUTO** speed setting the ventilation speed is set according to the difference in temperature between the set point and the current ambient temperature.

### Automatic Mode Button Control:

	Press the On/Off button to switch the machine on or off
	Press the Change Mode button to select <b>AUTO</b> mode
	Use the temperature selection buttons to select the desired set point temperature.
	Press the fan speed buttons to select low, medium, high, or automatic fan speed

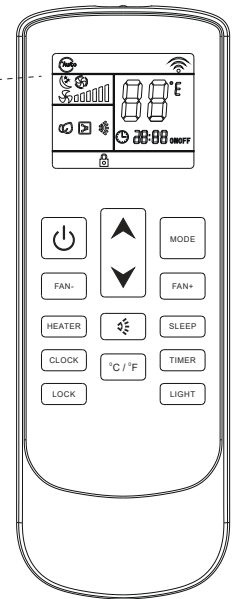
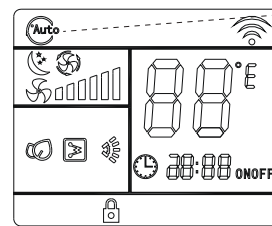





*Note: Auto Fan speed is determined by the difference between set and room temperature.*

 The selected configuration will be retained in the system's memory when it is switched on again next.

## Cooling Mode Operation

### Cooling Mode Button Control:

This mode cools the room air it draws in and supplies it back into the vehicle.

	Press the On/Off button to switch the machine on or off
	Press the Change Mode button to select <b>COOL</b> mode
	Use the temperature selection buttons to select the desired set point temperature.
	Press the fan speed button to select low, medium, high, or automatic fan speed

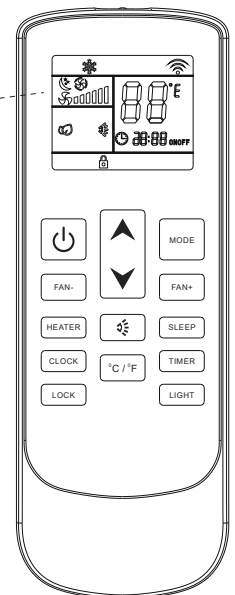
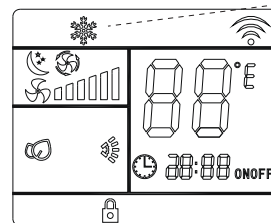

*Note: Auto Fan speed is determined by the difference between set and room temperature.*





 The selected configuration will be retained in the system's memory when it is switched on again next.

# OPERATIONAL INSTRUCTIONS

## Dehumidification Mode Operation

### Dehumidification Mode Button Control:

Dehumidification mode is a limited function that can help reduce the humidity/moisture of the room. However, this system is not intended for use as a dedicated dehumidifier and so this mode should not be left running for very long periods of time.

	Press the On/Off button to switch the machine on or off
	Press the Change Mode button to select <b>DEHUMIDIFICATION</b> mode
	Use the temperature selection buttons to select the desired set point temperature.
	Fan speed selection button is disabled in this mode and will remain low speed.

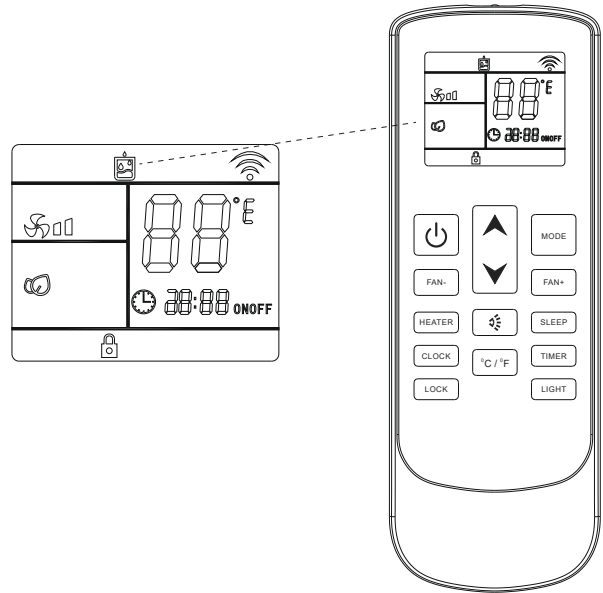





*The selected configuration will be retained in the system's memory when it is switched on again next.*

## Ventilation Mode Operation

### Ventilation Mode Button Control:

Fan-only mode is used to set the system to use only air ventilation and no heating or cooling.

	Press the On/Off button to switch the machine on or off
	Press the Change Mode button to select <b>VENTILATION</b> mode
	Use the temperature selection buttons to select the desired set point temperature.
	Press the fan speed button to select low, medium, high, or automatic fan speed

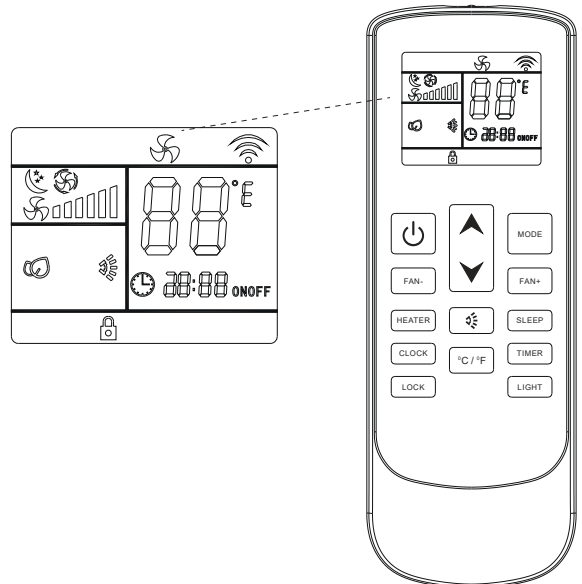





*The selected configuration will be retained in the system's memory when it is switched on again next.*

# OPERATIONAL INSTRUCTIONS

## Heat Pump Mode

### ⓘ Heating Mode Button Control:

This mode heats the room air it draws in and supplies it back into the vehicle.

	Press the On/Off button to switch the machine on or off
	Press the Change Mode button to select <b>HEAT PUMP</b> mode
	Use the temperature selection buttons to select the desired set point temperature.
	Press the fan speed button to select low, medium, high, or automatic speed

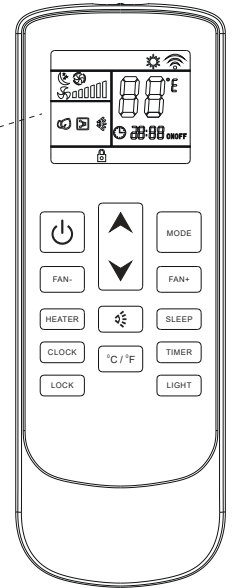
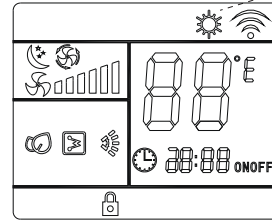





*Note: Auto Fan speed is determined by the difference between set and room temperature.*

☞ *The selected configuration will be retained in the system's memory when it is switched on again next.*

## Night Mode Operation

### ⓘ Night Mode Button Control:

Night mode is generally meant for periods of lower comfort requirements, such as during typical sleeping hours. This mode will result in decreased energy use, and can only be activated via remote control.

	Press the On/Off button to switch the machine on or off
	Press the Change Mode button to select the desired operation mode
	Use the temperature selection buttons to select the desired set point temperature.
	Press the night mode button to turn this feature on or off
	The system automatically keeps the fan speed to low when using this mode

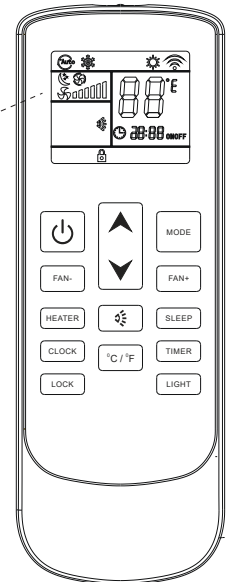
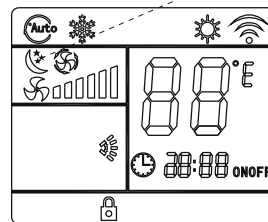









☞ *The selected configuration will be retained in the system's memory when it is switched on again next.*

☞ *This mode sets the ventilation on low speed therefore it is not possible to switch to the other available options.*

# OPERATIONAL INSTRUCTIONS

## Timer On and Timer Off Mode Operation



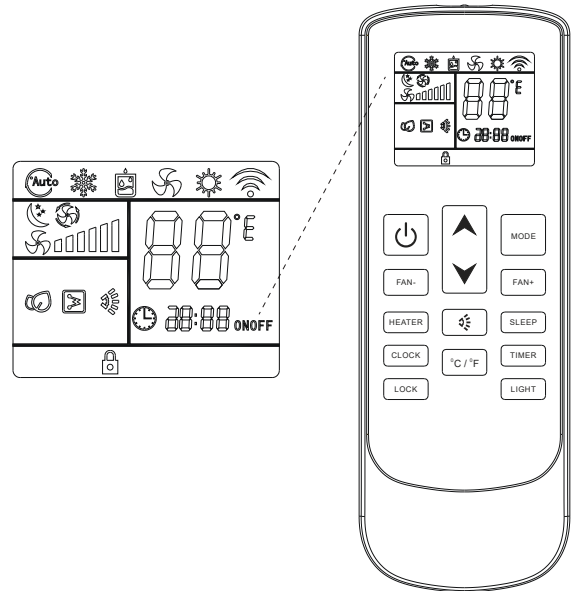

### How to Configure the Timer Off Feature:

	Press the On/Off button to switch the machine on
	Press the Change Mode button to select the desired operation mode
	Use the temperature selection buttons to select the desired set point temperature.
	Press the fan speed button to select low, medium, high, or automatic fan speed
	Press the Timer button to set the time at which the system turns itself off
	Use the temperature selection buttons to modify the time value selection
	Press the Timer button to confirm the selections entered
	Pressing the Timer button once more will deactivate the feature



When the Timer Off button is first pressed, the symbol on the display will be flashing to signify the switch-off feature is being set. Pressing it once more will confirm the data entered, and the icon will remain solid to indicate that Timer Off is set. Pressing it a third time deactivates the Timer Off function.

### How to Configure the Timer On Feature:

	The system must currently be off to configure the Timer On function
	Press the Timer button to set the time at which the system will come on
	Use the temperature selection buttons to modify the time value selection
	Press the Timer button once more to confirm the selections entered
	Pressing the Timer button for a third time will deactivate the feature

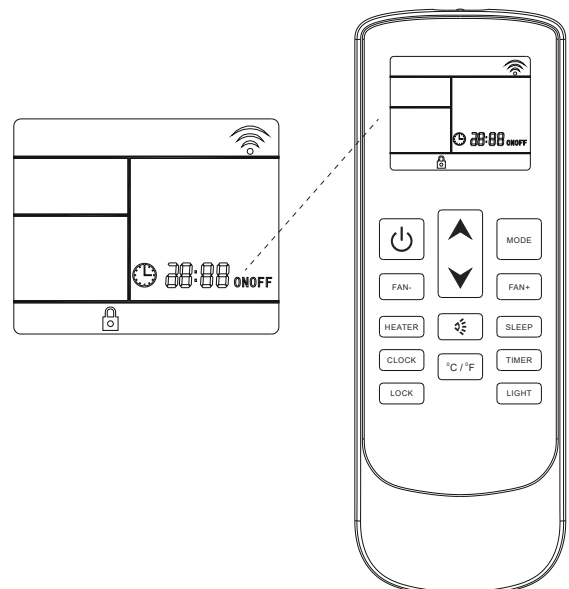

Use the UP arrow to increment the time value up by 1 hour.  
Use the DOWN arrow to increment the time value up by 10 minutes.

The system starts in AUTO mode at time of Timer On activation.

# OPERATIONAL INSTRUCTIONS

## Handling the Remote Controller

### 📌 Installing/Changing the Remote Controller Batteries:

1. Remove the rear battery cover.
2. If there are already batteries installed, remove them and insert two fresh AAA size batteries, ensuring to pay attention to the direction of their polarities (+/-).
3. Slide the rear battery cover of the remote back into place.
4. Check that the remote works properly by pressing the ON button. If on pressing the ON button no icon appears on the display, re-install the batteries and confirm that they are new and have been placed in the correct orientation.
5. The system is now ready to be controlled.

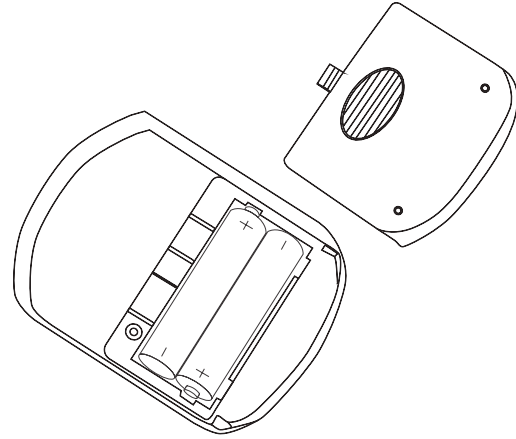

## Description of the Decorative Panel

### 📌 Display Panel Indicator Descriptions

- **Temperature and Error Code Display:** Shows the set temperature, room temperature, and any error codes.
- **Power Light:** The power light will illuminate when the machine is turned on and turn off when the machine is shut down.
- **Compressor Operation Indicator Light:** This light turns on when the compressor is running and turns off when the compressor stops.
- **WIFI Indicator Light:** Indicates the status of the WIFI connection. The light will flash when ready to connect with a mobile app, and remain on continuously once the app is successfully connected.

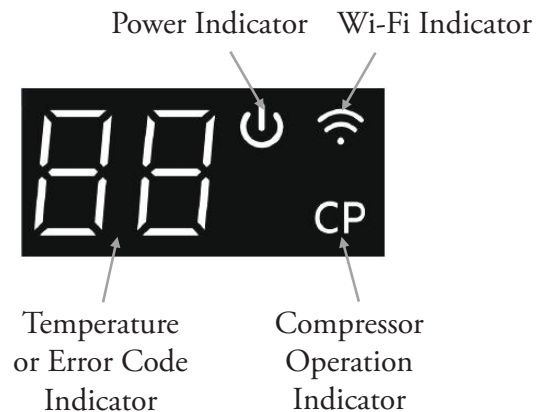

### 📌 Display Panel Buttons and Function Descriptions

- **WIFI Button:** Used to enable or disable the WIFI connection.
- **Urgency ON/OFF Button:** Provides a way to urgently start or shut down the machine when the remote controller is unavailable.

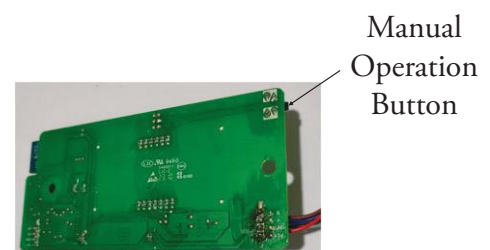

# OPERATIONAL INSTRUCTIONS

## Wi-Fi Connection and Instructions for Usage

### 📍 Installation of “Pioneer Airlink” smartphone application

Search for “Pioneer Airlink” in the Google Play Store (for Android users) or the App Store (for iOS users). Note that a 2.4GHz Wi-Fi connection is needed to use the Wi-Fi control feature.



Or, scan the below QR code to download the app from the respective app store.



Download Android App



Download iOS App

### 📍 Wireless Control App Setup Process

#### 1. Registration and Log-In:

If you do not already have a “Pioneer Airlink” account, please create an account and log-in by following the below steps:

- Approve the “User Agreement” and “Privacy Policy” when they appear by tapping “I Agree”.
- Tap the “Sign Up” button, choose your country, and enter your mobile number/e-mail to register, tick “I Agree” on “User Agreement and Privacy Policy”, then tap the “Get Verification Code” button. The phone or e-mail that you’re registering will receive a registration verification code.
- Enter the verification code and select a password. You will then either land on the homepage of the App, or back to the login interface to log into the app, by using the account you just created.

#### 2. Adding a New Device:

- Confirm that your phone is connected to Wi-Fi (2.4GHz networks only, 5Ghz will not work).
- Tap the “+” at the top-right corner of the homepage, to enter the device selection page.
- Once you’ve entered this page, head to the RV system and press the “Wind Swing” button on the remote control five times within 5 seconds to enter the network distribution mode. On the first attempt, it will enter slow flash distribution mode. Press the “Wind Swing” button five times within 5 seconds again to enter fast flash mode.
- **Clearing WIFI Pairing:** After successful pairing, press the wind speed button five times within 5 seconds to clear the WIFI pairing.

# OPERATIONAL INSTRUCTIONS

## Routine Maintenance

### Cleaning the Filter Screen

To clean the filter screen, follow these steps:

1. Locate the left and right buckles of the decorative panel.
2. Press the buckles to remove the decorative panel and access the filter screen behind it.
3. Rinse the filter screen thoroughly with clean water from the reverse side.
4. Allow the filter screen to dry completely before reinstalling it.

**Note:** Do not operate the air conditioner without the filter screen in place, as this may lead to contamination of the evaporator coil and negatively impact the air conditioner's service life.

### Cleaning the Filter Screen

Use a soft cloth dipped in a neutral detergent to clean the outer surface of the panel. Avoid using polishing agents or cleaning powders.

### Fan Motor Maintenance

The fan motor is pre-lubricated at the factory and does not require special maintenance.

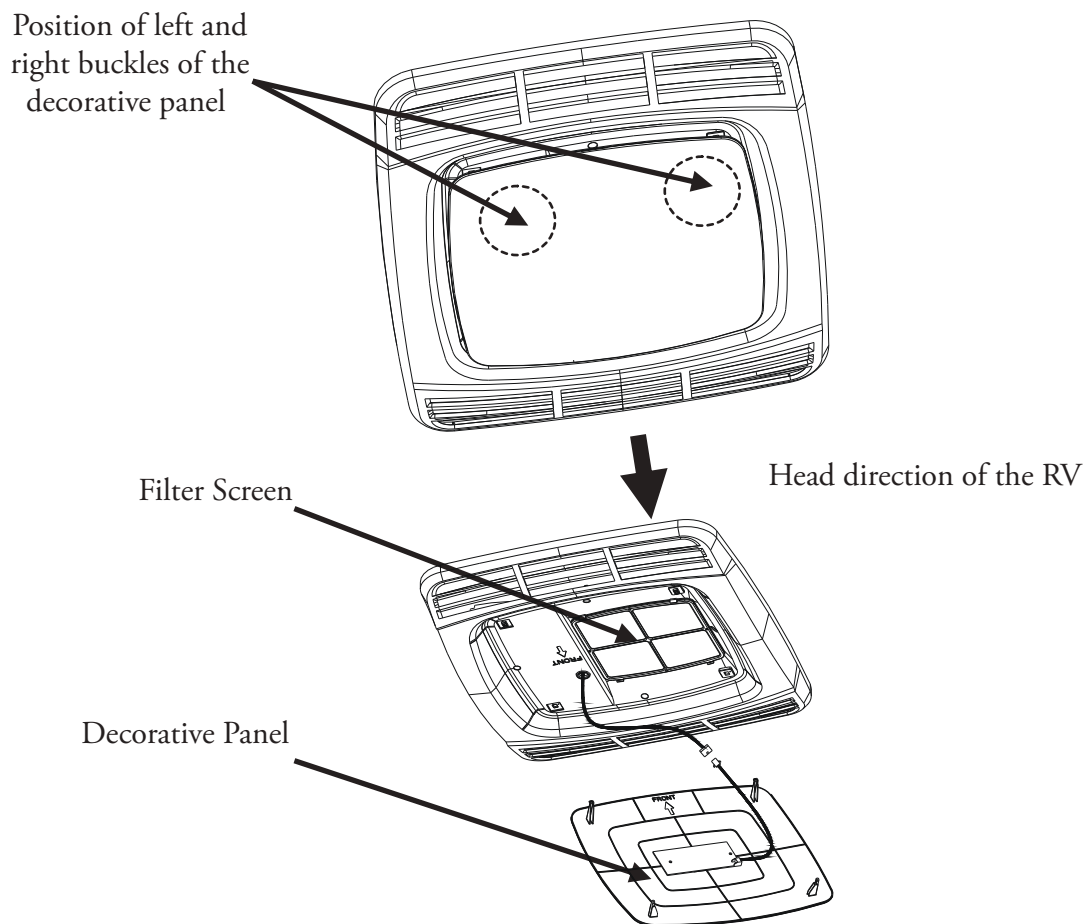

# INSTALLATION INSTRUCTIONS

## Getting Started

### Precautions

Please read the installation and operation instructions carefully before installing and using this product. The manufacturer is not liable for any loss or injury resulting from failure to comply with this manual.

- Installation must adhere to national electrical code regulations or applicable industry standards.
- This product should not be equipped with any additional equipment or accessories without the manufacturer's authorization.
- Installation and maintenance must be performed by qualified personnel.

## Installation Positioning

### Factors for Installation

This product is designed to be installed on the roof of an RV. When determining your cooling requirements, take the following factors into consideration:

- **Size of the RV:** Larger RVs may require more cooling capacity.
- **Window Area:** A larger window area can result in increased heat inside the RV.
- **Thickness and Thermal Insulation:** Consider the thickness and thermal insulation properties of the compartment walls and roof.
- **Geographical Location:** The climate and conditions of the location where the RV is used can impact cooling requirements.

### Selection of Installation Position

This product is intended to be installed on an existing roof vent. Typically, a 14-1/4" x 14-1/4" ± 1/8" opening will be available on the roof after the vent is removed.

If there is no vent on the roof, or if this product needs to be installed in another position, it is recommended to follow these guidelines:

1. When installing a single air conditioner, it should be positioned slightly ahead of the center point (as viewed from the front of the vehicle) and centered between the left and right sides, as shown in the following figure.
2. When installing two air conditioners, they should be positioned at the 1/3 and 2/3 points from the front end of the RV, and centered between the left and right sides, as illustrated in the following figure.

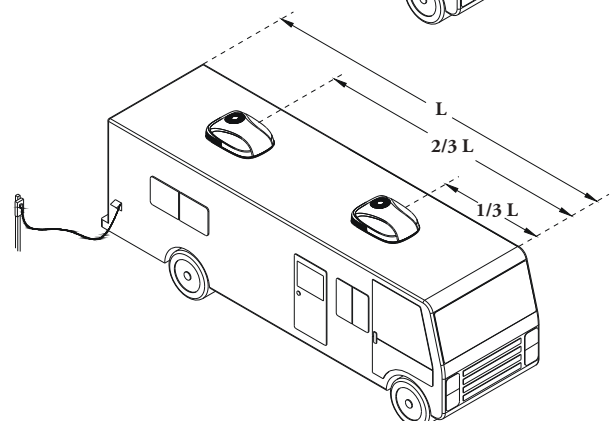
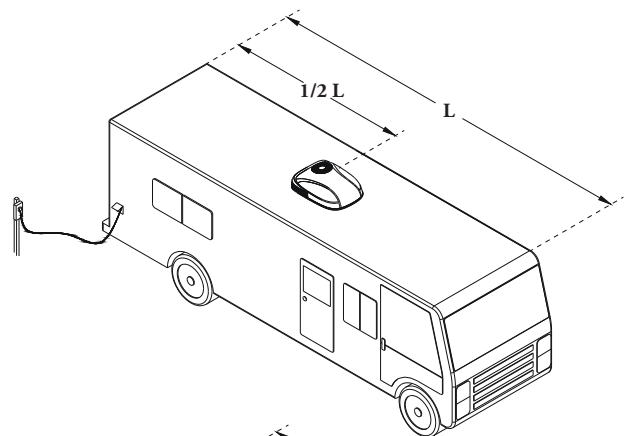

# INSTALLATION INSTRUCTIONS

## Guidelines for a Successful Installation

For optimal performance, this product should be installed horizontally (assuming the RV is parked on a level surface) with a maximum allowable gradient of no more than 15°.

Once the installation position is determined, check for any obstacles in the designated area. Ensure that there is a minimum distance of 18 inches between the back of the vehicle body and any other roof equipment.

When the RV is in motion, the roof must be capable of supporting a load of 135 lbs. Typically, a static load design of 220 lbs is sufficient to meet this requirement.

Additionally, verify that there are no obstacles, such as door openings, partition frames, curtains, or ceiling fixtures, that would interfere with the installation of the inner panel of the air conditioner.

## Dimensional Information

The overall dimensions of the RV rooftop heat pump system and panel are as follows:

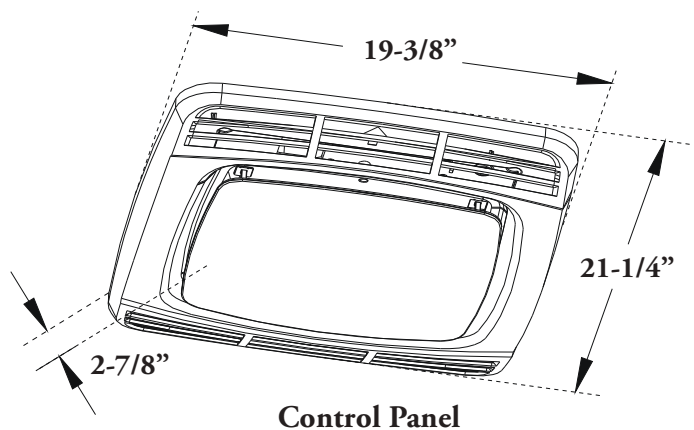
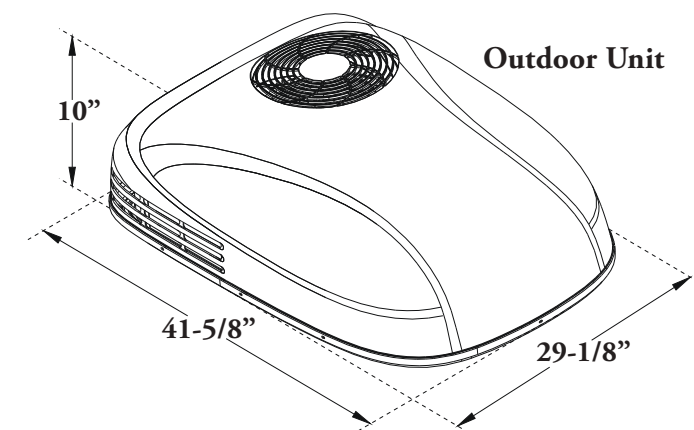

### Installation Exploded Diagram

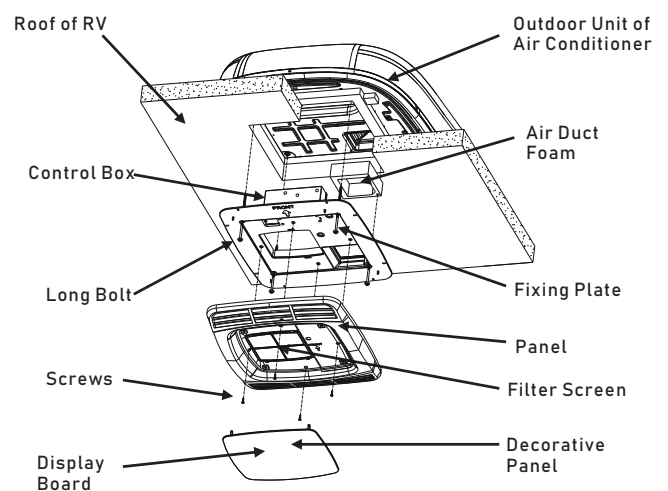

# INSTALLATION INSTRUCTIONS

## Creation of Roof Opening

### ⓘ Preparation for Installation

1. Unscrew and remove the screws to detach the vent.
2. Remove all joint fillers around the opening.
3. Seal all screw holes and joints on the roof washer using a high-quality, all-weather sealant to ensure a proper seal.

### ⓘ Creating a New Roof Opening (Not for Vent Installation)

#### ⚡ WARNING

*Wiring may be present between the roof and ceiling. Before installation, ensure the 115V AC power supply is turned off. Failure to follow this instruction can result in electric shock, potentially leading to serious injury or death.*

- Mark a  $14\text{-}1/4" \times 14\text{-}1/4" \pm 1/8"$  square on the roof and carefully cut out the opening.
- Next, cut a matching hole in the ceiling aligned with the roof opening, as illustrated in the following figure.

*Ensure there are no obstacles within a minimum distance of 18 inches from the back of the vehicle body. This opening must be positioned between the roof reinforcements and extend through both the roof and ceiling of the RV.*

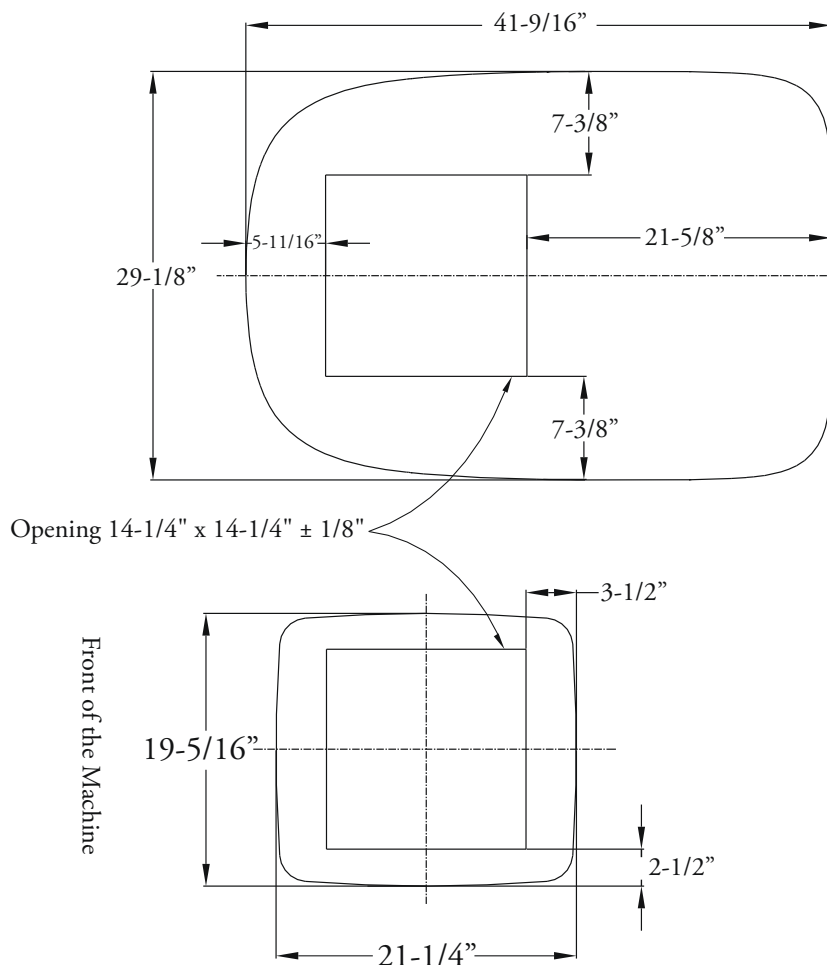

- If the opening exceeds  $14\text{-}3/8" \times 14\text{-}3/8"$ , liners or fillers must be employed to seal the leftover gap.
- If the opening is less than  $14\text{-}1/8" \times 14\text{-}1/8"$ , the opening must be enlarged.

# INSTALLATION INSTRUCTIONS

## Electrical Setup

### ⓘ Wiring Requirements

- All wiring methods must comply with all applicable national and local electrical regulations.
- A fuse or circuit breaker should be installed, and proper grounding must be ensured. Extend a field-supplied 12 AWG copper cable from the circuit breaker to the front position of the roof opening.
  - The power line must be on a dedicated 20A time delay circuit breaker.
- Ensure the wire extends at least 15 inches into the roof opening to facilitate the installation of the main air conditioning unit.
- If the existing wire from the removed ventilator is of an appropriate size and the fuse specification is suitable, it may be reused.
- Use appropriate conduit for protecting any wires entering the opening to prevent damage.

## Opening Treatment

The opening must be properly supported, and the roof interlayer should be filled with insulating materials. To prevent resonance caused by air within the upper interlayer, seal the perimeter using battens or insulating strips that are at least 3/4 inch thick.

Additionally, provide an entry point for the power line, as illustrated in the following figure:

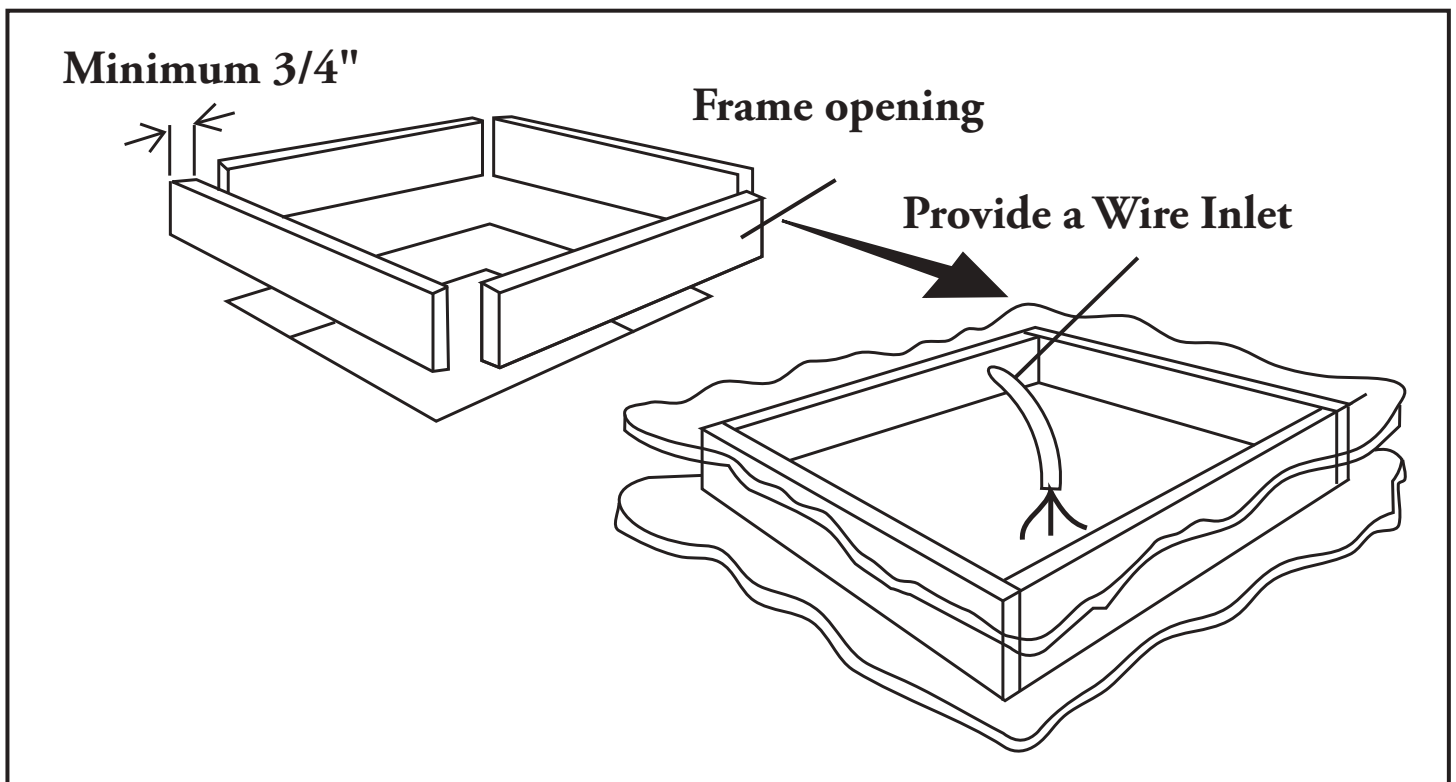

The 14-1/4" x 14-1/4" ± 1/8" roof opening forms an integral part of the return air duct, and must be smoothed and finished in accordance with industry standards.

### ⚠ WARNING

*The installation personnel are responsible for ensuring the structural integrity of the RV's roof during air conditioning installation.*

*Avoid creating any low-lying areas where water may accumulate on the roof, as stagnant water can seep into the vehicle and potentially cause damage to both the air conditioning unit and the RV.*

# INSTALLATION INSTRUCTIONS

## Placement of Air Conditioner Onto Roof

### **Precaution**

*Variants of this machine can weigh up to 100 pounds. To prevent unintentional damage to the equipment, it is highly recommended to use a crane or lifting device to raise the system onto the roof of the RV.*

1. Remove the outdoor unit of the air conditioner from the carton.
2. Carefully place the outdoor unit on the roof of the RV.
3. Lift the equipment—**do not drag it**—by using the box sponge of the air conditioner, and position it over the prepared opening, with the condenser coil facing the rear of the RV, as illustrated in the following figure:



### **WARNING**

*Dragging the air conditioner is strictly prohibited, as it can damage the insulation at the bottom. Doing so may lead to water leakage due to improper sealing of the insulation after installation.*

Next, install the panel assembly inside the RV. The panel assembly includes fasteners designed for securing the air conditioner, which will be used during installation, as illustrated in the following figure.

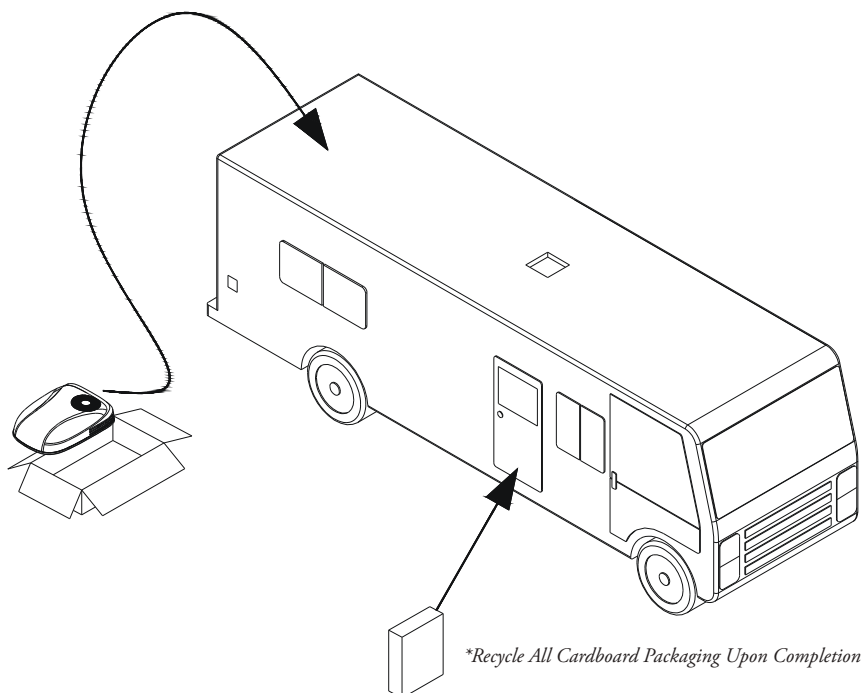

If any misalignment is found with the outdoor unit's positioning on the roof during panel installation, the outdoor unit can be adjusted from inside through the mounting hole. Ensure that the bottom part's insulation on the roof is precisely aligned with the 14-1/4" x 14-1/4" square opening.

# INSTALLATION INSTRUCTIONS

## Interior Mounting and Connections

### ① Installation of Air Duct and Top Mounting Plate

1. Remove the panel and installation accessories from the carton.
2. Reach through the return air inlet of the air conditioner and pull down the wire harness of the outdoor unit (for heat pump models, this also includes the four-way valve connecting wire and sensor lead) to facilitate subsequent connections, as illustrated in the following figure:

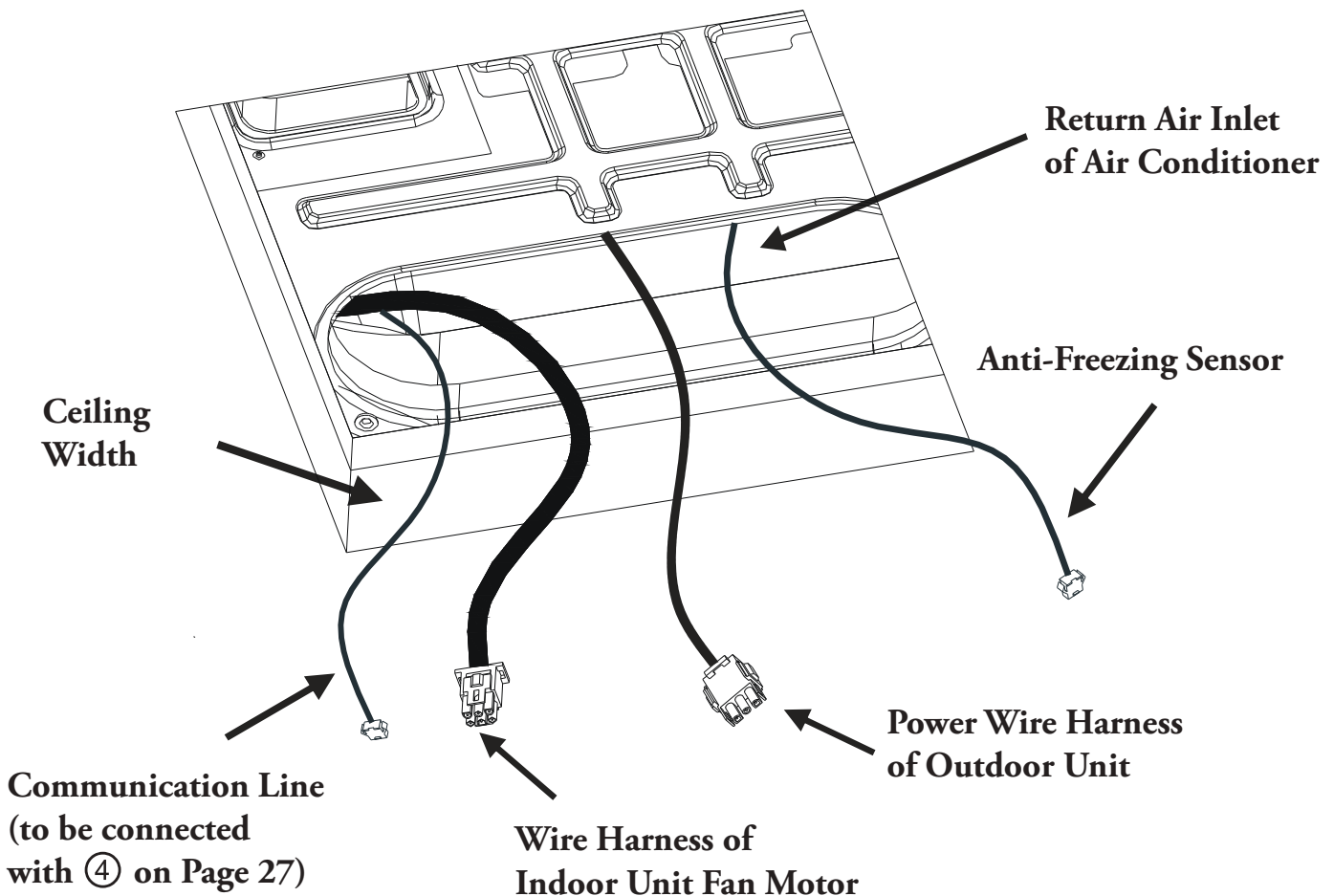

### ① Preparation of Air Duct Foam

Measure the width from the ceiling to the roof and select the appropriate air duct foam thickness based on the following guidelines:

1. For a width of 2.5 - 3cm, use an air duct foam with a thickness of 1.5cm.
2. For a width of 3 - 4.5cm, use an air duct foam with a thickness of 3cm.
3. For a width of 4 - 6cm, use an air duct foam with a thickness of 4.5cm.
4. If the width is greater than 6cm, combine air duct foams of 1.5, 3, and 4.5cm thicknesses as needed based on the actual situation.
5. For a distance greater than 10cm, a field-supplied pipe joint should be used.

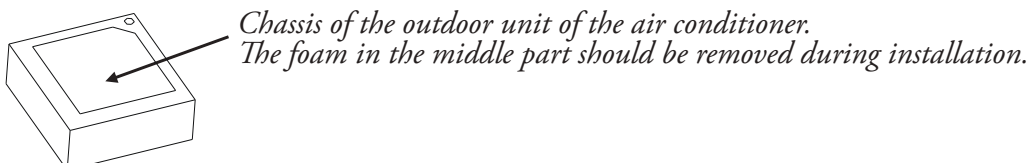

# INSTALLATION INSTRUCTIONS

## Installation of Air Duct Foam

### ⓘ Air Duct Foam (Available in Three Thicknesses: 1.5, 3, and 4.5cm)

**Note:** Middle portion of air duct foam is intended to prevent deformation and should be removed during installation.

Select the appropriate air duct foam thickness, remove the middle portion, and affix it to the fixing plate along the air outlet. Ensure that the holes on the foam align with the holes on the fastening plate, as illustrated in the following figure:

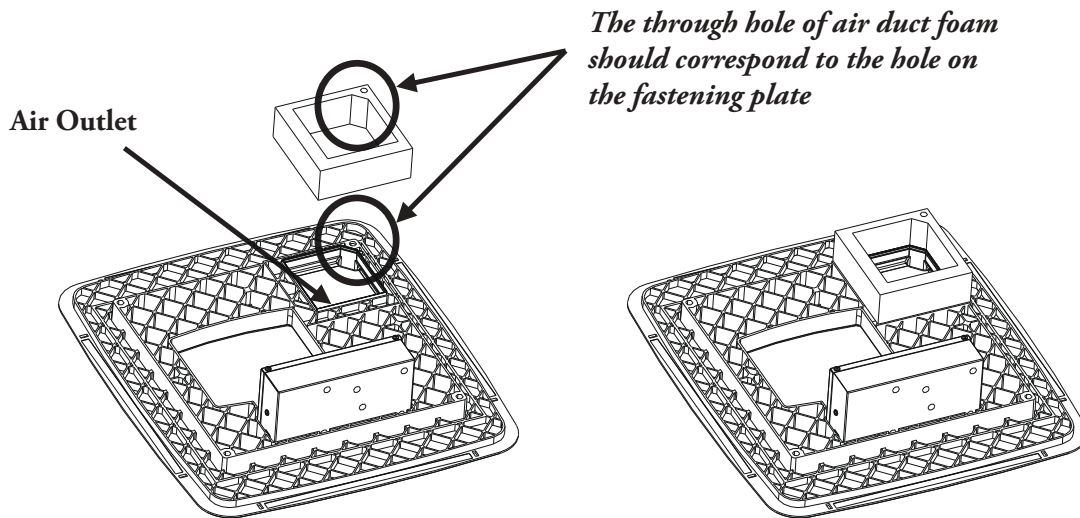

Align the arrow on the fastening plate toward the front of the RV, position the plate over the 14-1/4" x 14-1/4" ceiling opening, and secure it to the outdoor unit of air conditioner on the roof using four bolts of suitable length.

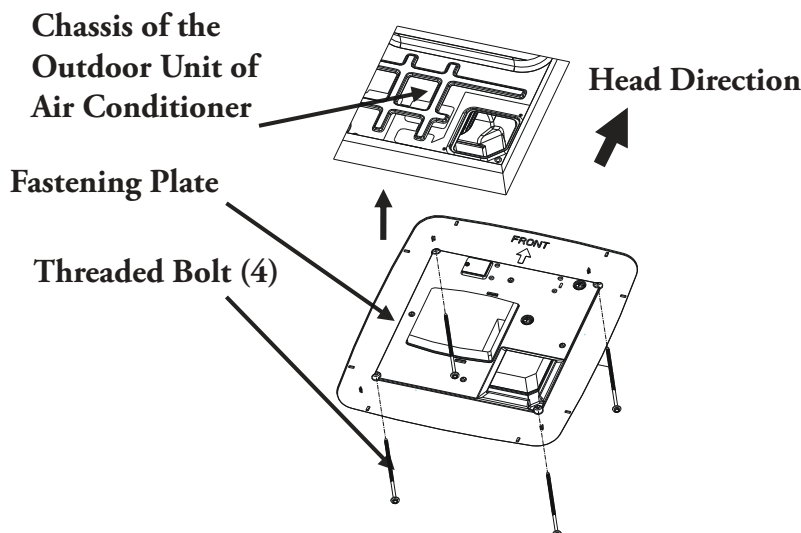

**Note:** Before fully tightening the bolts, begin by screwing each bolt in by hand. The four rivet nuts on the chassis of the outdoor unit are located at the corners of the opening. Insert and hand-tighten the four long bolts into the corresponding rivet nuts. Once all bolts are in place, tighten them evenly, one at a time, with a torque of 3.3 ft·lbs to 4 ft·lbs. This will compress the box foam on the roof to a thickness of approximately 1/2". These bolts are self-locking, so excessive tightening is not necessary.

If the bolts are too loose, the roof may not be adequately sealed. Conversely, overtightening the bolts could cause damage to the air conditioner chassis or the fixing plate. Tighten the bolts according to the torque specifications provided above.

# INSTALLATION INSTRUCTIONS

## Electrical Wiring

### **WARNING**

*Disconnect the main power supply before performing any work. Failure to comply with this instruction can result in electric shock, leading to serious injury or death.*

*The air conditioning equipment must be properly grounded to prevent electric shock hazards. Ensure that the equipment is connected to a 115V/60Hz circuit with reliable grounding. Failure to follow these instructions may result in death, injury, or equipment damage.*

*Electrical installation must be performed by qualified professionals, and all wiring must comply with national electrical codes and industry standards.*

### *Interior Underside View of Air Conditioner*

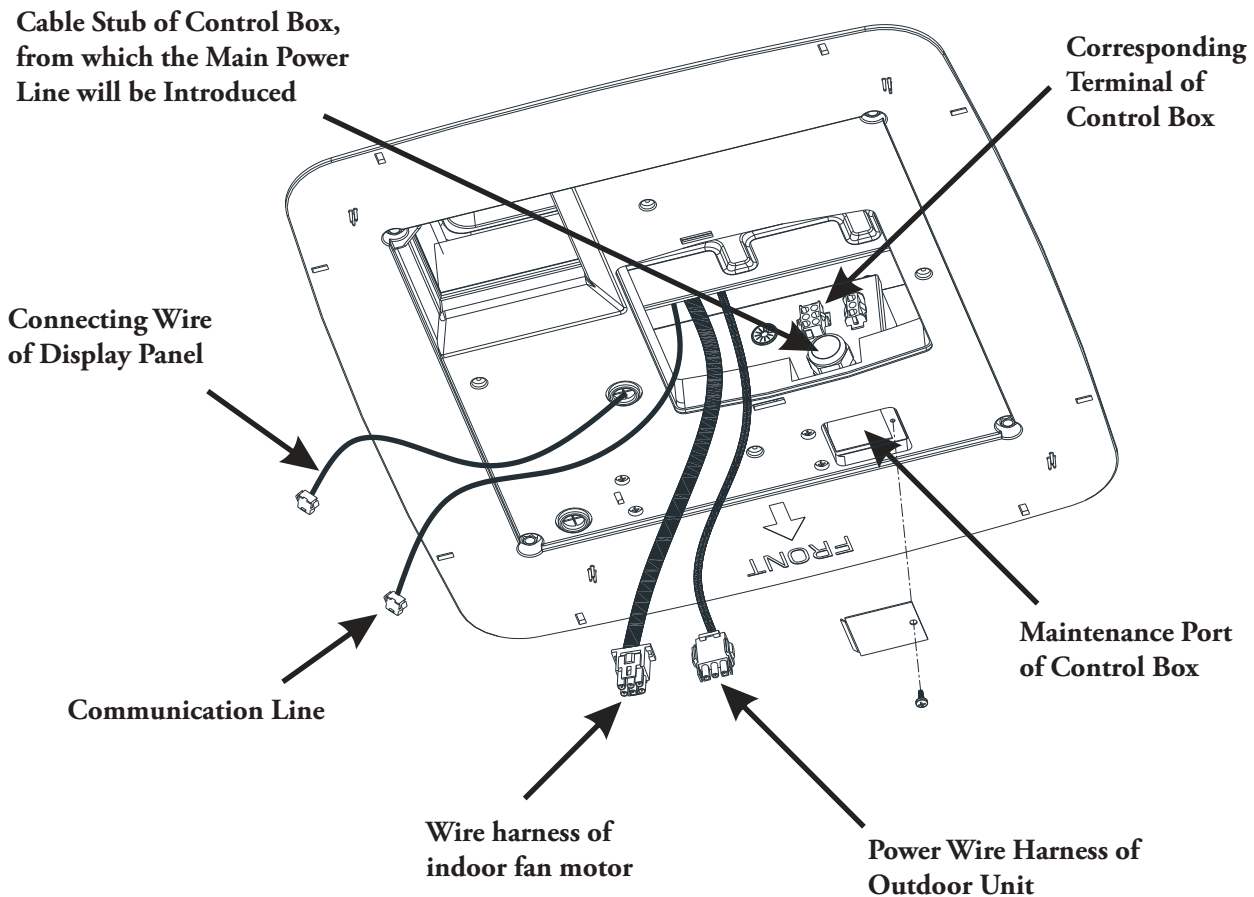

First, remove the maintenance plate covering the maintenance port of the control box. Feed the main power line (approximately 6 inches long) into the control box through the cable stub. Secure the cable stub to prevent the main power line from being pulled, which could lead to loose connections.

Connect the wires as follows:

- The white wire in the control box should be connected to the white wire (neutral wire) of the main power line.
- The black wire should be connected to the black wire (live wire) of the main power line.
- The yellow-green wire should be connected to the yellow-green wire (ground wire) of the main power line.

Use specialized wiring connectors for fastening these wires, ensuring they are well-secured and firmly in place.

# INSTALLATION INSTRUCTIONS

## System Connections

Place the connected wires back into the maintenance port of the control box and reattach the maintenance plate. Insert the outdoor unit's plug-in wire harness, which was pulled out from the return air outlet of the air conditioner, into the corresponding six-core terminal plug of the control box. (For heat pump or electric heating models, the three-core plug from the return air outlet should be inserted into the corresponding three-core terminal plug.) Ensure all plug-in terminals are properly seated.

Connect the remaining plug-in wires on the control box as follows:

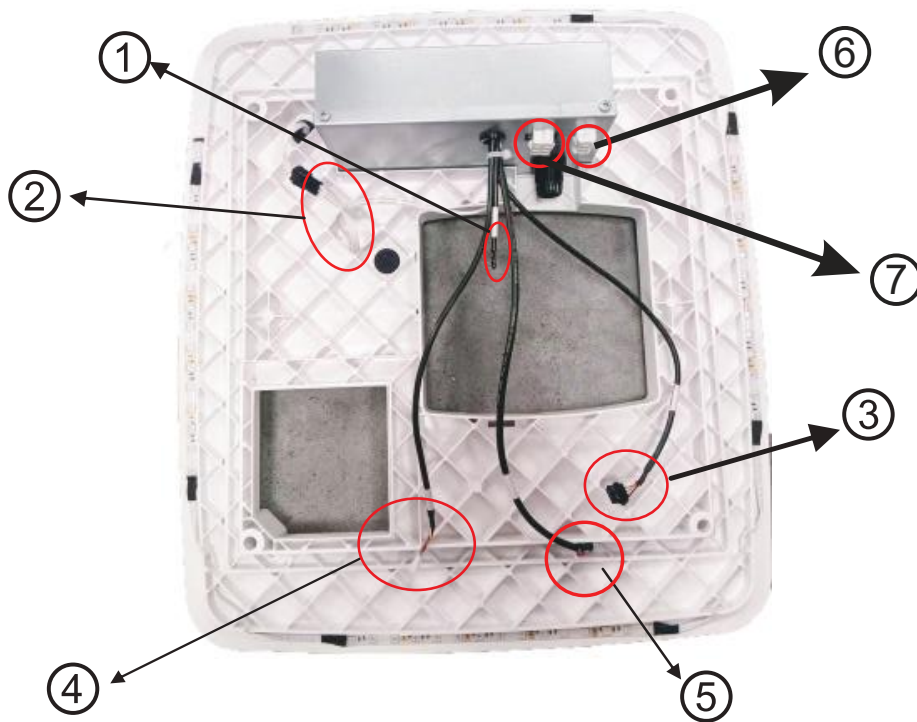

- ① Indoor Temp Sensor;
- ② LED Strip Wire;
- ③ Connecting Wire of Display Panel;
- ④ Communication Line;
- ⑤ Anti-Freezing Sensor
- ⑥ Wire Harness of Electric Heater
- ⑦ Power Wire Harness of Outdoor Unit

Left and right buckles  
on the decorative panel

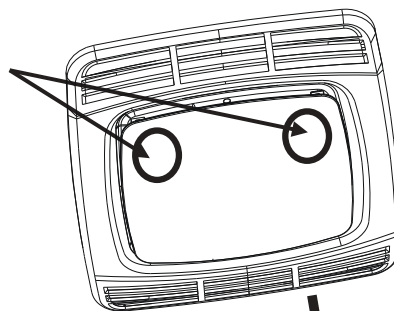

Arrow direction on the panel  
(vehicle head direction)

# INSTALLATION INSTRUCTIONS

## Mounting the Panel

### Alignment and Connection

Remove the panel and align it according to the directional indicators on the panel. Pass the display panel's connecting wire from the control box through the via hole on the panel. Attach the panel to the fixing plate and secure it tightly using four screws, as illustrated in the following figure:

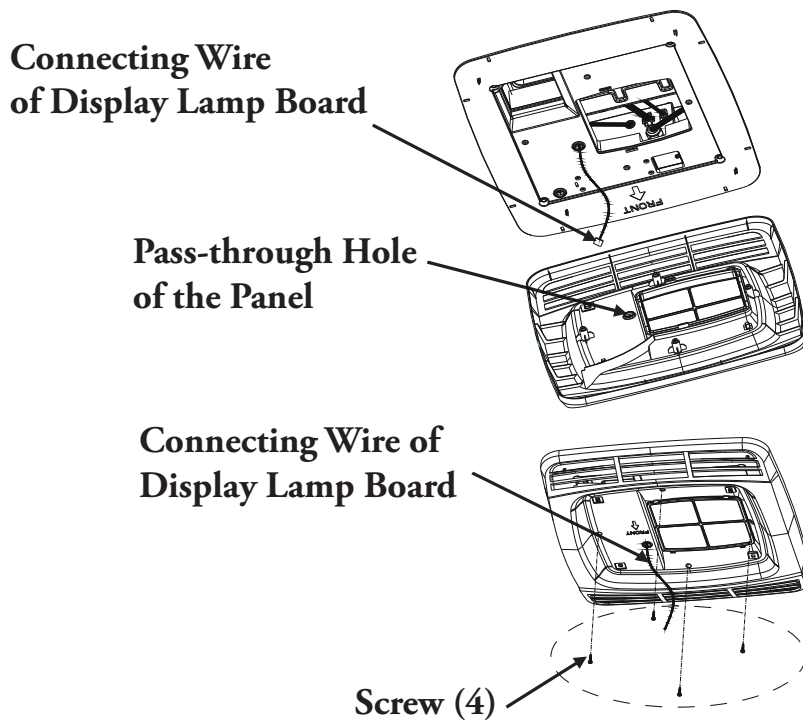

Take out the decorative panel, and with the arrow direction facing the head of RV, plug the connecting wire of display lamp board with the connecting wire of display lamp board of the decorative panel in place, and then install the lamp board on the panel (when installing the decorative panel, first clamp the two buckles in arrow direction on the corresponding holes of the panel, and then clamp the rear two buckles on the panel lock), as shown in the following figure:

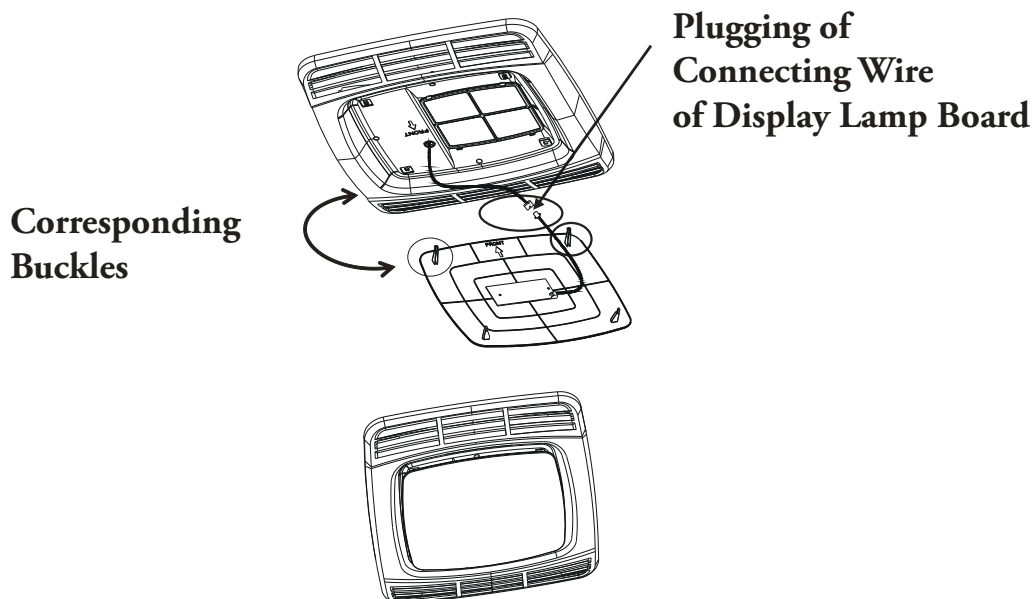

# INSTALLATION INSTRUCTIONS

## Initialization of System

After the air conditioning equipment is installed, turn on the power supply to perform a running inspection. Be sure to read the operation instructions thoroughly before proceeding with further operation.

The permanent wiring for the air conditioning control box can be connected from the main incoming line of the RV, which is routed along the side wall, as illustrated in the following figure.

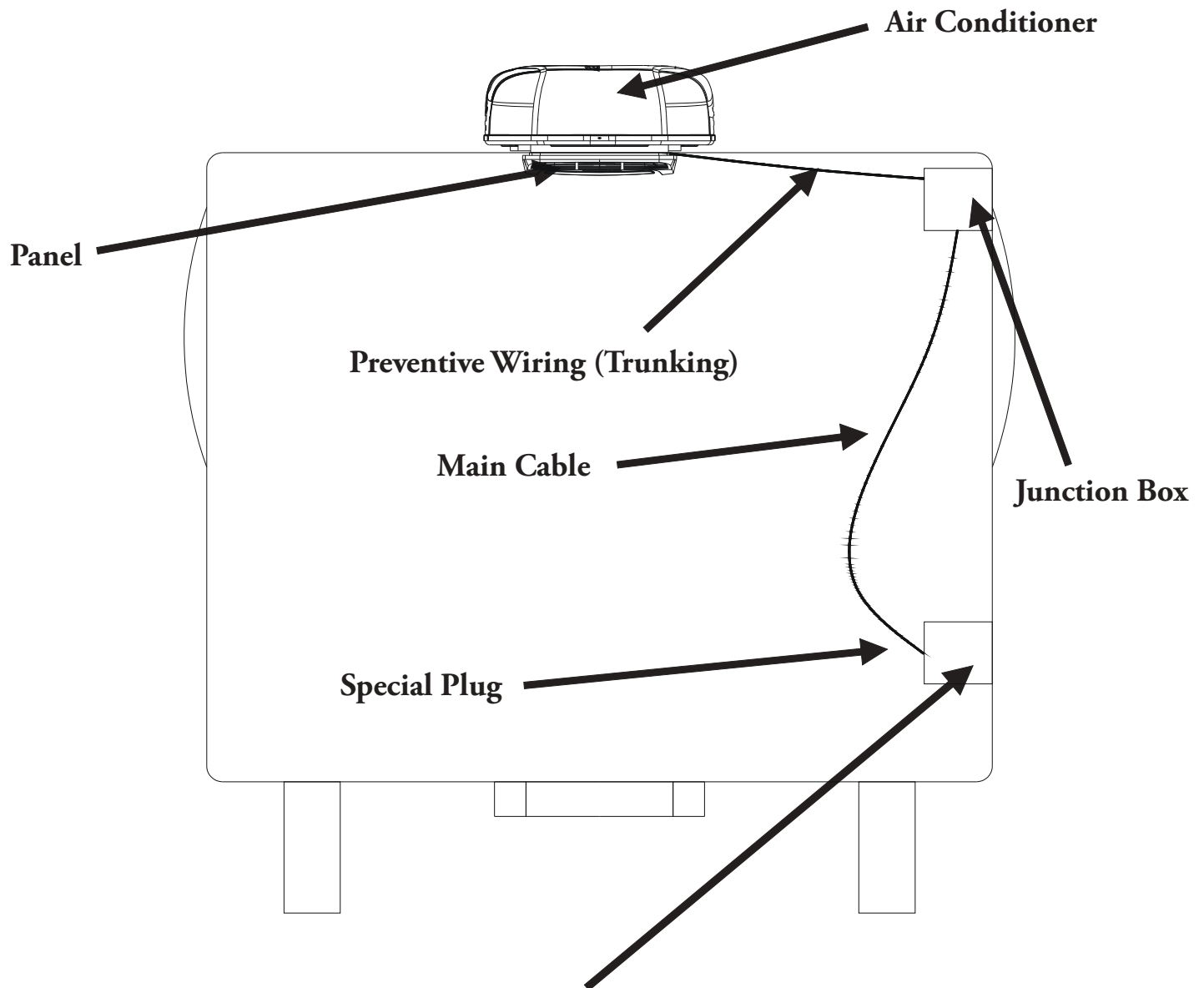

*It's forbidden to insert other plugs into this circuit*

A dedicated socket for the air conditioning equipment should be installed on the side wall of the RV.

The cable must be connected to both the socket and the fuse.

The main connecting cable should be resistant to oil, water, and ozone corrosion.

# DIAGNOSTICS, TECHNICAL CHARACTERISTICS, RECYCLING

## Troubleshooting

If the air conditioning equipment is not functioning properly, please perform the following checks to troubleshoot the issue:

- Verify that the fuse for the air conditioning equipment or the RV's leakage circuit breaker is turned on.

If the air conditioner is powered by a generator, check whether:

- The generator's power output matches the air conditioner's requirements.
- The generator is operating correctly and producing electricity.
- The generator's voltage output is stable.

If the RV is connected to the main power supply, ensure that:

- The power line specifications are suitable for the air conditioner's operating load.
- There is an active power supply.
- The mains voltage meets the required specifications (operating voltage for the air conditioner is 115V).
- Check that all air conditioner connecting wires are properly inserted and in good condition.

If the air conditioner still does not operate correctly after these checks, please contact the manufacturer for further assistance.

## Error Code Interpretation

Error Type	Error Code	Cause of Error
Fault	EE	Indoor Unit EEPROM
	E3	Indoor Coil Temperature Sensor
	E4	Indoor Ambient Temp Sensor
	E7	Outdoor Unit Board and/or Drive Board Communication
	E0	Outdoor Unit EEPROM
	E6	Main Board and Drive Board communication
	F1*	Abnormal Compressor Startup
	F2*	Compressor Out of Step
	F3	IPM Module
	F5	Discharge Temperature Sensor
	F6	Suction Temperature Sensor
	F7	Outdoor Coil Temperature Sensor
	F8	Outdoor Ambient Temperature Sensor
	F9	Outdoor DC Fan Motor
	E9	Display Board and Main Board Communication
	Er	Wrong Model Selection

Error Type	Error Code	Cause of Error
Protection	P1	Outdoor Unit Current Overload
	P2	Compressor Phase Current
	P3	Outdoor Unit Over/Under-Voltage
	P4	DC Busbar Over/Under-Voltage
	P5	IPM Over Temperature
	P6	Discharge Temp Overheating
	P7	Anti-Freezing Protection for Indoor Coil When Cooling
	P8	Overheating Protection for Outdoor Coil When Cooling
	P9	Overheating Protection for Indoor Coil When Heating
	PC	Outdoor Ambient Low Temperature Protection When Cooling
PH	Outdoor Ambient High Temperature Protection When Heating	
Drive	L1*	Over-Voltage Protection of Busbar
	L2*	Under-Voltage Protection of Busbar
	L3*	Over Current Protection of Phase
	L4*	Abnormal Phase Current Sampling

***\*System lock if occurring 6 times within 20 min. Switch the system off/on to clear this error code.***

# DIAGNOSTICS, TECHNICAL CHARACTERISTICS, RECYCLING

## Technical System Information

### WIRING DIAGRAM

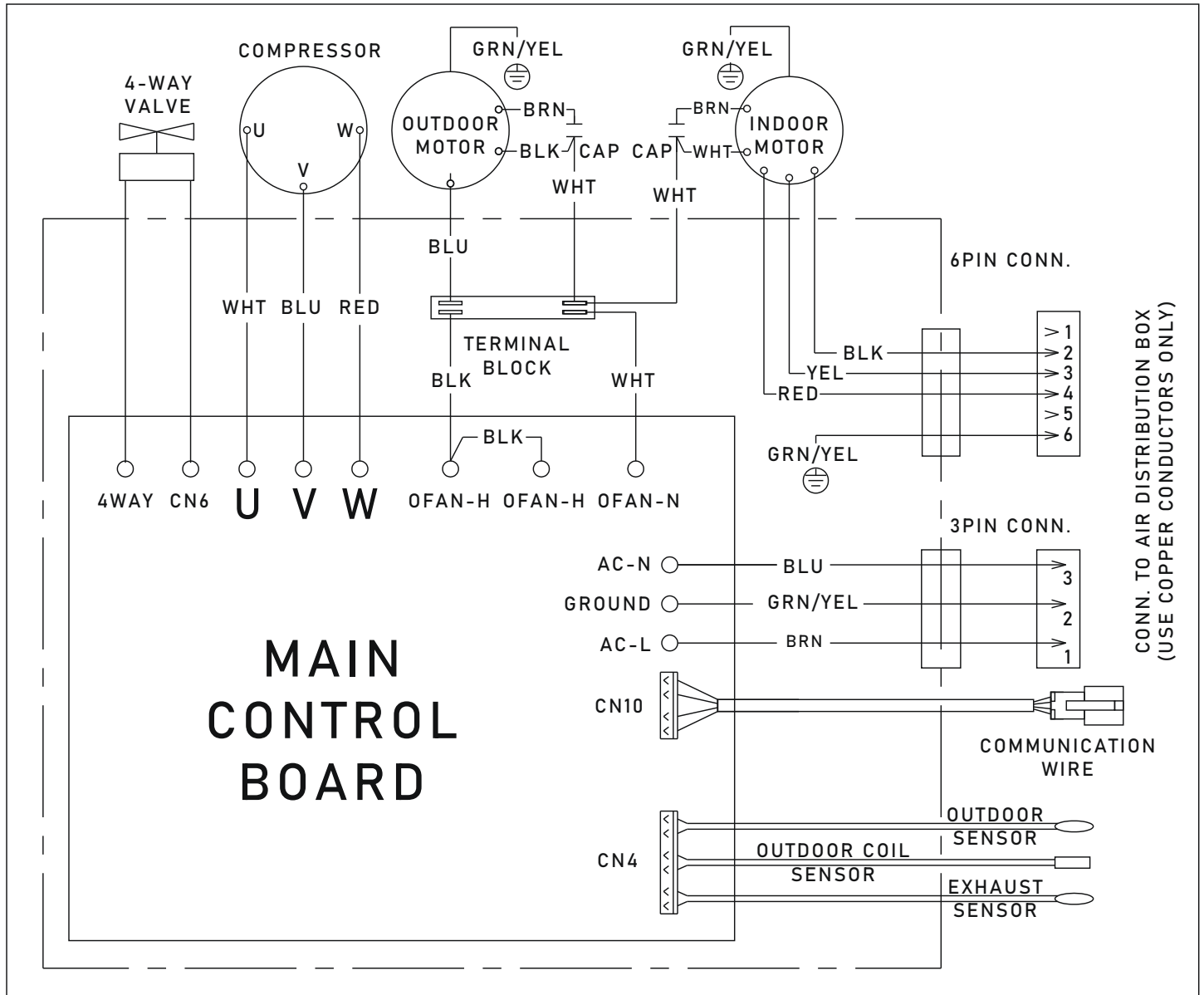

### DIGITAL CONTROL

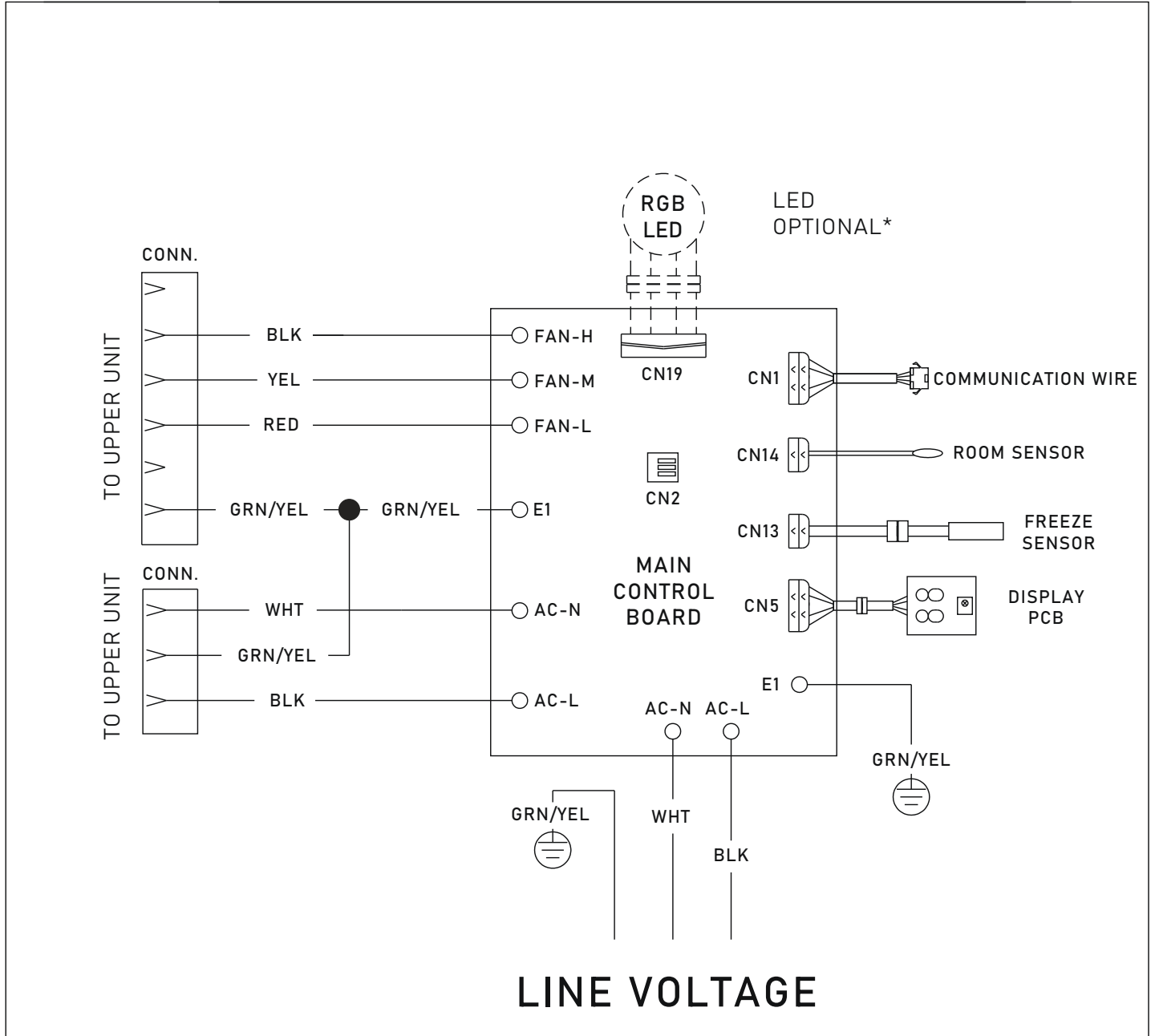

# DIAGNOSTICS, TECHNICAL CHARACTERISTICS, RECYCLING

## European Disposal Guidelines

This appliance contains refrigerant and other potentially hazardous materials. When disposing of this appliance, the law requires special collection and treatment. Do not dispose of this product as household waste or unsorted municipal waste.

When disposing of this appliance, you have the following options:

- Dispose of the appliance at a designated municipal electronic waste collection facility.
- When buying a new appliance, the retailer takes back the old appliance free of charge.
- The manufacturer takes back the old appliance free of charge.
- Sell the appliance to certified scrap metal dealers.

### Special Notice

Disposing of this appliance improperly, or in other natural surroundings, endangers your health and is bad for the environment. Hazardous substances may leak into the ground water and enter the food chain. Please follow proper disposal protocol.

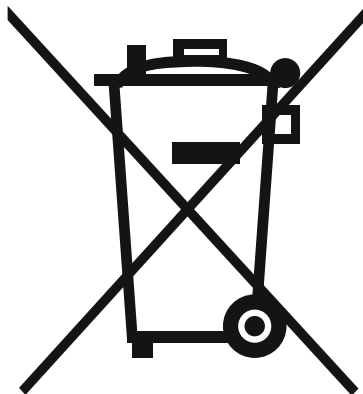

The design and specifications of this product are subject to change without prior notice as development continues. Consult with the sales agency or manufacturer for details. Refer to the equipment nameplate for all other applicable specifications.



is a registered trademark of Parker Davis HVAC International

Parker Davis HVAC International  
7290 NW 77th Court, Miami, FL 33166 - USA  
Tel : (305) 513-4488  
Fax : (305) 513-4499  
E-mail : [info@pdhvac.com](mailto:info@pdhvac.com)  
Website : [www.pdhvac.com](http://www.pdhvac.com)

Pioneer product line, parts, and supplies are available online for convenient ordering at:  
[www.highseer.com](http://www.highseer.com)  
[www.pioneerminisplit.com](http://www.pioneerminisplit.com)

Scan the below code to visit our support page where you can find more installation materials:

