

User Manual

Wireless Audio Adapter

BTTC-417

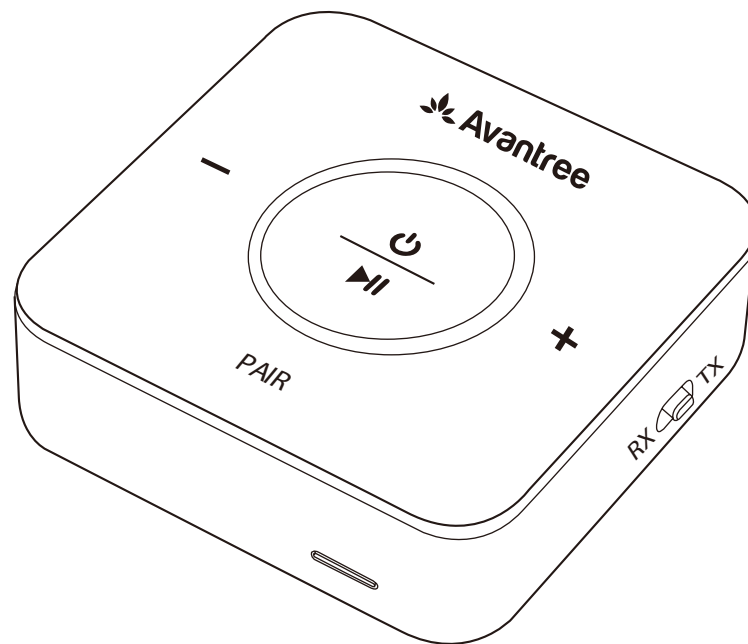

Overview	1
Basic Operation & LED Indication	1
Works as Bluetooth Transmitter (TX Mode)	2
Pair and connect to Bluetooth headphone/receiver	2
Check your TV/Audio Source output options	3
Connect the TC417 to your TV/audio source	3
TV with optical audio out	3
TV with AUX 3.5mm audio out	4
TV with RCA Audio Out (Red/White ports labeled "AUDIO OUT")	5
Receiver with 6.35mm Phone Jack at Front	5
Works as Bluetooth Receiver (RX Mode)	6
Tips	7
Troubleshooting	8

Overview

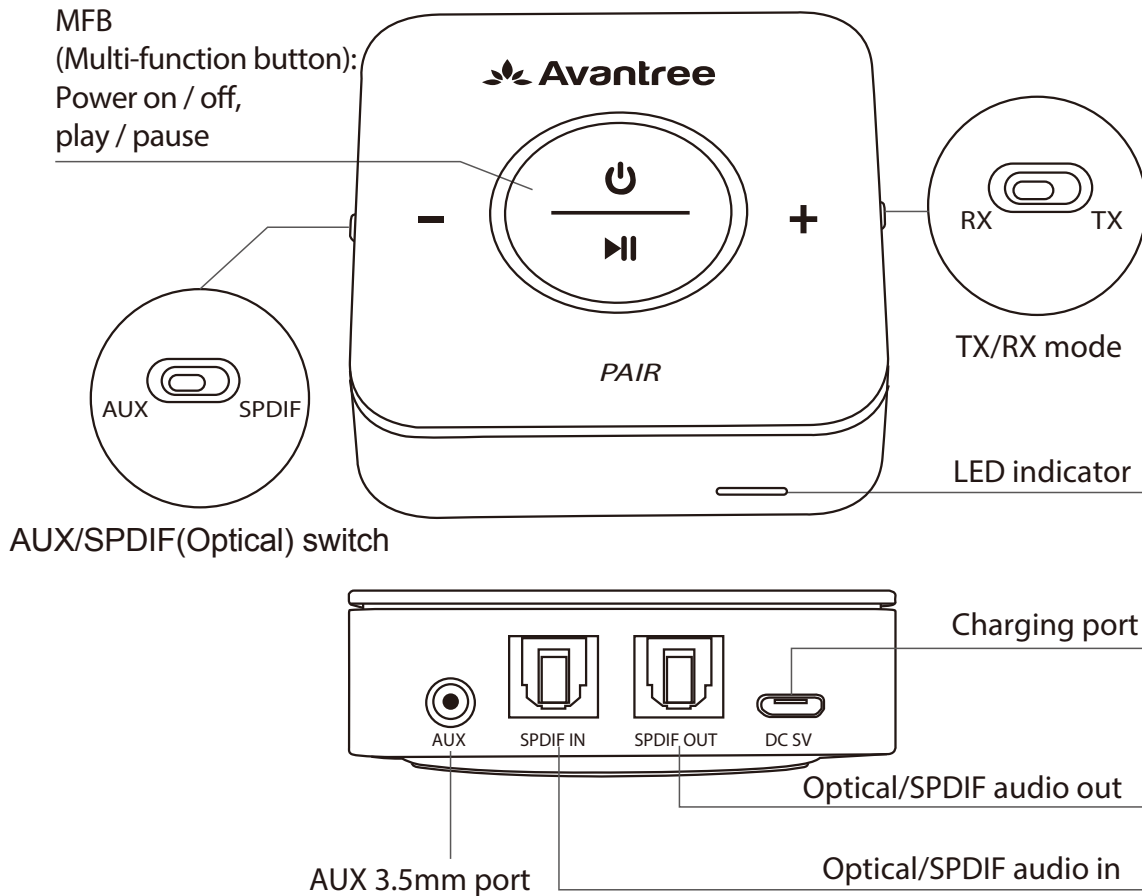

Basic Operation & LED Indication

Status	Operation	LED indication
Power on	Press and hold MFB for 3 seconds	LED flashes GREEN slowly(TX Mode) LED flashes BLUE (RX Mode)
Pairing	After power on, press and hold PAIR for 2 seconds	LED flashes GREEN quickly (TX Mode) LED flashes BLUE quickly(RX Mode)
Connected	/	LED turn SOLID GREEN (TX Mode) LED turn SOLID BLUE (RX Mode)
Reconnection	/	LED flashes GREEN slowly(TX Mode)
Power off	Press and hold MFB for 3 seconds	LED turn off
Volume up/down	Tap +/-	/
Low battery	/	LED flashes RED quickly

Works as Bluetooth Transmitter (TX Mode)

Pair and connect to Bluetooth headphone/receiver

1. **Turn on the TC417:** Press and hold MFB button for 3 seconds until you see **GREEN** light.

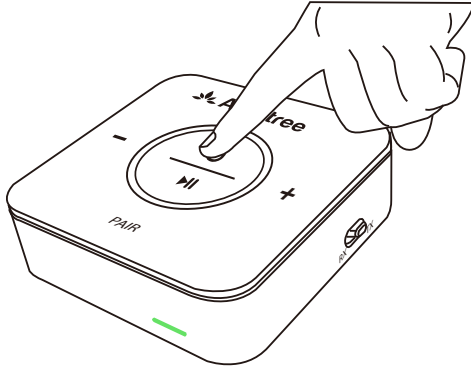

2. **Set the TC417 to TX mode:** Slide TX/RX switch to "TX" position.

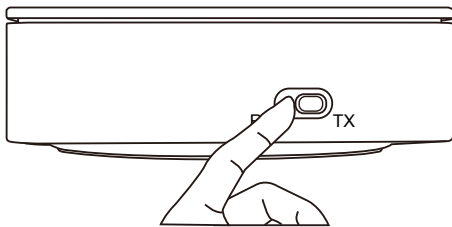

3. **Enter the TC417 into PAIRING MODE:** On first use, the TC417 will enter pairing mode automatically. The LED indicator will flash **GREEN** rapidly. Alternatively, press and hold the PAIR button for 2 seconds to enter pairing mode.
4. **Enter headphones into PAIRING MODE:** Please refer to your headphone's user manual (Usually the LED on headphones flash Blue and Red alternately or flash Blue rapidly when in pairing mode).
5. **Connecting:** During the pairing process, keep the devices close to each other and wait. Once connected, LED indicator stays **SOLID GREEN**.

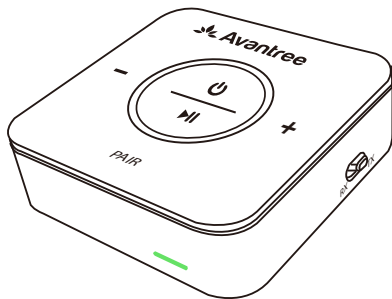

Reconnect

NO need to re-pair the transmitter and headphones for each use. The transmitter will ALWAYS auto reconnect to the last paired device within 5-10 seconds after powering on both devices. Alternatively, restart both the transmitter and headphones and wait 5 -10 seconds for them to reconnect.

Check your TV/Audio Source output options

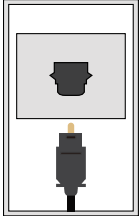
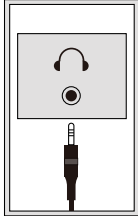
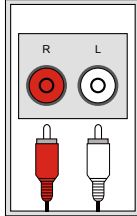
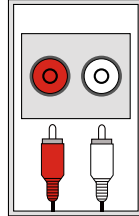
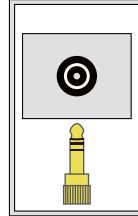
	Optical OUT	AUX/3.5mm	RCA jacks labeled "AUDIO OUT"	Other RCA jacks (usually audio IN)	Big Phone Jack
Jack Options					
Natively Supported?	✓	✓	✓	✗	✓✗
Please refer to Point:	3.3.1	3.3.2	3.3.3	N/A	3.3.4

Connect the TC417 to your TV/audio source

TV with OPTICAL audio out

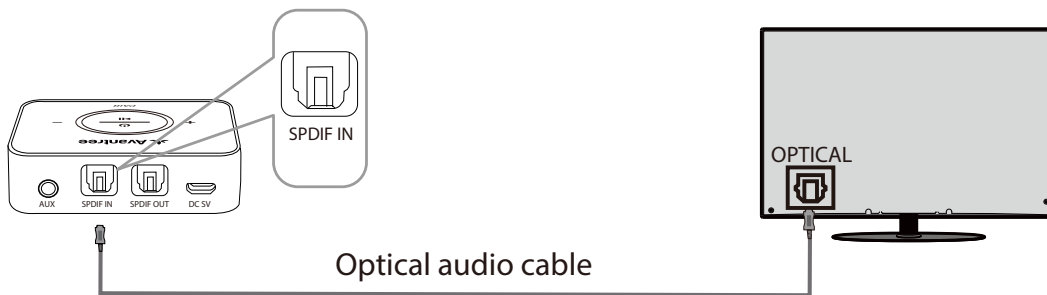

After connecting your optical cable you should be able to hear sound from your headphones; if not:

- 1) Ensure the AUX/SPDIF(Optical) switch on the TC417 is set to the "SPDIF" position.

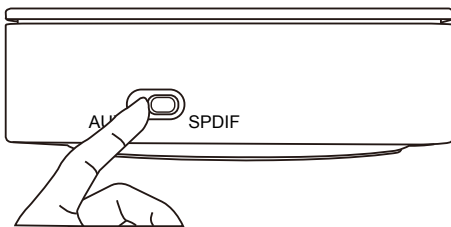

- 2) Ensure your TV Speaker setting is set to "External Speaker".
- 3) **IMPORTANT:** Ensure TV Audio format is set to "PCM" or make sure "DOLBY/DTS" is off.

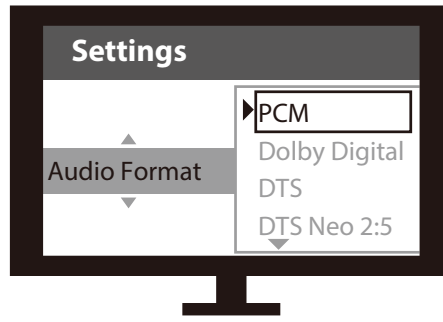
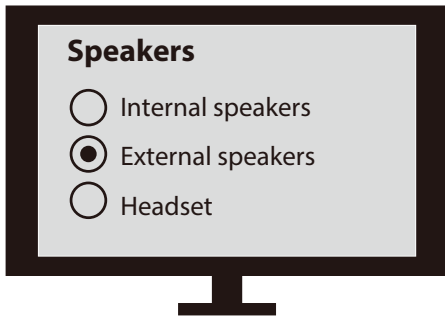

TV with AUX 3.5mm audio out

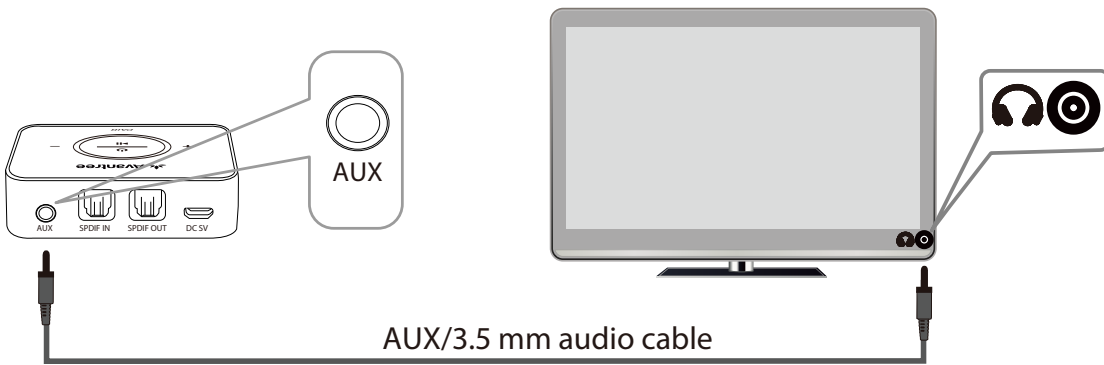

After connecting your audio cable you should be able to hear sound from your headphones; if not:

- 1) Ensure the AUX/SPDIF (Optical) switch on the TC417 is set to the "AUX" position.

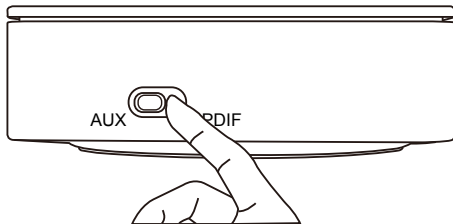

- 2) Ensure your TV speaker setting is set to "Headset".

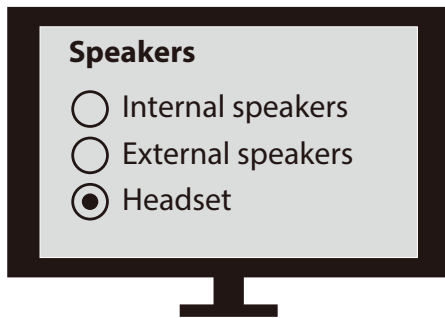

- 3) Plug wired ear buds into the headphone jack on TV; check if you can hear sound.

TV with RCA Audio Out (Red/White ports labeled "AUDIO OUT")

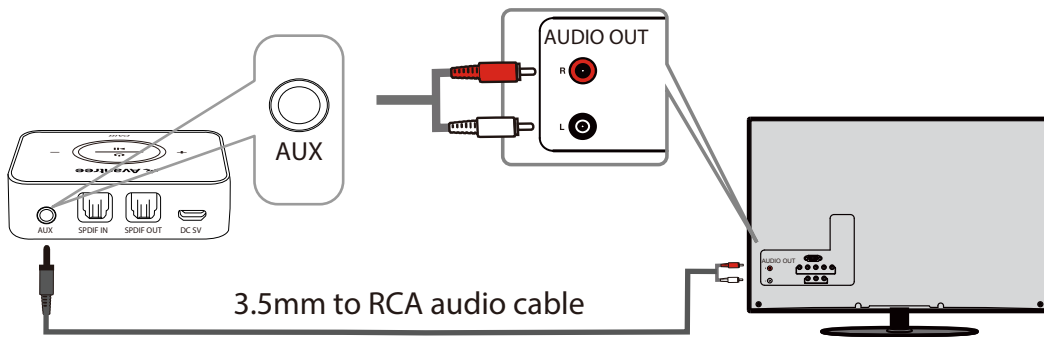

After connecting the cable you should be able to hear sound from your headphones; if not:

1) Ensure the AUX/SPDIF (Optical) switch on the TC417 is set to the "AUX" position.

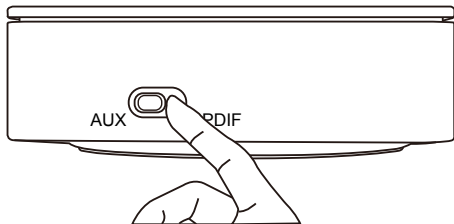

2) Ensure using TV Red/White ports labeled "AUDIO OUT"; other Red/White ports are incorrect.

3) Ensure your TV Speaker setting is set to "External Speaker".

4) Plug headphone into RCA ports with AUX 3.5mm to RCA audio adaptor cable To check if you can hear sound.

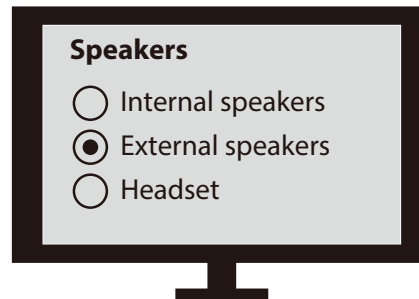
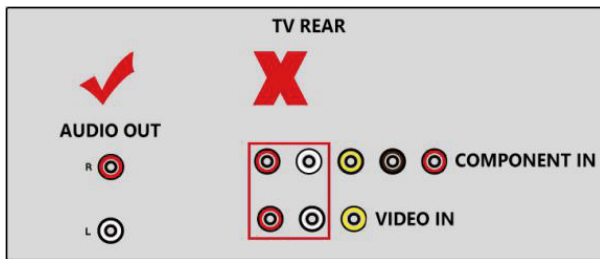

Receiver with 6.35mm Phone Jack at Front

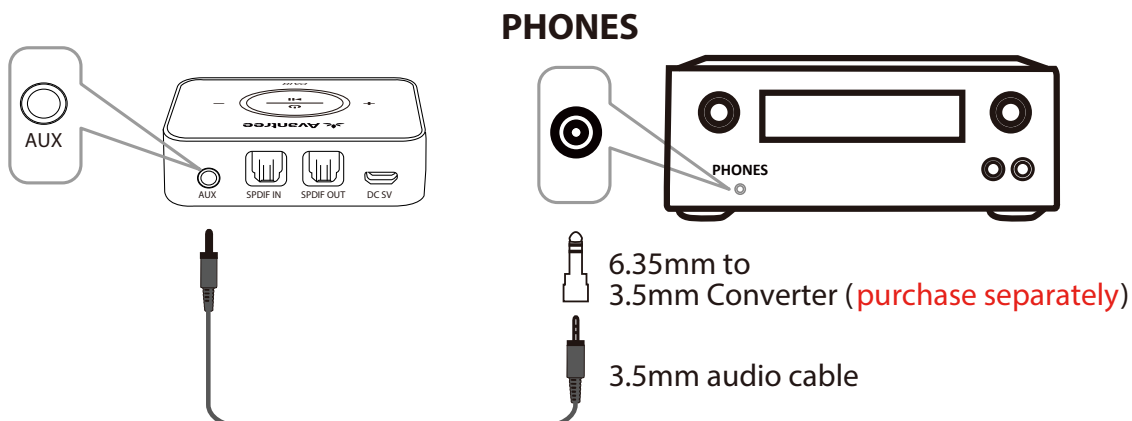

NOTES:

- 1) Transmitter is NOT compatible with ANY RCA (L/R) ports on back of your AV Receiver, ONLY use the BIG 6.35MM PHONE OUT on front side of your AV Receiver with the 6.35mm to 3.5mm adapter.
- 2) Do NOT set the volume too high.
- 3) Plug wired ear buds into the port to check the sound.
- 4) Ensure the AUX/SPDIF(Optical) switch on the TC417 is set to the "AUX" position.

Works as Bluetooth Receiver (RX Mode)

1. **Turn on the TC417:** Press and hold MFB button for 3 seconds until you see the **BLUE** light.

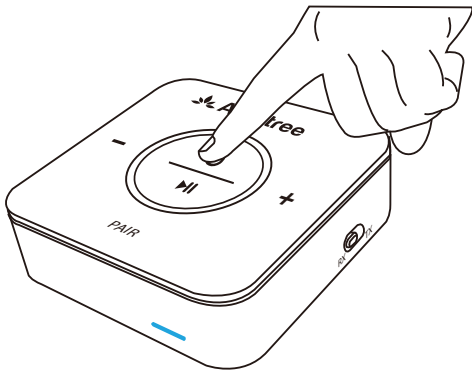

2. **Set the TC417 to RX mode:** Slide TX/RX switch to "RX" position.

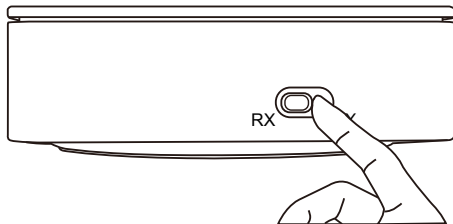

3. **Enter the TC417 into PAIRING MODE:** Upon first use, the TC417 will enter pairing mode automatically. The LED indicator will flash **BLUE** rapidly. Otherwise, press and hold PAIR button for 2 seconds to enter into pairing mode.
4. **Connect the TC417 to Bluetooth audio source:** Activate Bluetooth on your Bluetooth audio source and search for "Avantree TC417" - tap to connect. Once connected, LED on the TC417 will turn **SOLID BLUE**.

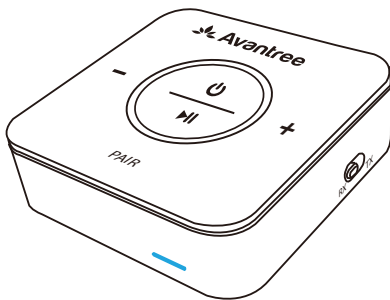

5. **Plug the TC417 to wired speaker or sound bar:**
Optical audio input, refer to **Option A**. If no sound, ensure AUX / SPDIF (Optical) Switch on TC417 is set to "SPDIF" position.

AUX 3.5mm input, refer to **Option B**. If no sound, ensure AUX / SPDIF (Optical) Switch on TC417 is set to "AUX" position.

RCA audio input, refer to **Option C**. If no sound, ensure AUX / SPDIF (Optical) Switch on TC417 is set to "AUX" position.

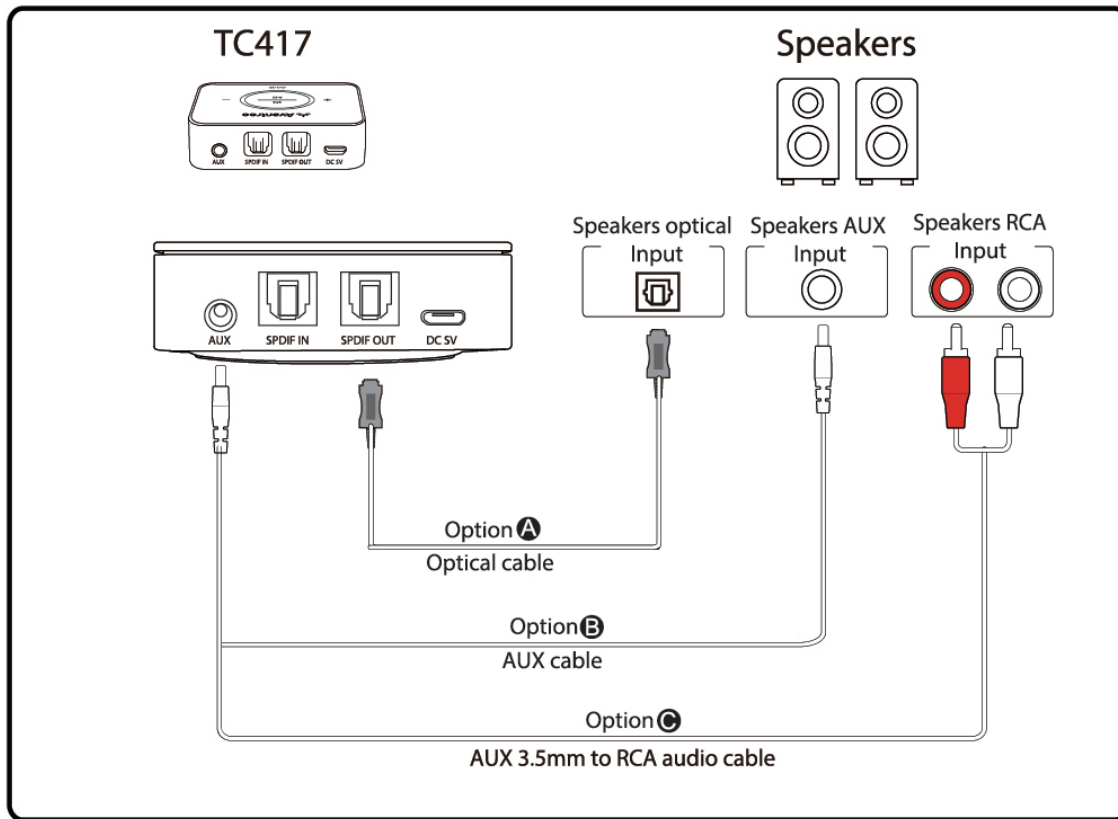

Tips

Charging

When LED flashes **RED** quickly, you need to recharge the TC417. Connect to USB charger that supports 5V/500mA-2A using included Micro USB charging cable. Normally it takes 2 hours to fully charge. Once charge is complete, the **RED** LED will turn off.

Notes:

- 1) The TC417 supports charging during operation. However, if you plug in a USB charger during operation, the TC417 will power off automatically. You will need to turn on TC417 again and it will auto reconnect to the headphones.
- 2) While using the TC417, we do not recommend using a TV USB port for charging as it may cause noise.

After Use

TC417 will automatically power off after disconnected from paired Bluetooth devices for 10 minutes. You can also manually power off – Press and hold MFB button for 3 seconds, LED will turn off.

Clear pairing history

After power on, press and hold PAIR button for 8 seconds until LED indicator flashes **RED** twice. Now all pairing history of TC417 is cleared and the TC417 will enter pairing mode, LED flashes **GREEN** (TX Mode) or **BLUE** (RX Mode) quickly.

Troubleshooting

Not working/no sound

1. Transmitter and Headphones are not connected properly

Turn off and on both headphones and transmitter, they should auto connect to each other, once connected successfully, LED indicator on TC417 turns SOLID **BLUE**.

2. No audio signal going into the transmitter

If connected using OPTICAL port:

- a) Ensure AUX/SPDIF (Optical) Switch on TC417 is set to "SPDIF" position.
- b) Ensure your TV audio format is set to "PCM" or "DOLBY/DTS" is off;
- c) Change your TV audio OUT setting to "External Speaker".

If connected using the RCA ports:

- a) Ensure AUX/SPDIF(Optical) Switch on TC417 is set to "AUX" position.
- b) Ensure you are using the Red/White ports labeled "Audio OUT". Other RCA ports are usually AUDIO IN and incorrect.
- c) Change your TV audio OUT setting to "External Speakers".
- d) Plug a pair of wired headphones into the RCA ports using the AUX 3.5mm to RCA audio cable, check if you can hear sound.

If connected using AUX/3.5mm audio out:

- a) Ensure AUX/SPDIF(Optical) Switch on TC417 is set to "AUX" position.
- b) Change your TV audio OUT setting to "Headset", directly plug headphone into TV with the AUX 3.5mm audio cable, check if you can hear sound.

Short range/audio cuts

Unstable Bluetooth connection – Clear paired history of BOTH the transmitter and headphone.

Wireless signal interference – Other wireless devices in the vicinity of the transmitter may be affecting its range, move the transmitter away from other nearby wireless devices such as an Apple TV, a Chromecast stick, a Roku stick, any other RF audio transmitters etc.

Short range of headphone – Operating range is determined by devices on BOTH ends. Use your cellphone to test whether the range of your headphones is acceptable.

Source issue – When you play an internet source from PC, or cell phone, quite often, the audio cuts are Internet bandwidth / speed related. Please test with non-streamed, local content on your phone and check again.

Audio delay

All Bluetooth devices will work with this Avantree Bluetooth transmitter. aptX Low Latency compliant headphones/speakers (e.g. Avantree Audition Pro), will achieve a negligible 40ms delay (latency), ideal for watching TV/movies. aptX Low Latency certified products:

<https://www.aptx.com/aptx-low-latency>

Non-aptX LL supported headphones/speakers (e.g. Bose, Beats, Sony), will use either the SBC or aptX codec and will experience a 70-220ms latency (may be noticeable by some users).

Noise

Audio source – Plug wired earbuds into your TV or other audio source, check if the sound is normal.

Audio cable – Try a different audio cable for connecting the TC417 and your audio source.

Power supply – If you want to charge the TC417 while it's in use, 1) do not use a TV USB port, try using a separate USB charger 2) if noise persists try using a different charge cable.

Clear paired history – Clear the paired history of BOTH the TC417 and your Bluetooth device.