

# **VEVOR<sup>®</sup>**

**TOUGH TOOLS, HALF PRICE**

Technical Support and E-Warranty Certificate [www.vevor.com/support](http://www.vevor.com/support)

## **RATTAN BOOKSHELVES**

### **USER MANUAL**

**MODEL NO.: HY-BTJ-008**

We continue to be committed to provide you tools with competitive price. "Save Half", "Half Price" or any other similar expressions used by us only represents an estimate of savings you might benefit from buying certain tools with us compared to the major top brands and does not necessarily mean to cover all categories of tools offered by us. You are kindly reminded to verify carefully when you are placing an order with us if you are actually Saving Half in comparison with the top major brands.

# VEVOR®

TOUGH TOOLS, HALF PRICE

## Rattan Bookshelves

MODEL NO.: HY-BTJ-008

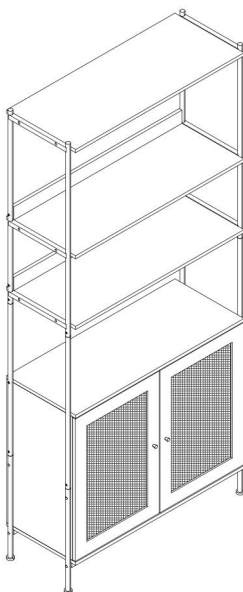

### NEED HELP? CONTACT US!

Have product questions? Need technical support? Please feel free to contact us:

**Technical Support and E-Warranty Certificate**  
**[www.vevor.com/support](http://www.vevor.com/support)**

This is the original instruction, please read all manual instructions carefully before operating. VEVOR reserves a clear interpretation of our user manual. The appearance of the product shall be subject to the product you received. Please forgive us that we won't inform you again if there are any technology or software updates on our product.

## **WARNING:**

**Please read this manual carefully before using the product. Failure to do so may result in serious injury.**



Please read and observe carefully all the assembly instructions before beginning assembly.

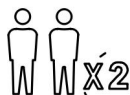

Unit should be assembled by two or more people.



**DO NOT CLIMB**

Please do not let your child climb on the product. If you have kids or animals who like to climb, we highly recommend using the wall anchors and brackets/straps that come with the package.

## **ASSEMBLY PRECAUTIONS**

1. Assemble only according to these instructions. Improper assembly can create hazards.
2. Wear ANSI-approved safety goggles and heavy-duty work gloves during assembly.
3. Keep the assembly area clean and well-lit.
4. Keep bystanders out of the area during assembly.
5. Do not assemble when tired or when under the influence of alcohol, drugs or medication.
6. The product capabilities apply to properly and completely assembled products only.

7. Assemble on a flat, level, hard and smooth surface capable of safely supporting the Rattan Bookshelves.

8. For additional information regarding the parts listed in the following pages, please refer to the Assembly Diagram of this manual. Unwrap and separate all parts in a clean work area.

SAVE THESE INSTRUCTIONS

## USE PRECAUTIONS

### TO PREVENT SERIOUS INJURY AND DEATH FROM TIPPING:

1. This product is not a toy Do not allow children to play with or near this item.

2. Do not exceed weight capacities, before moving.

3. Use only on a flat, hard and smooth surface capable of safely supporting a fully loaded Rattan Bookshelves.

4. Use as intended only.

Inspect before every use; do not use if parts are loose or damaged.

## TECHNICAL SPECIFICATIONS







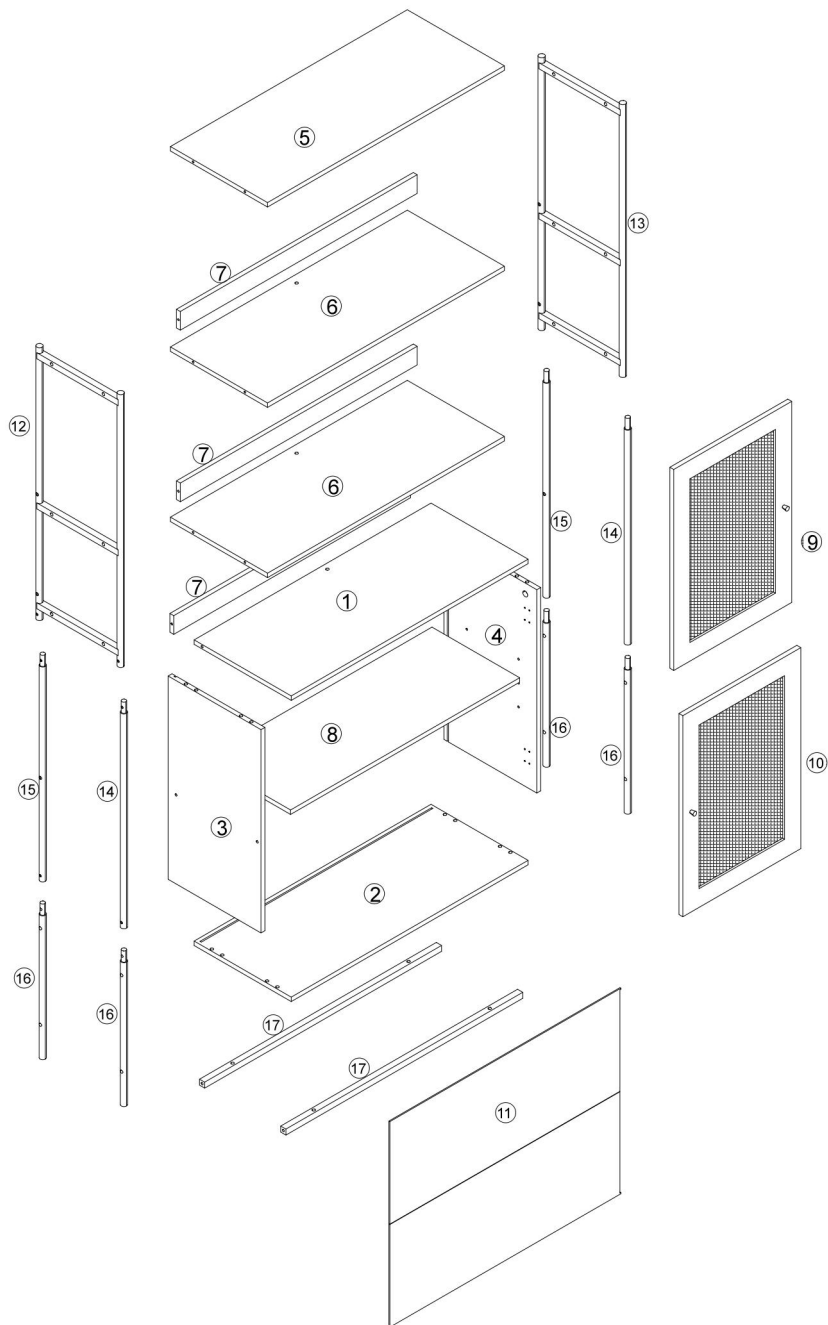

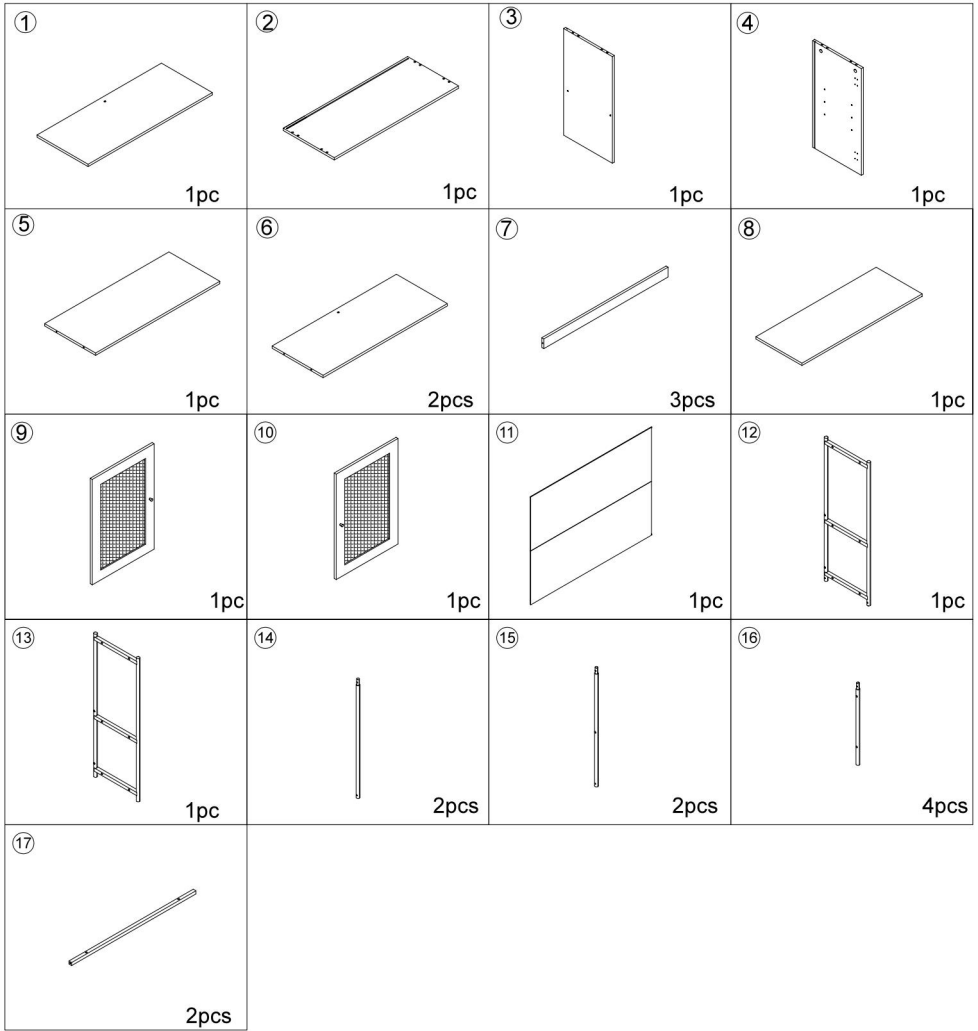









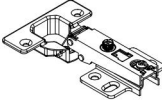

Model	HY-BTJ-008
Product Dimensions (LxWxH)(mm)	764*300*1747
Net Weight(kg)	About 21

\*Products such as specifications, appearance, and design are subject to modification without prior notice.

# PACKAGE CONTENTS

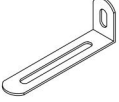







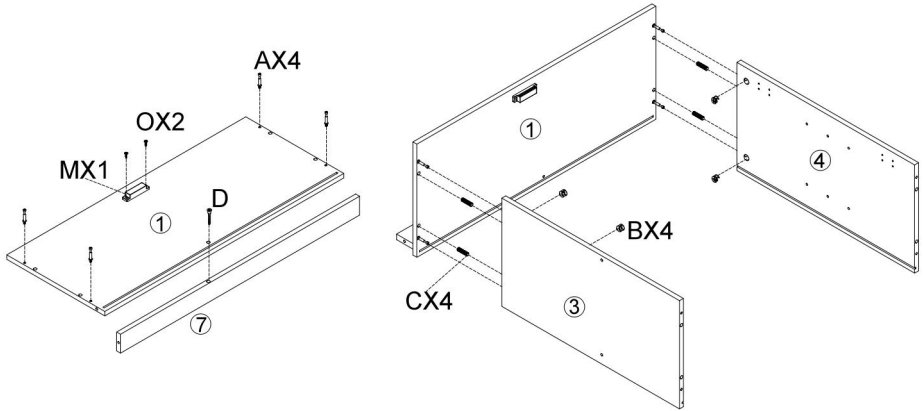

<p><b>A</b></p>  <p>4pcs</p>	<p><b>B</b></p>  <p>4pcs</p>	<p><b>C</b></p>  <p>8pcs</p>	<p><b>D</b></p>  <p>7pcs+1pc</p>
<p><b>E</b></p>  <p>6*25mm 8pcs+1pc</p>	<p><b>F</b></p>  <p>6*40mm 4pcs</p>	<p><b>G</b></p>  <p>6*10mm 8pcs+1pc</p>	<p><b>H</b></p>  <p>18pcs+1pc</p>
<p><b>I</b></p>  <p>4pcs</p>	<p><b>J</b></p>  <p>3.5*12mm 29pcs+2pcs</p>	<p><b>K</b></p>  <p>2pcs</p>	<p><b>L</b></p>  <p>2pcs</p>
<p><b>M</b></p>  <p>1pc</p>	<p><b>N</b></p>  <p>2pcs</p>	<p><b>O</b></p>  <p>3*14mm 2pcs</p>	<p><b>P</b></p>  <p>4pcs</p>
<p><b>Q</b></p>  <p>1pc</p>	<p><b>R</b></p>  <p>1pc</p>	<p><b>S</b></p>  <p>4*30mm 1pc</p>	<p><b>T</b></p>  <p>4pcs</p>

# ASSEMBLY STEPS

## STEP : 1



D	B	C	A	M	O
					
1pc	4pcs	4pcs	4pcs	1pc	3*14mm 2pcs

## STEP : 2

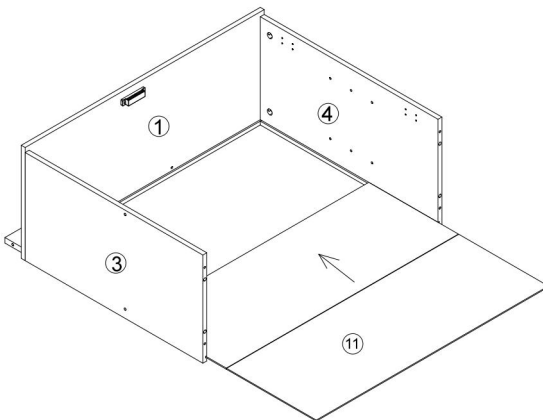

# STEP : 3

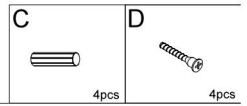
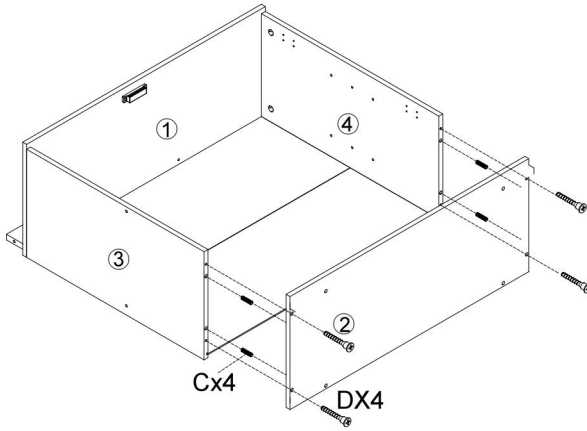

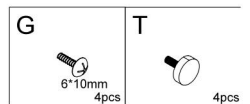
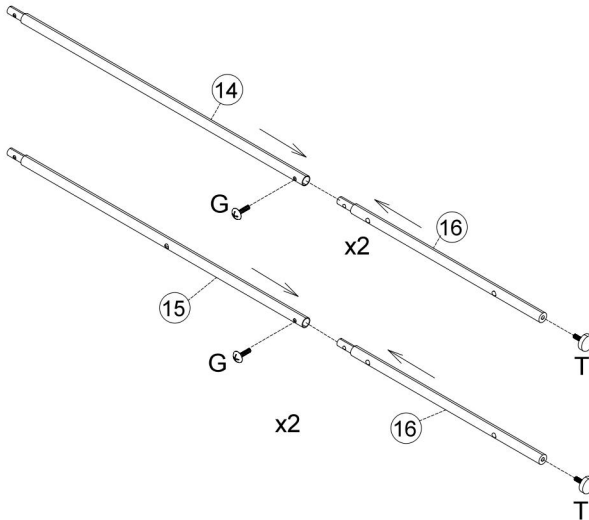

# STEP : 4



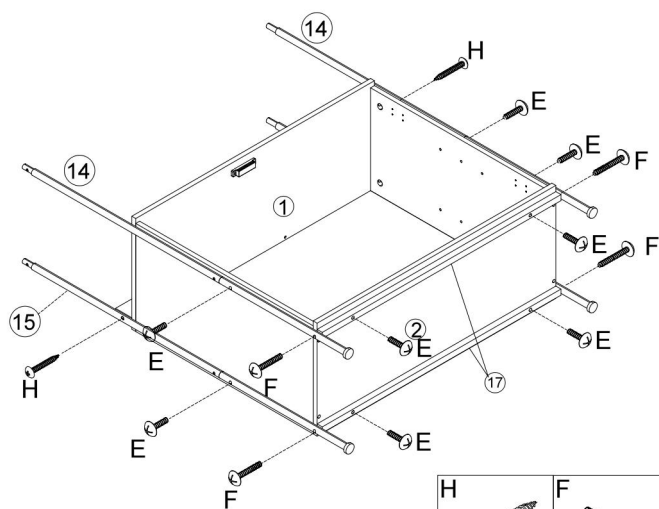



# STEP : 5

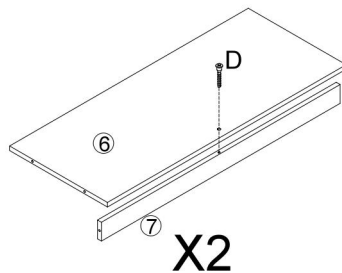
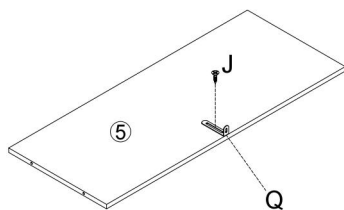

<p><b>H</b></p>  <p>2pcs</p>	<p><b>F</b></p>  <p>6*40mm 4pcs</p>	<p><b>E</b></p>  <p>6*25mm 8pcs</p>
---------------------------------------------------------------------------------------------------------------	--------------------------------------------------------------------------------------------------------------------------	---------------------------------------------------------------------------------------------------------------------------

# STEP : 6



<p><b>D</b></p>  <p>2pcs</p>	<p><b>J</b></p>  <p>3.5*12mm 1pc</p>	<p><b>Q</b></p>  <p>1pc</p>
-----------------------------------------------------------------------------------------------------------------	-----------------------------------------------------------------------------------------------------------------------------	-----------------------------------------------------------------------------------------------------------------

# STEP : 7

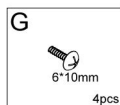
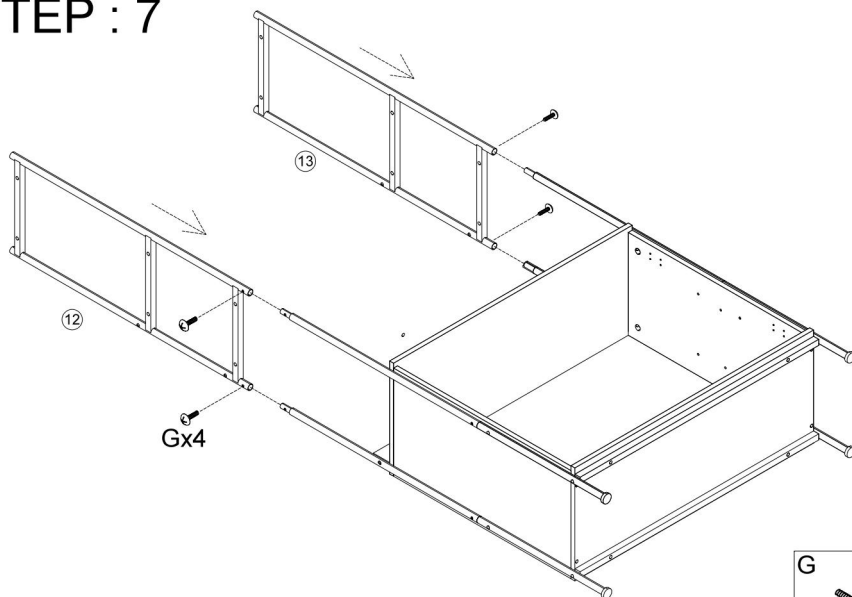

# STEP : 8

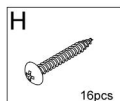
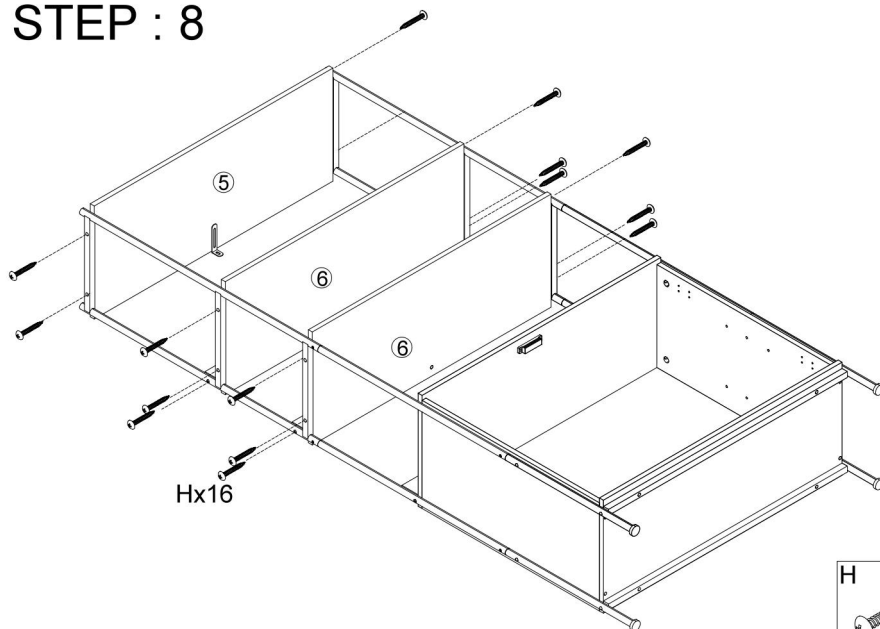

# STEP : 9

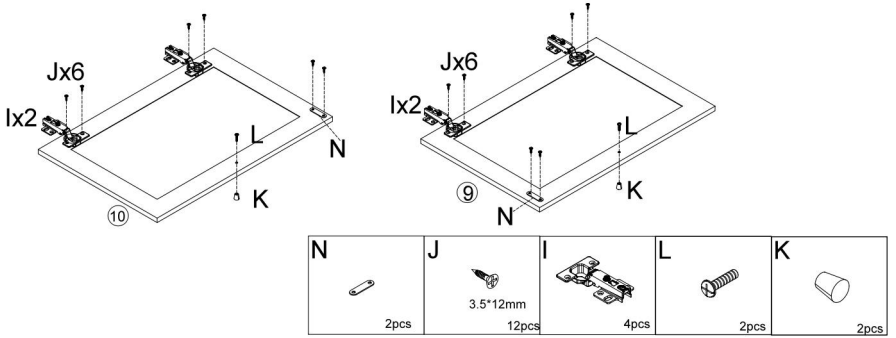

# STEP : 10

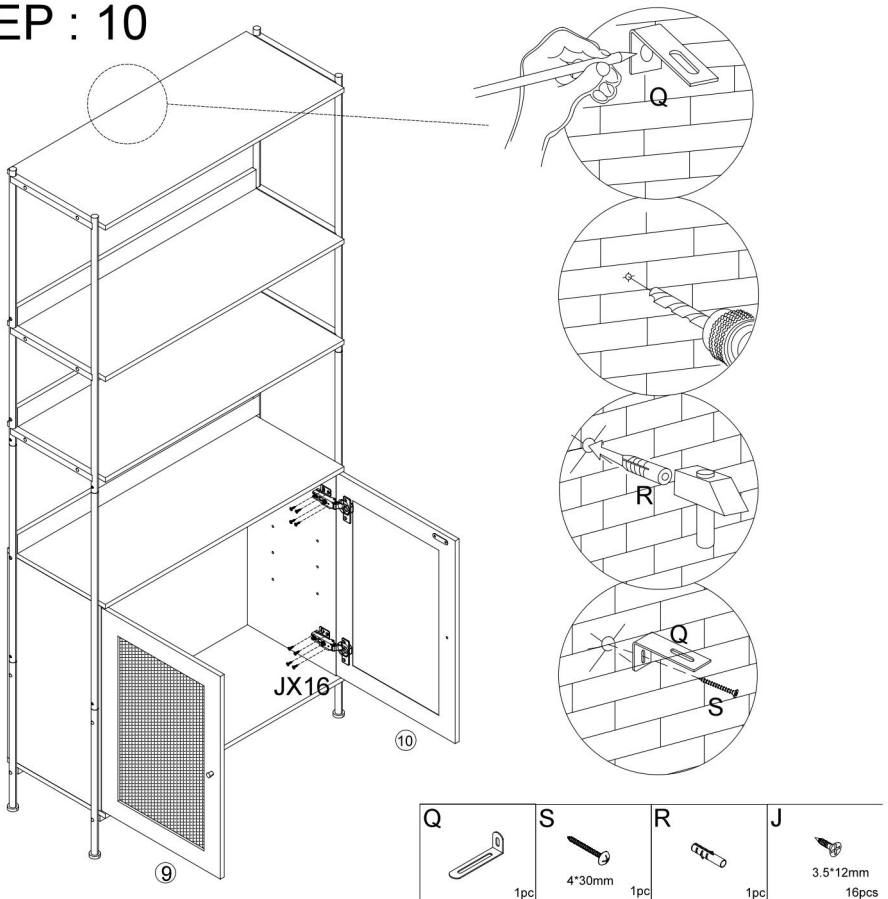

# STEP : 11

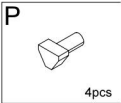
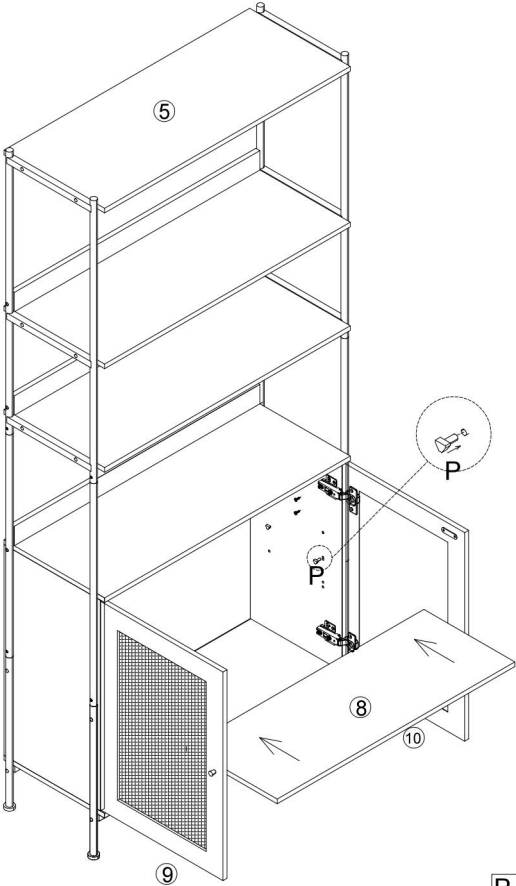

## COMPLETION

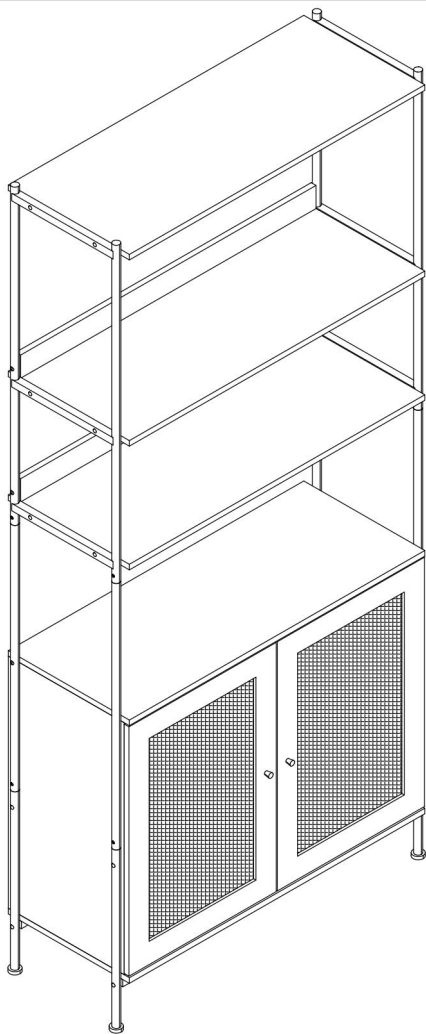

## WARNING



Children have died from furniture tipover. To reduce the risk of furniture tipover:

- ALWAYS install tipover restraint provided.
- NEVER put a TV on this product.
- NEVER allow children to stand, climb or hang on drawers, doors, or shelves.
- NEVER open more than one drawer at a time.
- Place heaviest items in the lowest drawers.

**Manufacturer:** Shanghaimuxinmuyeyouxiangongsi

**Address:** Shuangchenglu 803nong11hao1602A-1609shi, baoshanqu, shanghai 200000 CN.

**Imported to AUS:** SIHAO PTY LTD. 1 ROKEVA STREETEASTWOOD NSW 2122 Australia

**Imported to USA:** Sanven Technology Ltd. Suite 250, 9166 Anaheim Place, Rancho Cucamonga, CA 91730

<b>EC</b>	<b>REP</b>
-----------	------------

E-CrossStu GmbH  
Mainzer Landstr.69, 60329 Frankfurt am Main.

<b>UK</b>	<b>REP</b>
-----------	------------

YH CONSULTING LIMITED.  
C/O YH Consulting Limited Office 147, Centurion House, London Road, Staines-upon-Thames, Surrey, TW18 4AX

# VEVOR<sup>®</sup>

**TOUGH TOOLS, HALF PRICE**

**Technical Support and E-Warranty Certificate**

[www.vevor.com/support](http://www.vevor.com/support)

# VEVOR®

**TOUGH TOOLS, HALF PRICE**

Technique Certificat d'assistance et de garantie électronique

[www.vevor.com/support](http://www.vevor.com/support)

## **BIBLIOTHÈQUE EN ROTIN MANUEL D' UTILISATION**

**MODÈLE N° : HY-BTJ-008**

Nous continuons à nous engager à vous fournir des outils à des prix compétitifs. « Économisez la moitié », « Moitié prix » ou toute autre expression similaire utilisée par nous uniquement représente une estimation des économies dont vous pourriez bénéficier en achetant certains outils avec nous par rapport aux grandes marques et ne signifie pas nécessairement couverture toutes les catégories d'outils que nous proposons. Nous vous rappelons de bien vouloir vérifier soigneusement lorsque vous passez une commande chez nous si vous êtes réellement Économie

Moitié par rapport aux plus grandes marques.

# VEVOR®

TOUGH TOOLS, HALF PRICE

## Rattan Bookshelves

MODÈLE N° : HY-BTJ-008

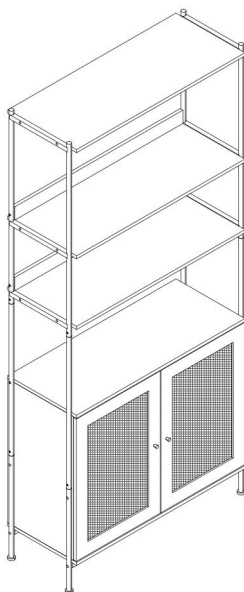

### BESOIN D'AIDE? CONTACTEZ-NOUS!

Vous avez des questions sur nos produits ? Vous avez besoin d'une assistance technique ? N'hésitez pas à nous contacter :

**Assistance technique et certificat de garantie électronique**

**[www.vevor.com/support](http://www.vevor.com/support)**

Il s'agit de la notice d'utilisation d'origine. Veuillez lire attentivement toutes les instructions du manuel avant de l'utiliser. VEVOR se réserve le droit d'interpréter clairement notre manuel d'utilisation. L'apparence du produit dépend du produit que vous avez reçu. Veuillez nous excuser, nous ne vous informerons plus si des mises à jour technologiques ou logicielles sont disponibles sur notre produit.

## AVERTISSEMENT:

**Veillez lire attentivement ce manuel avant d'utiliser le produit. Le non-respect de ces instructions peut entraîner des blessures graves.**



Please read and observe carefully all the assembly instructions before beginning assembly.



Unit should be assembled by two or more people.



DO NOT CLIMB

Please do not let your child climb on the product. If you have kids or animals who like to climb, we highly recommend using the wall anchors and brackets/straps that come with the package.

## PRÉCAUTIONS D'ASSEMBLAGE

9. Assembler uniquement selon ces instructions. Un assemblage incorrect peut créer des dangers.
10. Portez des lunettes de sécurité approuvées ANSI et des gants de travail robustes pendant l'assemblage.
11. Gardez la zone de montage propre et bien éclairée.
12. Gardez les spectateurs hors de la zone pendant le montage.
13. Ne pas monter si vous êtes fatigué ou sous l'influence de l'alcool, de drogues ou de médicaments.

14. Les capacités du produit s'appliquent uniquement aux produits correctement et entièrement assemblés.

15. Assemblez-les sur une surface plane, de niveau, dure et lisse capable de supporter en toute sécurité les étagères en rotin.

16. Pour plus d'informations sur les pièces répertoriées dans les pages suivantes, reportez-vous au schéma d'assemblage de ce manuel.

Déballer et séparer toutes les pièces dans un espace de travail propre.

CONSERVEZ CES INSTRUCTIONS

## PRÉCAUTIONS D'EMPLOI

**POUR ÉVITER LES BLESSURES GRAVES ET LA MORT RÉSULTANT DU BASCULEMENT :**

5. Ce produit n'est pas un jouet. Ne laissez pas les enfants jouer avec ou à proximité de cet article.

6. Ne pas dépasser les capacités de poids avant de déménager.

7. Utiliser uniquement sur une surface plane, dure et lisse capable de supporter en toute sécurité une étagère en rotin entièrement chargée.

8. Utiliser uniquement comme prévu.

Inspectez avant chaque utilisation ; ne pas utiliser si des pièces sont desserrées ou endommagées.

### TECHNICAL SPECIFICATIONS

Modèle	HY-BTJ-008
Dimensions du produit (L x l x H) (mm)	764*300*1747







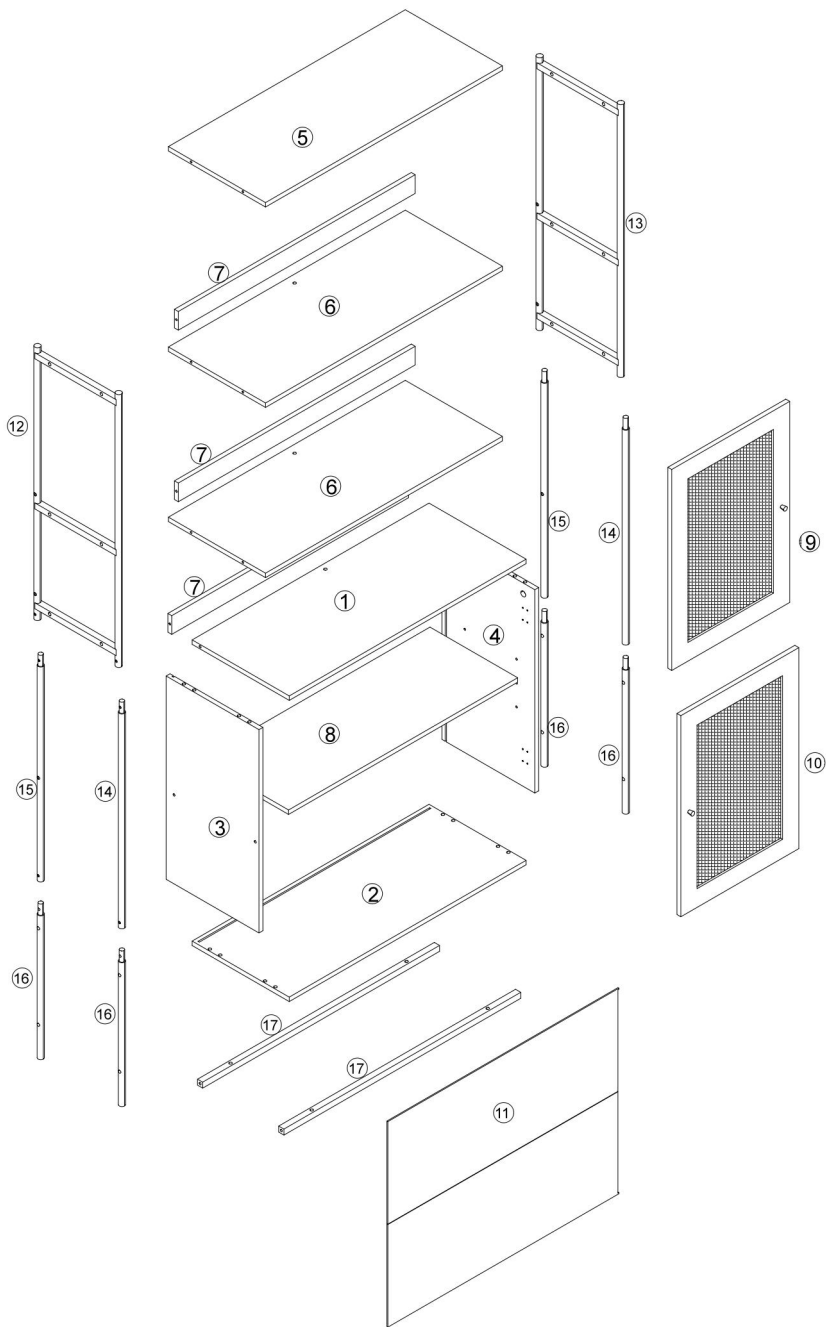

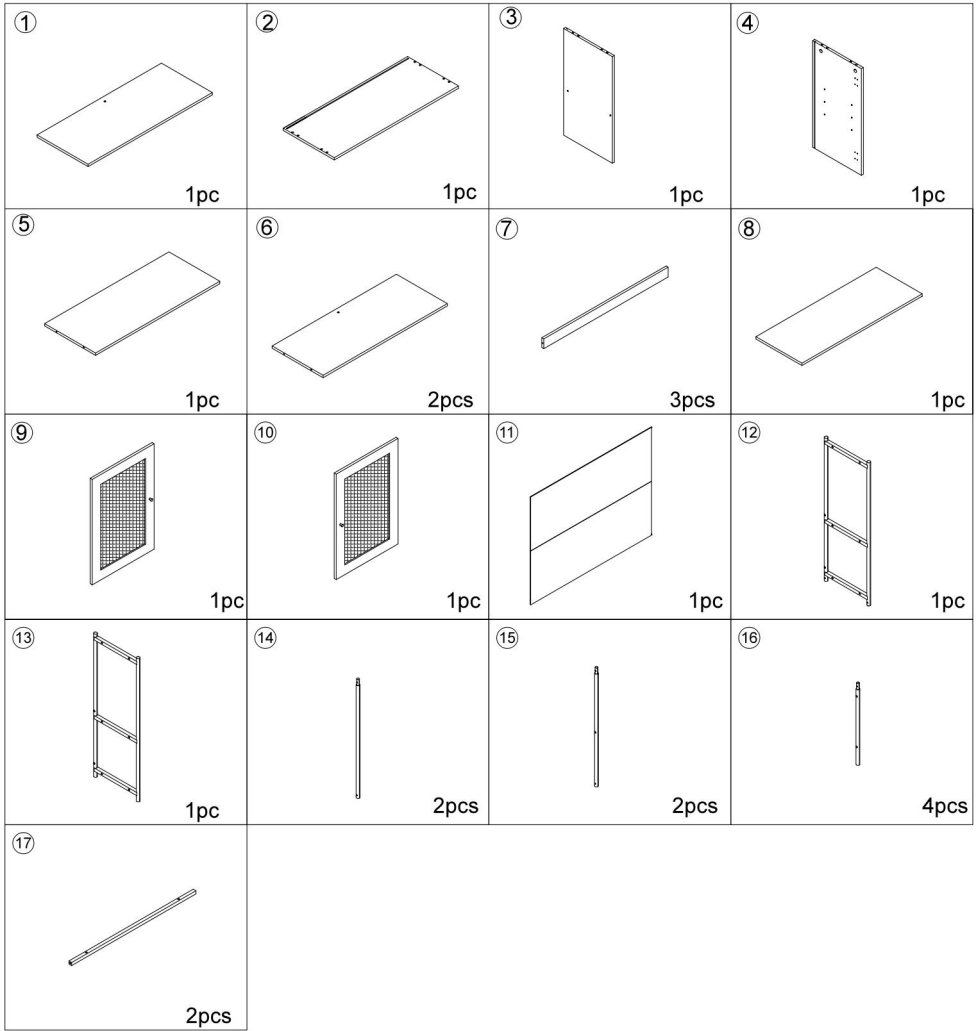









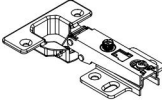

Poids net (kg)	Environ 21
----------------	------------

\*Les produits tels que les spécifications, l'apparence et la conception sont sujets à modification sans préavis.

## **PACKAGE CONTENTS**

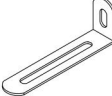







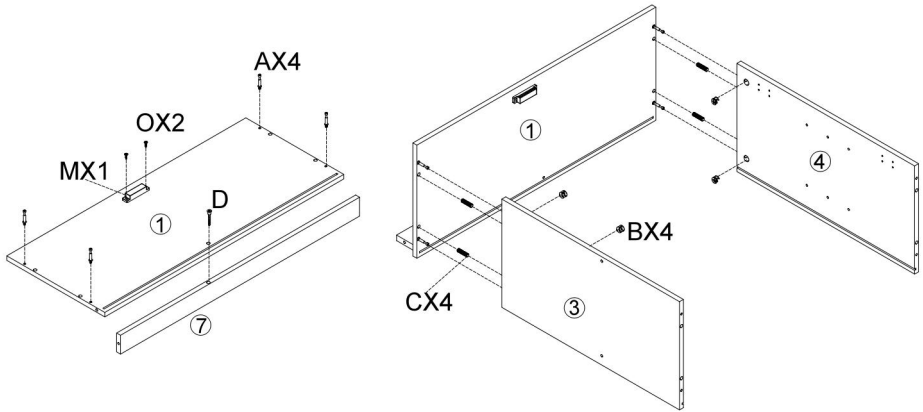

<p><b>A</b></p>  <p>4pcs</p>	<p><b>B</b></p>  <p>4pcs</p>	<p><b>C</b></p>  <p>8pcs</p>	<p><b>D</b></p>  <p>7pcs+1pc</p>
<p><b>E</b></p>  <p>6*25mm 8pcs+1pc</p>	<p><b>F</b></p>  <p>6*40mm 4pcs</p>	<p><b>G</b></p>  <p>6*10mm 8pcs+1pc</p>	<p><b>H</b></p>  <p>18pcs+1pc</p>
<p><b>I</b></p>  <p>4pcs</p>	<p><b>J</b></p>  <p>3.5*12mm 29pcs+2pcs</p>	<p><b>K</b></p>  <p>2pcs</p>	<p><b>L</b></p>  <p>2pcs</p>
<p><b>M</b></p>  <p>1pc</p>	<p><b>N</b></p>  <p>2pcs</p>	<p><b>O</b></p>  <p>3*14mm 2pcs</p>	<p><b>P</b></p>  <p>4pcs</p>
<p><b>Q</b></p>  <p>1pc</p>	<p><b>R</b></p>  <p>1pc</p>	<p><b>S</b></p>  <p>4*30mm 1pc</p>	<p><b>T</b></p>  <p>4pcs</p>

# ASSEMBLY STEPS

## STEP : 1



D	B	C	A	M	O
					
1pc	4pcs	4pcs	4pcs	1pc	3*14mm 2pcs

## STEP : 2

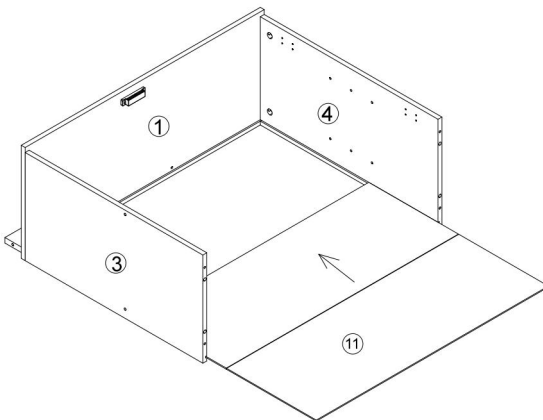

# STEP : 3

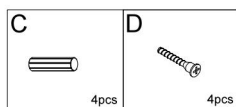
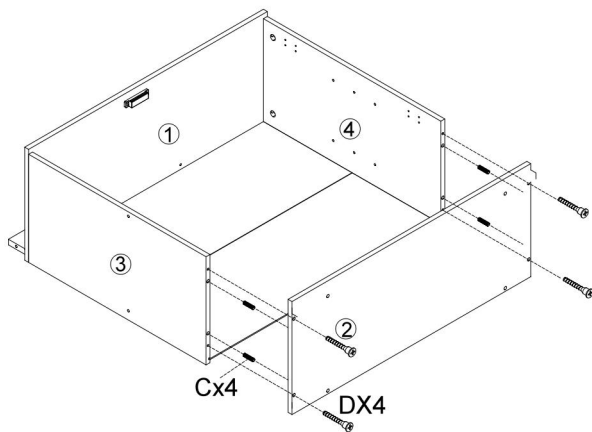

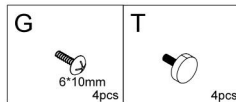
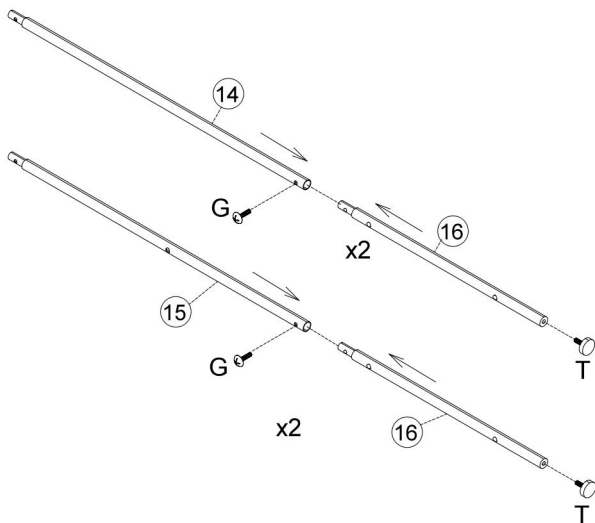

# STEP : 4



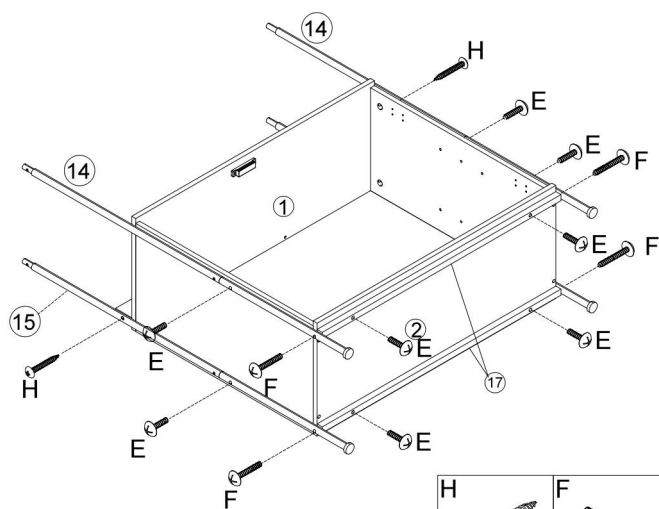



# STEP : 5

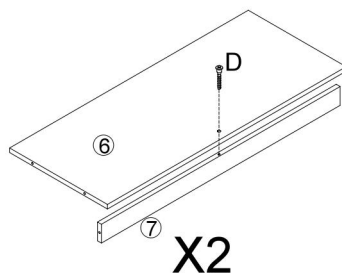
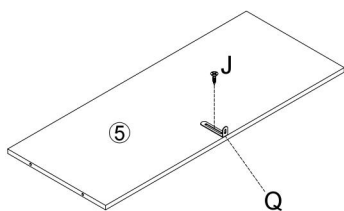

<p><b>H</b></p>  <p>2pcs</p>	<p><b>F</b></p>  <p>6*40mm 4pcs</p>	<p><b>E</b></p>  <p>6*25mm 8pcs</p>
---------------------------------------------------------------------------------------------------------------	--------------------------------------------------------------------------------------------------------------------------	---------------------------------------------------------------------------------------------------------------------------

# STEP : 6



<p><b>D</b></p>  <p>2pcs</p>	<p><b>J</b></p>  <p>3.5*12mm 1pc</p>	<p><b>Q</b></p>  <p>1pc</p>
-----------------------------------------------------------------------------------------------------------------	-----------------------------------------------------------------------------------------------------------------------------	-----------------------------------------------------------------------------------------------------------------

# STEP : 7

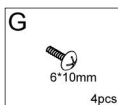
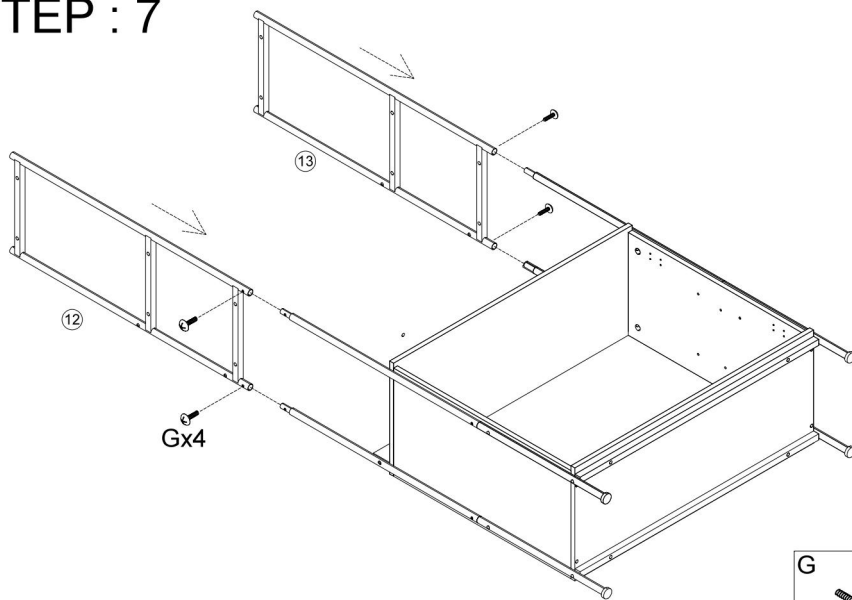

# STEP : 8

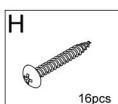
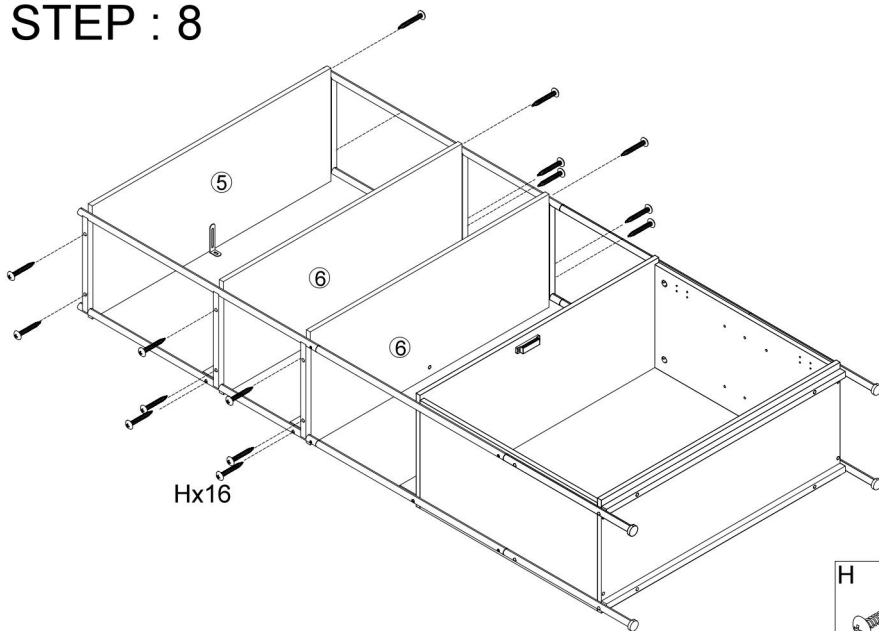

# STEP : 9

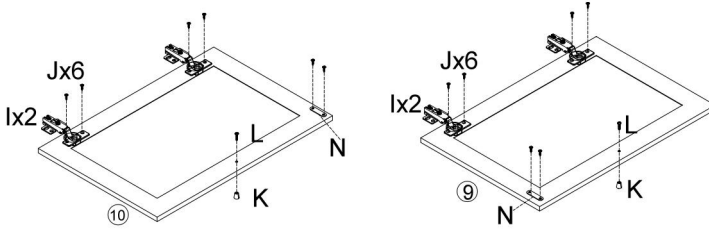

N	J	I	L	K
2pcs	12pcs 3.5*12mm	4pcs	2pcs	2pcs

# STEP : 10

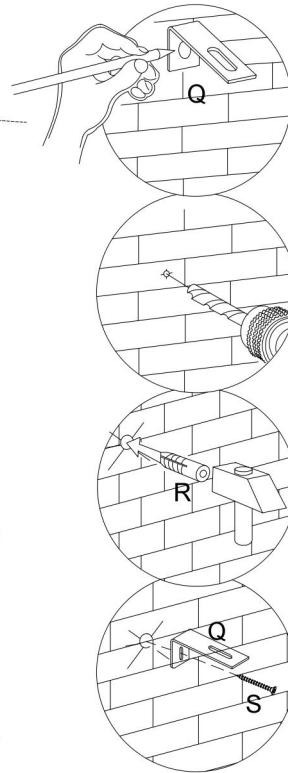
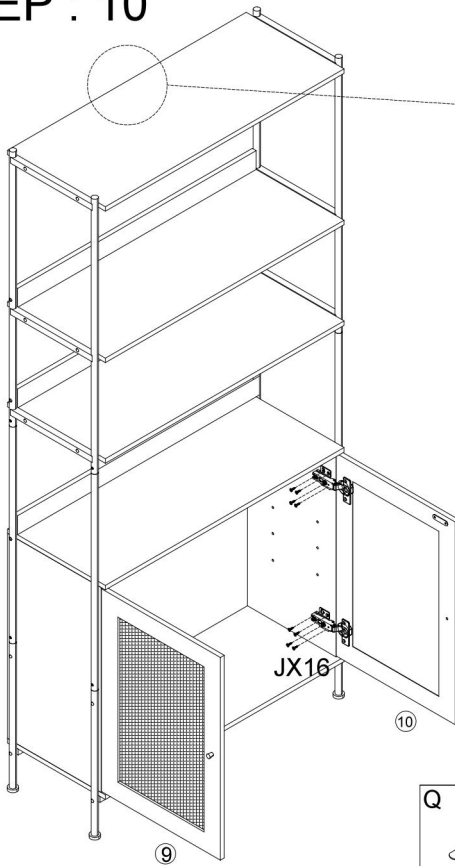

Q	S	R	J
1pc	16pcs 4*30mm	1pc	1pc 3.5*12mm

# STEP : 11

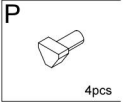
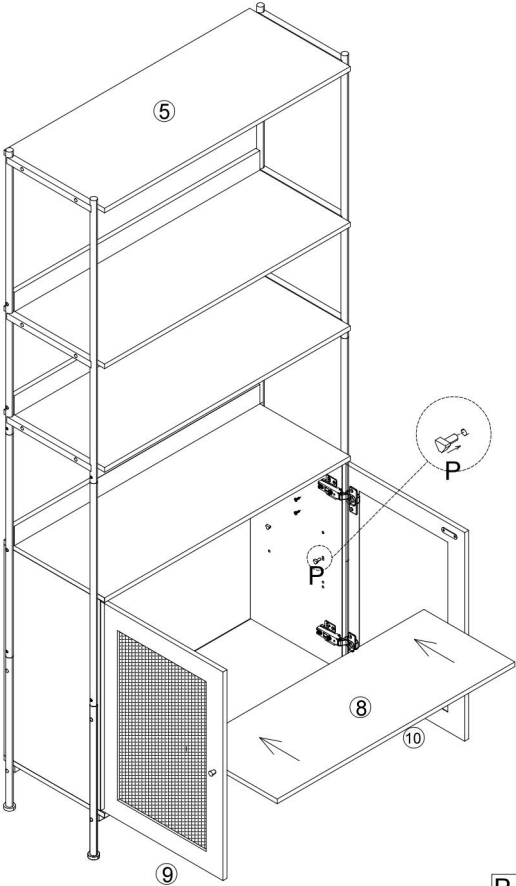

## COMPLETION

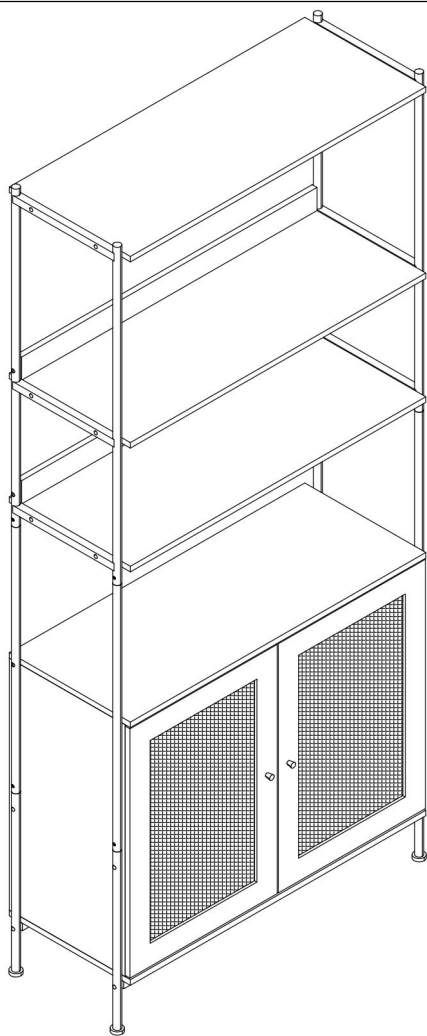

## WARNING



Children have died from furniture tipover. To reduce the risk of furniture tipover:

- ALWAYS install tipover restraint provided.
- NEVER put a TV on this product.
- NEVER allow children to stand, climb or hang on drawers, doors, or shelves.
- NEVER open more than one drawer at a time.
- Place heaviest items in the lowest drawers.

**Fabricant** : Shanghaimuxinmuyeyouxiangongsi

**Adresse** : Shuangchenglu 803nong11hao1602A-1609shi, baoshanqu, shanghai 200000 CN.

**Importé en Australie** : SIHAO PTY LTD. 1 ROKEVA  
STREETEASTWOOD NSW 2122 Australie

**Importé aux États-Unis** : Sanven Technology Ltd. Suite 250, 9166  
Anaheim Place, Rancho Cucamonga, CA 91730

<b>EC</b>	<b>REP</b>
-----------	------------

E-CrossStu GmbH  
Mainzer Landstr.69, 60329 Frankfurt am Main.

<b>UK</b>	<b>REP</b>
-----------	------------

YH CONSULTING LIMITED.  
C/O YH Consulting Limited Office 147, Centurion  
House, London Road, Staines-upon-Thames, Surrey,  
TW18 4AX

# VEVOR®

**TOUGH TOOLS, HALF PRICE**

**Technique Certificat d'assistance et de garantie électronique**

**[www.vevor.com/support](http://www.vevor.com/support)**

# **VEVOR<sup>®</sup>**

**TOUGH TOOLS, HALF PRICE**

Technisch Support und E-Garantie-Zertifikat [www.vevor.com/support](http://www.vevor.com/support)

## **RATTAN-BÜCHERREGALE**

### **BENUTZERHANDBUCH**

**MODELL NR.: HY-BTJ-008**

Wir sind weiterhin bestrebt, Ihnen Werkzeuge zu wettbewerbsfähigen Preisen anzubieten.  
"Sparen Sie die Hälfte", "Halber Preis" oder andere ähnliche Ausdrücke, die wir nur verwenden

stellt eine Schätzung der Einsparungen dar, die Sie durch den Kauf bestimmter Werkzeuge erzielen können

mit uns im Vergleich zu den großen Top-Marken und bedeutet nicht unbedingt, Abdeckung alle von uns angebotenen Werkzeugkategorien. Wir möchten Sie bitten, zu überprüfen sorgfältig

wenn Sie bei uns eine Bestellung aufgeben, wenn Sie tatsächlich Speichern

Hälfte im Vergleich mit den Top-Großmarken.

# VEVOR®

TOUGH TOOLS, HALF PRICE

## Rattan Bookshelves

MODELL NR.: HY-BTJ-008

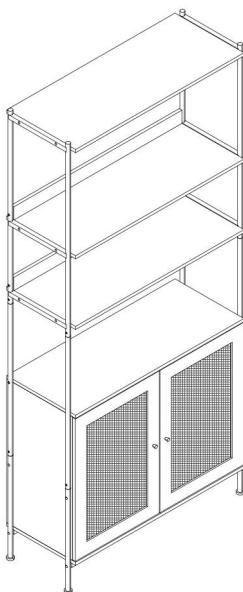

### **Brauchen Sie Hilfe? Kontaktieren Sie uns!**

Sie haben Fragen zu unseren Produkten? Sie benötigen technischen Support? Dann kontaktieren Sie uns gerne:

**Technischer Support und E-Garantie-Zertifikat**

**[www.vevor.com/support](http://www.vevor.com/support)**

Dies ist die Originalanleitung. Bitte lesen Sie alle Anweisungen sorgfältig durch, bevor Sie das Gerät in Betrieb nehmen. VEVOR behält sich eine klare Auslegung unserer Bedienungsanleitung vor. Das Erscheinungsbild des Produkts richtet sich nach dem Produkt, das Sie erhalten haben. Bitte verzeihen Sie uns, dass wir Sie nicht erneut informieren, wenn es Technologie- oder Software-Updates für unser Produkt gibt .

## **WARNUNG:**

**Bitte lesen Sie dieses Handbuch vor der Verwendung des Produkts sorgfältig durch. Andernfalls kann es zu schweren Verletzungen kommen.**



Please read and observe carefully all the assembly instructions before beginning assembly.

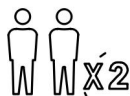

Unit should be assembled by two or more people.



**DO NOT CLIMB**

Please do not let your child climb on the product. If you have kids or animals who like to climb, we highly recommend using the wall anchors and brackets/straps that come with the package.

# **VORSICHTSMASSNAHMEN BEI DER MONTAGE**

17. Führen Sie die Montage nur gemäß dieser Anleitung durch. Eine unsachgemäße Montage kann zu Gefahren führen.
18. Tragen Sie während der Montage eine ANSI-geprüfte Schutzbrille und robuste Arbeitshandschuhe.
19. Halten Sie den Versammlungsbereich sauber und gut beleuchtet.
20. Halten Sie während der Montage unbeteiligte Zuschauer vom Bereich fern.
21. Nicht zusammenbauen, wenn Sie müde sind oder unter dem Einfluss

von Alkohol, Drogen oder Medikamenten stehen.

22. Die Produktfunktionen gelten nur für ordnungsgemäß und vollständig montierte Produkte.

23. Montieren Sie es auf einer flachen, ebenen, harten und glatten Oberfläche, auf der die Rattan-Bücherregale sicher stehen können.

24. Weitere Informationen zu den auf den folgenden Seiten aufgeführten Teilen finden Sie im Montagediagramm dieses Handbuchs. Packen Sie alle Teile in einem sauberen Arbeitsbereich aus und trennen Sie sie.

BEWAHREN SIE DIESE ANLEITUNG AUF

## **VORSICHTSMASSNAHMEN BEIM GEBRAUCH**

**UM SCHWERE VERLETZUNGEN UND TOD DURCH KIPPEN ZU VERMEIDEN:**

9. Dieses Produkt ist kein Spielzeug. Erlauben Sie Kindern nicht, mit diesem Artikel oder in seiner Nähe zu spielen.

10. Überschreiten Sie vor dem Bewegen nicht die Gewichtskapazität.

11. Nur auf einer flachen, harten und glatten Oberfläche verwenden, die ein voll beladenes Rattan-Bücherregal sicher tragen kann.

12. Nur bestimmungsgemäß verwenden.

Vor jedem Gebrauch prüfen; nicht verwenden, wenn Teile lose oder beschädigt sind.

### **TECHNICAL SPECIFICATIONS**







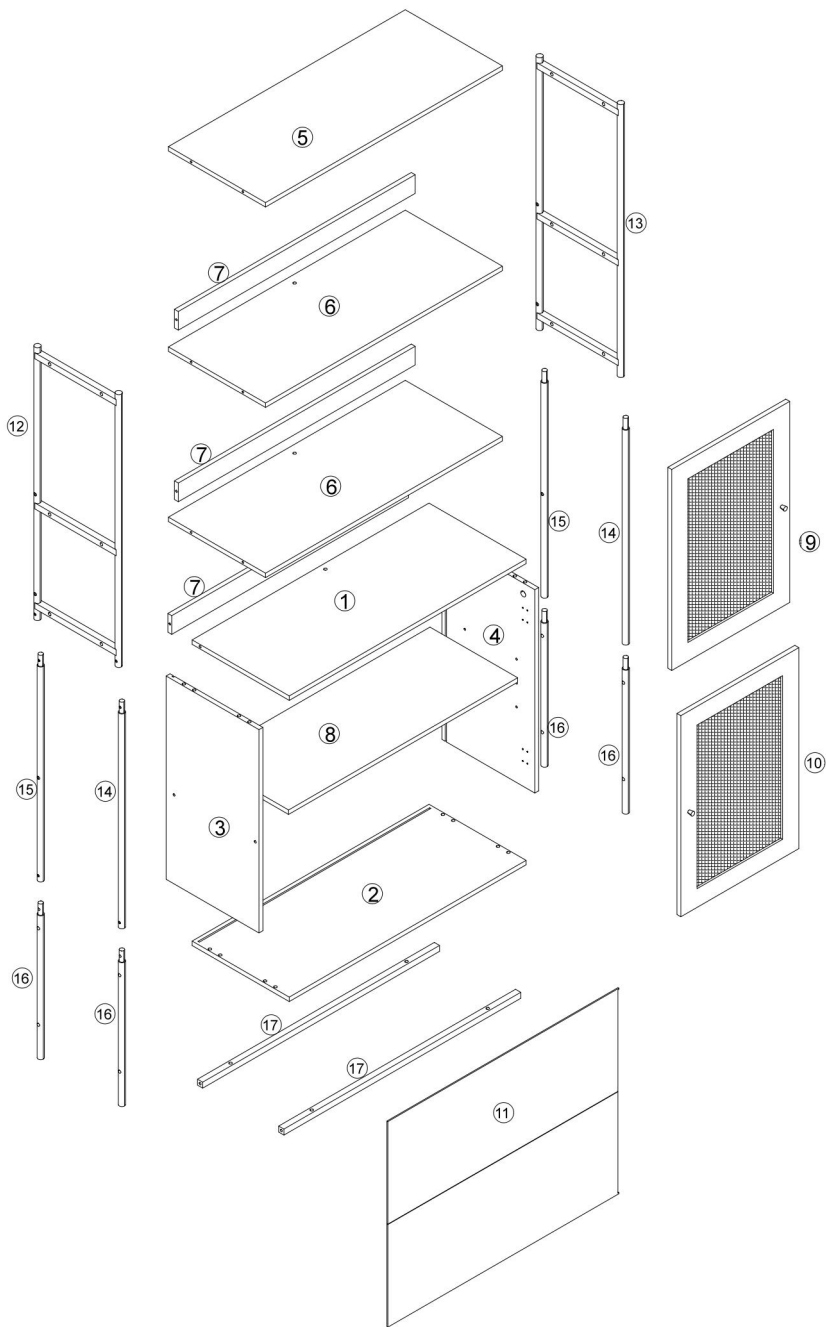

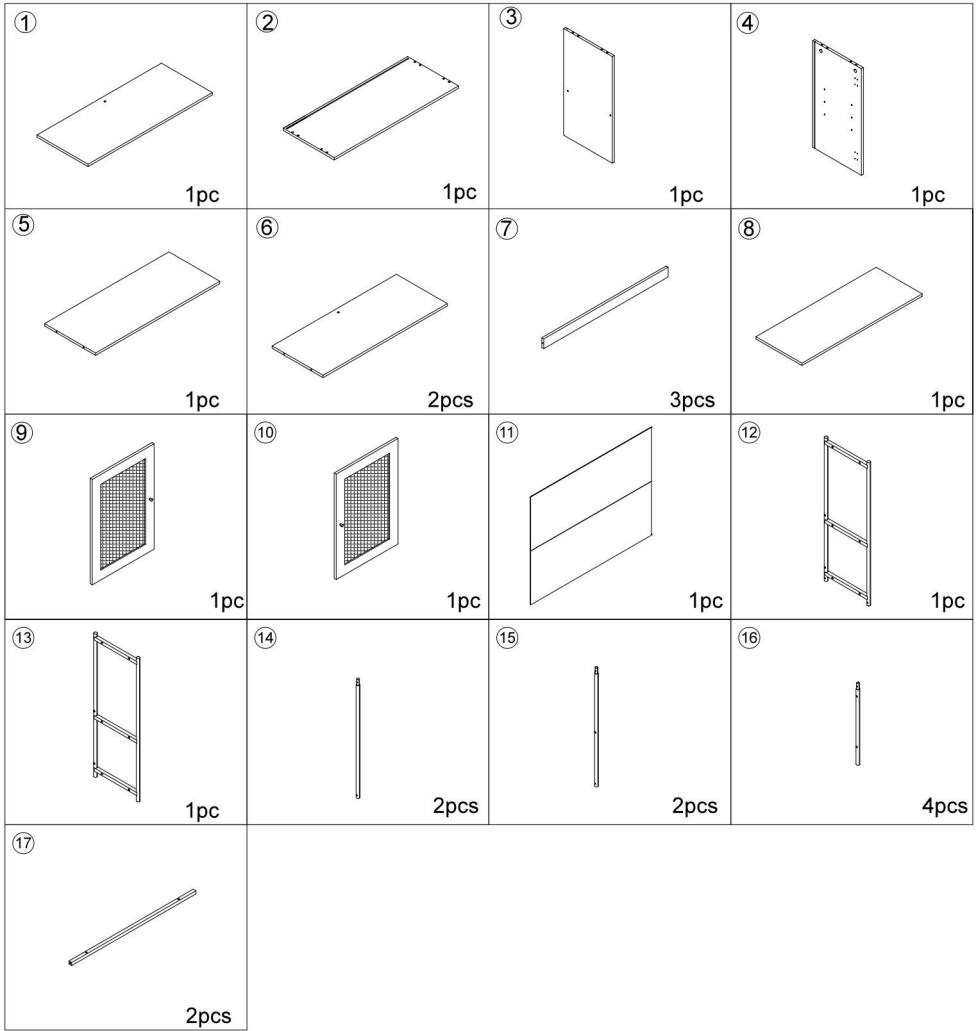









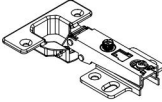

Modell	HY-BTJ-008
Technische Daten (L x B x H) (mm)	764*300*1747
Nettogewicht (kg)	Über 21

\*Produkte wie Spezifikationen, Aussehen und Design können ohne vorherige Ankündigung geändert werden.

## **PACKAGE CONTENTS**

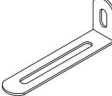







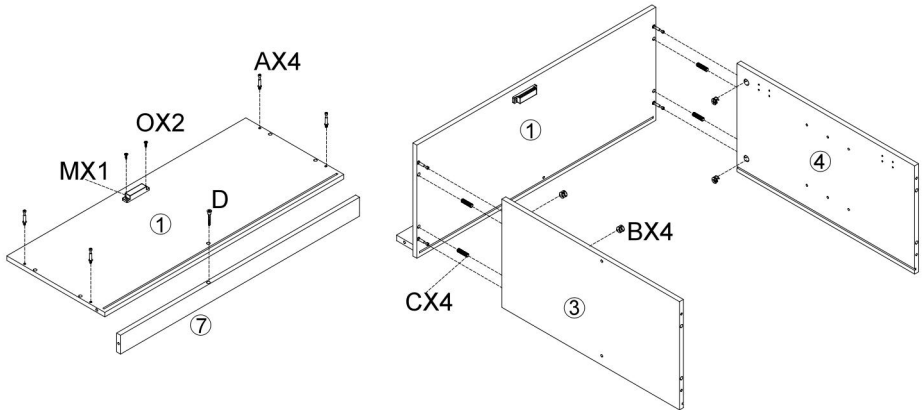

<p><b>A</b></p>  <p>4pcs</p>	<p><b>B</b></p>  <p>4pcs</p>	<p><b>C</b></p>  <p>8pcs</p>	<p><b>D</b></p>  <p>7pcs+1pc</p>
<p><b>E</b></p>  <p>6*25mm 8pcs+1pc</p>	<p><b>F</b></p>  <p>6*40mm 4pcs</p>	<p><b>G</b></p>  <p>6*10mm 8pcs+1pc</p>	<p><b>H</b></p>  <p>18pcs+1pc</p>
<p><b>I</b></p>  <p>4pcs</p>	<p><b>J</b></p>  <p>3.5*12mm 29pcs+2pcs</p>	<p><b>K</b></p>  <p>2pcs</p>	<p><b>L</b></p>  <p>2pcs</p>
<p><b>M</b></p>  <p>1pc</p>	<p><b>N</b></p>  <p>2pcs</p>	<p><b>O</b></p>  <p>3*14mm 2pcs</p>	<p><b>P</b></p>  <p>4pcs</p>
<p><b>Q</b></p>  <p>1pc</p>	<p><b>R</b></p>  <p>1pc</p>	<p><b>S</b></p>  <p>4*30mm 1pc</p>	<p><b>T</b></p>  <p>4pcs</p>

# ASSEMBLY STEPS

## STEP : 1



D	B	C	A	M	O
					
1pc	4pcs	4pcs	4pcs	1pc	3*14mm 2pcs

## STEP : 2

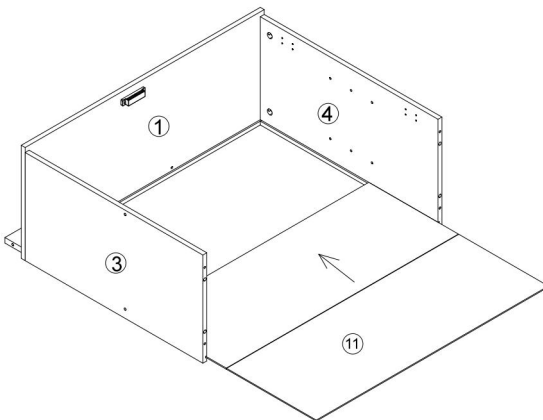

# STEP : 3

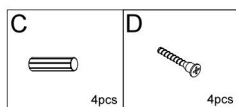
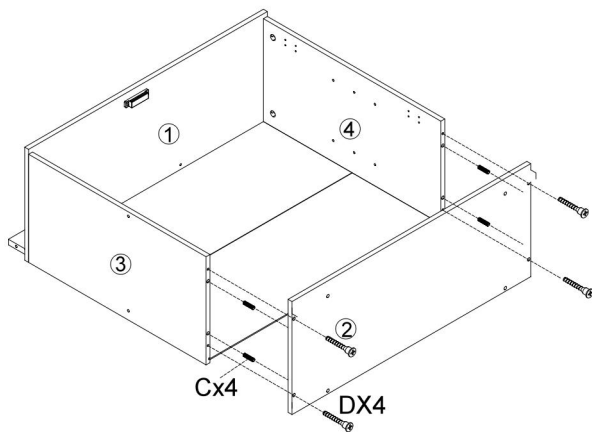

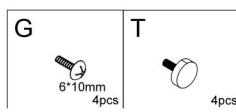
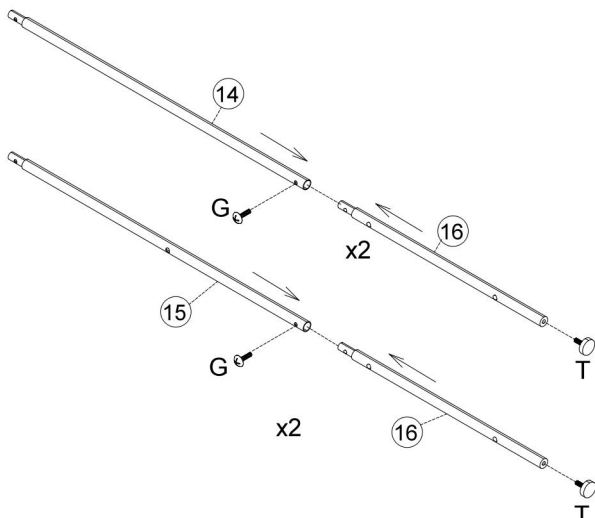

# STEP : 4



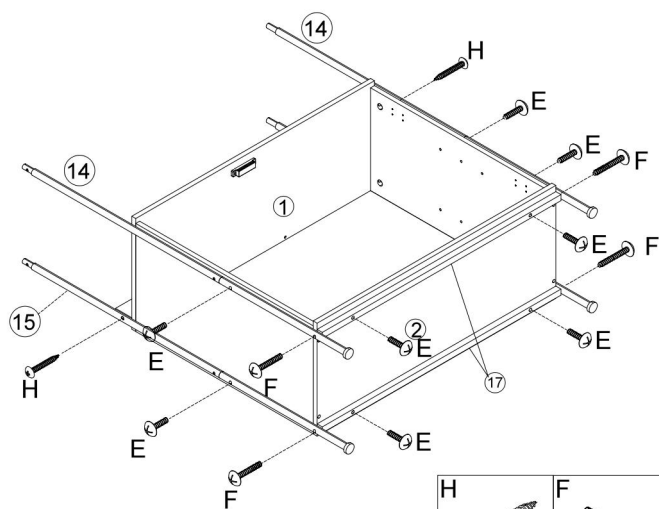



# STEP : 5

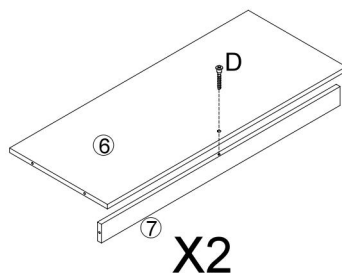
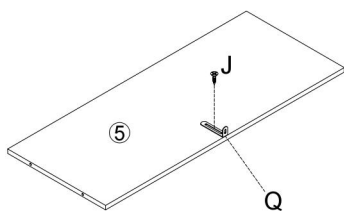

<p><b>H</b></p>  <p>2pcs</p>	<p><b>F</b></p>  <p>6*40mm 4pcs</p>	<p><b>E</b></p>  <p>6*25mm 8pcs</p>
---------------------------------------------------------------------------------------------------------------	--------------------------------------------------------------------------------------------------------------------------	---------------------------------------------------------------------------------------------------------------------------

# STEP : 6



<p><b>D</b></p>  <p>2pcs</p>	<p><b>J</b></p>  <p>3.5*12mm 1pc</p>	<p><b>Q</b></p>  <p>1pc</p>
-----------------------------------------------------------------------------------------------------------------	-----------------------------------------------------------------------------------------------------------------------------	-----------------------------------------------------------------------------------------------------------------

# STEP : 7

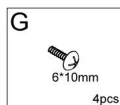
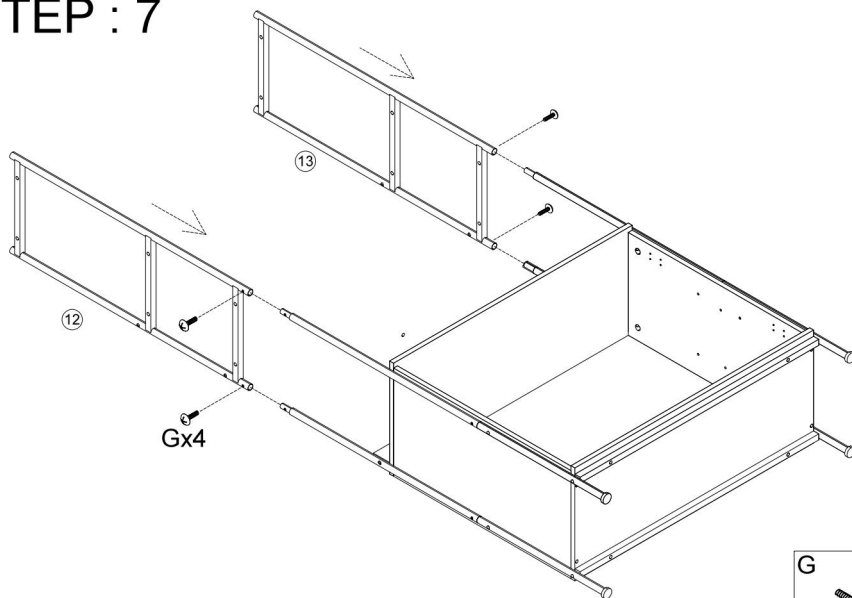

# STEP : 8

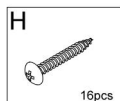
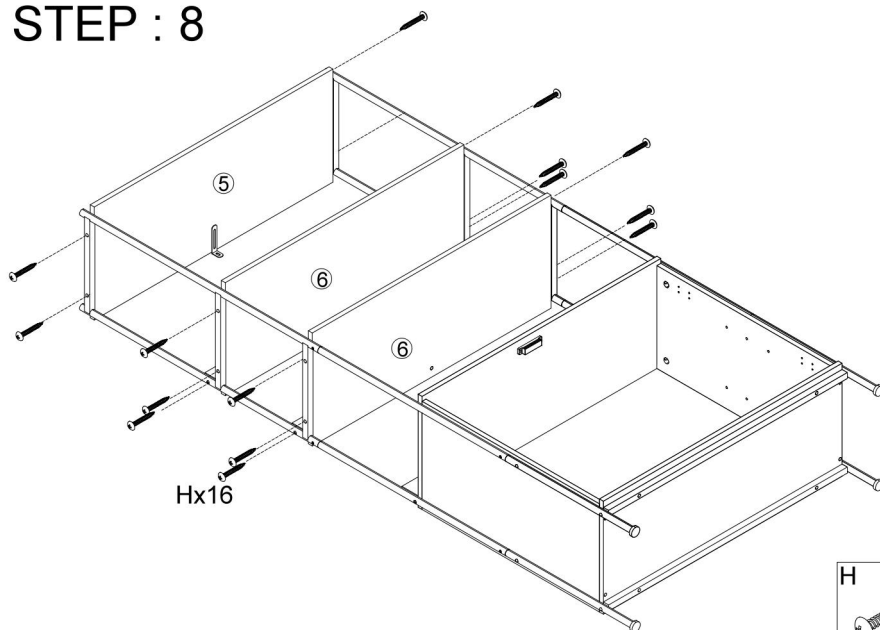

# STEP : 9

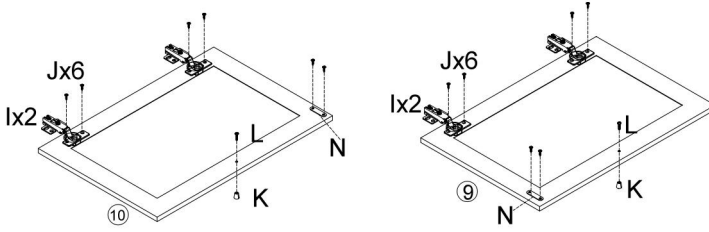

N	J	I	L	K
2pcs	3.5*12mm 12pcs	4pcs	2pcs	2pcs

# STEP : 10

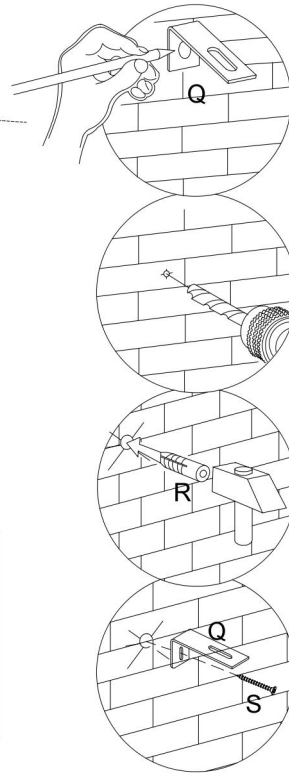
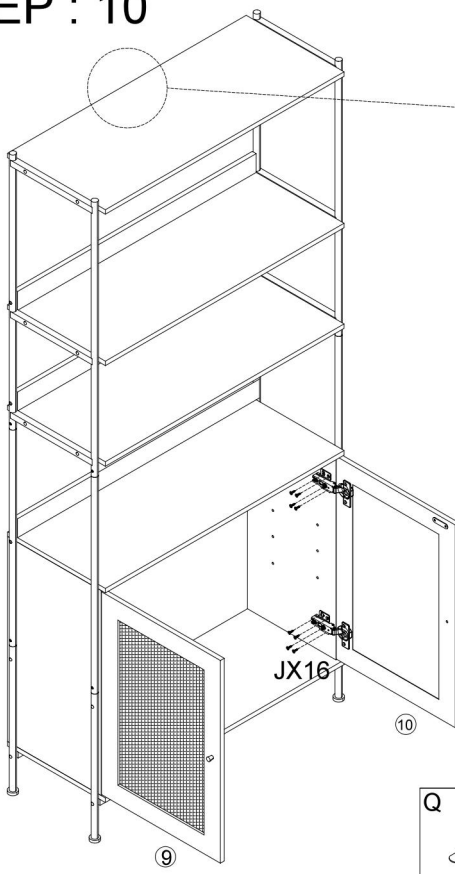

Q	S	R	J
1pc	4*30mm 16pcs	1pc	1pc

# STEP : 11

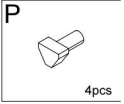
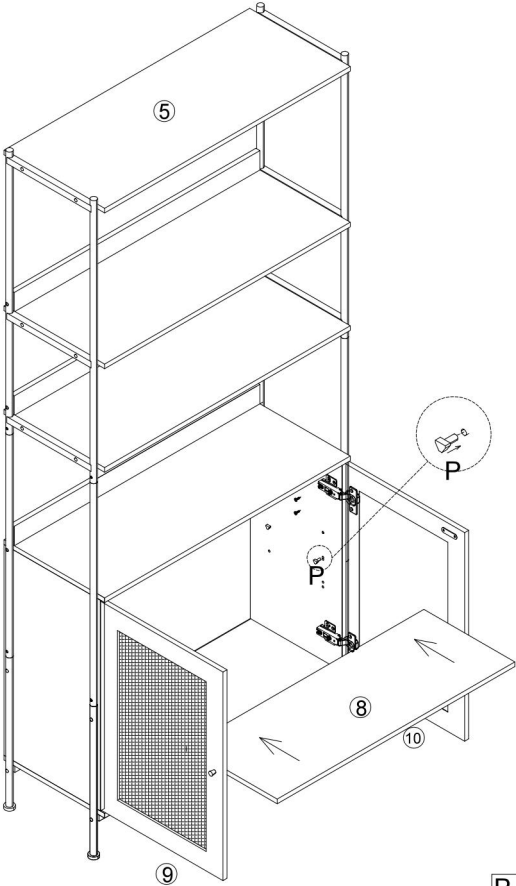

## COMPLETION

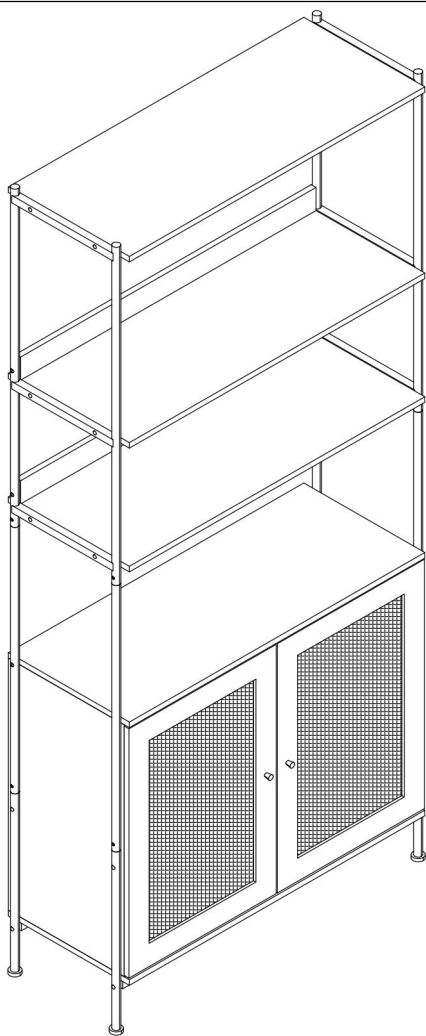

## WARNING



Children have died from furniture tipover. To reduce the risk of furniture tipover:

- ALWAYS install tipover restraint provided.
- NEVER put a TV on this product.
- NEVER allow children to stand, climb or hang on drawers, doors, or shelves.
- NEVER open more than one drawer at a time.
- Place heaviest items in the lowest drawers.

**Hersteller:** Shanghai muxinmuyeyouxiangongsi

**Adresse:** Shuangchenglu 803nong11hao1602A-1609shi, baoshanqu, Shanghai 200000 CN.

**Nach AUS importiert:** SIHAO PTY LTD. 1 ROKEVA  
STREETEASTWOOD NSW 2122 Australien

**Importiert in die USA:** Sanven Technology Ltd. Suite 250, 9166 Anaheim  
Place, Rancho Cucamonga, CA 91730

<b>EC</b>	<b>REP</b>
-----------	------------

E-CrossStu GmbH  
Mainzer Landstr.69, 60329 Frankfurt am Main.

<b>UK</b>	<b>REP</b>
-----------	------------

YH CONSULTING LIMITED.  
C/O YH Consulting Limited Office 147, Centurion  
House, London Road, Staines-upon-Thames, Surrey,  
TW18 4AX

# VEVOR®

**TOUGH TOOLS, HALF PRICE**

**Technisch Support und E-Garantie-Zertifikat**

[www.vevor.com/support](http://www.vevor.com/support)

# **VEVOR<sup>®</sup>**

**TOUGH TOOLS, HALF PRICE**

Tecnico Supporto e certificato di garanzia elettronica [www.vevor.com/support](http://www.vevor.com/support)

## **LIBRERIE IN RATTAN**

### **MANUALE D' USO**

**MODELLO NUMERO: HY-BTJ-008**

Continuiamo a impegnarci per fornirvi strumenti a prezzi competitivi.

"Risparmia la metà", "Metà prezzo" o altre espressioni simili utilizzate solo da noi rappresenta una stima dei risparmi che potresti ottenere acquistando determinati strumenti con noi rispetto ai principali marchi top e non significa necessariamente copertina tutte le categorie di strumenti da noi offerti. Ti ricordiamo cortesemente di verificare accuratamente

quando effettui un ordine con noi se sei effettivamente Risparmio  
Metà rispetto ai marchi più importanti.

# VEVOR®

TOUGH TOOLS, HALF PRICE

## Rattan Bookshelves

MODELLO NUMERO: CODICE ARTICOLO: HY-BTJ-008

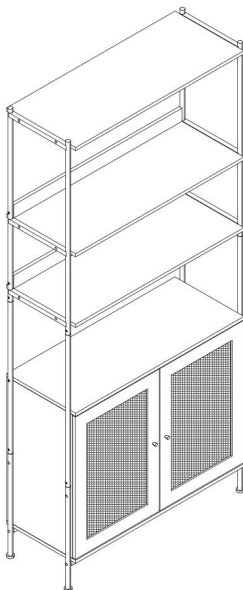

**HAI BISOGNO DI AIUTO? CONTATTACI!**

Hai domande sui prodotti? Hai bisogno di supporto tecnico? Non esitare a contattarci:

**Supporto tecnico e certificato di garanzia elettronica**  
**[www.vevor.com/support](http://www.vevor.com/support)**

Questa è l'istruzione originale, si prega di leggere attentamente tutte le istruzioni del manuale prima di utilizzare. VEVOR si riserva una chiara interpretazione del nostro manuale utente. L'aspetto del prodotto sarà soggetto al prodotto ricevuto. Vi preghiamo di perdonarci se non vi informeremo di nuovo se ci sono aggiornamenti tecnologici o software sul nostro prodotto.

## **AVVERTIMENTO:**

**Si prega di leggere attentamente questo manuale prima di utilizzare il prodotto. La mancata osservanza di questa precauzione potrebbe causare gravi lesioni.**



Please read and observe carefully all the assembly instructions before beginning assembly.

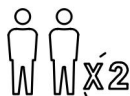

Unit should be assembled by two or more people.



**DO NOT CLIMB**

Please do not let your child climb on the product. If you have kids or animals who like to climb, we highly recommend using the wall anchors and brackets/straps that come with the package.

## **PRECAUZIONI DI MONTAGGIO**

25. Montare solo secondo queste istruzioni. Un montaggio improprio può creare pericoli.
26. Durante il montaggio, indossare occhiali di sicurezza omologati ANSI e guanti da lavoro resistenti.
27. Mantenere l'area di riunione pulita e ben illuminata.
28. Tenere gli astanti fuori dalla zona durante l'assemblea.
29. Non riunirsi quando si è stanchi o sotto l'effetto di alcol, droghe o farmaci.
30. Le capacità del prodotto si applicano solo ai prodotti correttamente e

completamente assemblati.

31. Montare su una superficie piana, livellata, dura e liscia, in grado di sostenere in modo sicuro le librerie in rattan.

32. Per ulteriori informazioni sulle parti elencate nelle pagine seguenti, fare riferimento allo schema di montaggio di questo manuale. Disimballare e separare tutte le parti in un'area di lavoro pulita.

SALVA QUESTE ISTRUZIONI

## PRECAUZIONI D'USO

**PER PREVENIRE LESIONI GRAVI E MORTALI DOVUTE AL RIBALTAMENTO:**

13. Questo prodotto non è un giocattolo. Non permettere ai bambini di giocare con questo articolo o nelle sue vicinanze.

14. Non superare la capacità di peso prima dello spostamento.

15. Utilizzare solo su una superficie piana, dura e liscia, in grado di sostenere in modo sicuro una libreria in rattan completamente carica.

16. Utilizzare solo come previsto.

Ispezionare prima di ogni utilizzo; non utilizzare se alcune parti risultano allentate o danneggiate.

## TECHNICAL SPECIFICATIONS

Modello	Codice articolo: HY-BTJ-008
Dimensioni del prodotto (Lunghezza x Larghezza x	Dimensioni: 764*300*1747







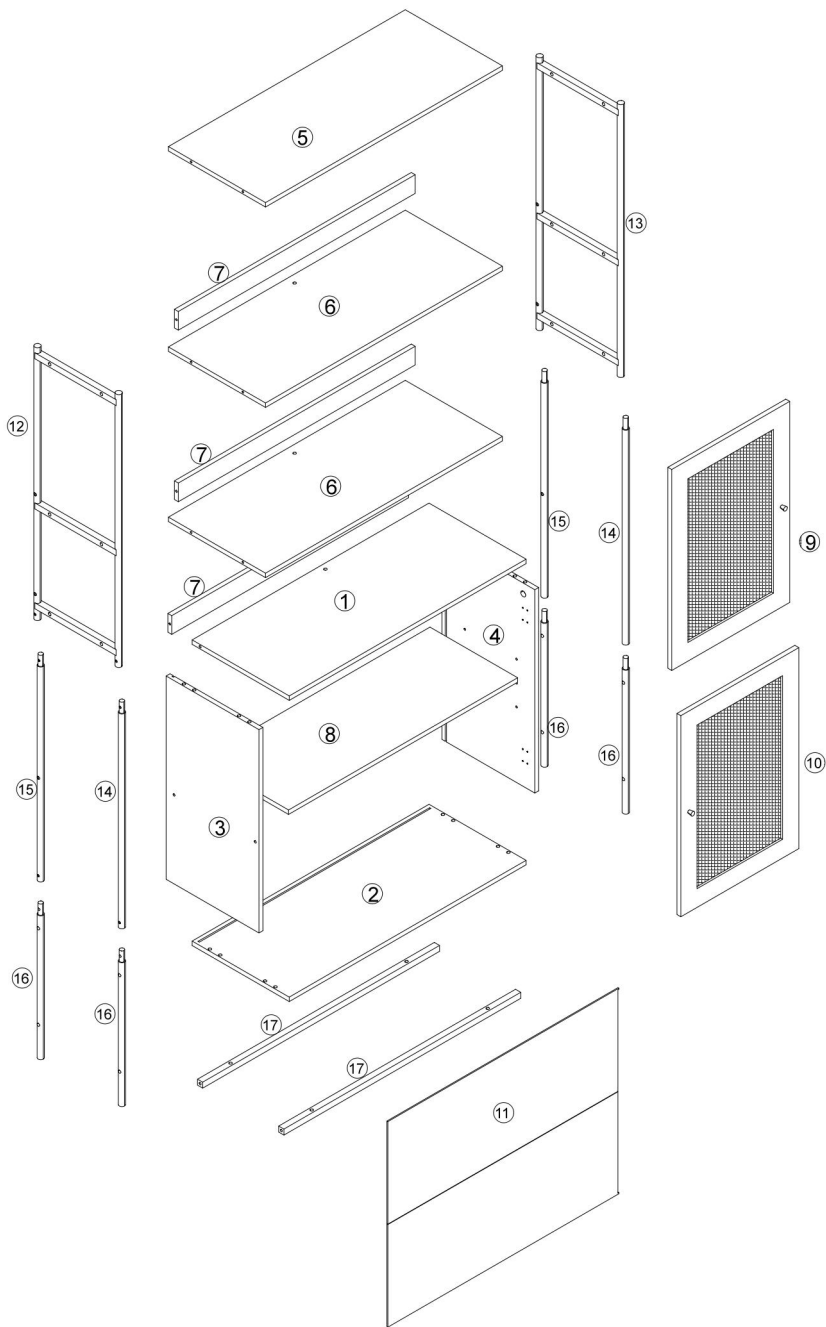

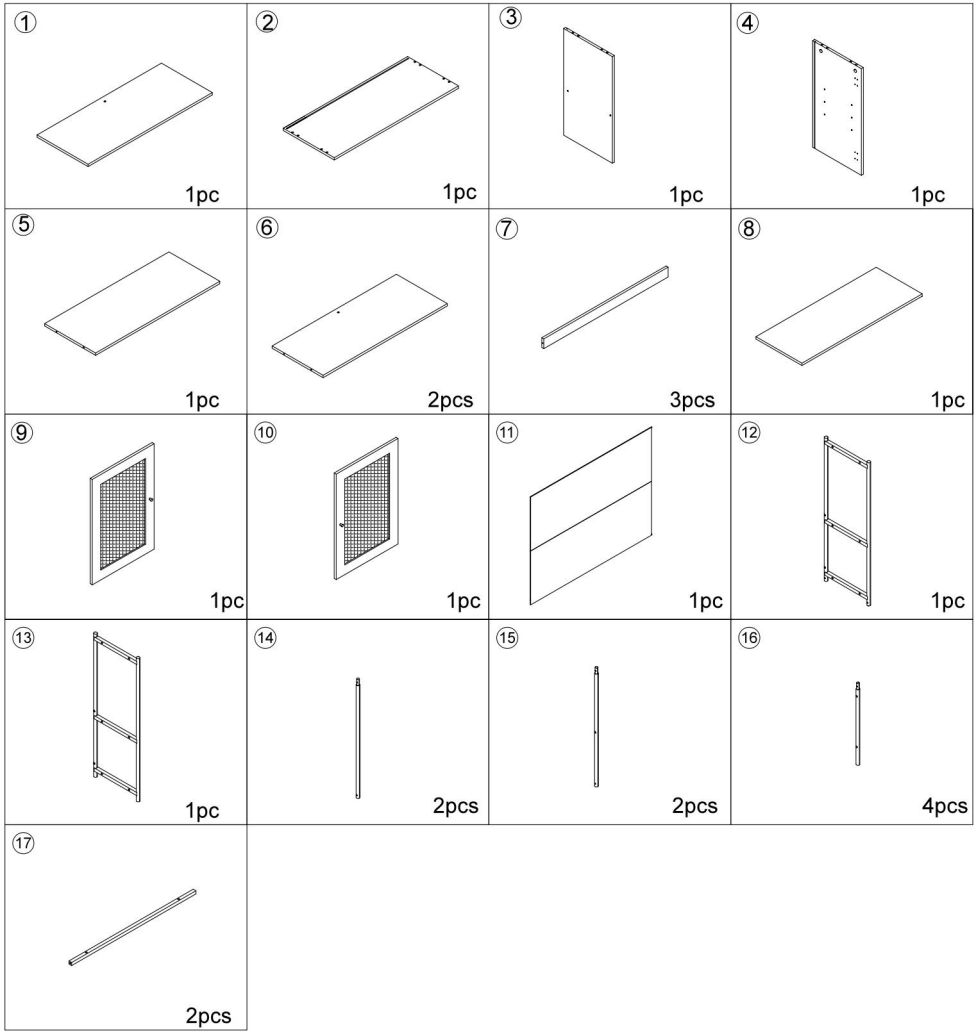









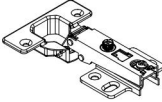

Altezza)(mm)	
Peso netto (kg)	Circa 21

\*Specifiche, aspetto e design dei prodotti sono soggetti a modifiche senza preavviso.

## **PACKAGE CONTENTS**

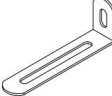







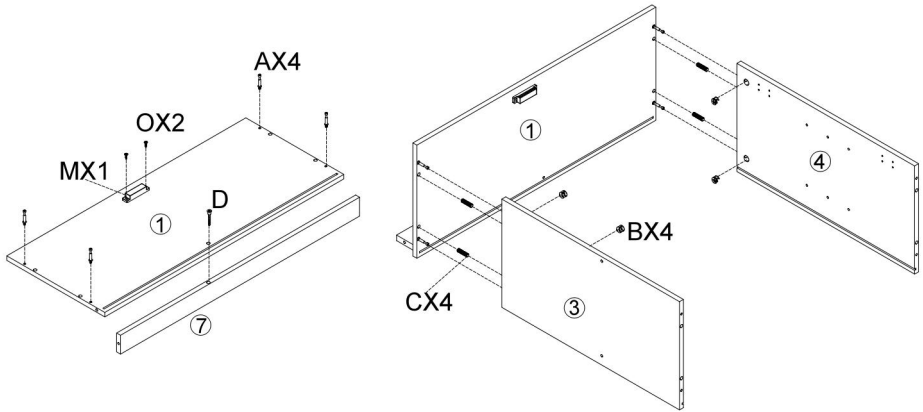

<p><b>A</b></p>  <p>4pcs</p>	<p><b>B</b></p>  <p>4pcs</p>	<p><b>C</b></p>  <p>8pcs</p>	<p><b>D</b></p>  <p>7pcs+1pc</p>
<p><b>E</b></p>  <p>6*25mm 8pcs+1pc</p>	<p><b>F</b></p>  <p>6*40mm 4pcs</p>	<p><b>G</b></p>  <p>6*10mm 8pcs+1pc</p>	<p><b>H</b></p>  <p>18pcs+1pc</p>
<p><b>I</b></p>  <p>4pcs</p>	<p><b>J</b></p>  <p>3.5*12mm 29pcs+2pcs</p>	<p><b>K</b></p>  <p>2pcs</p>	<p><b>L</b></p>  <p>2pcs</p>
<p><b>M</b></p>  <p>1pc</p>	<p><b>N</b></p>  <p>2pcs</p>	<p><b>O</b></p>  <p>3*14mm 2pcs</p>	<p><b>P</b></p>  <p>4pcs</p>
<p><b>Q</b></p>  <p>1pc</p>	<p><b>R</b></p>  <p>1pc</p>	<p><b>S</b></p>  <p>4*30mm 1pc</p>	<p><b>T</b></p>  <p>4pcs</p>

# ASSEMBLY STEPS

## STEP : 1



D	B	C	A	M	O
					
1pc	4pcs	4pcs	4pcs	1pc	3*14mm 2pcs

## STEP : 2

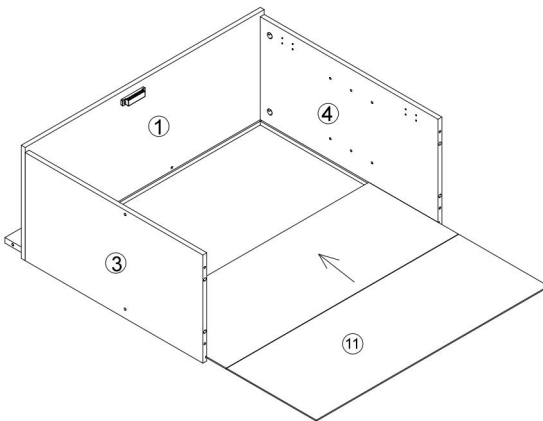

# STEP : 3

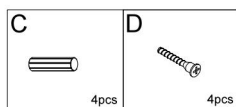
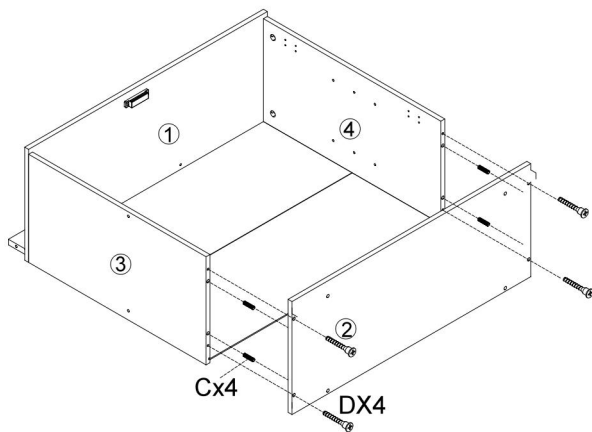

# STEP : 4

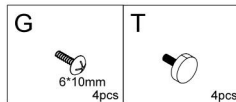
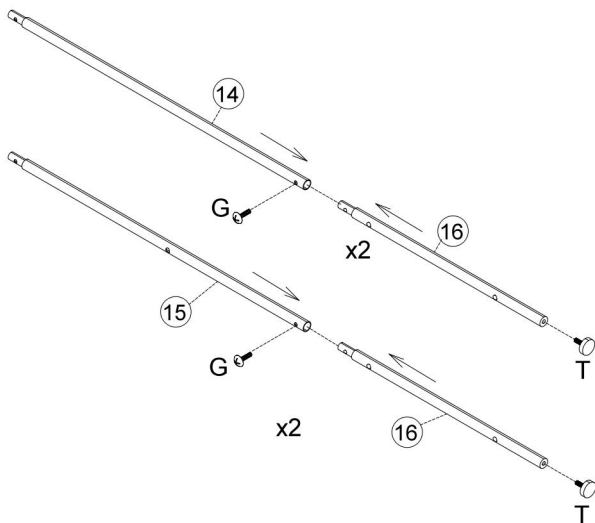

# STEP : 5

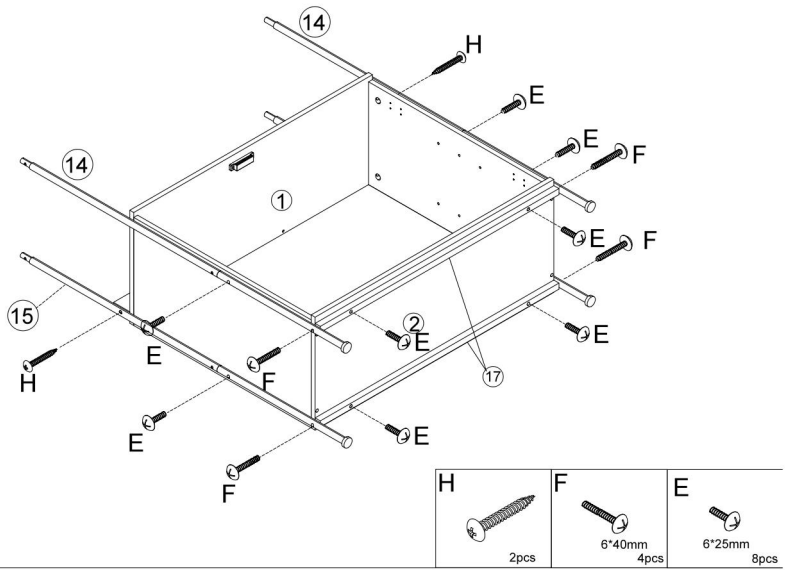

# STEP : 6

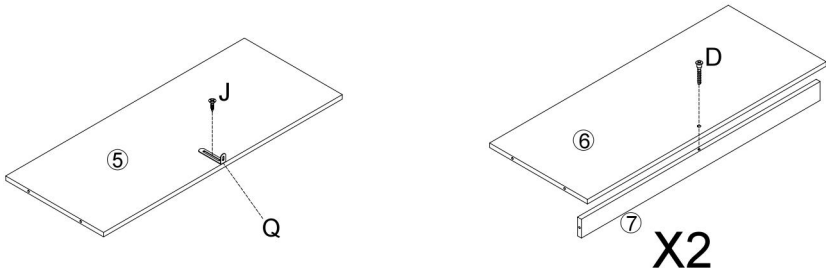

# STEP : 7

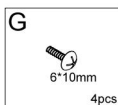
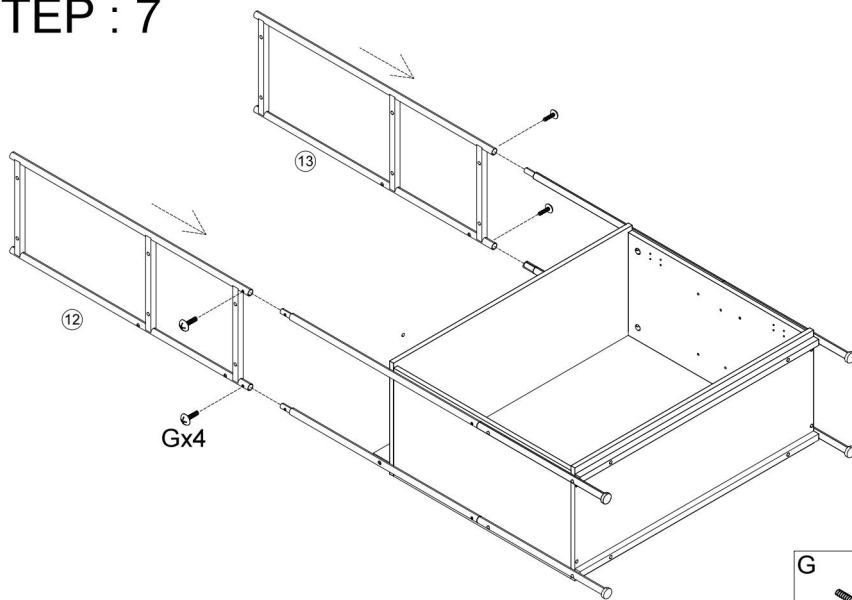

# STEP : 8

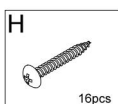
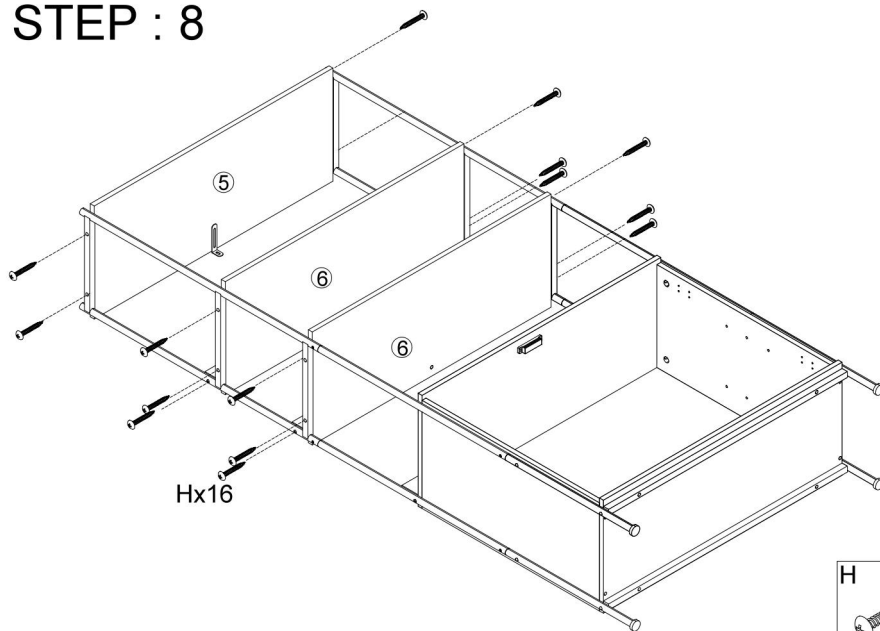

# STEP : 9

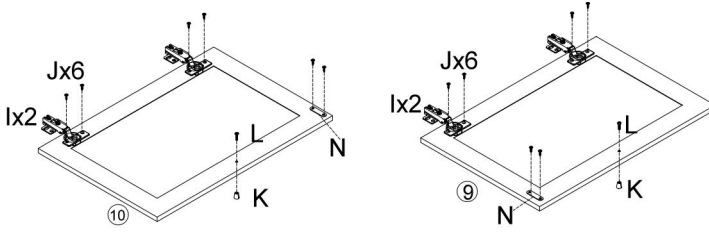

N	J	I	L	K
2pcs	3.5*12mm 12pcs	4pcs	2pcs	2pcs

# STEP : 10

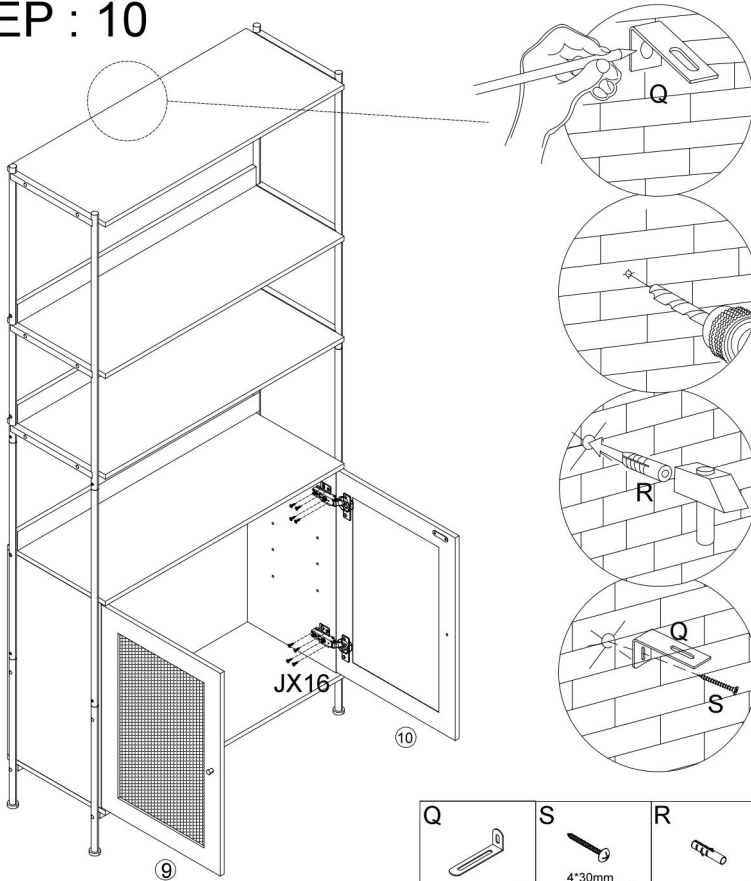

Q	S	R	J
1pc	4*30mm 16pcs	1pc	1pc

# STEP : 11

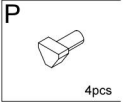
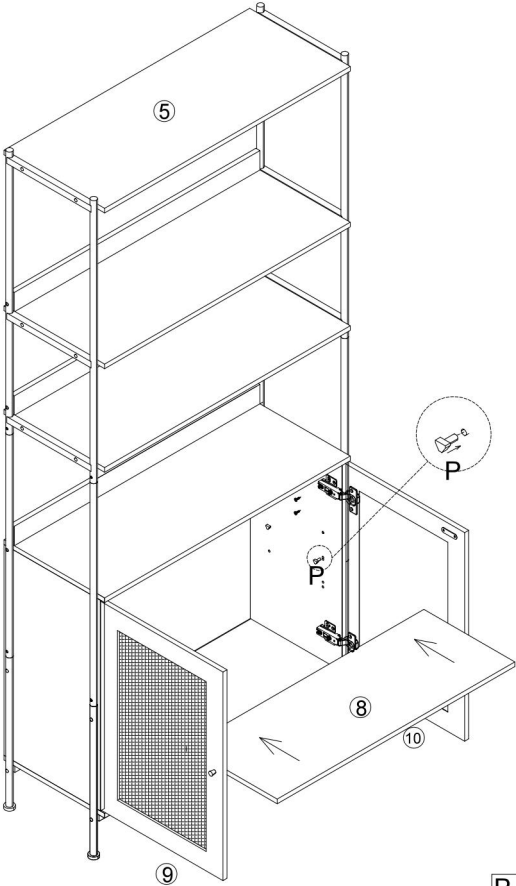

## COMPLETION

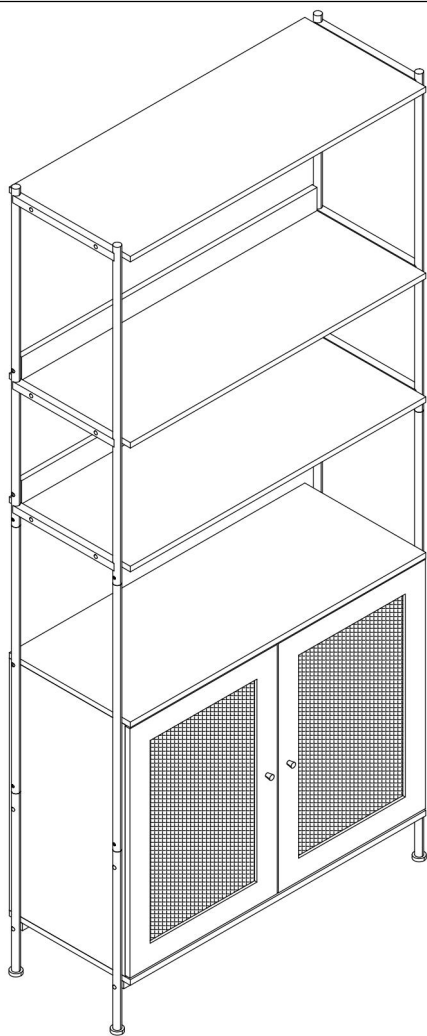

## WARNING



Children have died from furniture tipover. To reduce the risk of furniture tipover:

- ALWAYS install tipover restraint provided.
- NEVER put a TV on this product.
- NEVER allow children to stand, climb or hang on drawers, doors, or shelves.
- NEVER open more than one drawer at a time.
- Place heaviest items in the lowest drawers.

**Produttore:** Shanghaimuxinmuyeyouxiangongsi

**Indirizzo:** Shuangchenglu 803nong11hao1602A-1609shi, baoshanqu, shanghai 200000 CN.

**Importato in AUS:** SIHAO PTY LTD. 1 ROKEVA STREETEASTWOOD NSW 2122 Australia

**Importato negli USA:** Sanven Technology Ltd. Suite 250, 9166 Anaheim Place, Rancho Cucamonga, CA 91730

<b>EC</b>	<b>REP</b>
-----------	------------

E-CrossStu GmbH  
Mainzer Landstr.69, 60329 Frankfurt am Main.

<b>UK</b>	<b>REP</b>
-----------	------------

YH CONSULTING LIMITED.  
C/O YH Consulting Limited Office 147, Centurion House, London Road, Staines-upon-Thames, Surrey, TW18 4AX

# VEVOR®

**TOUGH TOOLS, HALF PRICE**

**Tecnico Supporto e certificato di garanzia elettronica**

[www.vevor.com/support](http://www.vevor.com/support)

# **VEVOR<sup>®</sup>**

**TOUGH TOOLS, HALF PRICE**

Técnico Soporte y certificado de garantía electrónica [www.vevor.com/support](http://www.vevor.com/support)

## **ESTANTERÍAS DE RATÁN**

### **MANUAL DEL USUARIO**

**NÚMERO DE MODELO: HY-BTJ-008**

Seguimos comprometidos a brindarle herramientas a precios competitivos. "Ahorra la mitad", "mitad de precio" o cualquier otra expresión similar utilizada únicamente por nosotros

Representa una estimación de los ahorros que podría obtener al comprar ciertas herramientas.

con nosotros en comparación con las principales marcas líderes y no significa necesariamente cubrir

Todas las categorías de herramientas que ofrecemos. Le recordamos que debe verificar con cuidado

Cuando realiza un pedido con nosotros, si realmente está Ahorro Medio en comparación con las principales marcas líderes.



# VEVOR®

TOUGH TOOLS, HALF PRICE

## Rattan Bookshelves

NÚMERO DE MODELO: HY-BTJ-008

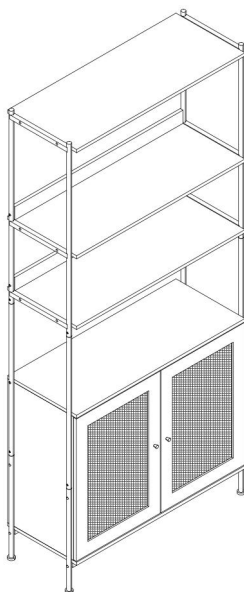

**¿NECESITAS AYUDA? ¡CONTÁCTANOS!**

¿Tiene preguntas sobre el producto? ¿Necesita asistencia técnica? No dude en ponerse en contacto con nosotros:

**Soporte técnico y certificado de garantía electrónica**

**[www.vevor.com/support](http://www.vevor.com/support)**

Estas son las instrucciones originales, lea atentamente todas las instrucciones del manual antes de utilizar el producto. VEVOR se reserva una interpretación clara de nuestro manual de usuario. La apariencia del producto estará sujeta al producto que recibió. Perdónenos por no informarle nuevamente si hay actualizaciones de tecnología o software en nuestro producto.

## **ADVERTENCIA:**

**Lea atentamente este manual antes de utilizar el producto. De lo contrario, podría sufrir lesiones graves.**



Please read and observe carefully all the assembly instructions before beginning assembly.

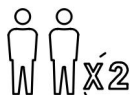

Unit should be assembled by two or more people.



DO NOT CLIMB

Please do not let your child climb on the product. If you have kids or animals who like to climb, we highly recommend using the wall anchors and brackets/straps that come with the package.

## **PRECAUCIONES DE MONTAJE**

33. Realice el montaje únicamente de acuerdo con estas instrucciones. Un montaje inadecuado puede generar peligros.
34. Use gafas de seguridad aprobadas por ANSI y guantes de trabajo resistentes durante el montaje.
35. Mantenga el área de reunión limpia y bien iluminada.
36. Mantenga a los transeúntes fuera del área durante el montaje.
37. No se reúna cuando esté cansado o bajo la influencia del alcohol, drogas o medicamentos.
38. Las capacidades del producto se aplican únicamente a productos ensamblados de forma correcta y completa.

39. Montar sobre una superficie plana, nivelada, dura y lisa capaz de soportar de forma segura las estanterías de ratán.

40. Para obtener información adicional sobre las piezas que se enumeran en las páginas siguientes, consulte el diagrama de ensamblaje de este manual. Desembale y separe todas las piezas en un área de trabajo limpia.

**GUARDE ESTAS INSTRUCCIONES**

## **PRECAUCIONES DE USO**

**PARA EVITAR LESIONES GRAVES Y LA MUERTE POR VUELCO:**

17. Este producto no es un juguete. No permita que los niños jueguen con este artículo o cerca de él.

18. No exceda las capacidades de peso antes de moverlo.

19. Úselo únicamente sobre una superficie plana, dura y lisa capaz de soportar de forma segura una estantería de ratán completamente cargada.

20. Úselo únicamente según lo previsto.

Inspeccione antes de cada uso; no utilice si las piezas están sueltas o dañadas.

### **TECHNICAL SPECIFICATIONS**

Modelo	HY-BTJ-008
Dimensiones del producto (Largo x Ancho x Alto) (mm)	764*300*1747







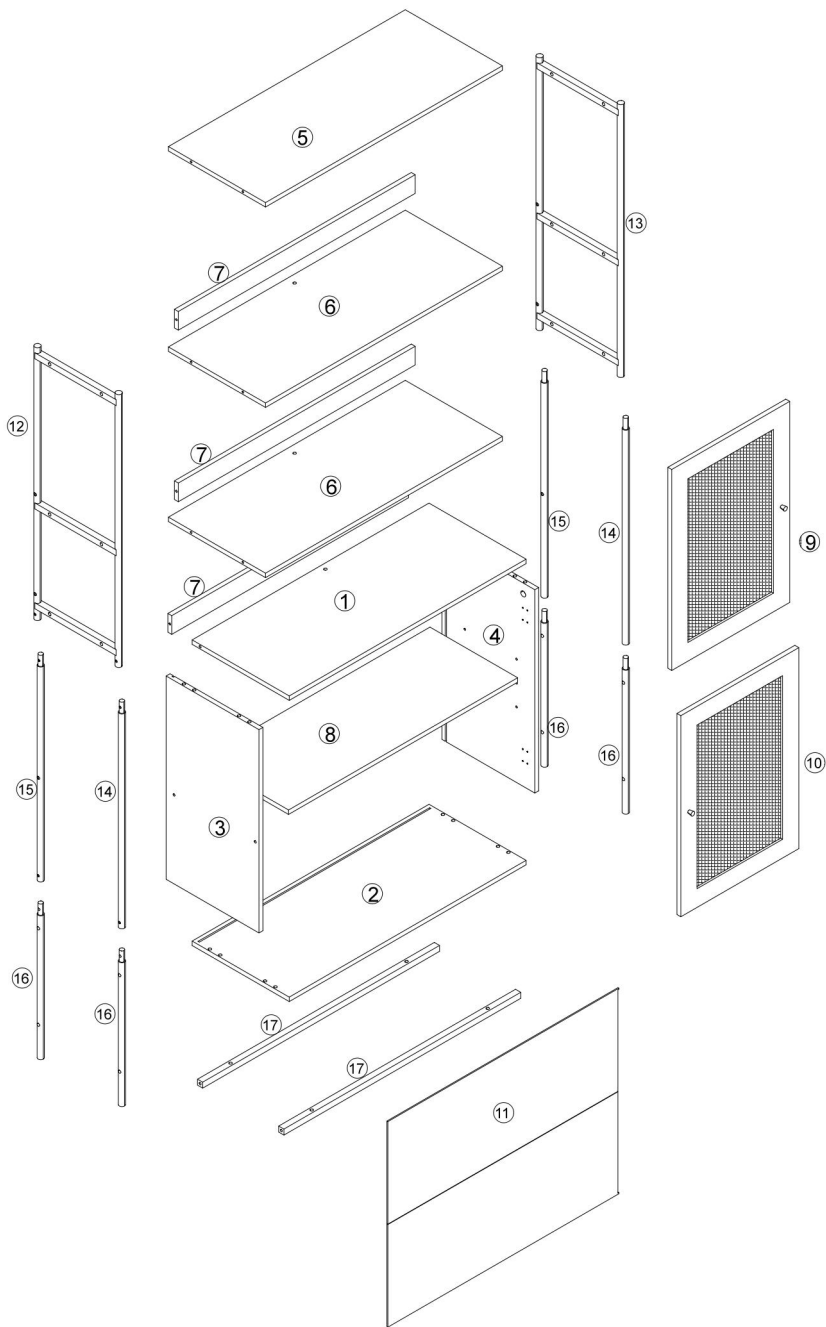

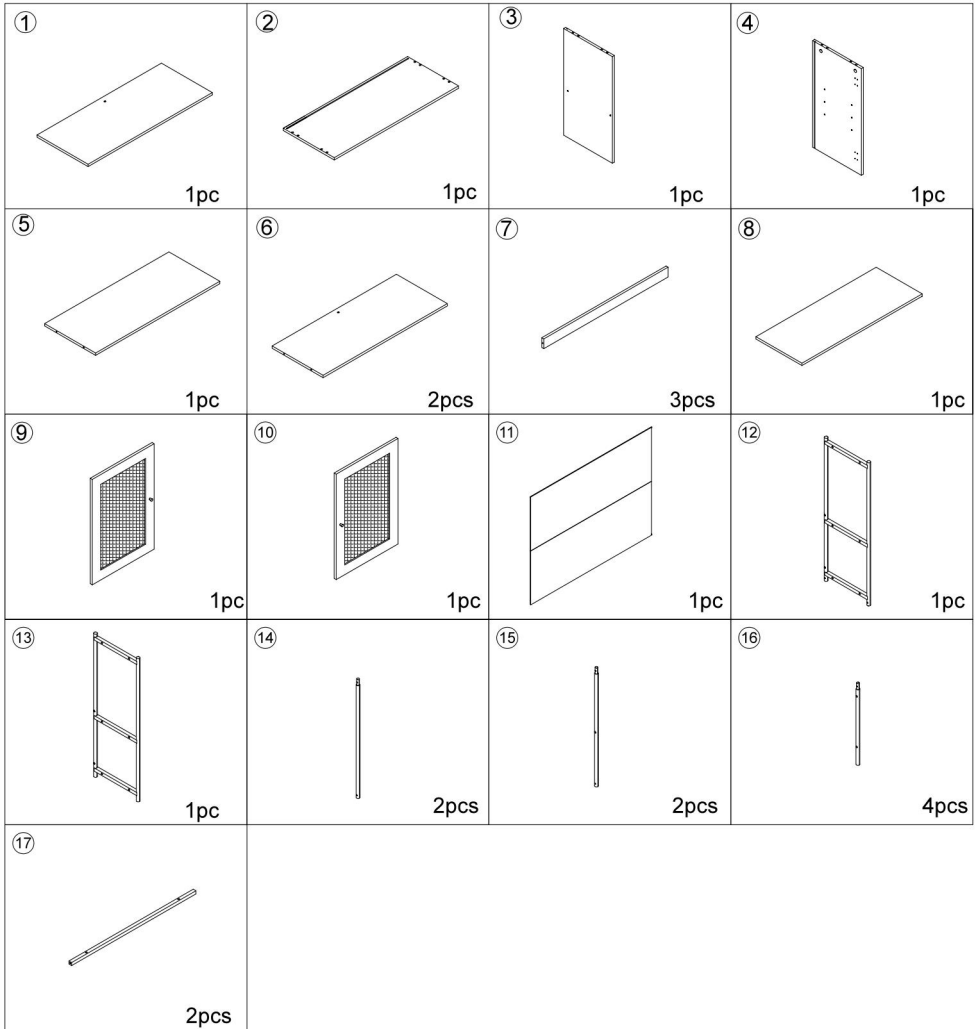









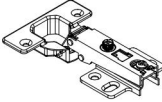

Peso neto (kg)	Acerca de 21
----------------	--------------

\*Los productos como especificaciones, apariencia y diseño están sujetos a modificaciones sin previo aviso.

## **PACKAGE CONTENTS**

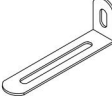







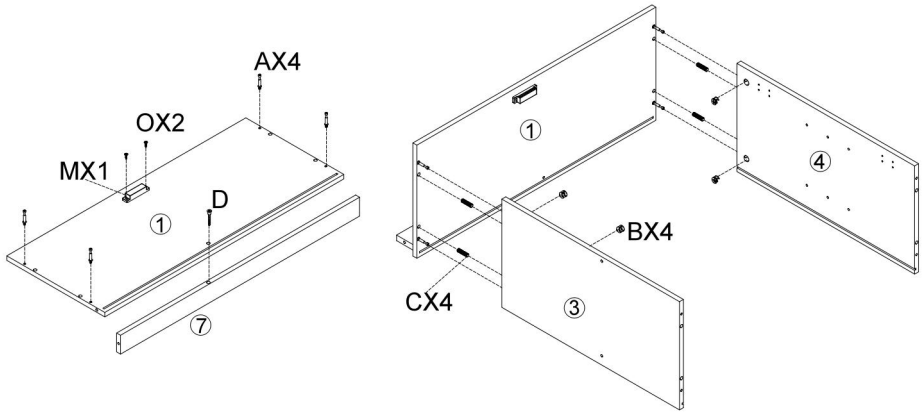

<p><b>A</b></p>  <p>4pcs</p>	<p><b>B</b></p>  <p>4pcs</p>	<p><b>C</b></p>  <p>8pcs</p>	<p><b>D</b></p>  <p>7pcs+1pc</p>
<p><b>E</b></p>  <p>6*25mm 8pcs+1pc</p>	<p><b>F</b></p>  <p>6*40mm 4pcs</p>	<p><b>G</b></p>  <p>6*10mm 8pcs+1pc</p>	<p><b>H</b></p>  <p>18pcs+1pc</p>
<p><b>I</b></p>  <p>4pcs</p>	<p><b>J</b></p>  <p>3.5*12mm 29pcs+2pcs</p>	<p><b>K</b></p>  <p>2pcs</p>	<p><b>L</b></p>  <p>2pcs</p>
<p><b>M</b></p>  <p>1pc</p>	<p><b>N</b></p>  <p>2pcs</p>	<p><b>O</b></p>  <p>3*14mm 2pcs</p>	<p><b>P</b></p>  <p>4pcs</p>
<p><b>Q</b></p>  <p>1pc</p>	<p><b>R</b></p>  <p>1pc</p>	<p><b>S</b></p>  <p>4*30mm 1pc</p>	<p><b>T</b></p>  <p>4pcs</p>

# ASSEMBLY STEPS

## STEP : 1



<b>D</b>  1pc	<b>B</b>  4pcs	<b>C</b>  4pcs	<b>A</b>  4pcs	<b>M</b>  1pc	<b>O</b>  3*14mm 2pcs
------------------------------------------------------------------------------------------------------	-------------------------------------------------------------------------------------------------------	-------------------------------------------------------------------------------------------------------	-------------------------------------------------------------------------------------------------------	------------------------------------------------------------------------------------------------------	------------------------------------------------------------------------------------------------------------------

## STEP : 2

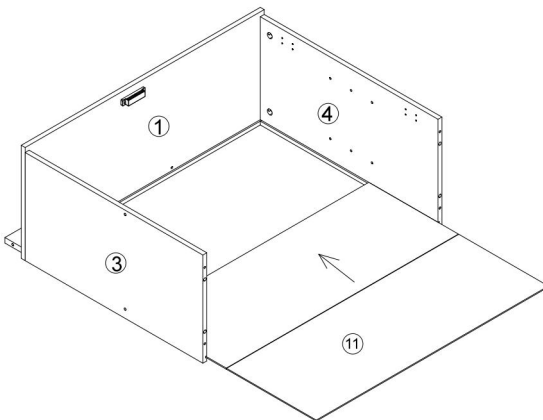

# STEP : 3

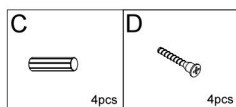
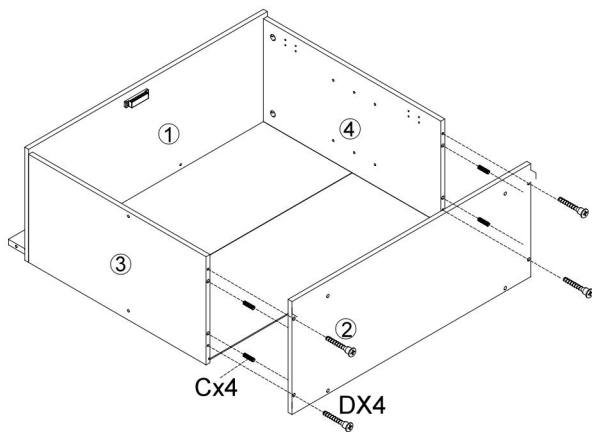

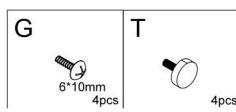
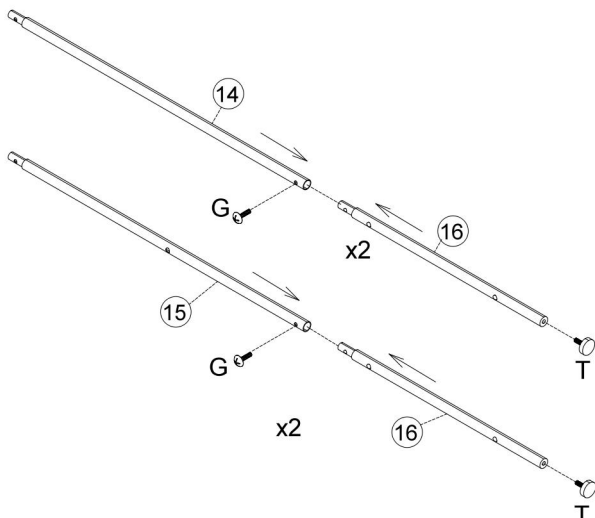

# STEP : 4



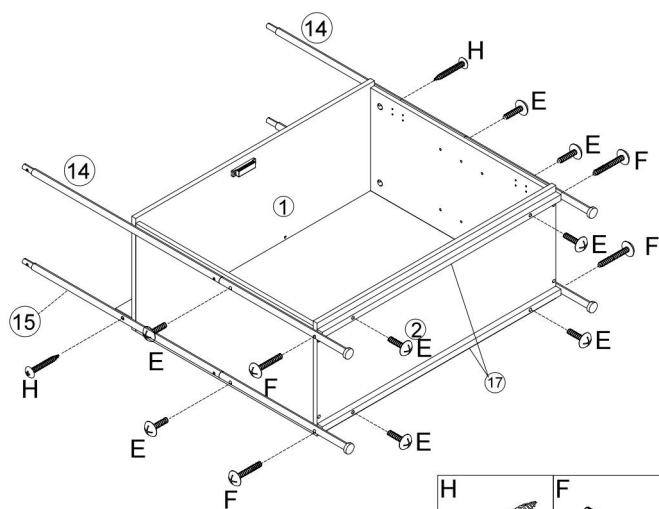



# STEP : 5

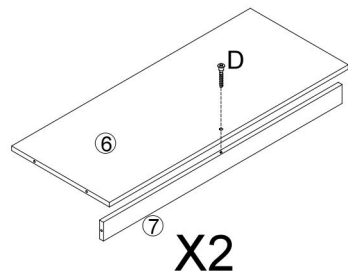
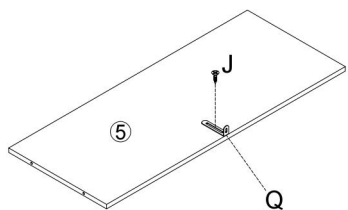

<p><b>H</b></p>  <p>2pcs</p>	<p><b>F</b></p>  <p>6*40mm 4pcs</p>	<p><b>E</b></p>  <p>6*25mm 8pcs</p>
---------------------------------------------------------------------------------------------------------------	--------------------------------------------------------------------------------------------------------------------------	---------------------------------------------------------------------------------------------------------------------------

# STEP : 6



<p><b>D</b></p>  <p>2pcs</p>	<p><b>J</b></p>  <p>3.5*12mm 1pc</p>	<p><b>Q</b></p>  <p>1pc</p>
-----------------------------------------------------------------------------------------------------------------	-----------------------------------------------------------------------------------------------------------------------------	-----------------------------------------------------------------------------------------------------------------

# STEP : 7

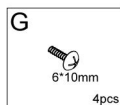
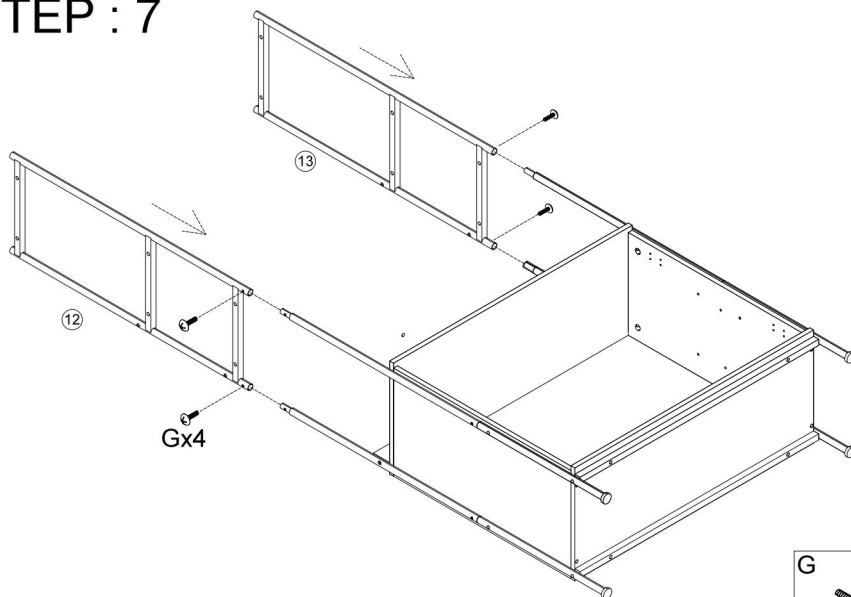

# STEP : 8

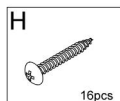
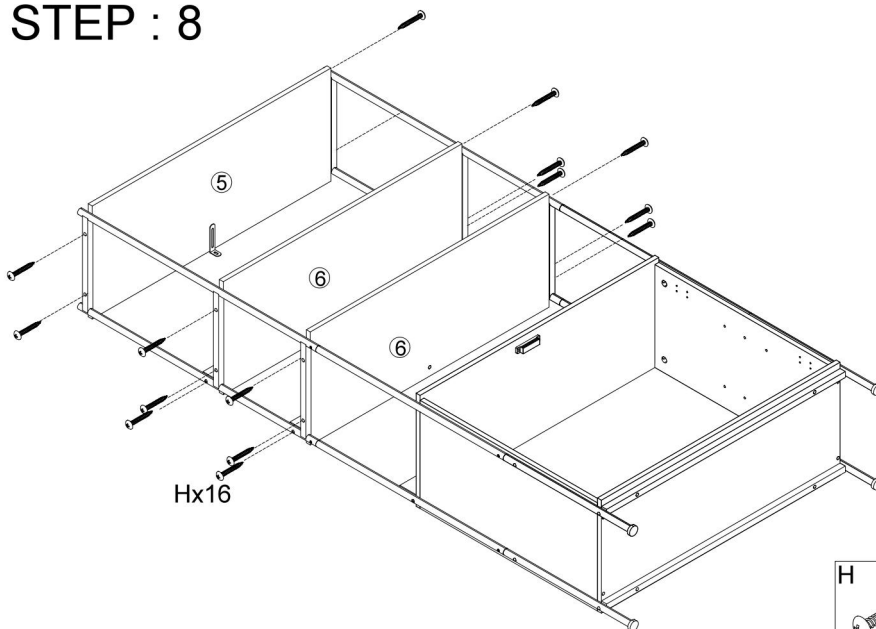

# STEP : 9

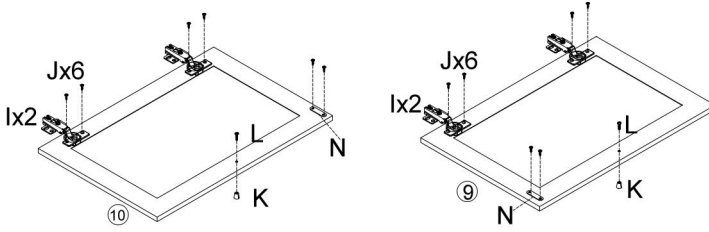

N	J	I	L	K
2pcs	3.5*12mm 12pcs	4pcs	2pcs	2pcs

# STEP : 10

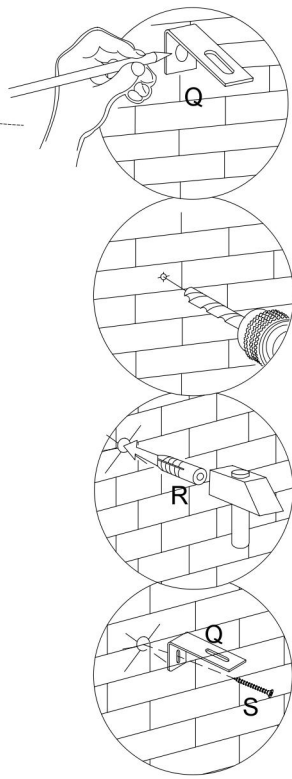
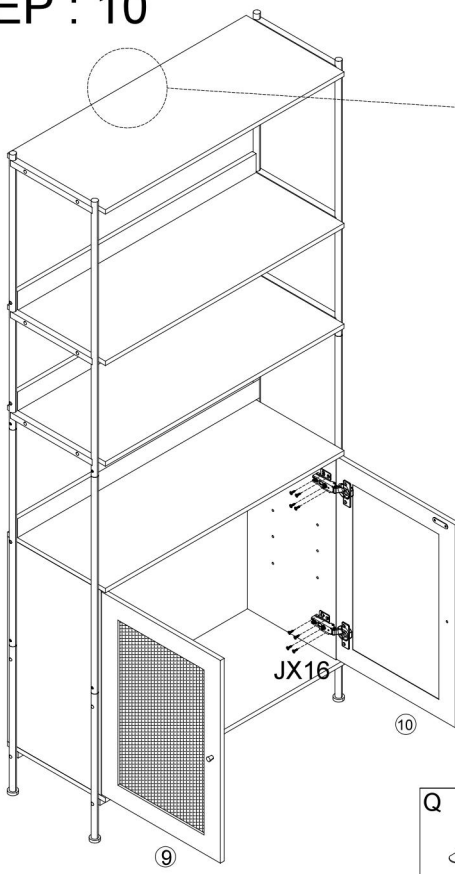

Q	S	R	J
1pc	4*30mm 16pcs	1pc	1pc



# STEP : 11

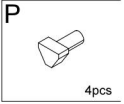
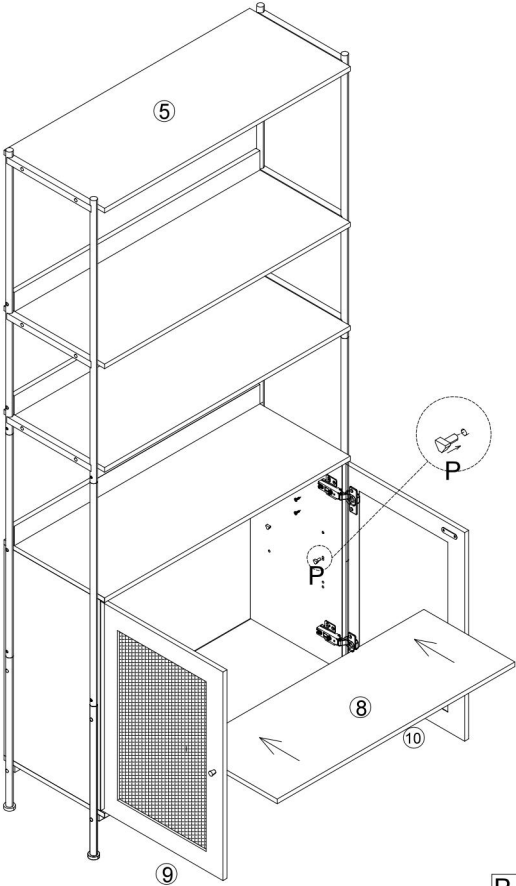

## COMPLETION

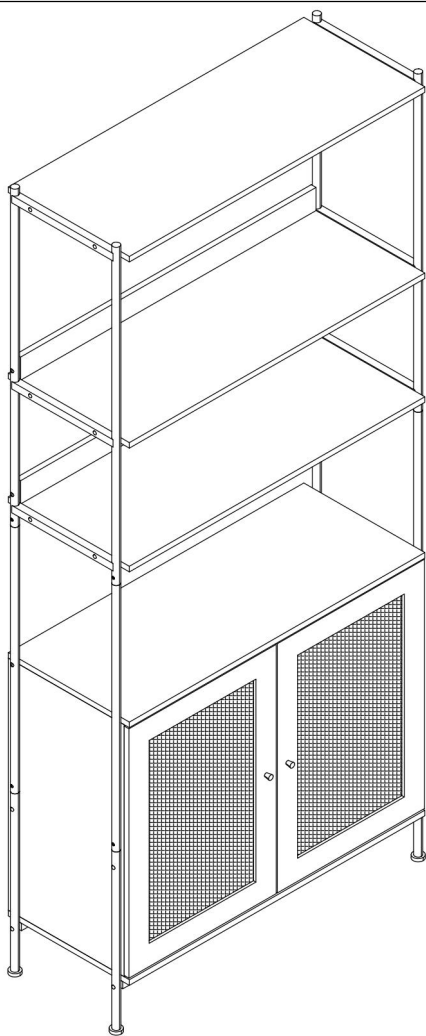

## WARNING



Children have died from furniture tipover. To reduce the risk of furniture tipover:

- ALWAYS install tipover restraint provided.
- NEVER put a TV on this product.
- NEVER allow children to stand, climb or hang on drawers, doors, or shelves.
- NEVER open more than one drawer at a time.
- Place heaviest items in the lowest drawers.

**Fabricante:** Shanghaimuxinmuyeyouxiangongsi

**Dirección:** Shuangchenglu 803nong11hao1602A-1609shi, baoshanqu, shanghai 200000 CN.

**Importado a AUS:** SIHAO PTY LTD. 1 ROKEVA STREETEASTWOOD NSW 2122 Australia

**Importado a EE. UU.:** Sanven Technology Ltd. Suite 250, 9166 Anaheim Place, Rancho Cucamonga, CA 91730

<b>EC</b>	<b>REP</b>
-----------	------------

E-CrossStu GmbH  
Mainzer Landstr.69, 60329 Frankfurt am Main.

<b>UK</b>	<b>REP</b>
-----------	------------

YH CONSULTING LIMITED.  
C/O YH Consulting Limited Office 147, Centurion House, London Road, Staines-upon-Thames, Surrey, TW18 4AX

# VEVOR®

**TOUGH TOOLS, HALF PRICE**

**Técnico Certificado de soporte y garantía electrónica**

[www.vevor.com/support](http://www.vevor.com/support)

# **VEVOR<sup>®</sup>**

**TOUGH TOOLS, HALF PRICE**

Techniczny Wsparcie i certyfikat gwarancji elektronicznej [www.vevor.com/support](http://www.vevor.com/support)

## **REGAŁY RATTANOWE**

### **INSTRUKCJA OBSŁUGI**

**NR MODELU: HY-BTJ-008**

Nadal staramy się oferować Państwu narzędzia w konkurencyjnych cenach. „Oszczędź połowę”, „Połowa ceny” lub jakiegokolwiek inne podobne wyrażenia używane wyłącznie przez nas przedstawia szacunkowe oszczędności, jakie możesz uzyskać kupując określone narzędzia z nami w porównaniu do głównych, najlepszych marek i niekoniecznie oznacza to okładka wszystkie kategorie narzędzi oferowanych przez nas. Przypominamy o sprawdzeniu ostrożnie gdy składasz u nas zamówienie, jeśli faktycznie Oszczędność Połowa w porównaniu z wiodącymi markami.

# VEVOR®

TOUGH TOOLS, HALF PRICE

## Rattan Bookshelves

NR MODELU: HY-BTJ-008

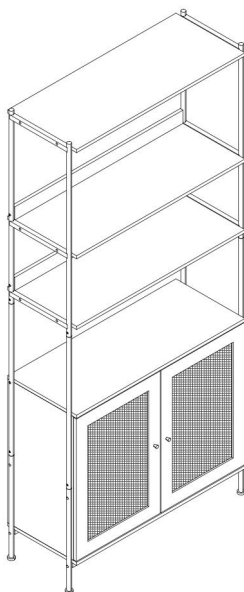

**POTRZEBUJESZ POMOCY? SKONTAKTUJ SIĘ Z NAMI!**

Masz pytania dotyczące produktu? Potrzebujesz wsparcia technicznego? Skontaktuj się z nami:

**Wsparcie techniczne i certyfikat e-gwarancji**  
**[www.vevor.com/support](http://www.vevor.com/support)**

To jest oryginalna instrukcja, przed użyciem należy uważnie przeczytać wszystkie instrukcje. VEVOR zastrzega sobie jasną interpretację naszej instrukcji obsługi. Wygląd produktu będzie zależał od produktu, który otrzymałeś. Prosimy o wybaczenie, że nie poinformujemy Cię ponownie, jeśli w naszym produkcie pojawią się jakiegokolwiek aktualizacje technologiczne lub oprogramowania.

## OSTRZEŻENIE:

**Przed użyciem produktu należy uważnie przeczytać tę instrukcję. Nieprzestrzeganie jej może skutkować poważnymi obrażeniami.**



Please read and observe carefully all the assembly instructions before beginning assembly.



Unit should be assembled by two or more people.



DO NOT CLIMB

Please do not let your child climb on the product. If you have kids or animals who like to climb, we highly recommend using the wall anchors and brackets/straps that come with the package.

# ŚRODKI OSTROŻNOŚCI PODCZAS MONTAŻU

41. Montaż należy wykonywać wyłącznie zgodnie z niniejszą instrukcją. Nieprawidłowy montaż może stwarzać zagrożenia.
42. Podczas montażu należy nosić okulary ochronne z atestem ANSI oraz wytrzymałe rękawice robocze.
43. Utrzymuj miejsce zgromadzenia w czystości i zapewnij dobre oświetlenie.
44. Nie dopuszczaj osób postronnych na teren montażu podczas jego trwania.
45. Nie przychodź na spotkania, jeśli jesteś zmęczony lub pod wpływem

alkoholu, narkotyków lub leków.

46. Możliwości produktu odnoszą się wyłącznie do produktów prawidłowo i kompletnie zamontowanych.

47. Montaż należy wykonać na płaskiej, równej, twardej i gładkiej powierzchni, która będzie w stanie bezpiecznie utrzymać regały rattanowe.

48. Aby uzyskać dodatkowe informacje dotyczące części wymienionych na kolejnych stronach, zapoznaj się ze schematem montażu w tym podręczniku. Rozpakuj i oddziel wszystkie części w czystym miejscu pracy.

ZAPISZ TE INSTRUKCJE

## **ŚRODKI OSTROŻNOŚCI**

**ABY ZAPOBIEC POWAŻNYM OBRAŻENIOM I ŚMIERCI SPOWODOWANEJ PRZEWRÓCENIEM:**

21. Ten produkt nie jest zabawką. Nie pozwalaj dzieciom bawić się tym przedmiotem ani przebywać w jego pobliżu.

22. Przed przeprowadzką nie przekraczaj dopuszczalnego ciężaru.

23. Stosować wyłącznie na płaskiej, twardej i gładkiej powierzchni, która może bezpiecznie utrzymać w pełni załadowane regały rattanowe.

24. Stosować wyłącznie zgodnie z przeznaczeniem.  
Przed każdym użyciem należy przeprowadzić kontrolę. Nie należy używać produktu, jeśli jakieś części są luźne lub uszkodzone.

### **TECHNICAL SPECIFICATIONS**

Model	HY-BTJ-008
-------	------------







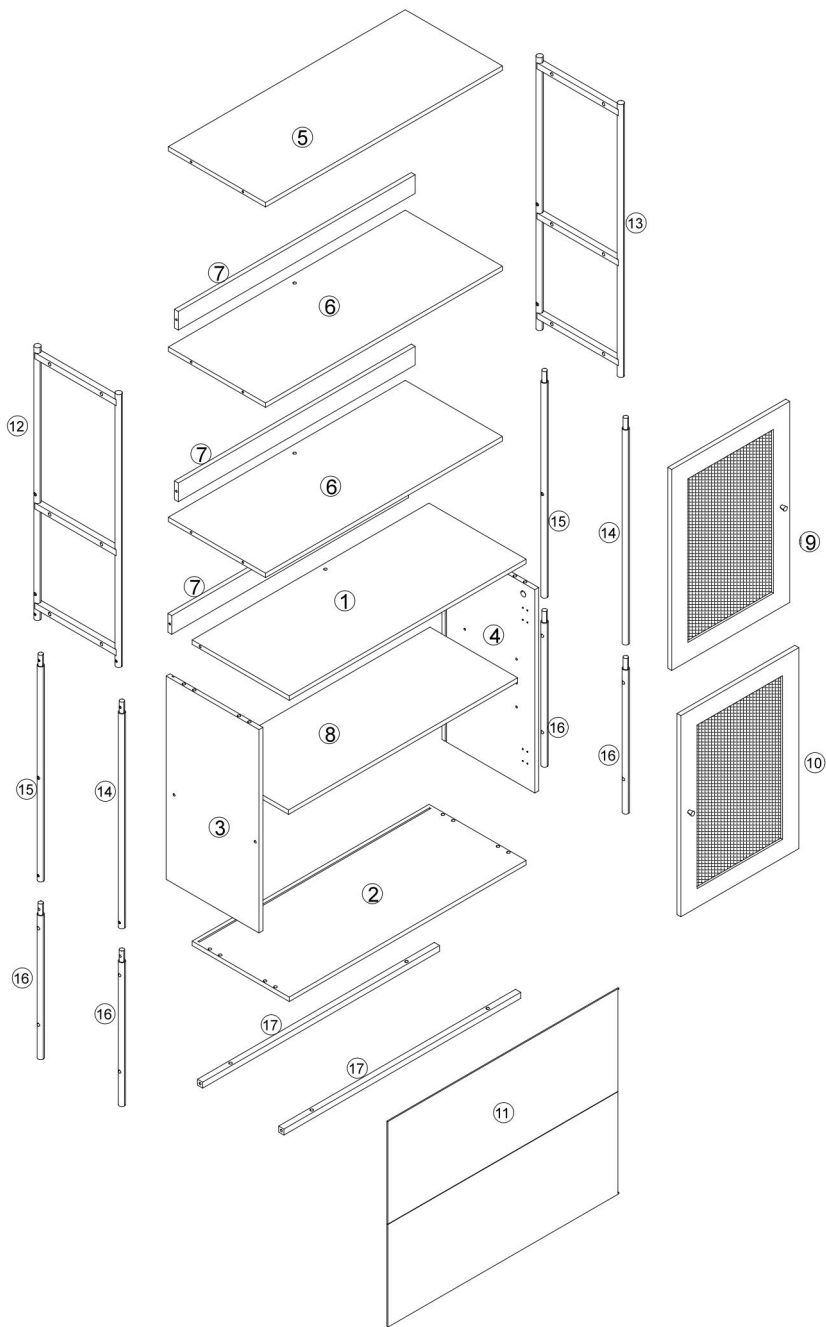

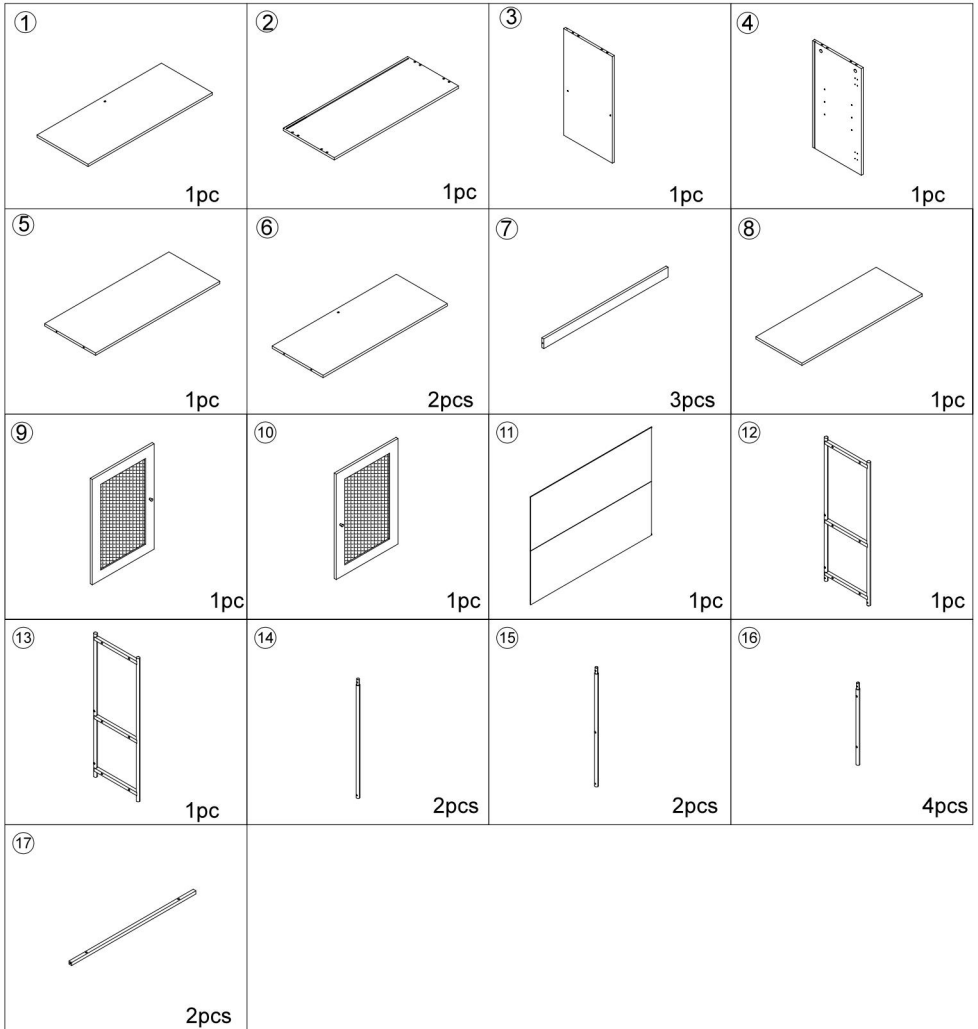









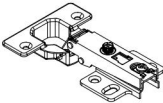

Wymiary produktu (Dł. x Szer. x Wys.) (mm)	764*300*1747
Masa netto (kg)	Okolo 21

\*Specyfikacja, wygląd i konstrukcja produktu mogą ulec zmianie bez wcześniejszego powiadomienia.

## **PACKAGE CONTENTS**

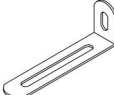







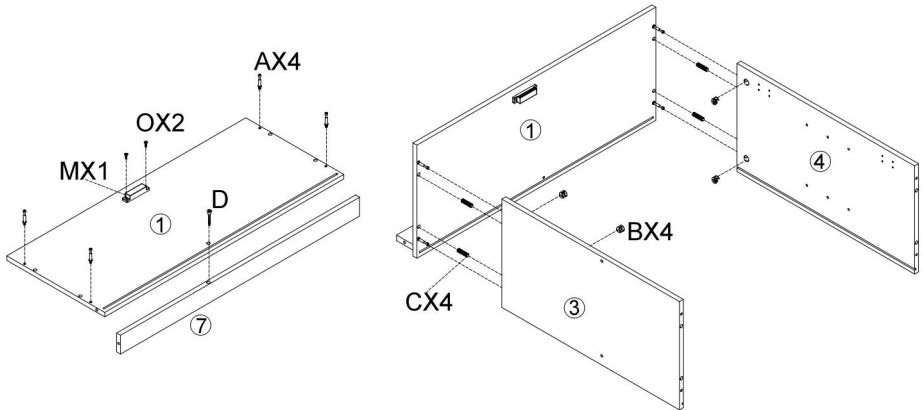

<p><b>A</b></p>  <p>4pcs</p>	<p><b>B</b></p>  <p>4pcs</p>	<p><b>C</b></p>  <p>8pcs</p>	<p><b>D</b></p>  <p>7pcs+1pc</p>
<p><b>E</b></p>  <p>6*25mm 8pcs+1pc</p>	<p><b>F</b></p>  <p>6*40mm 4pcs</p>	<p><b>G</b></p>  <p>6*10mm 8pcs+1pc</p>	<p><b>H</b></p>  <p>18pcs+1pc</p>
<p><b>I</b></p>  <p>4pcs</p>	<p><b>J</b></p>  <p>3.5*12mm 29pcs+2pcs</p>	<p><b>K</b></p>  <p>2pcs</p>	<p><b>L</b></p>  <p>2pcs</p>
<p><b>M</b></p>  <p>1pc</p>	<p><b>N</b></p>  <p>2pcs</p>	<p><b>O</b></p>  <p>3*14mm 2pcs</p>	<p><b>P</b></p>  <p>4pcs</p>
<p><b>Q</b></p>  <p>1pc</p>	<p><b>R</b></p>  <p>1pc</p>	<p><b>S</b></p>  <p>4*30mm 1pc</p>	<p><b>T</b></p>  <p>4pcs</p>

# ASSEMBLY STEPS

## STEP : 1



<p><b>D</b></p>  <p>1pc</p>	<p><b>B</b></p>  <p>4pcs</p>	<p><b>C</b></p>  <p>4pcs</p>	<p><b>A</b></p>  <p>4pcs</p>	<p><b>M</b></p>  <p>1pc</p>	<p><b>O</b></p>  <p>3*14mm 2pcs</p>
--------------------------------------------------------------------------------------------------------------	---------------------------------------------------------------------------------------------------------------	---------------------------------------------------------------------------------------------------------------	---------------------------------------------------------------------------------------------------------------	--------------------------------------------------------------------------------------------------------------	---------------------------------------------------------------------------------------------------------------------------

## STEP : 2

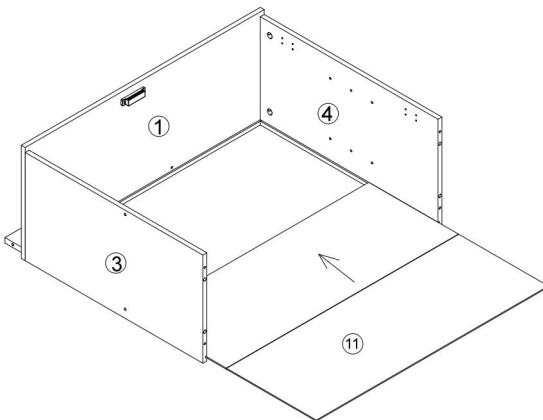

# STEP : 3

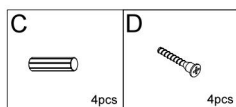
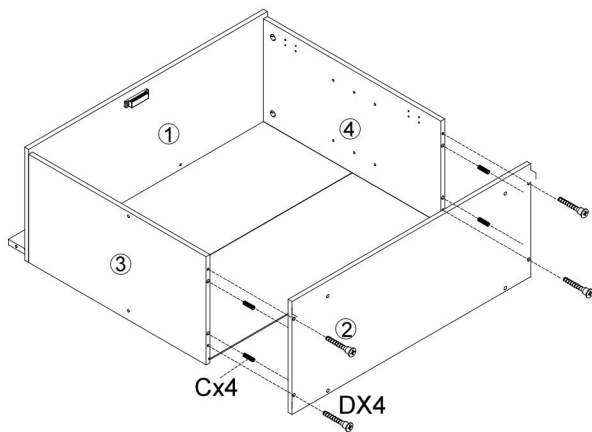

# STEP : 4

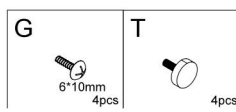
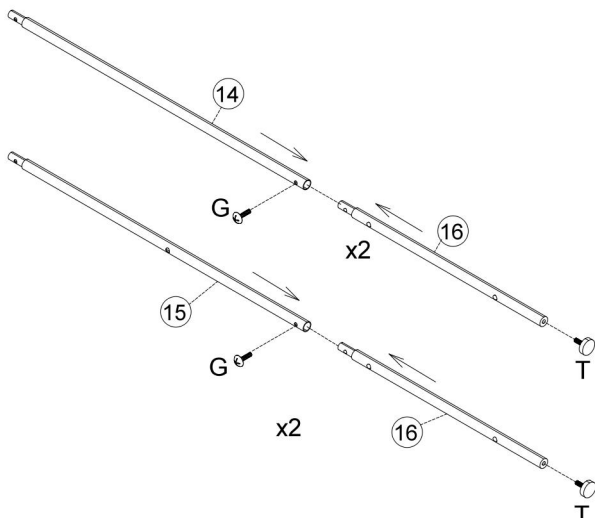

# STEP : 5

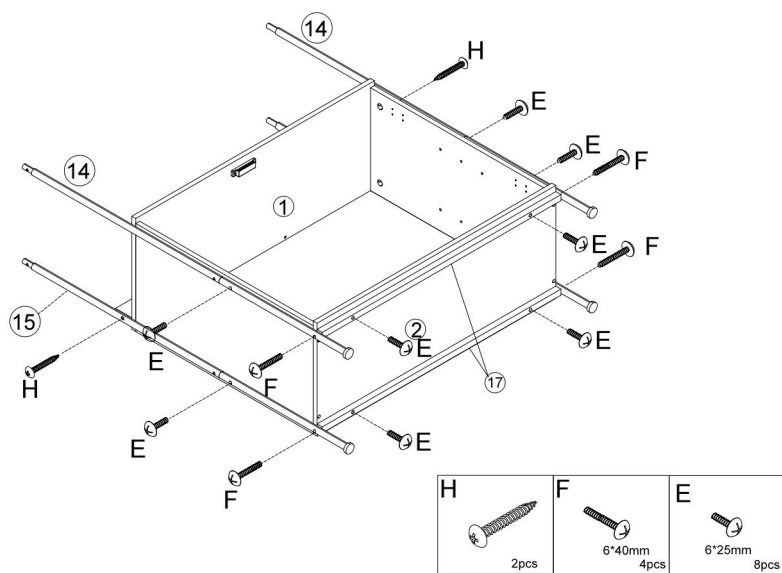

# STEP : 6

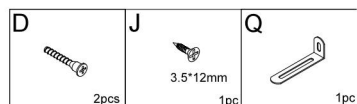
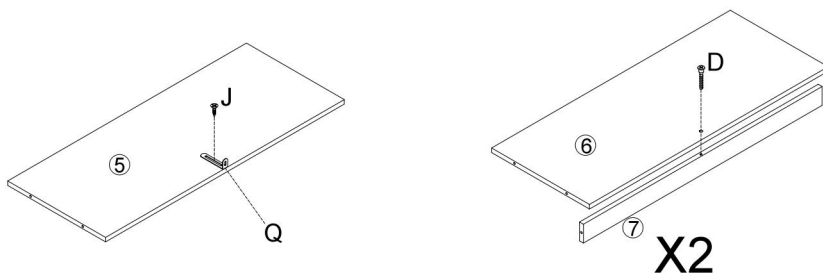

# STEP : 7

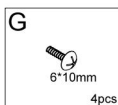
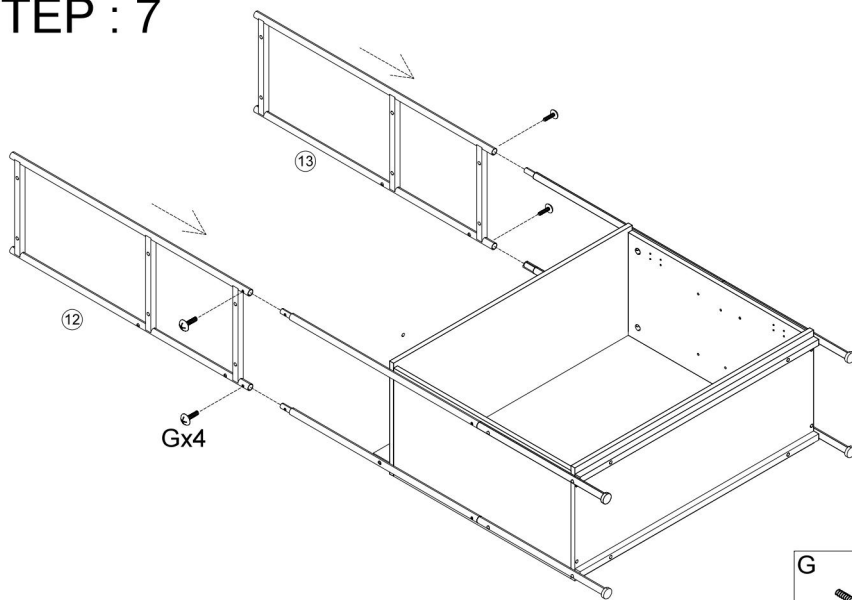



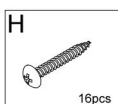
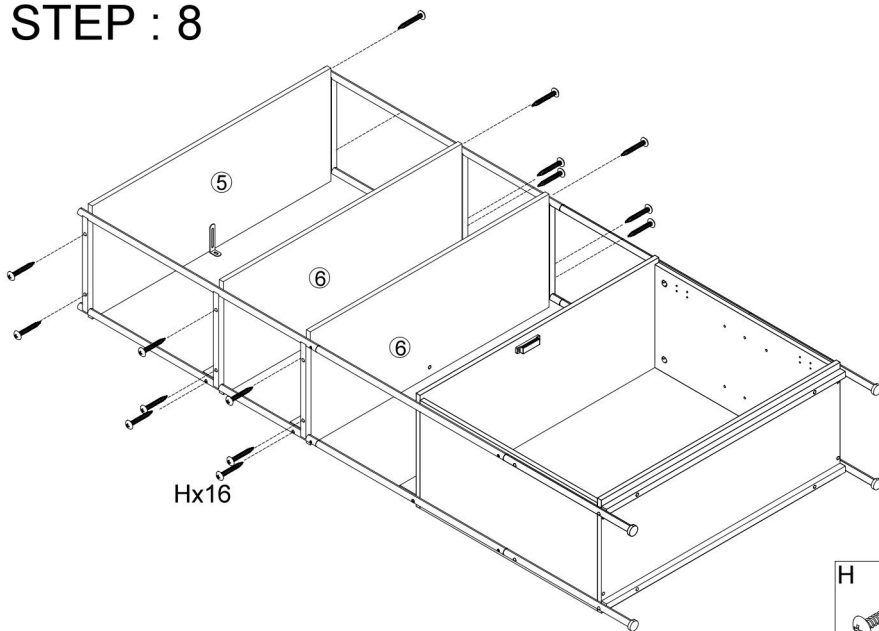

# STEP : 8

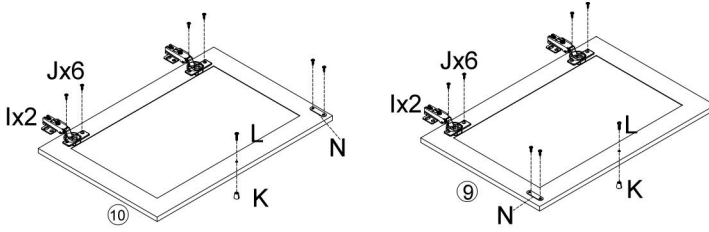





# STEP : 9

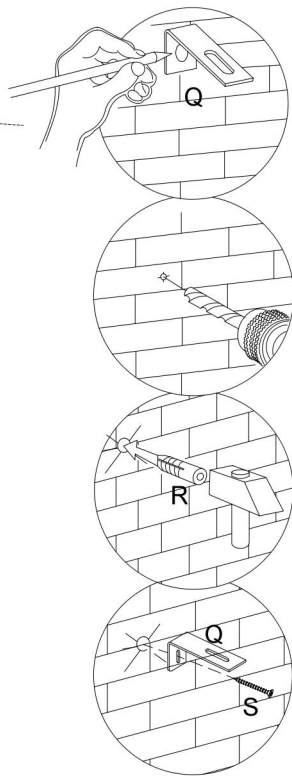
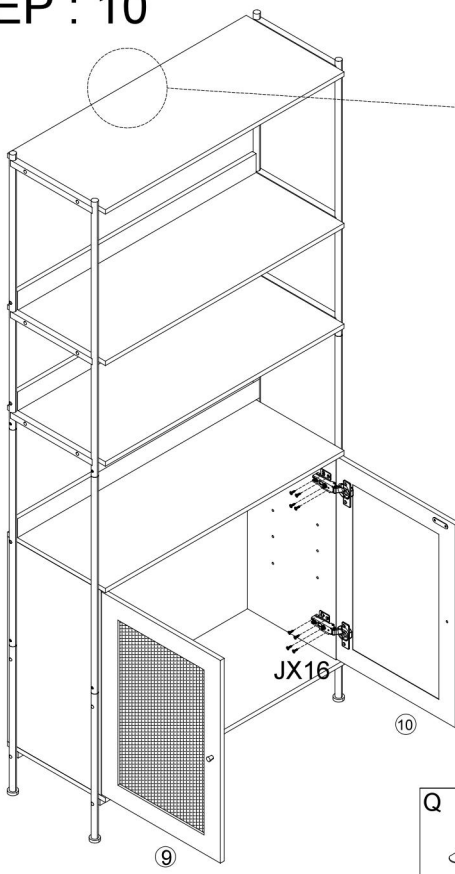

N	J	I	L	K
				
2pcs	3.5*12mm 12pcs	4pcs	2pcs	2pcs

# STEP : 10



Q	S	R	J
			
1pc	4*30mm 16pcs	1pc	1pc



# STEP : 11

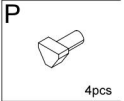
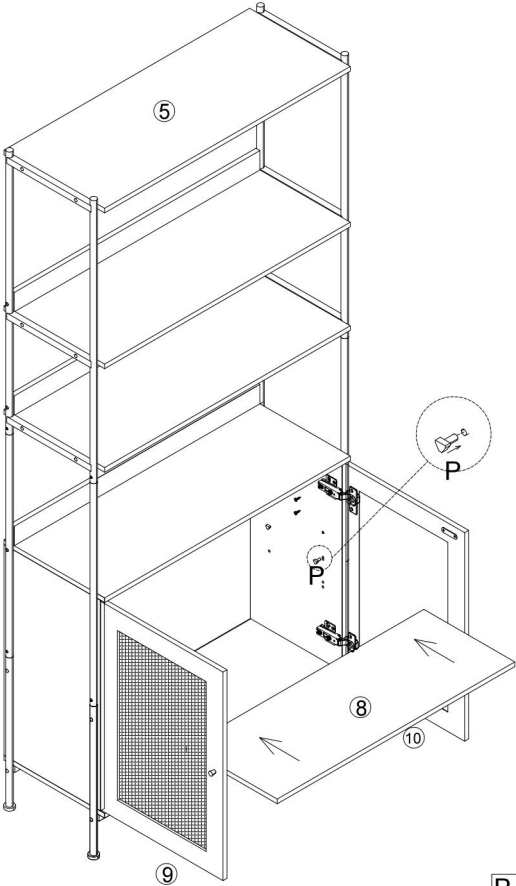

## COMPLETION

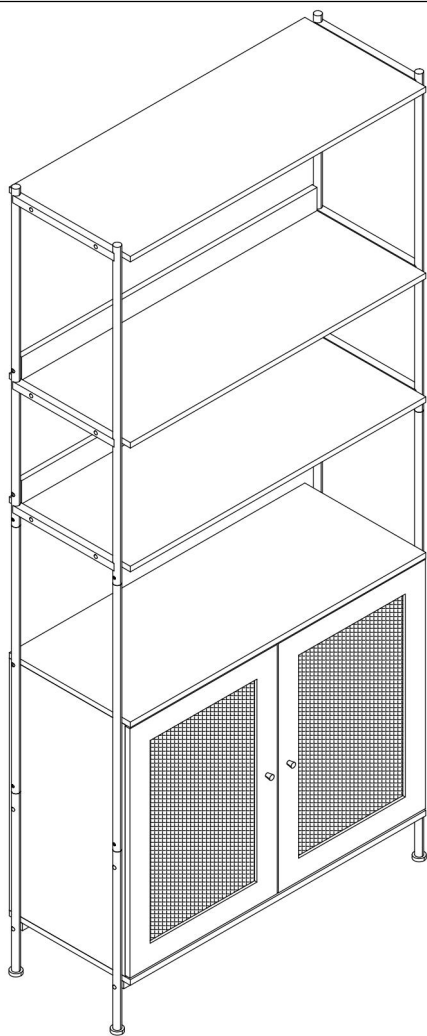

## WARNING



Children have died from furniture tipover. To reduce the risk of furniture tipover:

- ALWAYS install tipover restraint provided.
- NEVER put a TV on this product.
- NEVER allow children to stand, climb or hang on drawers, doors, or shelves.
- NEVER open more than one drawer at a time.
- Place heaviest items in the lowest drawers.

**Producent:** Shanghai muxinmuyeyouxiangongsi

**Adres:** Shuangchenglu 803nong11hao1602A-1609shi, baoshanqu, szanghaj 200000 CN.

**Importowane do AUS:** SIHAO PTY LTD. 1 ROKEVA  
STREETEASTWOOD NSW 2122 Australia

**Importowane do USA:** Sanven Technology Ltd. Suite 250, 9166 Anaheim  
Place, Rancho Cucamonga, CA 91730

<b>EC</b>	<b>REP</b>
-----------	------------

E-CrossStu GmbH  
Mainzer Landstr.69, 60329 Frankfurt am Main.

<b>UK</b>	<b>REP</b>
-----------	------------

YH CONSULTING LIMITED.  
C/O YH Consulting Limited Office 147, Centurion  
House, London Road, Staines-upon-Thames, Surrey,  
TW18 4AX

# VEVOR<sup>®</sup>

**TOUGH TOOLS, HALF PRICE**

**Techniczny Wsparcie i certyfikat e-gwarancji**

[www.vevor.com/support](http://www.vevor.com/support)

# **VEVOR<sup>®</sup>**

**TOUGH TOOLS, HALF PRICE**

Technisch Ondersteuning en E-garantiecertificaat [www.vevor.com/support](http://www.vevor.com/support)

## **ROTAN BOEKENPLANKEN**

### **GEBRUIKSAANWIJZING**

**MODELNUMMER: HY-BTJ-008**

Wij streven er voortdurend naar om u gereedschappen tegen concurrerende prijzen te leveren.

"Bespaar de helft", "halve prijs" of andere soortgelijke uitdrukkingen die alleen door ons worden gebruikt

geeft een schatting van de besparingen die u kunt behalen door bepaalde gereedschappen te kopen

bij ons vergeleken met de grote topmerken en betekent niet per se dat omslag alle categorieën van tools die wij aanbieden. U wordt vriendelijk verzocht om te verifiëren voorzichtig

wanneer u een bestelling bij ons plaatst, als u daadwerkelijk Besparing  
Half in vergelijking met de grote topmerken.

# VEVOR®

TOUGH TOOLS, HALF PRICE

## Rattan Bookshelves

MODELNUMMER: HY-BTJ-008

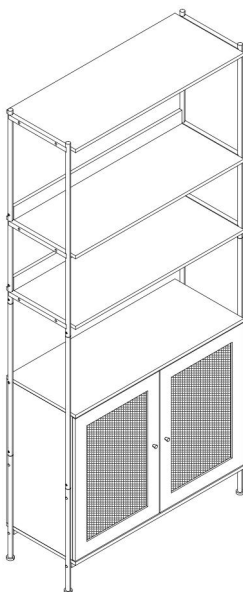

### HULP NODIG? NEEM CONTACT MET ONS OP!

Heeft u vragen over het product? Heeft u technische ondersteuning nodig? Neem dan gerust contact met ons op:

**Technische ondersteuning en e-garantiecertificaat**  
**[www.vevor.com/support](http://www.vevor.com/support)**

Dit is de originele instructie, lees alle handleidingen zorgvuldig door voordat u het product gebruikt. VEVOR behoudt zich een duidelijke interpretatie van onze gebruikershandleiding voor. Het uiterlijk van het product is afhankelijk van het product dat u hebt ontvangen. Vergeef ons dat we u niet opnieuw zullen informeren als er technologie- of software-updates voor ons product zijn .

## **WAARSCHUWING:**

**Lees deze handleiding zorgvuldig door voordat u het product gebruikt. Als u dit niet doet, kan dit leiden tot ernstig letsel.**



Please read and observe carefully all the assembly instructions before beginning assembly.



Unit should be assembled by two or more people.



**DO NOT CLIMB**

Please do not let your child climb on the product. If you have kids or animals who like to climb, we highly recommend using the wall anchors and brackets/straps that come with the package.

## **MONTAGEVOORZORGSMATREGELEN**

49. Monteer alleen volgens deze instructies. Onjuiste montage kan gevaren opleveren.
50. Draag tijdens de montage een ANSI-goedgekeurde veiligheidsbril en stevige werkhandschoenen.
51. Zorg ervoor dat de verzamelplaats schoon en goed verlicht is.
52. Houd omstanders uit de buurt tijdens de montage.
53. Kom niet bijeen als u moe bent of onder invloed van alcohol, drugs of medicijnen.
54. De producteigenschappen gelden uitsluitend voor correct en volledig gemonteerde producten.

55. Monteer de rieten boekenplanken op een vlak, egaal, hard en glad oppervlak dat de rieten boekenplanken veilig kan dragen.

56. Voor aanvullende informatie over de onderdelen die op de volgende pagina's worden vermeld, raadpleegt u het montageschema van deze handleiding. Pak alle onderdelen uit en scheid ze in een schone werkruimte.

BEWAAR DEZE INSTRUCTIES

## GEBRUIK VOORZORGSMAATREGELEN

**OM ERNSTIG LETSEL EN DE DOOD DOOR FOUTEN TE VOORKOMEN:**

25. Dit product is geen speelgoed. Laat kinderen niet met of in de buurt van dit artikel spelen.

26. Overschrijd het toegestane gewicht niet voordat u het verplaatst.

27. Gebruik de plank alleen op een vlak, hard en glad oppervlak dat een volledig gevulde Rattan Boekenplank veilig kan dragen.

28. Alleen gebruiken zoals bedoeld.

Controleer het product voor elk gebruik. Gebruik het niet als er onderdelen loszitten of beschadigd zijn.

### TECHNICAL SPECIFICATIONS







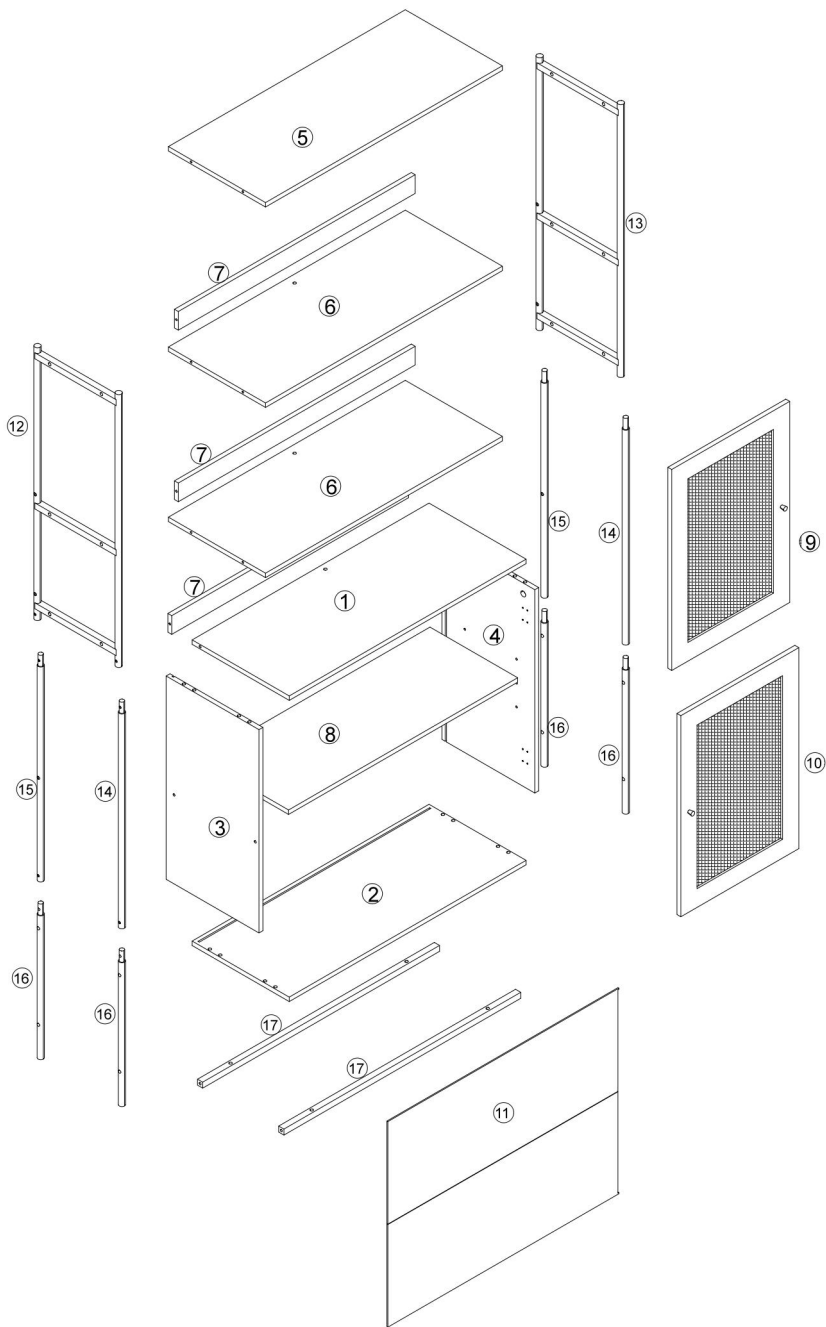

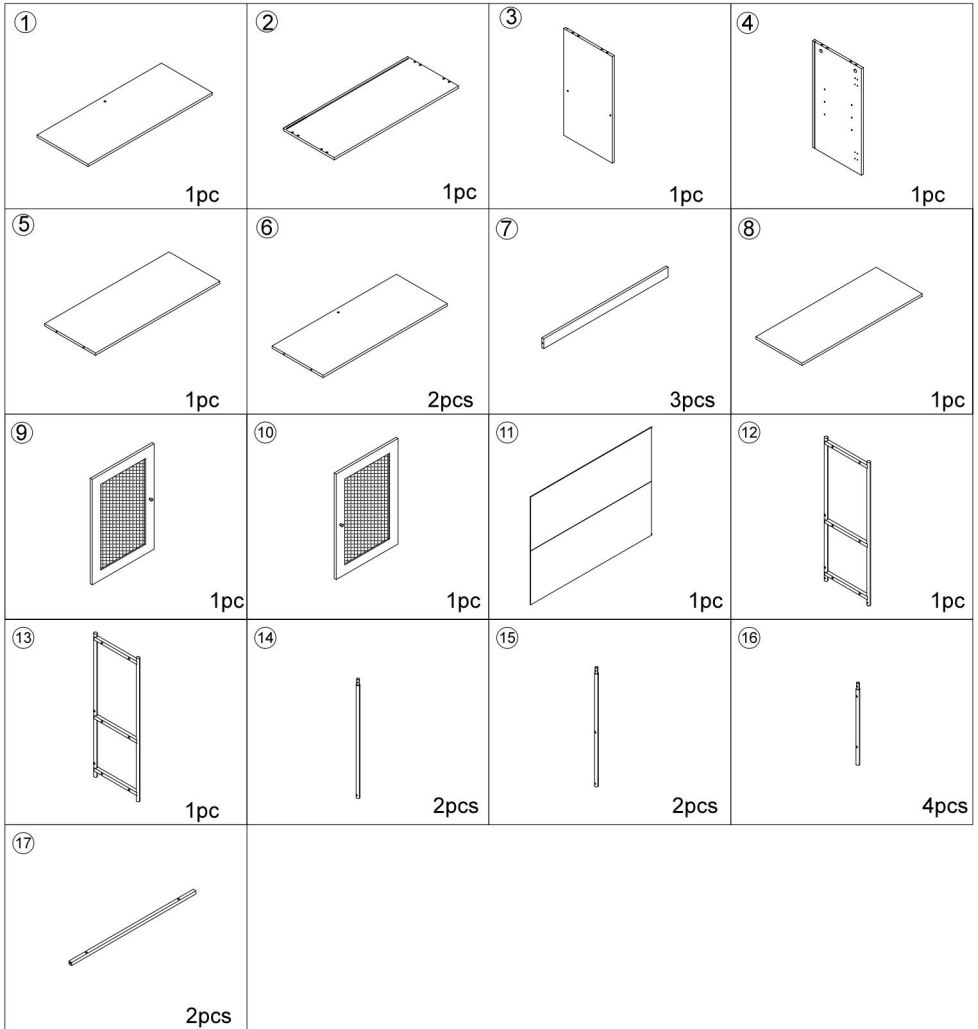









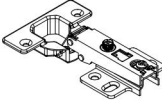

Model	HY-BTJ-008
Productafmetingen (LxBxH)(mm)	764*300*1747
Nettogewicht (kg)	Ongeveer 21

\*Productspecificaties, uiterlijk en ontwerp kunnen zonder voorafgaande kennisgeving worden gewijzigd.

## **PACKAGE CONTENTS**

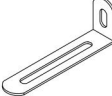







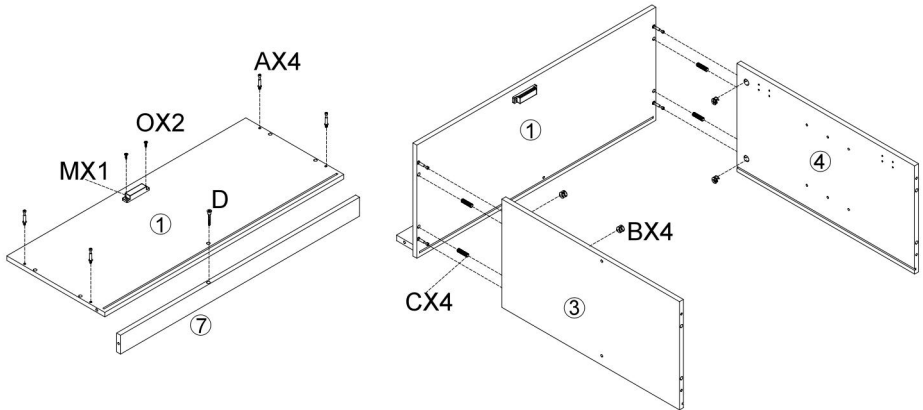

<p><b>A</b></p>  <p>4pcs</p>	<p><b>B</b></p>  <p>4pcs</p>	<p><b>C</b></p>  <p>8pcs</p>	<p><b>D</b></p>  <p>7pcs+1pc</p>
<p><b>E</b></p>  <p>6*25mm 8pcs+1pc</p>	<p><b>F</b></p>  <p>6*40mm 4pcs</p>	<p><b>G</b></p>  <p>6*10mm 8pcs+1pc</p>	<p><b>H</b></p>  <p>18pcs+1pc</p>
<p><b>I</b></p>  <p>4pcs</p>	<p><b>J</b></p>  <p>3.5*12mm 29pcs+2pcs</p>	<p><b>K</b></p>  <p>2pcs</p>	<p><b>L</b></p>  <p>2pcs</p>
<p><b>M</b></p>  <p>1pc</p>	<p><b>N</b></p>  <p>2pcs</p>	<p><b>O</b></p>  <p>3*14mm 2pcs</p>	<p><b>P</b></p>  <p>4pcs</p>
<p><b>Q</b></p>  <p>1pc</p>	<p><b>R</b></p>  <p>1pc</p>	<p><b>S</b></p>  <p>4*30mm 1pc</p>	<p><b>T</b></p>  <p>4pcs</p>

# ASSEMBLY STEPS

## STEP : 1



D	B	C	A	M	O
					
1pc	4pcs	4pcs	4pcs	1pc	3*14mm 2pcs

## STEP : 2

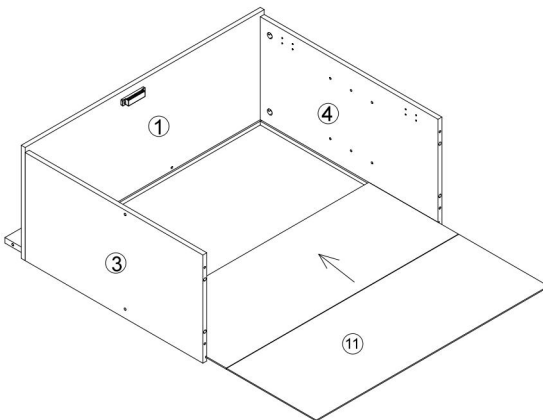

# STEP : 3

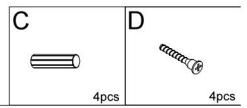
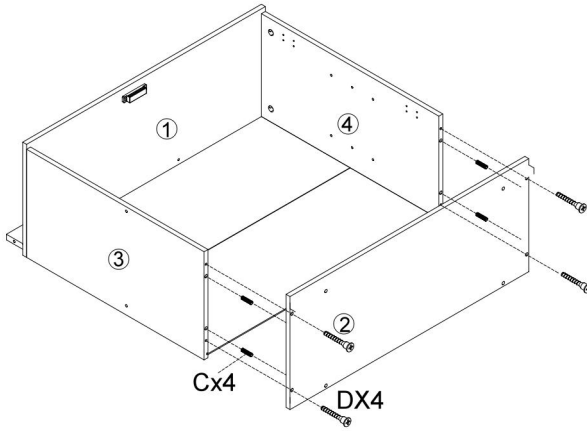

# STEP : 4

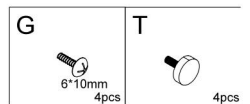
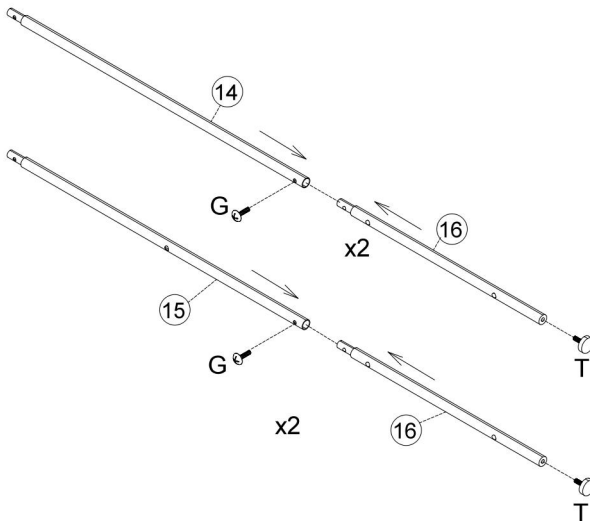

# STEP : 5

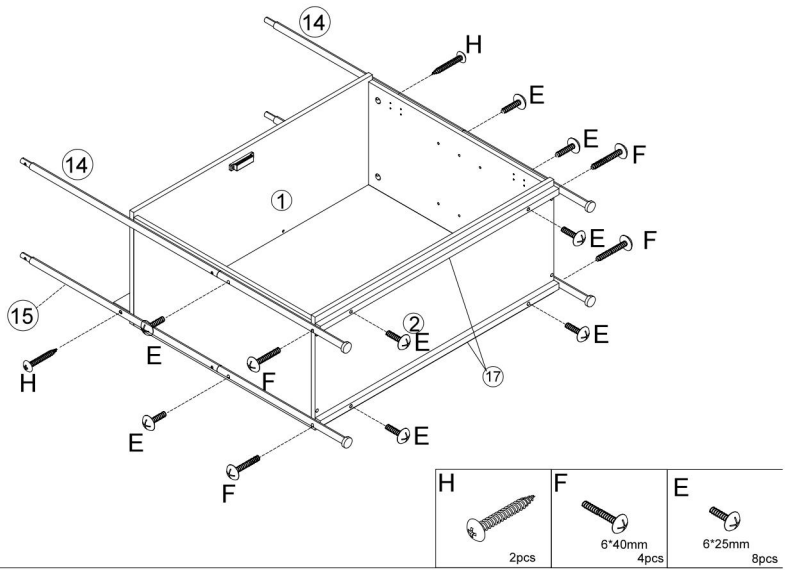

# STEP : 6

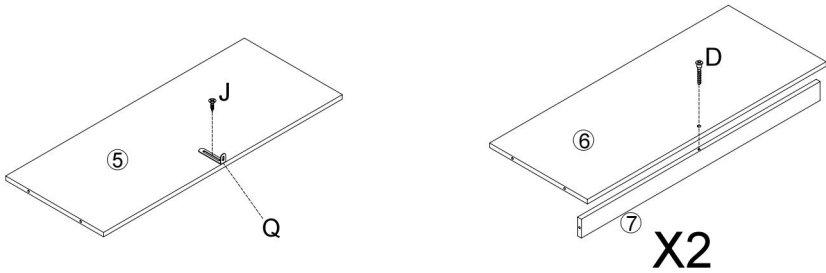

**X2**



# STEP : 7

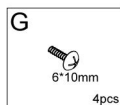
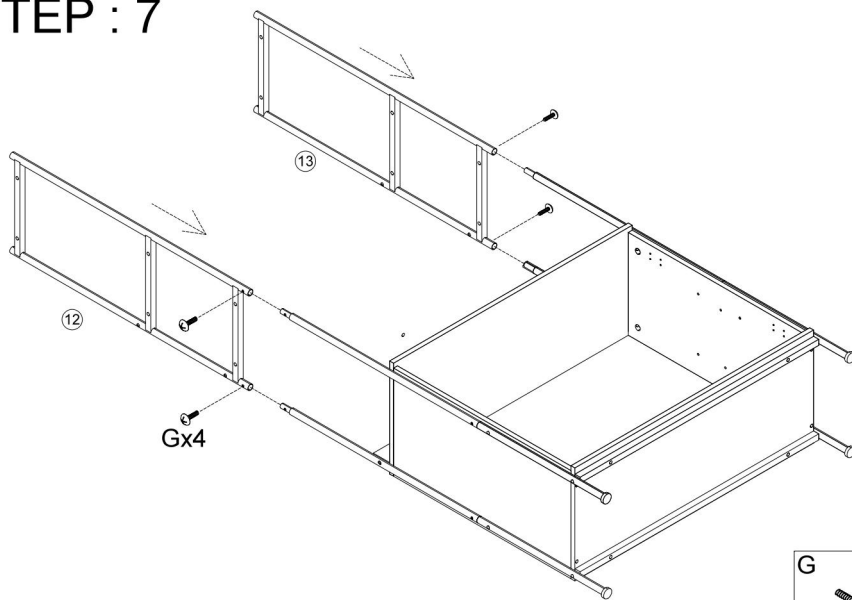



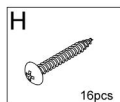
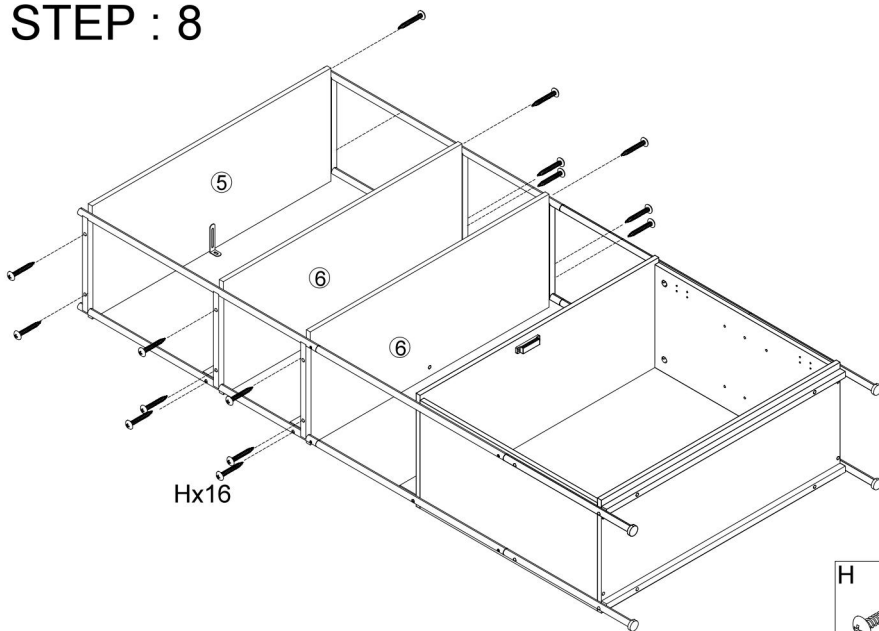

# STEP : 8

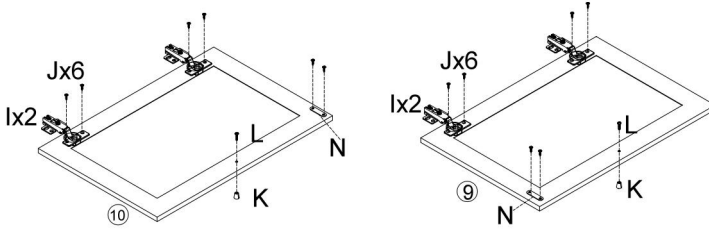





# STEP : 9

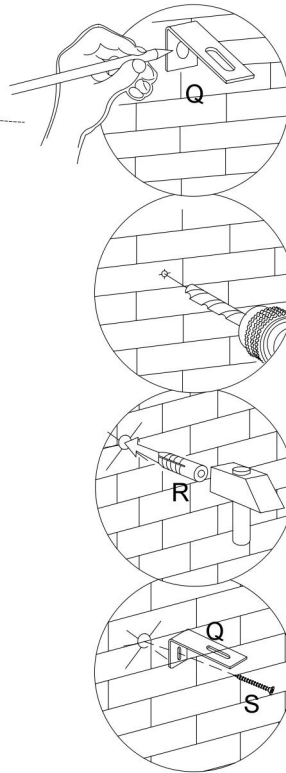
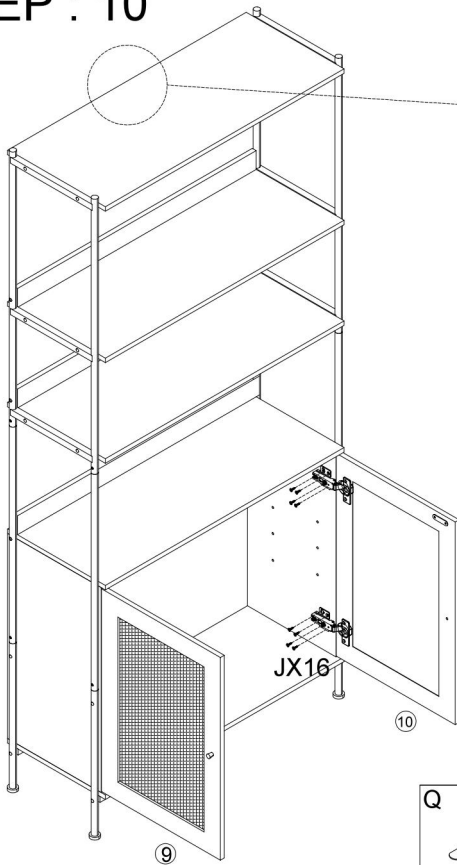

N	J	I	L	K
				
2pcs	3.5*12mm 12pcs	4pcs	2pcs	2pcs

# STEP : 10



Q	S	R	J
			
1pc	4*30mm 16pcs	1pc	1pc

# STEP : 11

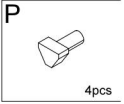
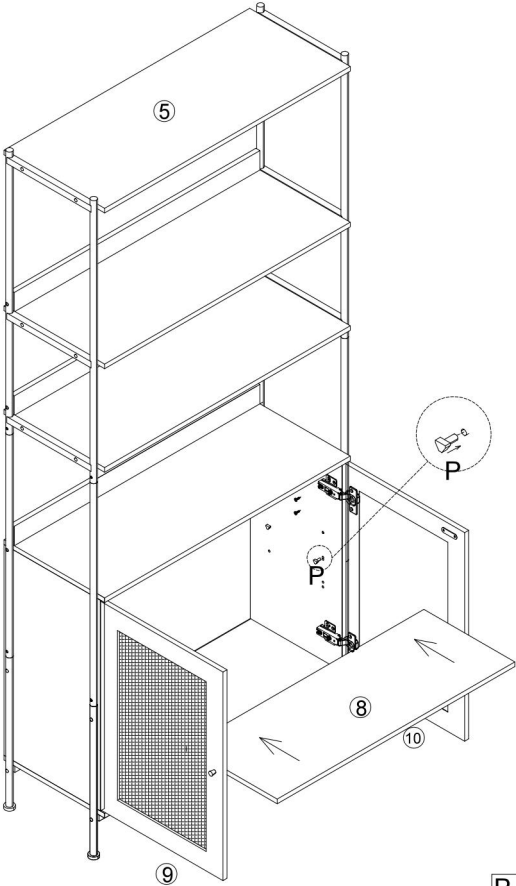

## COMPLETION

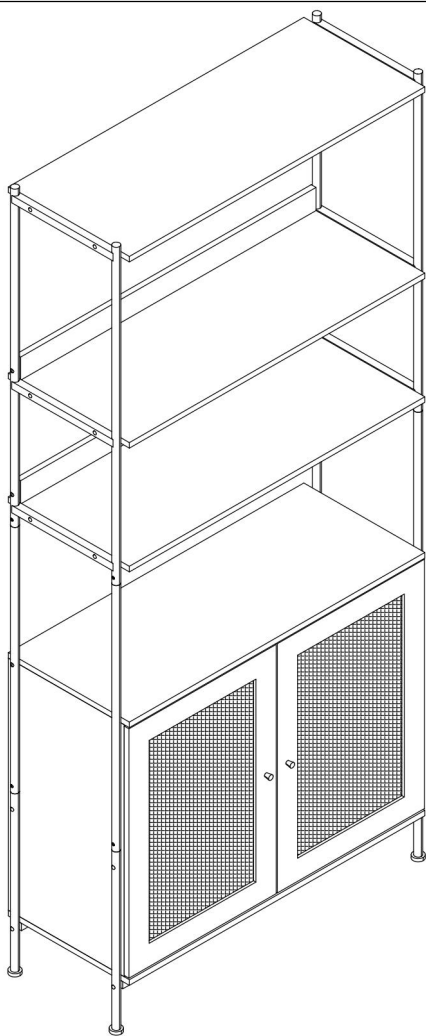

## WARNING



Children have died from furniture tipover. To reduce the risk of furniture tipover:

- ALWAYS install tipover restraint provided.
- NEVER put a TV on this product.
- NEVER allow children to stand, climb or hang on drawers, doors, or shelves.
- NEVER open more than one drawer at a time.
- Place heaviest items in the lowest drawers.

**Fabrikant:** Shanghaimuxinmuyeyouxiangongsi

**Adres:** Shuangchenglu 803nong11hao1602A-1609shi, baoshanqu, shanghai 200000 CN.

**Geïmporteerd naar AUS:** SIHAO PTY LTD. 1 ROKEVA  
STREETEASTWOOD NSW 2122 Australië

**Geïmporteerd naar de VS:** Sanven Technology Ltd. Suite 250, 9166  
Anaheim Place, Rancho Cucamonga, CA 91730

<b>EC</b>	<b>REP</b>
-----------	------------

E-CrossStu GmbH  
Mainzer Landstr.69, 60329 Frankfurt am Main.

<b>UK</b>	<b>REP</b>
-----------	------------

YH CONSULTING LIMITED.  
C/O YH Consulting Limited Office 147, Centurion  
House, London Road, Staines-upon-Thames, Surrey,  
TW18 4AX

# VEVOR®

**TOUGH TOOLS, HALF PRICE**

**Technisch Ondersteuning en E-garantiecertificaat**

[www.vevor.com/support](http://www.vevor.com/support)

# **VEVOR<sup>®</sup>**

**TOUGH TOOLS, HALF PRICE**

Teknisk Support och e-garanticertifikat [www.vevor.com/support](http://www.vevor.com/support)

## **ROTTING BOKHYLLOR**

### **A R MANUAL**

**MODELLNR: HY-BTJ-008**

Vi fortsätter att vara engagerade i att ge dig verktyg till konkurrenskraftiga priser. "Spara hälften", "Halva priset" eller andra liknande uttryck som endast används av oss representerar en uppskattning av besparingar du kan dra nytta av att köpa vissa verktyg med oss jämfört med de stora toppmärkena och betyder inte nödvändigtvis att täcka alla kategorier av verktyg som erbjuds av oss. Du påminns vänligen om att verifiera försiktigt

när du gör en beställning hos oss om du faktiskt gör det Sparande Halv i jämförelse med de främsta varumärkena.

# VEVOR®

TOUGH TOOLS, HALF PRICE

## Rattan Bookshelves

MODELLNR: HY-BTJ-008

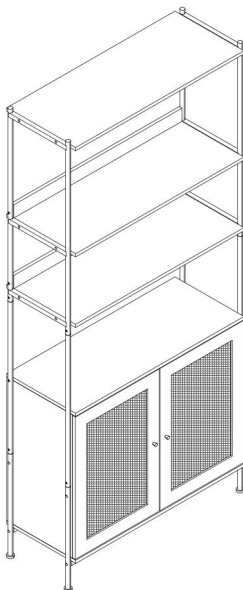

### BEHÖVER HJÄLP? KONTAKTA OSS!

Har du produktfrågor? Behöver du teknisk support? Kontakta oss gärna:

**Teknisk support och e-garanticertifikat**  
**[www.vevor.com/support](http://www.vevor.com/support)**

Detta är den ursprungliga instruktionen, läs alla instruktioner noggrant innan du använder den. VEVOR reserverar sig för en tydlig tolkning av vår användarmanual. Utseendet på produkten är beroende av den produkt du fått. Ursäkta oss att vi inte kommer att informera dig igen om det finns någon teknik eller mjukvaruuppdateringar på vår produkt.

 **WARNING:**

**Läs denna bruksanvisning noggrant innan du använder produkten. Underlåtenhet att göra det kan leda till allvarliga skador.**



Please read and observe carefully all the assembly instructions before beginning assembly.



Unit should be assembled by two or more people.



DO NOT CLIMB

Please do not let your child climb on the product. If you have kids or animals who like to climb, we highly recommend using the wall anchors and brackets/straps that come with the package.

## **FÖRSIKTIGHETSÅTGÄRDER FÖR MONTERING**

57. Montera endast enligt dessa instruktioner. Felaktig montering kan skapa faror.
58. Använd ANSI-godkända skyddsglasögon och kraftiga arbetshandskar vid montering.
59. Håll monteringsområdet rent och väl upplyst.
60. Håll åskådare borta från området under monteringen.
61. Sätt dig inte ihop när du är trött eller påverkad av alkohol, droger eller mediciner.

62. Produkttegenskaperna gäller endast för korrekt och färdigmonterade produkter.

63. Montera på en plan, jämn, hård och slät yta som säkert kan stödja Rottingbokhyllorna.

64. För ytterligare information om delarna som listas på följande sidor, se monteringsdiagrammet i denna manual. Packa upp och separera alla delar på ett rent arbetsområde.

SPARA DESSA E INSTRUKTIONER

## **ANVÄND FÖRSIKTIGHETSÅTGÄRDER**

**FÖR ATT FÖRHINDRA ALLVARLIGA SKADA OCH DÖDSFALL VID VÄLLNING:**

29. Denna produkt är inte en leksak. Tillåt inte barn att leka med eller i närheten av detta föremål.

30. Överskrid inte viktkapaciteten innan du flyttar.

31. Använd endast på en plan, hård och slät yta som säkert kan stödja en fullastad rottingbokhyllor.

32. Använd endast som avsett.

Inspektera före varje användning; Använd inte om delar är lösa eller skadade.

### **TECHNICAL SPECIFICATIONS**

Modell	HY-BTJ-008
Produktens mått (LxBxH)(mm)	764*300*1747







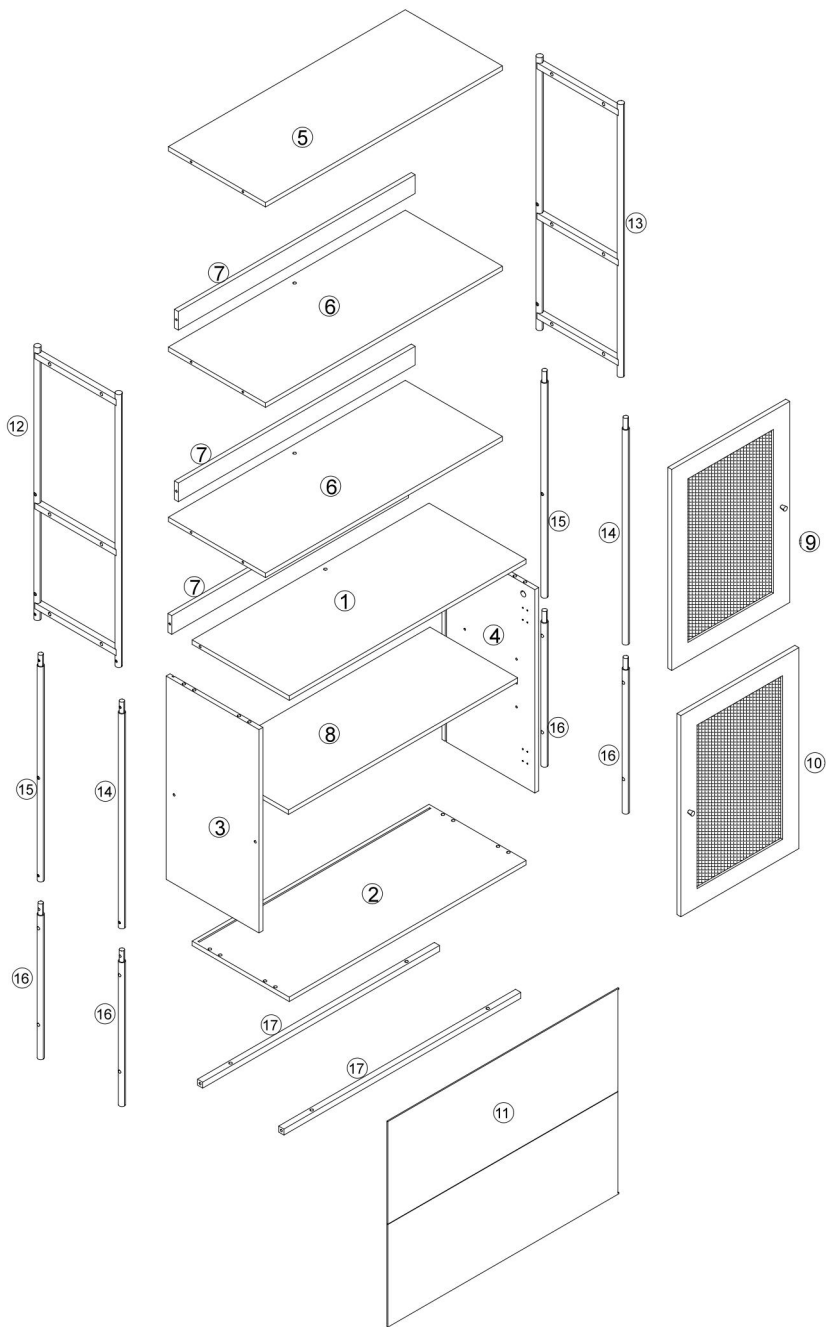

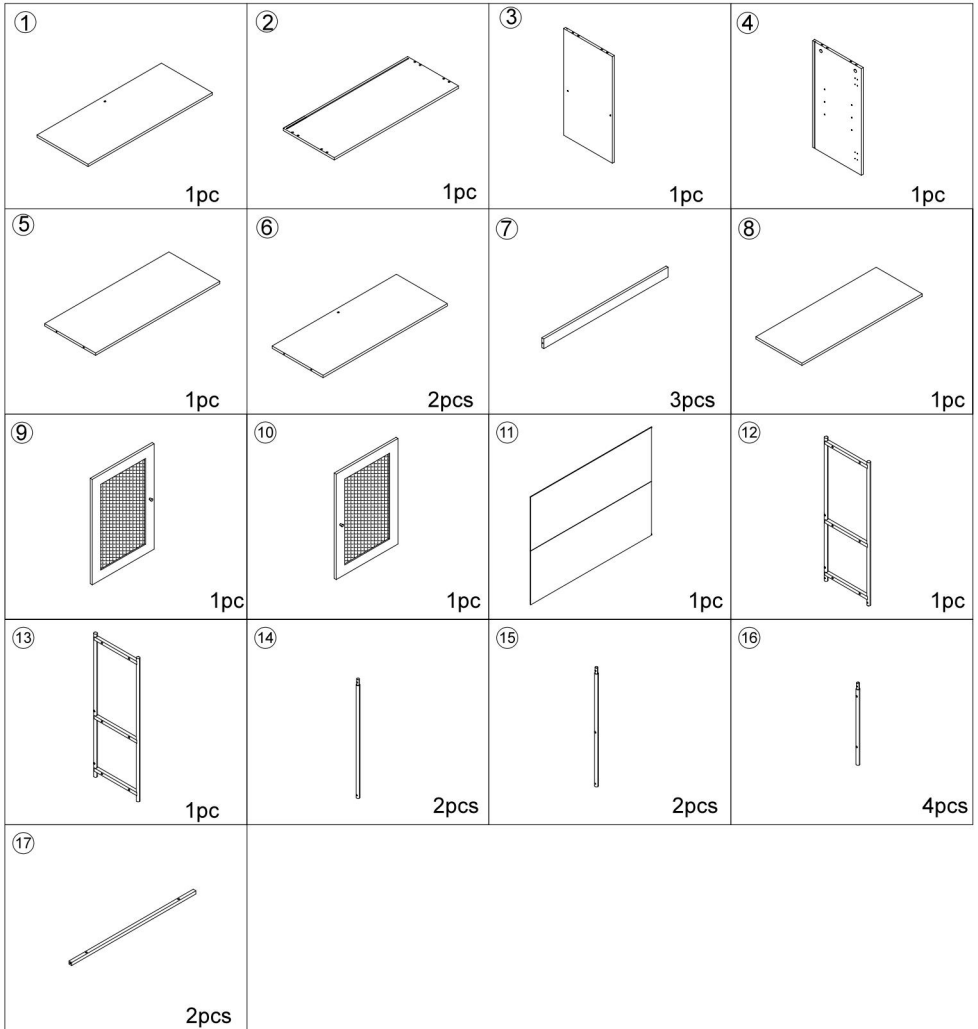









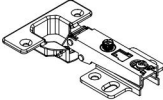

Nettovikt (kg)	Cirka 21
----------------	----------

\*Produkter som specifikationer, utseende och design kan ändras utan föregående meddelande.

## **PACKAGE CONTENTS**









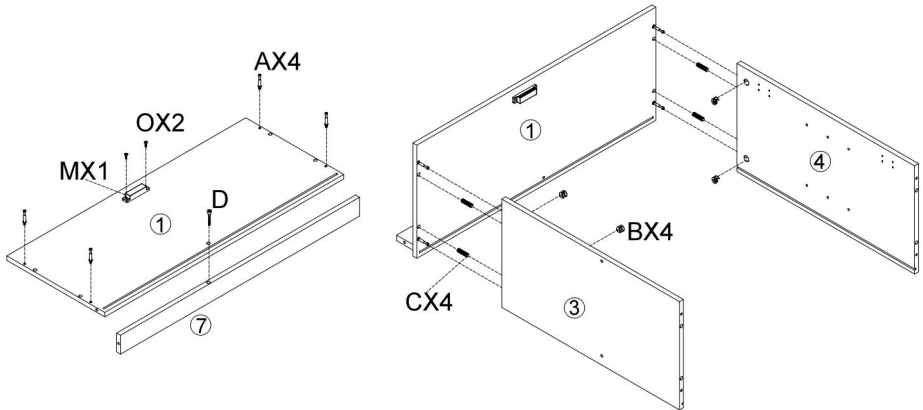

<p><b>A</b></p>  <p>4pcs</p>	<p><b>B</b></p>  <p>4pcs</p>	<p><b>C</b></p>  <p>8pcs</p>	<p><b>D</b></p>  <p>7pcs+1pc</p>
<p><b>E</b></p>  <p>6*25mm 8pcs+1pc</p>	<p><b>F</b></p>  <p>6*40mm 4pcs</p>	<p><b>G</b></p>  <p>6*10mm 8pcs+1pc</p>	<p><b>H</b></p>  <p>18pcs+1pc</p>
<p><b>I</b></p>  <p>4pcs</p>	<p><b>J</b></p>  <p>3.5*12mm 29pcs+2pcs</p>	<p><b>K</b></p>  <p>2pcs</p>	<p><b>L</b></p>  <p>2pcs</p>
<p><b>M</b></p>  <p>1pc</p>	<p><b>N</b></p>  <p>2pcs</p>	<p><b>O</b></p>  <p>3*14mm 2pcs</p>	<p><b>P</b></p>  <p>4pcs</p>
<p><b>Q</b></p>  <p>1pc</p>	<p><b>R</b></p>  <p>1pc</p>	<p><b>S</b></p>  <p>4*30mm 1pc</p>	<p><b>T</b></p>  <p>4pcs</p>

# ASSEMBLY STEPS

## STEP : 1



D	B	C	A	M	O
					
1pc	4pcs	4pcs	4pcs	1pc	3*14mm 2pcs

## STEP : 2

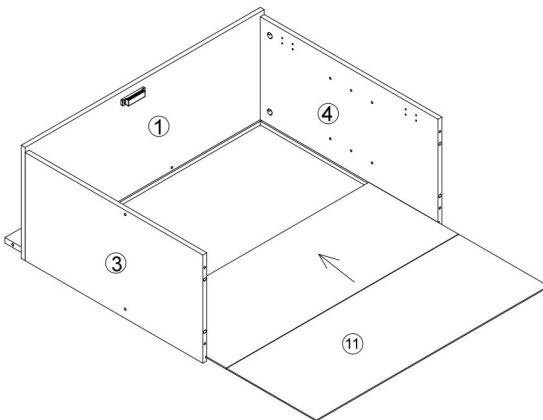

# STEP : 3

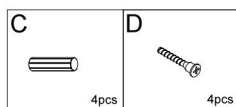
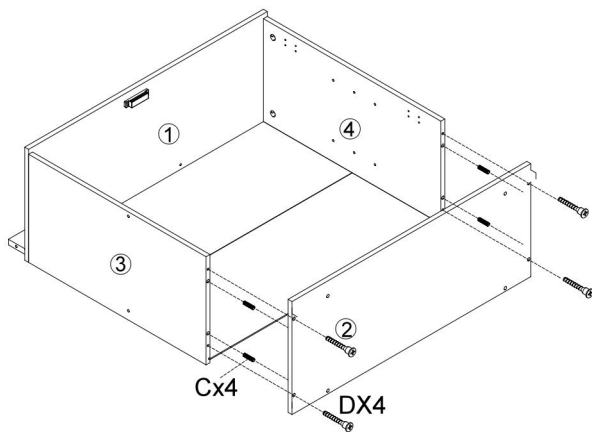

# STEP : 4

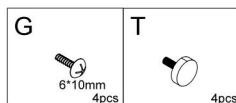
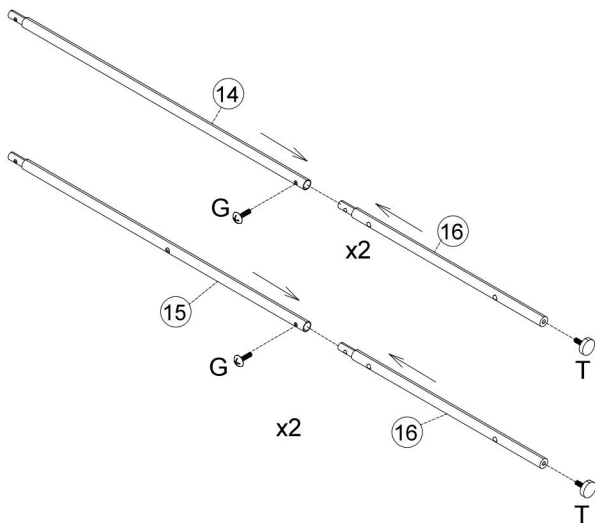

# STEP : 5

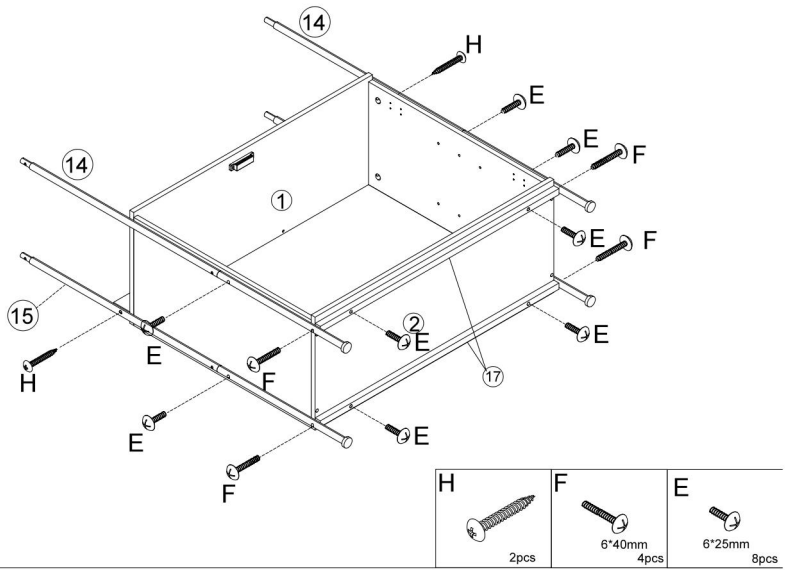

# STEP : 6

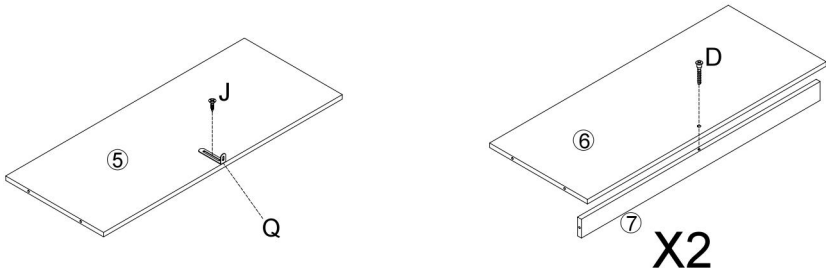

# STEP : 7

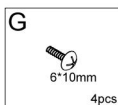
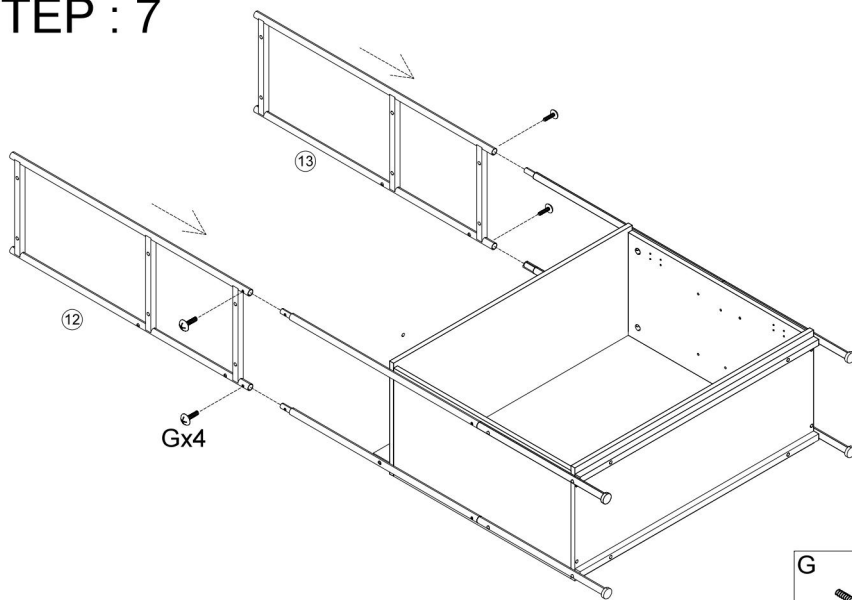

# STEP : 8

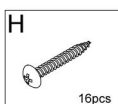
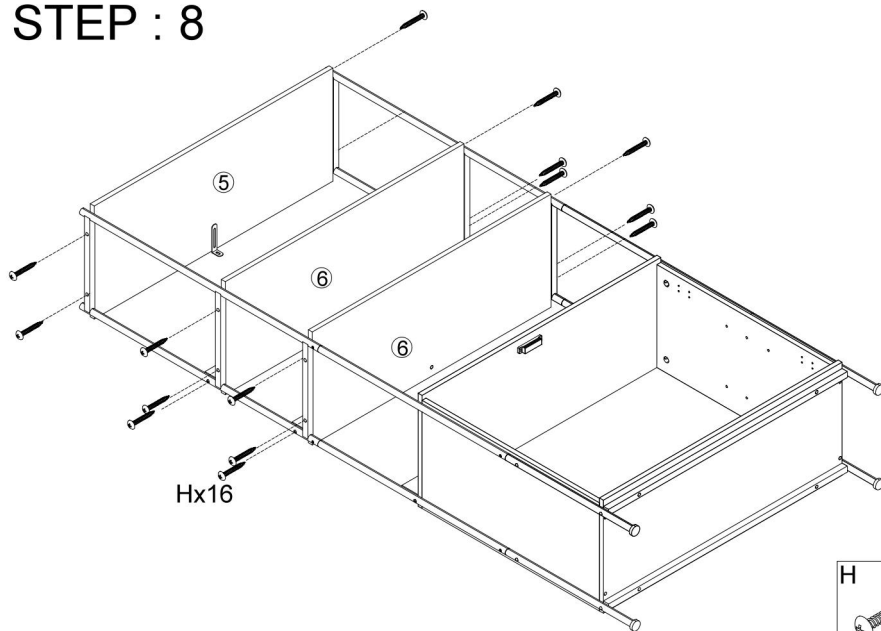

# STEP : 9

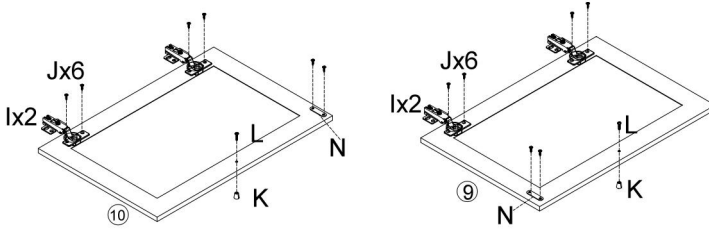

N	J	I	L	K
2pcs	3.5*12mm 12pcs	4pcs	2pcs	2pcs

# STEP : 10

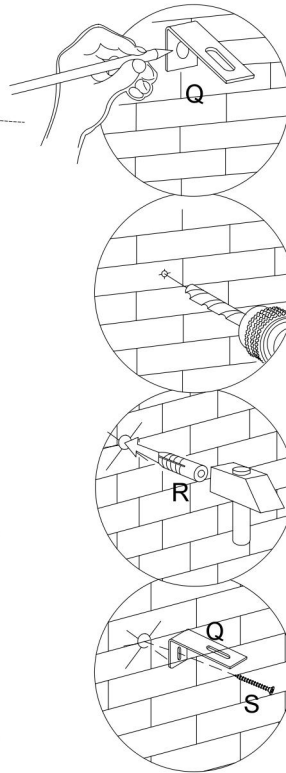
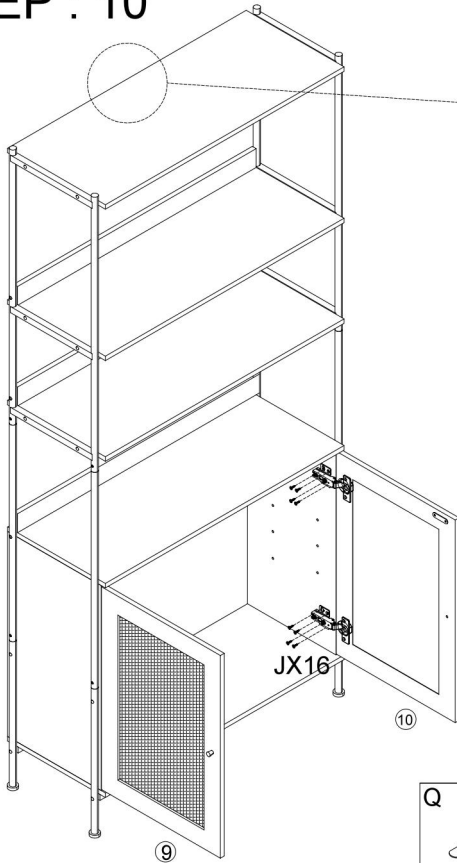

Q	S	R	J
1pc	4*30mm	1pc	3.5*12mm 16pcs

# STEP : 11

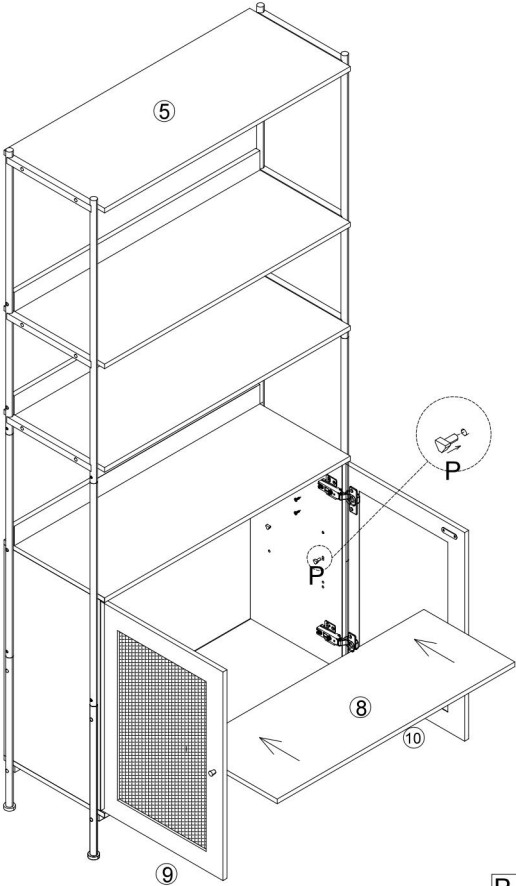

**P**

4pcs



## COMPLETION

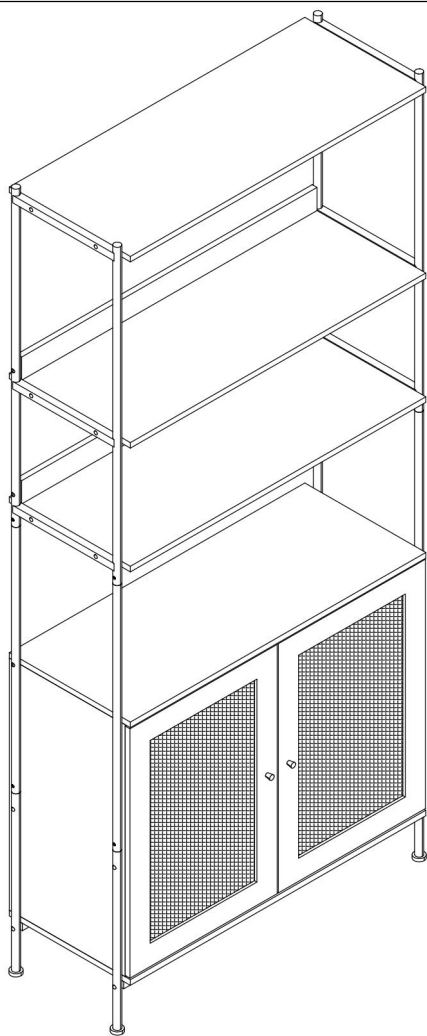

## WARNING



Children have died from furniture tipover. To reduce the risk of furniture tipover:

- ALWAYS install tipover restraint provided.
- NEVER put a TV on this product.
- NEVER allow children to stand, climb or hang on drawers, doors, or shelves.
- NEVER open more than one drawer at a time.
- Place heaviest items in the lowest drawers.

**Tillverkare:** Shanghaimuxinmuyeyouxiangongsi

**Adress:** Shuangchenglu 803nong11hao1602A-1609shi, baoshanqu, shanghai 200000 CN.

**Importerad till AUS:** SIHAO PTY LTD. 1 ROKEVA STREETEASTWOOD NSW 2122 Australien

**Importerad till USA:** Sanven Technology Ltd. Suite 250, 9166 Anaheim Place, Rancho Cucamonga, CA 91730

<b>EC</b>	<b>REP</b>
-----------	------------

E-CrossStu GmbH  
Mainzer Landstr.69, 60329 Frankfurt am Main.

<b>UK</b>	<b>REP</b>
-----------	------------

YH CONSULTING LIMITED.  
C/O YH Consulting Limited Office 147, Centurion House, London Road, Staines-upon-Thames, Surrey, TW18 4AX

# VEVOR®

**TOUGH TOOLS, HALF PRICE**

**Teknisk Support och e-garanticertifikat**

[www.vevor.com/support](http://www.vevor.com/support)

