

Proudly distributed by
De'Longhi Australia Pty Limited
P.O. BOX 4540
CASULA MALL NSW 2170
Customer Service Ph: 1800 126 659
Fax: 1800 706932
www.delonghi.com.au
e-mail: info.au@delonghigroup.com

De'Longhi New Zealand Limited
99 Khyber Pass Road
Grafton 1023
Auckland, New Zealand
P.O. Box 58-056 Botany
MANUKAU 2163
Customer Service Ph: 0508 200 300
Fax: 0508 200 301
www.delonghi.co.nz
e-mail: info.nz@delonghigroup.com

Register Now 
www.delonghi.com/register

KBX Series

KETTLE
Instructions for use



DeLonghi

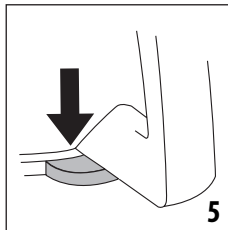
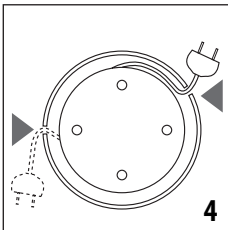
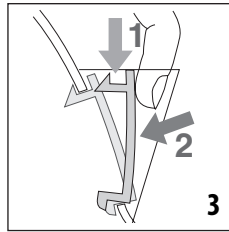
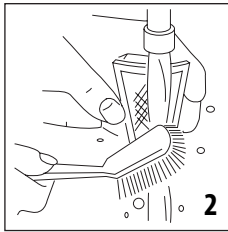
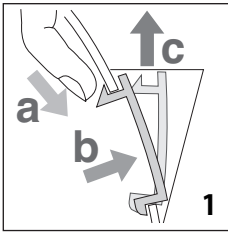
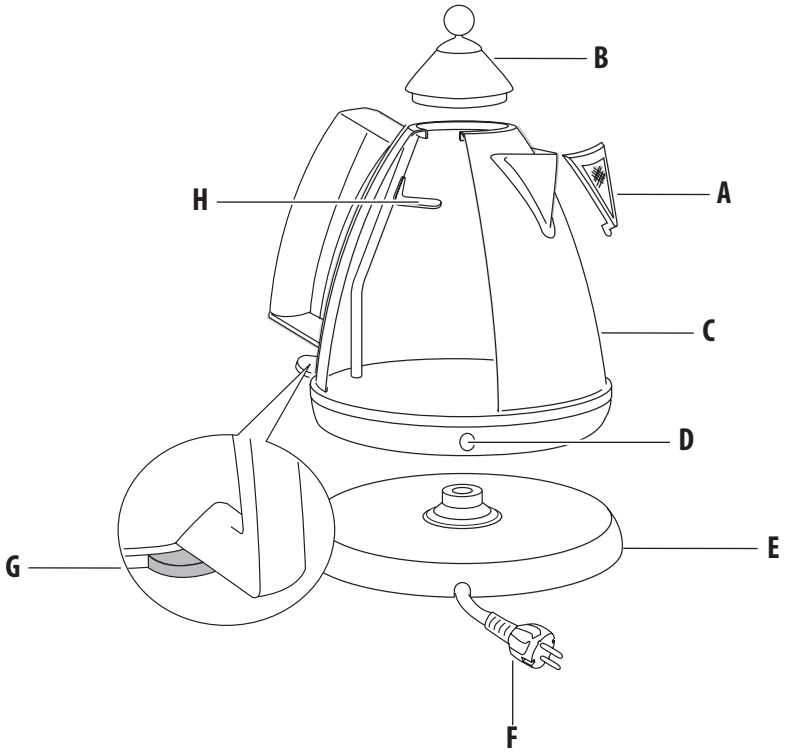

IMPORTANT WARNINGS

Safety warnings



Danger!

Failure to observe the warning may result in life threatening injury by electric shock.

- Avoid spillage on the connector.



Important!

Failure to observe the warning could result in injury or damage to the appliance.

- The appliance is exclusively for the use of boiling water. Any other use is to be considered inappropriate and therefore dangerous. The manufacturer cannot be held responsible for eventual damage caused by inappropriate, improper or irresponsible use and/or for repairs made to the product by unauthorised personnel.
- The appliance is designed and produced for domestic use only. It is not suitable for use in: staff kitchens in shops, offices and other workplaces, farm houses, hotels, motels or other holiday accommodation, guest houses.
- This appliance is not intended for use by persons (including children) with reduced physical, sensory or mental capabilities, or lack of experience and knowledge, unless they have been given supervision or instruction concerning use of the appliance by a person responsible for their safety. Children should be supervised to ensure that they do not play with the appliance.
- The power cable must not be replaced by the user as this requires the use of special tools.

If the supply cord is damaged, it must be replaced by the manufacturer, its service agent or similarly qualified

persons in order to avoid a hazard.

- Use the kettle only with the power base supplied (and vice versa).
- Do not operate the kettle on an inclined surface.
- Do not operate the kettle unless the element is fully immersed.
- To prevent damage to the appliance do not use alkaline cleaning agents when cleaning, use a soft cloth and a mild detergent.
- Do not use the appliance at altitudes exceeding 2000m.
- Details for cleaning refer to cleaning part of user manual.



Danger of burns!!

Failure to observe the warning could result in burns or scalds.

- Do not remove the lid while the kettle is boiling.
- If the kettle is overfilled, boiling water may be ejected.
- The heating element surface is subject to residual heat after use.



Please note:

This symbol indicates recommendations and important information for the user.

- Never move the kettle while it is in use.



Danger!

Failure to observe the warning may result in life threatening injury by electric shock.

- To protect against electrical hazards do not immerse the mains lead, plug power base or kettle in water or any other liquid. Do not use in the bathroom or near any source of water. Do not use outdoors.
- Remove the plug from the mains socket when not in use and before cleaning. Allow the kettle to cool before cleaning.
- Do not use the kettle if you have wet hands.
- Do not store anything into the kettle.

The use of accessory attachments not recommended by the appliance manufacturer may result in fire, electric shock or personal injury.



Important!

Failure to observe the warning could result in injury or damage to the appliance.

- Take care when pouring - do not over-tilt the kettle as water may enter into the switch mechanism.
- Close supervision is necessary when any appliance is used near children.
- Do not operate this kettle if the mains lead or plug is damaged, if the kettle malfunctions, or has been damaged in any manner.

It must be returned to an authorised service agent for repair or replacement in order to avoid hazard.



Danger of burns!!

Failure to observe the warning could result in burns or scalds.

- Do not touch hot surfaces i.e. body or lid. Use handles or knobs.
- Water can remain hot for a long time after boiling and can present a scald hazard.
Keep the kettle and the mains lead away from the edge of the work surface and out of the reach of children.
- Do not allow the mains lead to hang over the edge of the table or work surface.
- Avoid contact with steam coming out of the spout when pouring, and out of the lid or spout when refilling.
- Never put the kettle, its base or cord near or on cooker, hot plates or gas burners.



Please note:

This symbol indicates recommendations and important information for the user.

- Remove the kettle from its power base before filling.
- Do not use the kettle for any purpose other than heating water.
- De'Longhi will not accept any liability if the appliance is subject to improper use, or failure to comply with these instructions.
- Never use the kettle without its lid and filter (kettle may not switch off).
- Position the kettle properly on the power base before switching on.



This appliance conforms to EC Regulation 1935/2004 on materials and articles intended to come into contact with food.

DESCRIPTION

- A** Removable filter

- B** Removable lid
- C** Kettle body
- D** Power-on indicator light
- E** 360° base with cord storage
- F** Plug
- G** ON/OFF switch
- H** Water level indicator

USE

Before use

- Remove all packaging from the kettle and power base.
- Do not let children play with them to avoid suffocation hazard.
- Remove any labels from the outer stainless steel surfaces.
- Remove the filter (fig. 1) and wash with water (fig. 2). Refer to "Removing the scale filter".
- Fill the kettle to 'MAX' level and boil.
- The boiled water should be discarded and the kettle rinsed out with cold water. Repeat the boil and rinse steps for at least three times to remove any manufacturing dust, etc.
- After the kettle has been rinsed out, re-fit the filter (fig. 3).

In use

With the specially designed power base and central connector, you can now set the kettle on the base at any angle, from any position.

- Release cord from storage base and adjust length by winding around the base to give the correct cord length to reach the plug socket to be used (fig. 4).
- Do not let cord hang over edge of table or counter, or touch hot surfaces (for example the top **B**).

Filling

- Remove the kettle from the base unit before filling.
- Open lid and fill kettle to desired level.

Do not fill with less than 0.5 litres of water to prevent the kettle running dry while operating; misuse of this kind will shorten the life of the element. **Do not fill with more than 1.7 litres of water** (up to the MAX level). **If the kettle is overfilled, there is a risk that boiling water may be ejected causing burns.**

Switching on

- Plug the power base into the mains socket.
- Place kettle on power base.
- Press the ON/OFF switch down (fig. 5) to switch the kettle on.

- The pilot light will switch on.
- The kettle will automatically switch off once the water is boiled (the ON/OFF switch will click upwards and the lights will switch off).
- To turn the kettle off before the water boils, you may move the ON/OFF switch up to the OFF position, or simply lift the kettle from its base it will switch off and the switch will return to the OFF position automatically.

Pouring

- Remove the kettle from the power base and carefully pour out the water. Do not tilt the kettle suddenly or pour water out at too sharp an angle.
- When you lift the kettle from the base, you may see moisture on the top surface of the base. Condensation on the base is perfectly normal, and should not be a cause for alarm.

 **Please note:** Empty the kettle after each use. Rinse the kettle with fresh water if you have not used for more than two days. To reduce energy consumption and waste of water, use only the amount of water you need.

SAFETY DEVICES

1) Automatic ON/OFF switch:

Your kettle is fitted with an ON/OFF switch which automatically switches off once the water has boiled. If the kettle has just boiled, wait a minute or so before re-boiling the kettle. Do not attempt to hold the ON/OFF switch in the on position or adjust the switch mechanism.

2) Safety cut-out:

If the kettle is switched ON with too little or no water, it is protected against damage by a safety cut-out which will switch off the power. If this cut-out operates, disconnect the kettle from the mains supply and leave to cool down before refilling with cold water (otherwise the element could be damaged).

3) If kettle is lifted from base while operating (ON), it will automatically switch off.

MAINTENANCE

Cleaning the kettle

- Allow the kettle to cool down fully and disconnect the appliance from the mains before cleaning.
- Do not immerse the kettle or base in water.
- To maintain the precious finish of the appliance, we recommend cleaning the outside of the appliance with a damp cloth and water only.
- DO NOT use metal polish, flammable liquids or harsh

scouring agents.

- Ensure that all connectors and sockets are kept dry.

Scale

When the water is heated, the minerals in the water solidify, making the water appear cloudy. As soon as you notice a film forming on the water, or, when cleaning the filter, if you notice a film on the walls or the element, descale the kettle and its filter.

Scale filter

Your kettle is fitted with a scale filter to prevent loose particles of scale being poured into your beverage. This filter is both removable and washable. You should remove and clean the water filter when you notice any deposits being left on the filter or if the pouring efficiency is impaired.

Removing the scale filter

- Allow the kettle to cool down fully and disconnect the appliance from the mains electrical supply. Make sure that your hands are clean and free from soap, cream or anything which might taint the water.
- Empty the kettle and remove the filter as shown in fig. 1. Rinse under a tap whilst brushing with a soft brush (fig. 2) and replace the filter (fig. 3).

Filter may pose suffocation risk, do not let it unattended after cleaning.

To clean the kettle and the scale filter

It is vital to clean and descale regularly in order to maintain good working order. Excessive scale build-up may affect the performance of the product and shall be avoided.

- Use descaler for kettles (tip: use citric-acid based descaling solutions). When limescale starts forming on the heating element, buy a suitable descaler for kettles and descale according to the instructions given on the descaler pack.
- After descaling, boil repeatedly with fresh water and rinse thoroughly to completely eliminate all residues of descaler which could damage the appliance. Repeat the boil and rinse steps for at least three times.
- If the filter requires descaling, remove and immerse in the same descaling solution.
- Make sure electric parts are completely dry before using the kettle.

TECHNICAL CHARACTERISTICS

Supply voltage	See rating plate
Absorbed power	"