

Safety Information

Important Safety Information

SAVE THESE INSTRUCTIONS

⚠ WARNING: When using an electrical appliance, basic precautions should always be followed, including the following:

READ ALL INSTRUCTIONS

⚠ WARNING: To reduce the risk of injury or damage, read and follow the safety precautions when setting up, using and maintaining your robot.

This appliance can be used by children aged from 8 years and above and persons with reduced physical, sensory or mental capabilities or lack of experience and knowledge if they have been given supervision or instruction concerning use of the appliance in a safe way and understand the hazards involved. Children shall not play with the appliance. Cleaning and user maintenance shall not be made by children without supervision.

⚠ WARNING: Cancer and Reproductive Harm – www.P65Warnings.ca.gov/product

⚠ This is the safety alert symbol. It is used to alert you to potential physical injury hazards. Obey all safety messages that follow this symbol to avoid possible injury or death.

 Risk of electric shock

 Class II equipment

 Rated power output, d.c.

 Read operator's manual

 General symbol for recycling

 Risk of fire

 For indoor use only

 Rated power input, d.c.

 Keep out of reach of children

BFP Backfeed Protection

 Separate Supply Unit

 Indicates output polarity

 Rated power input, a.c.

WARNING: Indicates a hazardous situation that, if not avoided, could result in death or serious injury.

CAUTION: Indicates a hazardous situation that, if not avoided, could result in minor or moderate injury.

NOTICE: Indicates a hazardous situation that, if not avoided, could result in property damage.

GENERAL



WARNING

- Your robot is not a toy. Small children and pets should be supervised when your robot is operating.
- Do not sit or stand on your robot or Home Base charging station.
- Do not use unauthorized chargers. Use of an unauthorized charger could cause the battery to generate heat, smoke, catch fire, or explode.
- Your robot comes with a region approved power supply cord and is designed to be plugged into a standard household AC power outlet only. Do not use any other power supply cord. For replacement cords, please contact Customer Care to ensure proper selection of country specific power supply cord.
- Do not open your robot or the Home Base charging station. There are no user serviceable parts inside. Refer servicing to qualified service personnel.
- Risk of electric shock, use indoors in dry location only.
- Do not handle your robot and Home Base with wet hands.
- Store and operate your robot in room temperature environments only.
- If the room to be cleaned contains a balcony, a physical barrier should be used to prevent access to the balcony and ensure safe operation.



CAUTION

- Be aware that the robot moves on its own. Take care when walking in the area that the robot is operating in to avoid stepping on it.
- Do not operate the robot in areas with exposed electrical outlets in the floor.
- Do not use this device to pick up sharp objects, glass, or anything that is burning or smoking.
- If the device passes over a power cord and drags it, there is a chance an object could be pulled off a table or shelf. Before using this device, pick up objects like clothing, loose papers, pull cords for blinds or curtains, power cords, and any fragile objects.

NOTICE

- This robot is intended for dry floor use only. Do not use this device to pick up spills. Do not allow your robot or Home Base charging station to become wet.
- Do not place anything on top of your robot.
- The failure to maintain cleanliness of charger contacts could result in loss of ability for the robot to charge the battery.

HOME BASE® CHARGING STATION



WARNING

- Do not use a Home Base with a damaged cord or plug if the cord or plug is damaged, it must be replaced.
- Always disconnect your robot from the Home Base before cleaning or maintaining it.

- Only use the included battery charger to charge the iRobot ABL-D1 battery. Other type of batteries may burst causing injury. Always contact Customer Care for the correct replacement of your battery. Battery Charger model 17070: Input AC 100–240V, 50–60Hz, 0.68A; 33W. Output DC 20.5V, 1.25A.
- To prevent the risk of your robot falling downstairs, ensure that the Home Base Charging Station is placed at least 4 feet (1.2 meters) away from stairs.

NOTICE

- Product may not be used with any type of power converter. Use of power converters will immediately void the warranty.
- If you live in an area prone to electrical storms, it is recommended that you use additional surge protection. Your robot's Home Base may be protected with a surge protector in the event of severe electrical storms.



BATTERY

WARNING



- Do not open, crush, heat above 176°F: 80°C, or incinerate. Follow manufacturer's instructions.
- Do not short-circuit the battery by allowing metal objects to contact battery terminals or immerse in liquid. Do not subject batteries to mechanical shock.
- Periodically inspect the battery pack for any sign of damage or leakage. Do not charge damaged or leaking battery packs, do not allow the liquid to come in contact with skin or eyes. If contact has been made, wash the affected area with copious

amounts of water and seek medical advice. Place the battery in a sealed plastic bag and dispose of safely according to local environmental regulations. Return it to your local authorized iRobot Service Center for disposal.



CAUTION



- Battery usage by children should be supervised. Seek medical advice immediately if a cell or a battery has been swallowed.

NOTICE

- The battery pack must be removed from the robot before disposal.
- For best results, only use the iRobot Lithium Ion Battery that comes with the robot.
- Do not use non-rechargeable batteries. Use only the rechargeable battery supplied with the product. For replacement, purchase identical iRobot battery or contact iRobot Customer Care for alternative battery options.
- Batteries must be disposed of in accordance with local regulations.
- Always charge and remove the battery from your robot and accessories before long-term storage.

About your Roomba® Robot Vacuum

Top View

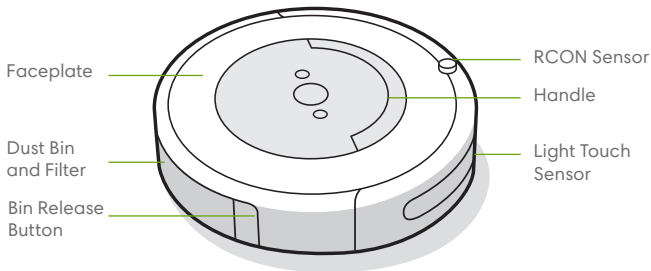

Home Base

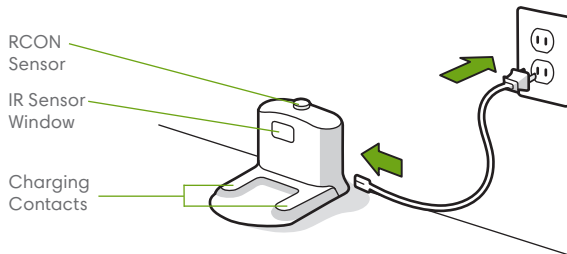

Bottom View

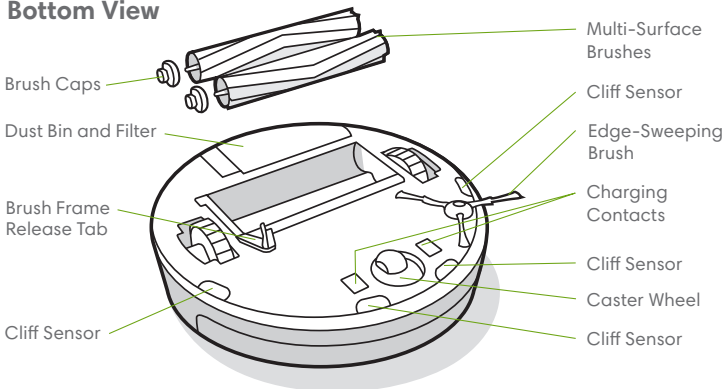

Buttons & Indicators

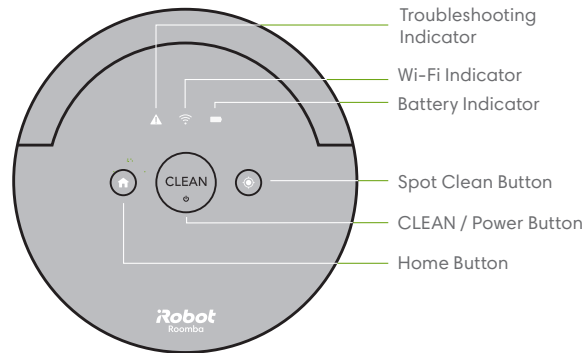

Using Your Roomba® Robot Vacuum

Place the Home Base® charging station

⚠ WARNING: To prevent the risk of your robot falling downstairs, ensure that the Home Base Charging Station is placed at least 4 feet (1.2 meters) away from stairs.

Place the Home Base in an open, uncluttered area leaving the following distances around the Home Base:

- At least 1.5 feet (0.5 meters) on each side of the Home Base
- At least 4 feet (1 meter) in front of the Home Base, and at least 4 feet (1 meter) away from stairs
- At least 8 feet (2.5 meters) from Virtual Wall Barriers
- Always keep the Home Base plugged in and make sure it is in an area with consistent Wi-Fi® coverage to allow the Roomba® robot vacuum to receive information via the iRobot HOME App.

Download the iRobot HOME App and connect to Wi-Fi®

- Watch an overview video with instructions on how to set-up and use your Roomba® robot vacuum
- Set an automatic cleaning schedule and customize cleaning preferences
- Enable automatic software updates
- Access to tips, tricks, and answers to commonly asked questions including how to pair your Roomba® robot vacuum with other smart devices.



Get to know your robot

- Place the robot on the Home Base to activate the battery

☰ Note: Your robot comes with a partial charge, but we recommend that you charge the robot on the Home Base for 3 hours prior to starting the first complete cleaning cycle.



☰ Note: Remove excess clutter from floors before cleaning (e.g. clothing, toys, etc.). Use your Roomba® robot vacuum frequently to maintain well-conditioned floors.

If the robot is returning to recharge after completing a cleaning cycle, it will play a series of tones to indicate successful completion of the job.

- To pause the robot during a cleaning cycle, press CLEAN.
- To resume the cleaning cycle, press CLEAN again.
- To send the robot back to its Home Base during a cleaning cycle, press CLEAN and then  (Home) button on the robot or press CLEAN on the iRobot HOME App main screen. This will end the cleaning cycle.

☰ Note: When the robot is returning to the Home Base, the  (Home) button will blink.

- The robot will automatically engage Dirt Detect™ mode when it encounters a high concentration of dirt or debris. The robot will move in a spiral motion to clean the area more thoroughly. The CLEAN button will pulse when the robot engages Dirt Detect™ mode. When finished, the robot will continue its cleaning job.

- You can use the Spot Clean feature to have the robot go after specific spills. Just place the robot in the center of the debris and press  (Spot Clean). The robot will clean the area by spiraling outward about 3 feet (1 meter) and then spiral inward to end where it started.
- Keep the robot on the Home Base[®] charging station so it's always ready to clean when you need it. If you need to store the robot off of the charging station, turn off the battery by removing the robot from the Home Base charging station and holding down the  (Home) button for 9 seconds, all indicators will turn off and you will hear an audible tone, then store the robot in a cool, dry place. To wake the robot up and turn on the battery, plug in the Home Base charging station and place the robot on the charging station.
- When the robot is charging, it will turn off the indicator lights to save energy. You can check the status by pressing the CLEAN button. The Battery Indicator icon will illuminate amber when the battery is charging, and green when the battery is fully charged. Battery charge status can also be viewed in the iRobot HOME App.

 **Note:** After each use, empty the bin and clean the filter.

Accessories

Dual Mode Virtual Wall[®] Barrier (compatible with all models)

Use the Dual Mode Virtual Wall[®] barrier to keep the robot in the places you want cleaned — and out of the ones you don't. It creates an invisible barrier that only the robot can see. You can leave the device in position between cleanings.

Choose the mode to meet your needs:

Virtual Wall Mode: When the switch is in the Virtual Wall position (,), the device will create a linear barrier to block openings up to 10 feet (3 meters).

 **Note:** This barrier gets wider as it gets further from the device (refer to illustration).

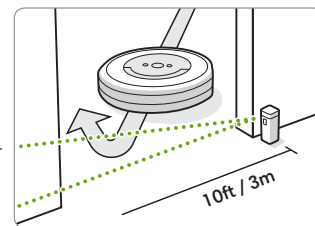
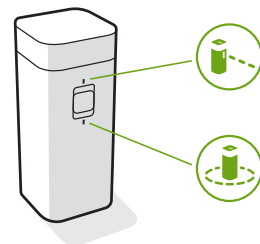

Halo Mode: Toggle the switch to the Halo position (,), to create a circular barrier. This will prevent the robot from approaching zones you want to protect such as a pet bowl, vase, or under a desk. The Halo barrier extends approximately 24 inches (60 centimeters) from the center of the device.

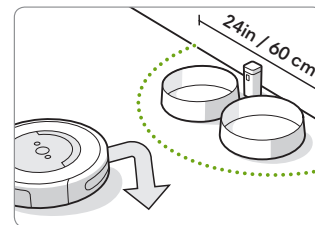

 **Note:** The batteries will last about 8-10 months under normal use. If you are not planning to use your Virtual Wall barrier for an extended period of time, be sure to turn the switch to the Off, or middle position.

Care and Maintenance

Care and Maintenance Instructions

To keep your Roomba® robot vacuum running at peak performance, perform the procedures on the following pages.

There are additional instructional videos in the iRobot HOME App. If you notice the robot picking up less debris from your floor, empty the bin, clean the filter and clean the brushes.

Care and Maintenance Overview

Part	Care	Replace*	Details
Bin	Empty after each use		Page 3
Filter	Clean every week (twice a week if you have a pet)	Every 2 months	Page 3
Front Caster Wheel	Clean every 2 weeks	Every 12 months	Page 4
Edge-Sweeping Brush and Multi-Surface Brushes	Clean every month (twice a month if you have a pet)	Every 12 months	Page 4-5
Sensors and Charging Contacts	Clean once a month		Page 5

 **Note:** iRobot manufactures various replacement parts and assemblies. If you think you need a replacement part, please contact iRobot Customer Care for more information. Ask Customer Care “Or visit an authorized iRobot® dealer.”

*Replacement frequency may vary. Parts should be replaced if visible wear appears.

Emptying the Bin

- 1 Press bin release button to remove bin.



- 2 Open bin door to empty bin.

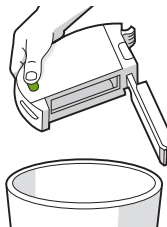

- 3 Place bin back in the robot.

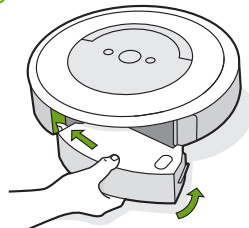

Cleaning the Filter

- 1 Release the bin. Remove the filter by grasping both ends and pulling out.

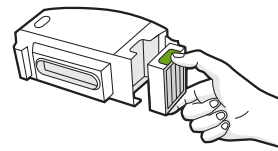

- 2 Shake off debris by tapping the filter against your trash container.



- 3 Reinsert filter with ridged grips facing out. Place bin back in the robot.

 **Important:** The robot will not run if the filter is not installed correctly. Replace the filter every two months.

Washing the Bin

*** Important:** Do not wash the filter. Remove the filter before washing the bin.

- 1 Release the bin, remove the filter, and open the bin door.
- 2 Rinse the bin using warm water.

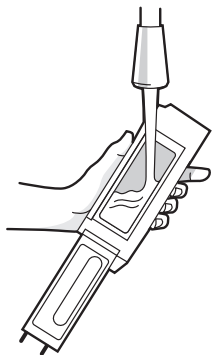

- 3 Make sure bin is completely dry. Reinsert filter and place bin back in the robot.

Note: Bin is not dishwasher safe.

Cleaning the Front Caster Wheel

- 1 Pull firmly on the front wheel to remove it.
- 2 Remove any debris from inside the wheel cavity.
- 3 Reinstall all parts when finished. Make sure the wheel clicks back into place.

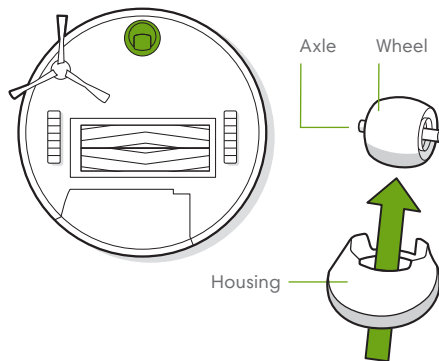

*** Important:** A front wheel clogged with hair and debris could result in damage to your floor. If the wheel is not spinning freely after you have cleaned it, please contact Customer Care.

Cleaning the Edge-Sweeping Brush

- 1 Use a coin or small screwdriver to remove the screw holding the Edge-Sweeping Brush in place.
- 2 Remove the Edge-Sweeping Brush, clean the brush and the brush post, and then reinstall the brush.

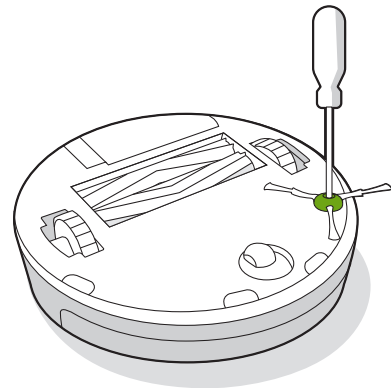

Cleaning the Multi-Surface Brushes

1 Pinch the brush frame release tab, lift the tab, and remove any obstructions.

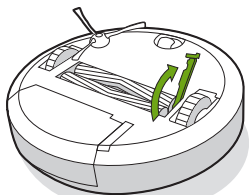

2 Remove the brushes from the robot. Remove the brush caps from the ends of the brushes. Remove any hair or debris that has collected beneath the caps. Reinstall the brush caps.

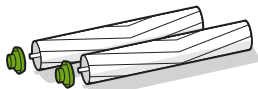

3 Remove any hair or debris from the square and hexagonal pegs on the opposite side of the brushes.

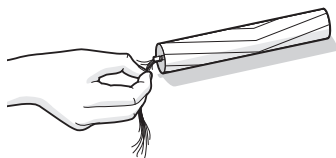

4 Remove the bin from the robot and clear any debris from the vacuum path.

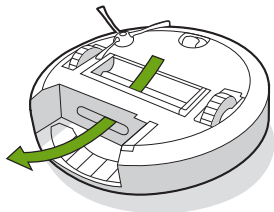

5 Reinstall the brushes in the robot. Match the shape of the brush pegs with the shape of the brush icons in the cleaning head module.

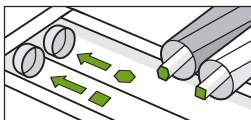

Cleaning the Sensors and Charging Contacts

1 Wipe sensors and charging contacts with a clean, dry cloth.

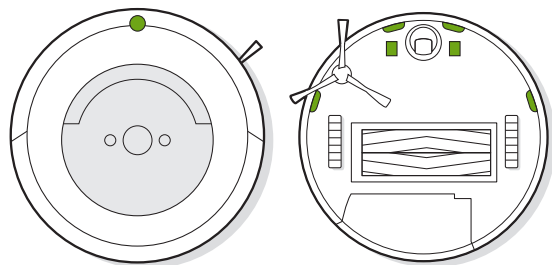

Important: Do not spray cleaning solution or water onto the sensors or sensor openings.



Troubleshooting

EN

Your Roomba® robot vacuum will tell you something is wrong with a two-tone alert, a spoken message and a blinking troubleshooting indicator (⚠️). Follow the audible instructions. More detailed support and videos, are available in the iRobot HOME App and at global.irobot.com.

To reboot your robot, press and hold the 🏠 (Home) and ⚡ (Spot Clean) buttons for 10 seconds until all indicators turn off, then release. When you release the buttons, you will hear a tone to confirm a successful reboot.

 **Note:** If you use the scheduling feature, open the iRobot HOME App after rebooting to confirm that the robot's schedule remains intact.

Reduced Power Standby Mode

The Roomba® robot vacuum uses a small amount of power whenever it is on the Home Base® charging station. This ensures the robot is always ready for the next cleaning job and maintains Wi-Fi® connectivity. You can put the robot in a further-reduced power state when not in use. For instructions and more details on this Reduced Power Standby Mode, refer to the iRobot HOME App.

Lithium Ion Battery

For best results, only use the iRobot Lithium Ion Battery that comes with your Roomba® robot vacuum.

 **WARNING:** Lithium ion batteries and products that contain lithium ion batteries are subject to stringent transportation regulations. If you need to ship this product (with the battery included) for service, travel or any other reason, you **MUST** follow the below shipping instructions.

- Battery **MUST** be turned off before shipping.
- Remove the robot from the Home Base Charging Station.
- Ensure that the CLEAN button is illuminated by pressing the CLEAN button once quickly.
- Once the button is illuminated, press and hold the CLEAN button for 12 seconds, you will hear an audible tone.
- Once you hear the tone, release the CLEAN button, the battery is now turned off.
- Package the product in its original packaging.
- Ship via ground transportation only (no air shipping).
- If you need further assistance, contact our Customer Care team.

M

iRobot Customer Care

USA & Canada

If you have questions or comments about your Roomba® robot vacuum, please contact iRobot before contacting a retailer.

You can start by visiting global.irobot.com for support tips, frequently asked questions and information about accessories. This information can also be found in the iRobot HOME App. If you need further assistance, call our Customer Care team at **(877) 855-8593**.

iRobot Customer Care Hours

- Monday to Friday, 9AM – 9PM Eastern Time
- Saturday and Sunday 9AM – 6PM Eastern Time

Outside USA & Canada

Visit global.irobot.com to:

- Learn more about iRobot in your country.
- Get hints and tips to improve your Roomba® robot vacuum's performance.
- Get answers to questions.
- Contact your local support center.

Regulatory Information

This device complies with part 15 of the FCC Rules. Operation is subject to the following two conditions: (1) This device may not cause harmful interference, and (2) this device must accept any interference received, including interference that may cause undesired operation. This device complies with Industry Canada license-exempt RSS standard(s). Operation is subject to the following two conditions: 1) This device may not cause interference, and 2) this device must accept any interference, including interference that may cause undesired operation of the device.

- Changes or modifications not expressly approved by iRobot Corporation could void the user's authority to operate the equipment.
- This equipment has been tested and found to comply with the limits for a Class B digital device, pursuant to part 15 of the FCC Rules as well as ICES-003 Rules. These limits are designed to provide reasonable protection against harmful interference in a residential installation. This equipment generates, uses and can radiate radio frequency energy and, if not installed and used in accordance with the instructions, may cause harmful interference to radio communications. However, there is no guarantee that interference to radio communication will not occur in a particular installation. If this equipment does cause harmful interference to radio or television reception, which can be determined by turning the equipment off and on, the user is encouraged to try to correct the interference by one or more of the following measures:

- Reorient or relocate the receiving antenna.
- Increase the separation between the equipment and receiver.
- Connect the equipment into an outlet on a circuit different from that to which the receiver is connected.
- Consult the dealer or an experienced radio/TV technician for help.
- Under Industry Canada regulations, this radio transmitter may only operate using an antenna of a type and maximum (or lesser) gain approved for the transmitter by Industry Canada. To reduce potential radio interference to other users, the antenna type and its gain should be so chosen that the equivalent isotropically radiated power (e.i.r.p.) is not more than the necessary for successful communication.
- FCC Radiation Exposure Statement: This product complies with FCC §2.1093(b) for portable RF exposure limits, set forth for an uncontrolled environment and is safe for the intended operation as described in this manual.
- ISED Radiation Exposure Statement: This product complies with the Canadian Standard RSS-102 for portable RF exposure limits, set forth for an uncontrolled environment and is safe for the intended operation as described in this manual.

For battery recycling go to call2recycle.org; or call 1-800-822-8837



iRobot

©2018 iRobot Corporation, 8 Crosby Drive, Bedford, MA 01730 USA. All rights reserved. iRobot, Roomba, iAdapt, Home Base and Virtual Wall are registered trademarks of iRobot Corporation. Dirt Detect is a trademark of iRobot Corporation. App Store is a trademark of Apple, Inc., registered in the U.S. and other countries. Google Play is a trademark of Google, Inc.

WC: 4624099

