



DRAPER[®]

STORMFORCE

MMA INVERTER WELDER

70041, 70042



These instructions accompanying the product are the original instructions. This document is part of the product, keep it for the life of the product passing it on to any subsequent holder of the product. Read all these instructions before assembling, operating or maintaining this product.

This manual has been compiled by Draper Tools describing the purpose for which the product has been designed, and contains all the necessary information to ensure its correct and safe use. By following all the general safety instructions contained in this manual, it will ensure both product and operator safety, together with longer life of the product itself.

All photographs and drawings in this manual are supplied by Draper Tools to help illustrate the operation of the product.

Whilst every effort has been made to ensure the accuracy of information contained in this manual, the Draper Tools policy of continuous improvement determines the right to make modifications without prior warning.

1. INTRODUCTION

1.1 SCOPE

This MMA welding machine is designed to weld ferrous metals such as steel and iron.

This product is intended for domestic and infrequent light trade use only.

Any application other than that it was intended for, is considered misuse.

This product is not a toy and must not be used by children or any person with reduced physical, sensory or mental capabilities or lack of experience and knowledge, or people unfamiliar with these instructions.

Local regulations may restrict the age of the operator.

1.2 UNDERSTANDING THIS MANUALS SAFETY CONTENT:

 **Warning!** – Information that draws attention to the risk of injury or death.

Caution! – Information that draws attention to the risk of damage to the product or surroundings.

1.3 EXPLANATION OF SYMBOLS



Warning!
Read the instruction manual.



Warning!
Wear suitable welding eye/face protection.



Warning!
Wear ear defenders (During grinding operations).



Warning!
Wear protective gloves.



Keep out of the reach of children.



Warning!



Danger of electric shock.



Danger of fire.



Danger of explosion.



Danger of fumes.



Danger of ultraviolet radiation.



Danger of burning splashes.



Fan cooled.



Input current.



Input voltage.



Protection rating.



Thermal overload.



MMA welding range.



Electrode size.



Machine weight.



WEEE –
Waste Electrical & Electronic Equipment.
Do not dispose of Waste Electrical & Electronic Equipment in with domestic rubbish.



For indoor use only.
Do not expose to rain.



Class 1 appliance
(Must be earthed).



UK Conformity Assessed.



European conformity.

2. SPECIFICATION

2.1 SPECIFICATION

Stock No. 70041
Part No. INV140A/SF
Rated voltage 230~50Hz
Input current 16A
Current range 20 – 140A
Electrode size 1.6 – 3.2mm
Dinse Type Socket 25/10
Degree of protection IP21S
Cooling Air (fan)
Insulation class F
Duty cycle: 35% @ 140A / 100% @ 90A
Weight (Gross/Net/machine only) 3.5/3.1/2.2kg

Stock No. 70042
Part No. INV120A/SF
Rated voltage 230~50Hz
Input current 16A
Current range 20 – 120A
Electrode size 1.6 – 3.2mm
Dinse Type Socket 25/10
Degree of protection IP21S
Cooling Air (fan)
Insulation class F
Duty cycle: 35% @ 120A / 100% @ 85A
Weight (Gross/Net/machine only) 3.4/3.0/2.1kg

3. HEALTH AND SAFETY INFORMATION

3.1 GENERAL SAFETY INSTRUCTIONS

 **Warning! Read all safety warnings and all instructions.** When using electric tools basic safety precautions should always be followed to reduce the risk of fire, electric shock, and personal injury including the following.

Read all these instructions before attempting to operate this product and save these instructions.

Electric shock can kill:

- Remove the plug from the socket before carrying out adjustment, servicing, or maintenance.
- Allow 5 minutes waiting time for the capacitors to discharge before removing the panels for any maintenance operations
- Do not touch live electrical parts.

- Never use electrode holders or cables with damaged or deteriorated insulation.
- Keep the working environment, equipment, cables, and clothing free from grease, oil, moisture, and dirt.
- Ensure the welding machine has been correctly earthed and all panels are fitted securely.
- The operator must be insulated from the floor and workbench using a dry insulation mat.
- Wear isolating footwear and gloves that are in good condition, i.e. without holes.
- In hazardous conditions of increased electric shock always ensure a second person is present in case of an accident.
- Never change electrodes with bare hands or damp gloves (for ARC/MMA welders).
- Keep welding cables away from power cables.
- Regularly inspect the condition of the welding, earth, and power cables for signs of damage.
- Do not leave the machine unattended and remove the plug from the socket when not in use.
- Do not use welding cables unsuitable for the amperage.
- Ensure the earth clamp is adjacent to the weld seam, secured to bare metal and when not in use is insulated for safety.
- Keep all equipment well maintained.
- The operator shall prevent gas cylinders in the vicinity of the workpiece from becoming part of the welding circuit.

Fumes & Gases can be harmful:

- The welding process generates hazardous fumes as a by-product. Inhalation of these fumes is hazardous to health.
- Keep your head away from the weld to avoid breathing the fumes.
- If welding in confined spaces ensure adequate ventilation and use a fume extractor.
- Welding fumes displace oxygen. The danger of suffocation.
- By-products of welding can react with other chemical vapours to produce a toxic/explosive environment.

Welding can cause fire or explosion:

- Arc welding and allied processes can cause fire and explosions and precautions shall be taken to prevent these hazards.
- Before starting a weld ensure the area is clear of flammable materials.
- Remove any inflammables to a safe distance, especially substances likely to generate a dangerous vapour.
- The welding arc can cause serious burns. Avoid contact with skin.

- Sparks and molten metal are cast out during welding. Take precautions to prevent fire igniting and wear protective clothing.
- Sparks and molten metal can pass through gaps. Be aware that fire can start out of sight. Flammables in a locked cabinet may not be safe.
- Do not weld pressurised containers.
- Do not weld tanks, drums, or other vessels until they have been correctly cleaned/prepared for welding.
- Always have appropriate and fully maintained fire-fighting equipment suitable for the materials used and for use in electrical environments available in close proximity at all times.
- Keep clothing free from oil and grease.
- Wear a hat, flame-proof apron, woollen clothing, gloves, long sleeve tops with closed neck, trousers (without turn-ups) to cover non-slip boots.
- Protective head and shoulder coverings should be worn when overhead welding.
- Avoid taking any fuels with you e.g. cigarette lighters or matches.
- Hot spots and their immediate surroundings should be observed until their temperature has dropped to normal.

Personal Protection:

- The body should be protected by suitable clothing.
- The use of neck protection may be necessary against reflected radiation.
- Wear safety glasses when chipping, wire brushing, grinding, or when near cooling welds as metal filings or slag can be thrown up. Fully enclosed goggles are advisable.
- Arc machines generate a magnetic field which is detrimental to pacemaker recipients. Consult your doctor before going near welding equipment/operations.
- The UV and IR radiation generated by welding is highly damaging to the eye, causing burns. This can also affect the skin. Protect the eyes and face.
- The face and eyes shall be protected by suitable welding shields equipped with appropriate ocular protection filters.
- Where environments are subject to pedestrians and traffic ensure a protective screen is used to avoid accidental arc glare.
- Do not weld in the vicinity of children or animals and ensure no one is looking before striking up.
- In the welding environment, damaging levels of noise can exist. Wear hearing protection if the process dictates.
- Do not touch hot equipment or metal. Allow the weld time to cool, use the correct tool and wear protective welding gauntlets.
- Wear flame retardant clothing (leather, wool, etc.).

- Take care when adjusting or maintaining the torch that it has had time to cool sufficiently and is disconnected.
- The arc generates
 - ultra-violet radiation (can damage skin and eyes).
 - visible light (can dazzle eyes and impair vision).
 - infra-red (heat) radiation (can damage skin and eyes).
- Such radiation can be direct or reflected from surfaces such as bright metals and light coloured objects.

Gas cylinders:

- Gas cylinders should be located or secured so that they cannot be knocked over.
- Shield gas containers can explode if damaged. Take care when handling.
- Ensure gas cylinders are shut-off when not in use and between operations.
- Take care that no build-up of gas is permitted to form in confined areas.
- Cylinders must be in an upright position at all times during use and storage.
- The gas cylinder must never come in contact with the electrode.
- Follow the manufacturer's instructions for handling, storing, and using the gas bottle correctly and safely.
- Use the correct equipment to connect the gas bottle to the welding torch.

Limitations:

- Do not use for:
 - operations in severe conditions (e.g. extreme climates, freezer applications, strong magnetic fields, etc).
 - operations subject to special rules (e.g. potentially explosive atmospheres, mines, etc).
 - operations that require ingress protection greater than IPX0, e.g. in rain or snow, etc.

General:

- Training should be sought out in
 - the safe use of this equipment;
 - the processes;
 - the emergency procedures;
- Welding power sources are not to be used for pipe thawing.
- Take precautions against toppling over, if the power source shall be placed on a tilted plane.
- All equipment should be kept in good working condition, inspected and, when defective, promptly repaired or withdrawn from service - All equipment should be placed so that it does not present a hazard in passageways, on ladders, or stairways, and should be operated in accordance with the manufacturer's instructions.

- In the vicinity of an arc, non-reflective curtains or screens shall be used to isolate persons from the arc radiation. A warning, e.g. a symbol for eye protection, should refer to the hazard of arc radiation.

4. UNPACKING AND CHECKING

4.1 PACKAGING

Carefully remove the product from the packaging and examine it for any sign of damage. Check contents against the parts shown in Fig A. If any part is damaged

or missing, please contact the Draper Help Line (see back page). Do not attempt to use the product!

The packaging material should be retained during the warranty period, in case the product needs to be returned for repair.

Warning!

- Some of the packaging materials may be harmful to children. Do not leave any of these materials in reach of children.
- If any of the packaging is to be thrown away, make sure they are disposed of correctly, according to local regulations.

5. TECHNICAL DESCRIPTION

5.1 PRODUCT IDENTIFICATION – FIG.A



70041 shown.

- | | |
|---|---|
| <ul style="list-style-type: none"> (1) Current adjustment control. (2) Thermal overload LED indicator. (3) LED amperage display. (4) Carry handle. (5) MMA earth clamp. (6) MMA welding electrode holder. | <ul style="list-style-type: none"> (7) MMA electrode holder connection. (8) MMA earth clamp connection. (9) ON/OFF Switch. (10) Power supply cable. (11) Face mask. (12) Brush. |
|---|---|

FIG.A

Note: For details of our full range of accessories and consumables, please visit drapertools.com

6. ASSEMBLING THE MMA WELDER

6.1 CONNECTION TO THE POWER SUPPLY

Make sure the power supply information on the product's rating plate is compatible with the power supply you intend to connect it to.

A suitable plug must be fitted by a qualified electrician.

This product's wiring has insulation stripped in preparation for wiring a 16A plug (not supplied).

It is designed for connection to a 16 amp power supply rated at 230V AC.

Because it is constructed mostly of metal parts, it is a Class 1 machine; meaning, it must have an earth connection in the power supply. This is to prevent electrocution in the event of a failure.

Note: Remove the plug from the socket before carrying out adjustment, servicing or maintenance.

Check that the electrical supply delivers the voltage and frequency corresponding to the product and that it is fitted with a delayed fuse suited to the maximum delivered rated current.

Note: This product has been set to the highest voltage at the factory.

6.2 CONNECTING THE EARTH CLAMP – FIG.1

- With the lug on the pin at top, push the connector (5.1) fully into the right-hand (–) port (8) then turned clockwise 180° to lock, hand tight only.

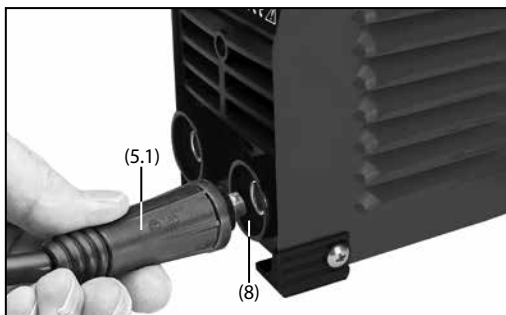

FIG. 1

6.3 ATTACHING THE ELECTRODE HOLDER

- The electrode holder (6) is connected into the left hand (+) (7) port unit in the same way as the earth clamp.

7. SETTING THE MMA WELDER

7.1 RATING PLATE

GRABER SYDAM/FORCE		Stock No.70041 DTL S053 1YF, UK.	Serial No.:	
1~ f_1 f_2 ---		IEN 60974-1:2005		
U	I	20A/21.2V – 140A/25.6V		
	$U_0=62V$	X	35%	100%
	U_2	I_2	140A	90A
	U_2	U_2	25.6V	23.6V
	$U_1=230V$	$I_{1MAX}=20.8A$	$I_{1eff}=13.6A$	
1-50/60Hz				
IP21S			Class F	

IP21S Unit's protection class rating.



MMA welder.



Semiconductor diode rectifier.†



Power supply identifier, e.g. socket with 3 poles.
1-50/60Hz



Direct Current (DC) delivery.†



Inverter frequency conversion stage.†



Transformer.†



Fan cooled.



Indoor use only. Do not expose to rain.

Class F Insulation rating.

† Symbols can be combined, for example:



Single Phase D.C MMA Welder.



Constant current.



Do not dispose of WEEE* as unsorted municipal waste.



UK Conformity Assessed.



European conformity.

$U_0=62V$

Secondary no-load voltage.

$U_1=230V$

Rated supply voltage.

X

Rated duty cycle.

I_2

Welding current (AMPS)

U_2

Welding current (VOLTS)

$I_{1MAX}=20.8A$

Unit's maximum absorbed current (AMPS).

$I_{1eff}=13.6A$

Unit's effective absorbed current (AMPS).

IEN 60974-1:2005

European reference safety standard.

* Waste Electrical & Electronic Equipment

7.2 MMA/ARC WELDING FILLER ROD (ELECTRODE) SELECTION – FIG.2

The correct selection of electrode size and type will vary for each application dependent upon material thickness, material type, amperage and equipment, however as a guide the figures below provide an indication.

MMA Electrode	Material Thickness	Amp Range
≤1.6mm	1-1.5mm	≤50A
2.0mm	1.2-3mm	45 - 75A
2.5mm	2-5mm	75 - 110A
3.25mm	4-8mm	100 - 150A

FIG. 2

8. OPERATION

8.1 BASIC MMA/ARC WELDING PROCESS OVERVIEW – FIG.3

During the MMA welding process, the arc created between the work piece and the consumable electrode rod melts the parent metal and the filler metal in a weld pool.

The electrode's flux coating reacts during this process and develops into a shield gas protecting the weld bead. Part of this reaction leaves a trail of slag which solidifies behind the weld pool protecting the weld as it cools.

The most common varieties of electrodes are cellulosic, rutile and basic, the latter two being the most general purpose.

Selection of the appropriate specification electrode is important to achieve a good quality weld. Seek guidance if unsure of selection.

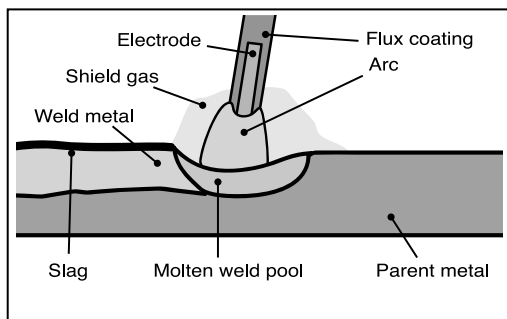

FIG. 3

8.2 MMA/ARC MACHINE OPERATION – FIG.4

- Prepare the joint(s) to be welded.
- Insert the electrode suitable for the application into the electrode holder (6) while pressing lever (6.1).

- With the earth clamp and electrode holder connected, connect the machine to the power supply. The power display will illuminate as confirmation. Set the amperage appropriate to the selected electrode size.
- Secure the earth clamp to a clean sound section of the parent metal in the vicinity to the intended weld.
- With all safety equipment in place and personal protective clothing on begin welding.
- Lower the electrode down toward the parent metal and strike the arc.
- The position of the electrode is critical to the arc and the end result.
- Achieving a good weld will take practice. For more detailed information refer to a industry standard welding publication and/or seek training on the subject.
- Use of an anti-spatter spray – Draper stock No.05709 – will help to achieve a cleaner finished weld.

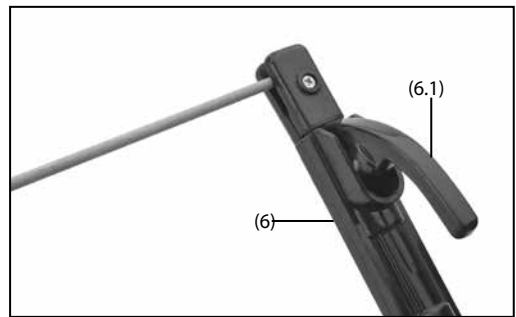

FIG. 4

8.3 DIRECTION OF WELD – FIG.5

- Strike the initial arc perpendicular to the parent metal before moving the electrode holder in the direction of travel 20-30° (Z, Y axis) and tilt it 20-30° (Z, X axis).
- Maintain a constant gap between the electrode tip and the weld pool of approximately 1 – 1.5 x the diameter of the electrode for a stable arc.

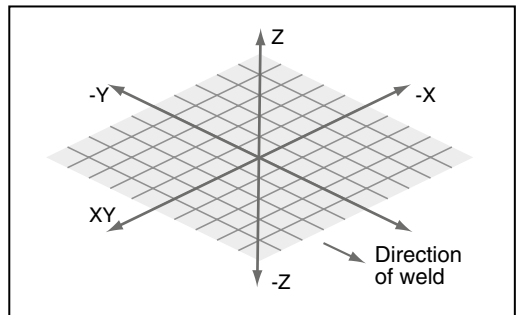

FIG. 5

8.4 'HOT START' FEATURE

The machine is equipped with a 'Hot Start' feature.

- A peak of current is delivered when striking the arc. This gives easy starting the electrodes, especially when faced with challenging operating conditions, ie; damp, or 'difficult to run' electrodes or an imperfect workpiece.

8.5 'ANTI-STICK' FEATURE

The machine is equipped with an 'Anti-Stick' feature, which ensures smooth welding and reduces instances of the electrode becoming stuck to the parent metal.



- The machine will automatically reduce the intensity of the current in order to aid quick and simple separation of the electrode and parent metal.

8.6 DUTY CYCLE



Duty Cycle is a percentage of 10 mins, in which a machine can operate at a rated load without overheating and interruption from the thermal cut-out device.

Example: **150A @ 30% Duty factor**

  150A welding for 3 minutes

  7 minutes down time

Example: **95A @ 100% Duty factor**

  95A continuous welding

To increase the operation time, reduce the amperage.

Note: The heating tests have been carried out at ambient temperature and the duty cycle (duty factor) at 20°C has been determined by simulation.

8.7 THERMAL CUT-OUT – FIG.6

If welding for extended periods, the thermal cut-out will activate and the LED indicator (2) will illuminate, prohibiting use of the machine until sufficiently cool.

Caution! After completion of any welding task, leave the unit connected to the power supply for a sufficient period to allow the cooling fan to continue working.



FIG. 6

9. MAINTENANCE AND TROUBLESHOOTING

9.1 TROUBLESHOOTING GUIDE

WARNING: For your own safety, turn the switch off and remove the plug from the power supply socket.

Problem	Possible cause	Required action
No spark.	Bad clamp connection.	Check clamp connection.
	PCB on the inverter is defective or damaged.	Contact Draper Tools/authorised service agent for repair/replacement.
No output voltage.	Overheated unit – the thermal cut-out LED will be illuminated.	Wait for unit to cool and the re-setting of the thermal cutout.
	Failure of internal relay.	Contact Draper Tools/authorised service agent for repair/replacement.
	PCB on the inverter is defective or damaged.	Contact Draper Tools/authorised service agent for repair/replacement.

Incorrect current output.	Current control selector is defective.	Contact Draper Tools/authorised service agent for repair/replacement.
	Supply voltage is low power.	Check the mains power distribution.
Porous welded joint.	Acid electrode on steel with high sulphur content.	Use a basic electrode.
	Workpieces are too far apart.	Move welded edges closer together.
	Workpiece is too cold.	Move slowly at beginning of weld.
Cracks in weld.	Material is contaminated with dirt, oil, rust.	Clean workpiece before welding commences (essential for neat beads).
	Insufficient current.	Enable sufficient current.
Limited penetration.	Low current.	Make the appropriate corrections.
	High welding rate.	
	Reversed polarity.	
	Electrode non-aligned to position of movement.	
High sprays.	Electrode is too inclined.	Make the appropriate corrections.
Welding profile defects.	Welding parameters are incorrect.	Follow rudimentary welding processes and procedures.
	Pass rate is not related to operating parameter requirements.	
	Electrode not inclined during welding session.	
Unstable arc.	Insufficient current.	Check earth connection and electrode conditions.

 **Warning!** Please note, all repairs/service should be carried out by a qualified person.

9.2 MAINTENANCE

Regular inspection and cleaning reduces the necessity for maintenance operations and will keep your tool in good working condition.

 **Warning!** Remove the plug from the power supply. Periodically the welder must be checked as detailed below.

- Check the electrode and earth cable connections.
- Clean the outside of the welder with a damp cloth.
- Occasionally test to ensure the thermal cut-out device is operating correctly, i.e. weld for an extended period or on a maximum duty cycle.
- Check the condition of the warning labels.
- Replace any worn parts.
- If the replacement of the supply cord is necessary, this has to be done by Draper Tools or an authorised service agent to avoid a safety hazard.

The welder must be correctly ventilated during tool operation. Avoid blocking the air inlets and vacuum the ventilation slots regularly.

Do not use solvents or fuels to clean the product. When not in use, store the product in a safe, dry place.

10. WARRANTY

10.1 WARRANTY

Draper tools have been carefully tested and inspected before shipment and are guaranteed to be free from defective materials and workmanship.

Should the tool develop a fault, please return the complete tool to your nearest distributor or contact:

Draper Tools Limited, Chandler's Ford, Eastleigh, Hampshire, SO53 1YF. England.

Telephone Sales Desk: +44 (0)23 8049 4333 or:

Product Helpline +44 (0)23 8049 4344.

A proof of purchase must be provided.

If upon inspection it is found that the fault occurring is due to defective materials or workmanship, repairs will be carried out free of charge. This warranty period covering labour is 12 months from the date of purchase except where tools are hired out when the warranty period is 90 days from the date of purchase. This warranty does not apply to any consumable parts, any type of battery or normal wear and tear, nor does it cover any damage caused by misuse, careless or unsafe handling, alterations, accidents, or repairs attempted or made by any personnel other than the authorised Draper warranty repair agent.

Note: If the tool is found not to be within the terms of warranty, repairs and carriage charges will be quoted and made accordingly.

This warranty applies in lieu of any other warranty expressed or implied and variations of its terms are not authorised.

Your Draper warranty is not effective unless you can produce upon request a dated receipt or invoice to verify your proof of purchase within the warranty period.

Please note that this warranty is an additional benefit and does not affect your statutory rights.

Draper Tools Limited.

11. DISPOSAL

11.1 DISPOSAL

- At the end of the machine's working life, or when it can no longer be repaired, ensure that it is disposed of according to national regulations.
- Contact your local authority for details of collection schemes in your area.

In all circumstances:

- Do not dispose of power tools with domestic waste.
- Do not incinerate.
- Do not dispose of WEEE* as unsorted municipal waste.



* *Waste Electrical & Electronic Equipment.*

