

EN

# gorenje

BM201AG1X-740247

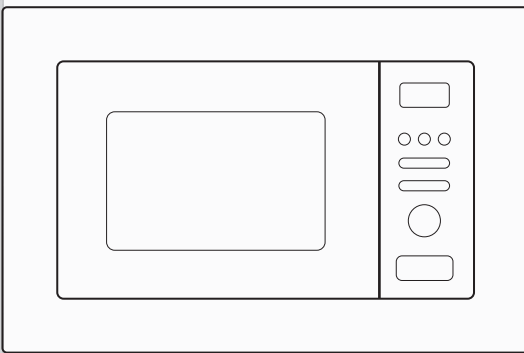

[www.gorenje.com](http://www.gorenje.com)

# MICROWAVE OVEN

## DEAR CUSTOMER

We sincerely thank you for your purchase. We believe you will soon find ample evidence that you can really rely on our products. To make the use of the appliance easier, we attach these comprehensive instruction manual.

The instructions should aid you in getting familiar with your new appliance. Please, read them carefully before using the appliance for the first time.

In any case, please make sure the appliance was supplied to you undamaged. Should you identify and transport damage, contact your sales representative or the regional warehouse from where the product was delivered. You will find the telephone number on the receipt or delivery report.



We wish you a lot of pleasure with your new household appliance.

The appliance for household use for heating food and beverages using electromagnetic energy, for indoor use only.

## INSTRUCTIONS FOR USE

Carefully read the instructions and save them for future reference.

These instructions are intended for the user. They describe the cooker and how to use it. They also apply to different types of appliances, therefore you may find some descriptions of functions that may not apply to your appliance.

## PRECAUTIONS TO AVOID POSSIBLE EXPOSURE TO EXCESSIVE MICROWAVE ENERGY

1. Do not attempt to operate this oven with the door open since this can result in harmful exposure to microwave energy. It is important not to break or tamper with the safety interlocks.
2. Do not place any object between the oven front face and the door or allow soil or cleaner residue to accumulate on sealing surfaces.
3. **WARNING:** If the door or door seals are damaged, the oven must not be operated until it has been repaired by a competent person.

### ADDENDUM

If the apparatus is not maintained in a good state of cleanliness, its surface could be degraded and affect the lifespan of the apparatus and lead to a dangerous situation.

## IMPORTANT SAFETY INSTRUCTIONS

### WARNING

To reduce the risk of fire, electric shock, injury to persons or exposure to excessive microwave oven energy when using your appliance, follow basic precautions, including the following:

- Read and follow the specific: " PRECAUTIONS TO AVOID POSSIBLE EXPOSURE TO EXCESSIVE MICROWAVE ENERGY".
- This appliance can be used by children aged from 8 years and above and persons with reduced physical, sensory or mental capabilities or lack of experience and knowledge if they have been given supervision or instruction concerning use of the appliance in a safe way and understand the hazards involved. Children shall not play with the appliance. Cleaning and user maintenance shall not be made by children without supervision.
- Keep the appliance and its cord out of reach of children less than 8 years.
- If the supply cord is damaged, it must be replaced by the manufacturer, its service agent or similarly qualified persons in order to avoid a hazard.
- **WARNING:** Ensure that the appliance is switched off before replacing the lamp to avoid the possibility of electric shock.
- **WARNING:** It is hazardous for anyone other than a competent person to carry out any service or repair operation that involves the removal of a cover which gives protection against exposure to microwave energy.

- **WARNING:** Liquids and other foods must not be heated in sealed containers since they are liable to explode.
- When heating food in plastic or paper containers, keep an eye on the oven due to the possibility of ignition.
- Only use utensils that are suitable for use in microwave ovens.
- If smoke is emitted, switch off or unplug the appliance and keep the door closed in order to stifle any flames.
- Microwave heating of beverages can result in delayed eruptive boiling, therefore care must be taken when handling the container.
- The contents of feeding bottles and baby food jars shall be stirred or shaken and the temperature checked before consumption, in order to avoid burns.
- Eggs in their shell and whole hard-boiled eggs should not be heated in microwave ovens since they may explode, even after microwave heating has ended.
- The oven should be cleaned regularly and any food deposits removed.
- Failure to maintain the oven in a clean condition could lead to deterioration of the surface that could adversely affect the life of the appliance and possibly result in a hazardous situation.
- Only use the temperature probe recommended for

this oven. (for ovens provided with a facility to use a temperature-sensing probe.)

- The microwave oven must be operated with the decorative door open. (for ovens with a decorative door.)
- This appliance is intended to be used in household and similar applications such as:
  - staff kitchen areas in shops, offices and other working environments;
  - by clients in hotels, motels and other residential type environments;
  - farm houses;
  - bed and breakfast type environments.
- The microwave oven is intended for heating food and beverages. Drying of food or clothing and heating of warming pads, slippers, sponges, damp cloth and similar may lead to risk of injury, ignition or fire.
- Metallic containers for food and beverages are not allowed during microwave cooking.
- The appliance shall not be cleaned with a steam cleaner.
- The appliance must not be installed behind a decorative door in order to avoid overheating. (This is not applicable for appliances with decorative door.)
- The microwave oven is intended to be used built-in.
- Care should be taken not to displace the turntable when removing containers from the appliance. (For fixed appliances and built-in appliances being used equal or higher than 900mm above the floor

and having detachable turntables. But this is not applicable for appliances with horizontal bottom hinged door.)

- Steam cleaner is not to be used.
- Surface of a storage drawer can get hot.
- Do not use harsh abrasive cleaners or sharp metal scrapers to clean the oven door glass since they can scratch the surface, which may result in shattering of the glass.
- **WARNING:** The appliance and its accessible parts become hot during use. Care should be taken to avoid touching heating elements. Children less than 8 years of age shall be kept away unless continuously supervised.
- During use the appliance becomes hot. Care should be taken to avoid touching heating elements inside the oven.
- **WARNING:** Accessible parts may become hot during use. Young children should be kept away.
- **WARNING:** When the appliance is operated in the combination mode, children should only use the oven under adult supervision due to the temperatures generated.

**READ CAREFULLY AND KEEP FOR FUTURE REFERENCE**

## TO REDUCE THE RISK OF INJURY TO PERSONS GROUNDING INSTALLATION

### **DANGER**

Electric Shock Hazard

Touching some of the internal components can cause serious personal injury or death. Do not disassemble this appliance.

### **WARNING**

Electric Shock Hazard

Improper use of the grounding can result in electric shock. Do not plug into an outlet until appliance is properly installed and grounded.

This appliance must be grounded. In the event of an electrical short circuit, grounding reduces the risk of electric shock by providing an escape wire for the electric current.

This appliance is equipped with a cord having a grounding wire with a grounding plug. The plug must be plugged into an outlet that is properly installed and grounded.

Consult a qualified electrician or serviceman if the grounding instructions are not completely understood or if doubt exists as to whether the appliance is properly grounded.

If it is necessary to use an extension cord, use only a 3-wire extension cord.

1. A short power-supply cord is provided to reduce the risks resulting from becoming entangled in or tripping over a longer cord.

2. If a long cord set or extension cord is used:
  - 1). The marked electrical rating of the cord set or extension cord should be at least as great as the electrical rating of the appliance.
  - 2). The extension cord must be a grounding-type 3-wire cord.
  - 3). The long cord should be arranged so that it will not drape over the counter top or tabletop where it can be pulled on by children or tripped over unintentionally.

## CLEANING

Be sure to unplug the appliance from the power supply.

- Clean the cavity of the oven after using with a slightly damp cloth.
- Clean the accessories in the usual way in soapy water.
- The door frame and seal and neighbouring parts must be cleaned carefully with a damp cloth when they are dirty.
- Do not use harsh abrasive cleaners or sharp metal scrapers to clean the oven door glass since they can scratch the surface, which may result in shattering of the glass.
- Cleaning Tip---For easier cleaning of the cavity walls that the food cooked can touch: Place half a lemon in a bowl, add 300ml (1/2 pint) water and heat on 100% microwave power for 10 minutes. Wipe the oven clean using a soft, dry cloth.

### **CAUTION**

#### **Personal Injury Hazard**

It is hazardous for anyone other than a competent person to carry out any service or repair operation that involves the removal of a cover which gives protection against exposure to microwave energy.

See the instructions on "Materials you can use in microwave oven or to be avoided in microwave oven." There may be certain non-metallic utensils that are not safe to use for microwaving. If in doubt, you can test the utensil in question following the procedure below.

#### **Utensil Test:**

- Fill a microwave-safe container with 1 cup of cold water (250ml) along with the utensil in question.
- Cook on maximum power for 1 minute.
- Carefully feel the utensil. If the empty utensil is warm, do not use it for microwave cooking.
- Do not exceed 1 minute cooking time.

## Materials you can use in microwave oven

Utensils	Remarks
Browning dish	Follow manufacturer's instructions. The bottom of browning dish must be at least 3/16 inch (5mm) above the turntable. Incorrect usage may cause the turntable to break.
Dinnerware	Microwave-safe only. Follow manufacturer's instructions. Do not use cracked or chipped dishes.
Glass jars	Always remove lid. Use only to heat food until just warm. Most glass jars are not heat resistant and may break.
Glassware	Heat-resistant oven glassware only. Make sure there is no metallic trim. Do not use cracked or chipped dishes.
Oven cooking bags	Follow manufacturer's instructions. Do not close with metal tie. Make slits to allow steam to escape.
Paper plates and cups	Use for short-term cooking/warming only. Do not leave oven unattended while cooking.
Paper towels	Use to cover food for reheating and absorbing fat. Use with supervision for a short-term cooking only.
Parchment paper	Use as a cover to prevent splattering or a wrap for steaming.
Plastic	Microwave-safe only. Follow the manufacturer's instructions. Should be labeled "Microwave Safe". Some plastic containers soften, as the food inside gets hot. "Boiling bags" and tightly closed plastic bags should be slit, pierced or vented as directed by package.
Plastic wrap	Microwave-safe only. Use to cover food during cooking to retain moisture. Do not allow plastic wrap to touch food.
Thermometers	Microwave-safe only ( meat and candy thermometers).
Wax paper	Use as a cover to prevent splattering and retain moisture.

## Materials to be avoided in microwave oven

Utensils	Remarks
Aluminum tray	May cause arcing. Transfer food into microwave-safe dish.
Food carton with metal handle	May cause arcing. Transfer food into microwave-safe dish.
Metal or metal-trimmed utensils	Metal shields the food from microwave energy. Metal trim may cause arcing.
Metal twist ties	May cause arcing and could cause a fire in the oven.
Paper bags	May cause a fire in the oven.
Plastic foam	Plastic foam may melt or contaminate the liquid inside when exposed to high temperature.
Wood	Wood will dry out when used in the microwave oven and may split or crack.

# Names of Oven Parts and Accessories

Remove the oven and all materials from the carton and oven cavity.

Your oven comes with the following accessories:



Glass Tray



Turntable Ring Assembly



Instruction Manual



Turntable Shaft

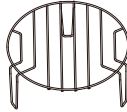

Grill Rack( Can not be used in microwave function and must be placed on the glass tray )

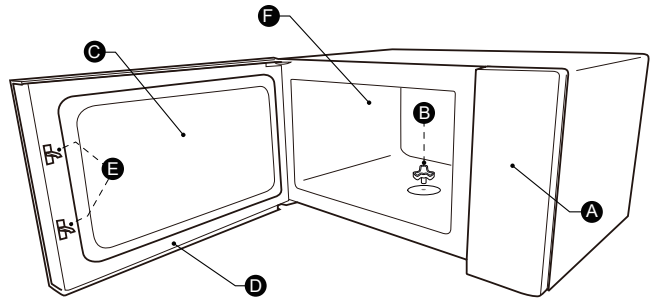

A)Control panel

D)Door assembly

B)Turntable shaft

E)Safety interlock system

C)Observation window

F)Oven cavity

## TURNTABLE INSTALLATION

Cleaning the cooking compartment and putting the turntable in place. For new installations, make sure all packaging and shipping tape has been removed from the turntable shaft. Before using the appliance to prepare food for the first time, you will need to put the turntable in place correctly. You must clean the cooking compartment and accessories.

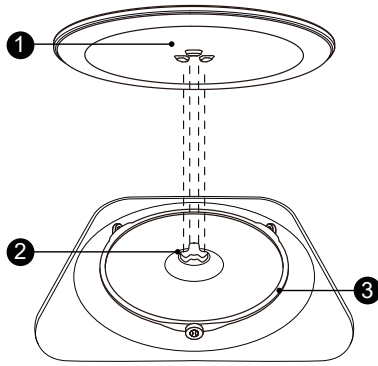

How to put the turntable in place:

1. Place the turntable ring assembly ③ into the recess in the cooking compartment.
2. Place the glass tray ① on the turntable ring assembly ③. Fit the raised, curved lines in the center of the glass tray bottom between the three spokes of the shaft. Make sure that the glass tray ① engages in the turntable shaft ② in the centre of the cooking compartment floor. The rollers on the shaft should fit inside the turntable bottom ridge.

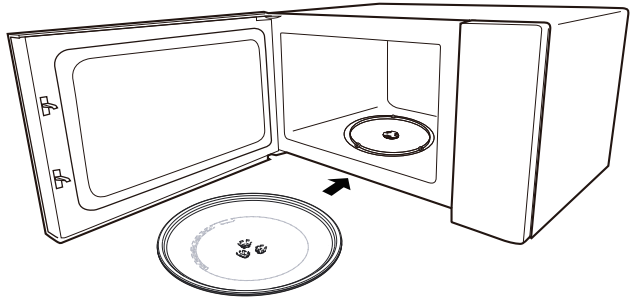







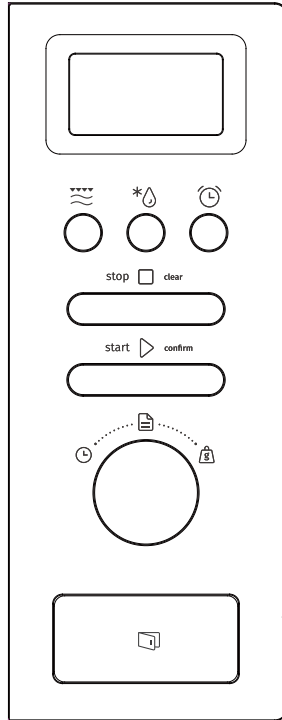

**Note:**

1. Never use the appliance without the turntable. Make sure that it is properly engaged. The turntable can turn clockwise or anti-clockwise.
2. Never place the glass tray upside down. The glass tray should never be restricted.
3. Both glass tray and turntable ring assembly must always be used during cooking.
4. All food and containers of food are always placed on the glass tray for cooking.
5. Never restrict the movement of the turntable.
6. If glass tray or turntable ring assembly cracks or breaks, contact your nearest authorized service center.

# OPERATION



	Microwave/ Grill/Combi.
	Weight/Time Defrost
	Kitchen Timer/ Clock
	Stop/Clear
	Start/ +30SEC./Confirm
	Auto Menu
	Timer
	Weight

# Operation Instructions

## 1.Clock Setting

When the microwave oven is electrified, the screen will display "0:00", buzzer will ring once.

- 1). Press "Kitchen Timer/Clock" twice to select clock function, the hour figures will flash.
- 2). Turn "👆" to adjust the hour figures, the input time should be within 0--23.
- 3). Press "Kitchen Timer/Clock", the minute figures will flash.
- 4). Turn "👆" to adjust the minute figures, the input time should be within 0--59.
- 5). Press "Kitchen Timer/Clock" to finish clock setting. ":" will flash, and the time will light.

### Note:

- 1). If the clock is not set, it would not function when powered.
- 2). During the process of clock setting, if you do not press "Kitchen Timer/Clock", in 1 minute, the oven will go back to the previous status automatically.

## 2.Microwave Cooking

Press "Microwave/Grill/Combi." once, the screen will display "800W". Press "Microwave/Grill/Combi." repeatedly or turn "👆" to choose the power you want, "800W", "640W", "400W", "240W", "80W", "G", "C-1" or "C-2" will display for each added press. Then press "Start/+30Sec./Confirm" to confirm, and turn "👆" to set cooking time from 0:05 to 95:00. Press "Start/+30Sec./Confirm" again to start cooking.

Example: If you want to use 80% microwave power to cook for 20 minutes, you can operate the oven as the following steps.

- 1). Press "Microwave/Grill/Combi." once, the screen displays "800W".
- 2). Press "Microwave/Grill/Combi." once again or turn "👆" to choose 80% microwave power.
- 3). Press "Start/+30Sec./Confirm" to confirm, and the screen displays "640W".
- 4). Turn "👆" to adjust the cooking time until the oven displays "20:00".
- 5). Press "Start/+30Sec./Confirm" to start cooking.

**Note:** the step quantities for the adjustment time of the coding switch are as follow:



0---1 min	: 5 seconds
1---5 min	: 10 seconds
5---10 min	: 30 seconds

10---30 min : 1 minute  
30---95 min : 5 minutes



### " Microwave/Grill/Combi " Pad instructions

Order	Display	Microwave Power	Grill Power
1	800W	100%	
2	640W	80%	
3	400W	50%	
4	240W	30%	
5	80W	10%	
6	G	0%	100%
7	C-1	55%	45%
8	C-2	36%	64%

### 3.Grill or Combi. Cooking

Press " Microwave/Grill/Combi." once, the screen will display "800W". Press " Microwave/Grill/Combi." repeatedly or turn  to choose the power you want, and "800W", "640W", "400W", "240W", "80W", "G", "C-1" or "C-2" will display for each added press. Then press " Start/+30Sec./Confirm " to confirm, and turn  to set cooking time from 0:05 to 95:00. Press " Start/+30 Sec./Confirm " again to start cooking.

Example: If you want to use 55% microwave power and 45% grill power(C-1) to cook for 10 minutes, you can operate the oven as the following steps.

- 1). Press " Microwave/Grill/Combi. " once, the screen displays "800W".
- 2). Press " Microwave/Grill/Combi." for times or turn  to choose combi. 1 mode.
- 3). Press " Start/+30Sec./Confirm " to confirm, and the screen displays "C-1".
- 4). Turn  to adjust the cooking time until the oven displays "10:00".
- 5) Press " Start/+30Sec./Confirm " to start cooking.



**Note:** If half the grill time passes, the oven sounds twice, and this is normal. In order to have a better effect of grilling food, you should turn the food over, close the door, and then press " Start/+30Sec./Confirm " to continue cooking. If no operation, the oven will continue working.

### 4.Defrost By Time

- 1). Press " Weight/Time Defrost " twice , and the oven will display "dEF2".
- 2). Press " Start/+30Sec./Confirm " to confirm.

- 3). Turn "  " to set the cook time, the range of the time is "00:05-95:00".
- 4). Press " Start/+30Sec./Confirm " to start cooking.

## 5.Defrost By Weight

- 1). Press " Weight/Time Defrost " once, and the oven will display "dEF1".
- 2). Press " Start/+30Sec./Confirm " to confirm.
- 3). Press " Weight/Time Defrost " repeatedly or turn "  " to select defrost menu, "d01","d02","d03","d04" will display in order.
- 4). Press " Start/+30Sec./Confirm " to confirm.
- 5). Turn "  " to select the weight of food.
- 6). Press "Start/+30Sec./Confirm " to start defrosting.

<b>Menu</b>	d01 Frozen bread	d02 Frozen meat	d03 Frozen vegetable	d04 Frozen pizza
<b>Weight</b>	100g-600g	100g-2000g	100g-1000g	100g-600g

## 6.Kitchen Timer

- 1). Press " Kitchen Timer/Clock " once, the screen will display 00:00.
- 2). Turn "  " to enter the correct time. (The maximum cooking time is 95 minutes.)
- 3). Press " Start/+30Sec./Confirm " to confirm setting.
- 4). When the kitchen time is reached, the buzzer will ring 5 times.  
If the clock has been set (24-hour system), the screen will display the current time.

### Note:

During the Kitchen Timer, any programs can not be set.

## 7.Quick Start

- 1). In waiting state, Press " Start/+30Sec./Confirm " to start 30 seconds cooking with 100% power, each added press will increase 30 seconds cooking time up to 95 minutes.
- 2). In waiting state, turn "  " left to set cooking time with 100% microwave power, then press " Start/+30Sec./Confirm " to start cooking.

**Note:** In microwave, grill, combination cooking, time defrost state or multi-stage, each press of "Start/+30Sec./Confirm" can increase 30 seconds of cooking time.



## 8.Inquiring Function

- 1). In states of microwave, grill and combination cooking, press " Microwave/Grill/Combi. " the current power will be displayed for 3 seconds. After 3 seconds, the oven will turn back to the former state.
- 2). In cooking state, press " Kitchen Timer/Clock " to inquire the time and the time will display for 3 seconds.

## 9. Multi-section cooking

At most 2 sections can be set for cooking. In multi-section cooking, if one section is defrosting, then defrosting shall be placed in the first section. Kitchen Timer and Auto Menu can not be in multi-section cooking. Each one more press on " Start/+30Sec./Confirm " can increase the time by 30 seconds (except weight defrost).

Example: If you want to defrost food for 5 minutes and then cook with 80% microwave power for 7 minutes, operate it as the following:

- 1). Press " Weight/Time Defrost " twice, and the oven will display "dEF2".
- 2). Press " Start/+30Sec./Confirm " to confirm.
- 3). Turn "  " to select the defrost time till "5:00" displays.
- 4). Press " Microwave/Grill/Combi. " once, the screen displays "800W".
- 5). Press " Microwave/Grill/Combi. " once again or turn "  " to choose 80% microwave power.
- 6). Press " Start/+30Sec./Confirm " to confirm, and the screen displays "640W".
- 7). Turn "  " to adjust the cooking time till the oven displays "7:00".
- 8). Press " Start/+30Sec./Confirm " to start cooking, and buzzer will sound once for the first section, defrosting time counts down. Buzzer will sound once again entering the second cooking. When cooking finishes, buzzer sounds five times.

## 10. Lock-out Function for Children

Lock: In waiting state, press " Stop/Clear " for 3 seconds, there will be a long beep denoting entering the children lock state. LED will display the child-lock state or the current time.

Lock quitting: In locked state, press " Stop/Clear " for 3 seconds, there will be a long "beep" denoting that the lock is released.

## 11. ECO Function

To enter ECO mode:

In waiting state, press " Stop/Clear " to enter the ECO mode. The screen will go out.

To cancel ECO mode:

In ECO mode, press any keys or turn "  " to exit the ECO mode.

## 12. Silent mode

To activate the silent mode:

In waiting state, press and hold " Kitchen Timer/Clock " for 3 seconds. A long beep will sound and the oven will enter silent mode. When you press the keys, it does not make a sound.

To deactivate the silent mode:

In silent mode, press and hold "Kitchen Timer/Clock " for 3 seconds. A long beep will sound and the oven will exit silent mode.

### 13.Aquaclean Function

To enter the Aquaclean mode:

In waiting state, press and hold " Microwave/Grill/Comni. " for 3 seconds. A long beep will sound and the oven will enter aquaclean mode.

Put 200ml of water inside, and then press" Start/+30Sec./Confirm " to start the Aquaclean function with 800W power level and 5 minutes which can not be changed.

### 14.Auto Menu

1). Turn "  " right to choose the menu, and "A1" to "A15" will display.

2). Press " Start/+30Sec./Confirm " to confirm.

3). Turn "  " to choose the default weight as the menu chart.

4). Press " Start/+30Sec./Confirm " to start cooking.

Example: If you want to use "Auto Menu" to cook fish for 350g.

1). Turn "  " clockwise till "A1" displays.

2). Press " Start/+30Sec./Confirm " to confirm.

3). Turn "  " to select the weight of fish till "350" displays.

4). Press " Start/+30Sec./Confirm " to start cooking.

### Menu Chart

Menu	Weight	Display
A-1 Pizza	200 g	200g
	400 g	400g
A-2 Reheat plate	200 g	200 g
	400 g	400 g
	600 g	600 g
A-3 Melt chocolate	100 g	100 g
	150 g	150 g
	200 g	200 g
A-4 Melt butter	100 g	100 g
	150 g	150 g
	200 g	200 g
A-5 Meat(Beef)	250 g	250 g
	350 g	350 g
	450 g	450 g

<b>Menu</b>	<b>Weight</b>	<b>Display</b>
A-6 Meat(pork)	250 g	250 g
	350 g	350 g
	450 g	450 g
A-7 Meat (chicken)	250 g	250 g
	350 g	350 g
	450 g	450 g
A-8 Vegetable	200 g	200 g
	300 g	300 g
	400 g	400 g
A-9 Pasta	50g(with cold water 450g)	50 g
	100g(with cold water 800g)	100 g
A-10 Potato	200 g	200 g
	400 g	400 g
	600 g	600 g
A-11 Fish	250 g	250 g
	350 g	350 g
	450 g	450 g
A-12 Reheat soup	200ml	200
	400ml	400
	600ml	600
A-13 Pocporn	100 g	100
A-14 Chicken nuggest	200 g	200g
	400 g	400g
	600 g	600g
A-15 Minced meat	4	4

# Installation Instructions

## Installation and connection

- This appliance is only intended for domestic use.
- This oven is intended for built-in use only. It is not intended for counter-top use or for use inside a cupboard.
- Please observe the special installation instructions.
- The appliance can be installed in a 60cm wide wall-mounted cupboard.
- The appliance is fitted with a plug and must only be connected to a properly installed earthed socket.
- The mains voltage must correspond to the voltage specified on the rating plate.
- The socket must be installed and connecting cable must only be replaced by a qualified electrician. If the plug is no longer to accessible following installation, an all-pole disconnecting device must be present on the installation side with a contact gap of at least 3mm.
- Adapters, multi-way strips and extension leads must not be used. Overloading can result in a risk of fire.

**The accessible surface may be hot during operation.**



Please Read the Manual Carefully Before Installation

**Please Note**

**Electrical connection**

The oven is fitted with a plug and must be only connected to a properly installed earthed socket. In accordance with the appropriate regulations, the socket must only be installed and the connecting cable must only be replaced by a qualified electrician.

If the plug is no longer accessible following installation and all-pole isolating switch must be present on the installation side with a contact gap of at least 3mm.

 Screw A

 Screw B

 Mounting Plate

 Trim-kit plastic cover

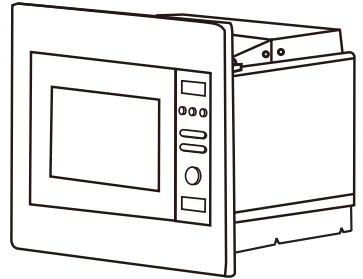

The built-in cabinet shall not have a rear wall behind the appliance.

Minimum installation height is 85cm.

Do not cover ventilation slots and air intake points.

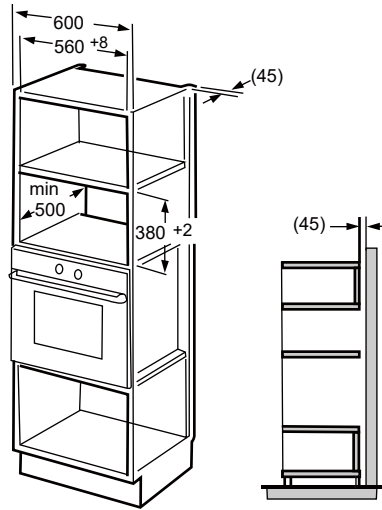
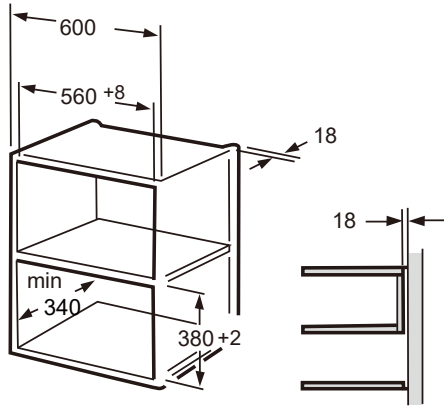

**Note:**

The bracket and bottom cabinet template are needed when installing in both installations.

## Prepare the cabinet

1. Read the instruction on the BOTTOM CABINET TEMPLATE , put the template on the bottom plane of cabinet.

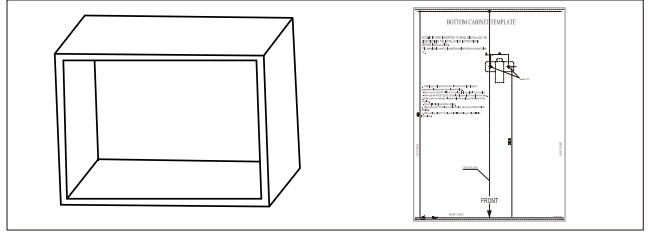

2. Make the marks on the bottom plane of cabinet according to marks "a" of the template

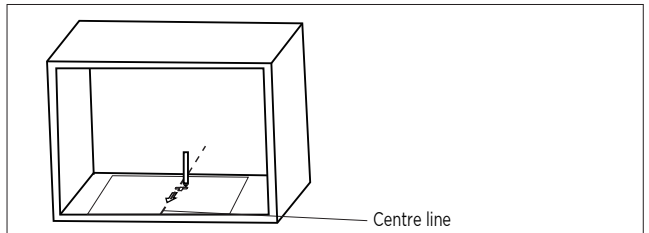

3. Remove the bottom cabinet template and fix the mounting plate with screw A.

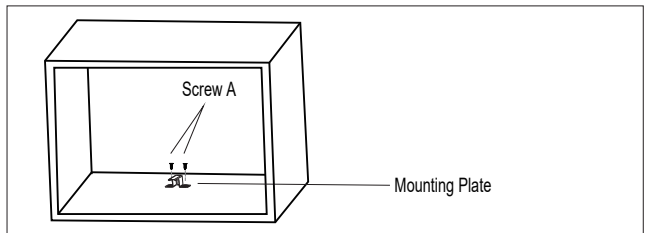

## Install the Oven

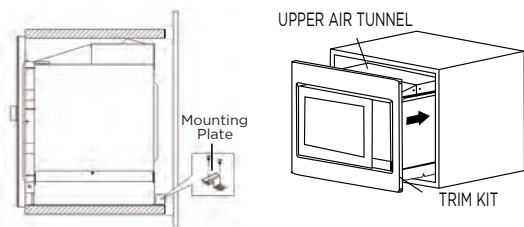

1. Fix ADJSUT SCREW A on the UPPER AIR TUNNEL of the oven, and then install the oven into the cabinet.
  - Adjust the height of ADJUST SCREW A to keep 1mm gap between the ADJUST SCREW A and the top plane of cabinet.
  - Do not trap or kink the power cord.
  - Make sure that the oven is installed in the center of the cabinet.

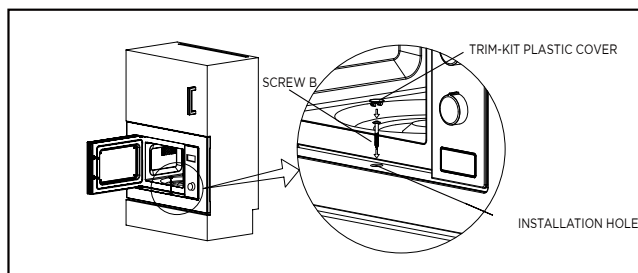

2. Open the door; fix the oven to the cabinet with SCREW B at the INSTALLATION HOLE of TRIM KIT. Then fix the TRIM-KIT PLASTIC COVER to the INSTALLATION HOLE.

## Specifications

Model:	.....BM201AG1X
Rated Voltage:	.....230V- 50Hz
Rated Input Power (Microwave):	.....1250W
Rated Output Power (Microwave):	.....800W
Rated Input Power (Grill):	.....1000W
Operating Frequency:	.....2450MHz
Outside Dimensions:	.....595mm(W)x388mm(H)x343.5 mm(D)
Oven Capacity:	.....20 litres
Weight:	.....Approx. 15kg
Noise level:	.....Lc < 63 dB (A)
Turntable diameter:	.....245 mm

## Energy consumption

Product information for power consumption and maximum time to reach applicable low power mode.

Off mode	0.5 W
Standby mode	0.8 W

The maximum time needed for the microwave oven to automatically reach the applicable low power mode or condition. 20 minutes

# Trouble shooting

Normal	
Microwave oven interfering TV reception	Radio and TV reception may be interfered when microwave oven operating. It is similar to the interference of small electrical appliances, like mixer, vacuum cleaner, and electric fan. It is normal.
Dim oven light	In low power microwave cooking, oven light may become dim. It is normal.
Steam accumulating on door, hot air out of vents	In cooking, steam may come out of food. Most will get out from vents. But some may accumulate on cool place like oven door. It is normal.
Oven started accidentally with no food in.	It is forbidden to run the unit without any food inside. It is very dangerous.

Trouble	Possible Cause	Remedy
Oven cannot be started.	(1). Power cord is not plugged in tightly.	Unplug. Then plug again after 10 seconds.
	(2). Fuse blowing or circuit breaker works.	Replace fuse or reset circuit breaker (repaired by professional personnel of our company)
	(3). Trouble with outlet.	Test outlet with other electrical appliances.
Oven does not heat.	(4). Door is not closed well.	Close door well.



According to Waste of Electrical and Electronic Equipment (WEEE) directive, WEEE should be separately collected and treated. If at any time in future you need to dispose of this product please do NOT dispose of this product with household waste. Please send this product to WEEE collecting points where available.

## GUARANTEE & SERVICE

If you need information or if you have a problem, please contact the Gorenje Customer Care Centre in your country (you find its phone number in the worldwide guarantee leaflet). If there is no Customer Care Centre in your country, go to your local Gorenje dealer or contact the Service department of Gorenje domestic appliances.

Eventual mismatches in colour shades between different appliances or components within a single design line may occur due to various factors, such as different angles under which the appliances are observed, different coloured backgrounds, materials, and room illumination.

### **For personal use only!**

Additional recommendations for cooking with microwave and useful advices can be found on web side:

<http://www.gorenje.com>

**WISHES YOU A LOT OF PLEASURE WHILE USING  
YOUR APPLIANCE**

# **gorenje**

We reserve the right to any changes and errors in the instructions for use.

[www.gorenje.com](http://www.gorenje.com)