



## Installation Instructions & Owner's Manual

### HomeShield™ Whole House Water Filter With PFAS<sup>1</sup> Reduction



#### Model AOS-HS-1200

<sup>1</sup>PFAS substances include: PFNA, PFOA, PFOS, PFHpA, PFHxS.

# Table of Contents

Installation .....	3
Start-up Instructions.....	5
Performance Data Sheet .....	7
Troubleshooting Guide .....	8
Replacement Parts .....	12
Installation Fitting Assemblies .....	13
Warranty.....	14
Quick Reference Guide.....	15

PRODUCT INFORMATION	
MODEL NUMBER	_____
SERIAL NUMBER	_____
DEALER INFORMATION:	
	_____
	_____
	_____

*Your A. O. Smith water filter is a precision built, high-quality product. These units will deliver filtered water for many years to come when installed and operated properly. Please study this manual carefully and understand the cautions and notes before installing. This manual should be kept for future reference. If you have any questions regarding your water filter, contact your local dealer.*

# Installation

## GENERAL INSTALLATION & SERVICE WARNINGS

The In/Out Head, fittings and bypass are designed to accommodate minor plumbing misalignments. There is a small amount of “give” to properly connect the piping, but the water treatment unit is not designed to support the weight of the plumbing.

Do not use Vaseline, oils, other hydrocarbon lubricants, or spray silicone anywhere. A silicone lubricant may be used on black O-Rings, but is not necessary. **Avoid any type of lubricants, including silicone, on red or clear lip seals.**

**Do not use pipe dope or other sealants on threads.** Plumber’s tape free of PFOA, PFOS, PFHpA, PFHxS, and PFNA must be used on the threads of the 1” NPT inlet and outlet connections. Plumber’s tape is not used on the nut connections or caps because “O” Ring seals are used. The nuts and caps are designed to be unscrewed or tightened by hand or with the special plastic Service Wrench, #100249864 (CV3193-02). If necessary, pliers can be used to unscrew the nut or cap. Do not use a pipe wrench to tighten nuts or caps. **Do not place screwdriver in slots on caps and/or tap with a hammer.**

**System Replacement Notice:** During service of the system at the end of the rated capacity or any service requiring replacement of the mineral tank, its internal content, reducer bushing, or In/Out Head, the entire water treatment device will be replaced.

## SITE REQUIREMENTS

- 5 Micron Pre-Filter\*
- 1” FNPT x 1” FNPT Coupling\*
- Water Pressure: 25-100 psi
- Water Temperature: 40-100°F (0.5-38°C)
- Water quality conditions: Reference **page 5\***
- Total height of system 59.5”; Total width of system 15.5” (tank diameter 12”)

\* Not tested by WQA or included in NSF/ANSI 53, CSA B483.1 certification.

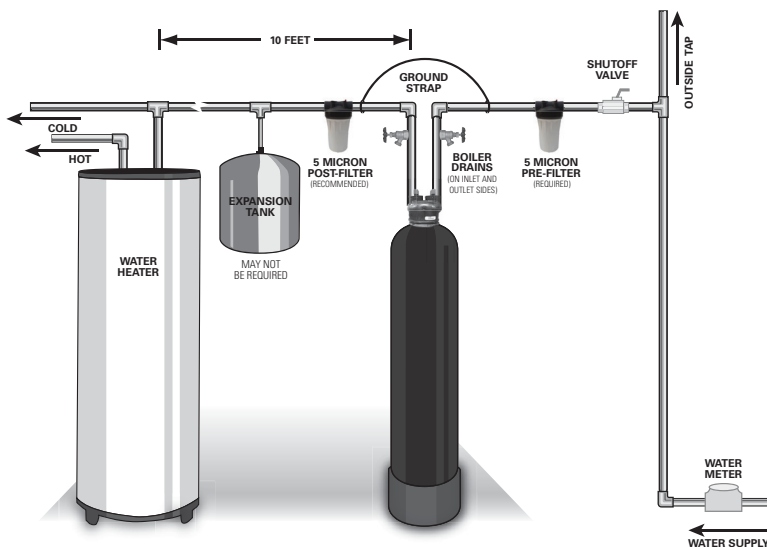

**MUNICIPAL INSTALLATION**

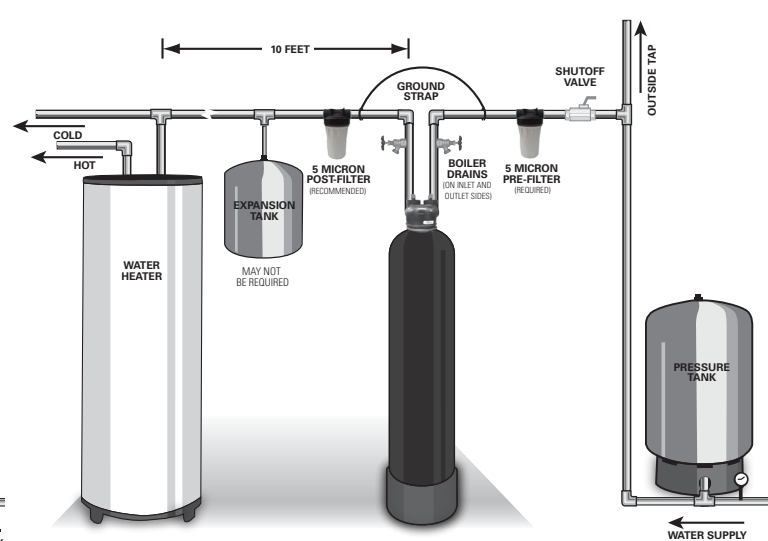

**WELL WATER INSTALLATION**

1. The distance between the drain and the water filter should be as short as possible.
  2. The media tank should be installed on a firm, level surface (above or below grade).
  3. It is NOT recommended to install any water treatment unit with less than 10 feet of piping between its outlet and the inlet of a water heater.
- CAUTION:** To protect the unit in the event of a hot water backup, the manufacturer recommends the use of an expansion tank on the outlet side of the unit (see diagram).
4. Do not locate unit where it or its connections will ever be subjected to temperatures under 33°F.
  5. Do not subject the tank to any vacuum as this may cause an “implosion” and could result in leaking. If there is a possibility a vacuum could occur, please make provisions for a vacuum breaker in the installation.
  6. If a flow restrictor is installed on the outlet side of the system, it should be installed on the outlet side of the PID.

OVERHEAD VIEW OF BYPASS VALVE

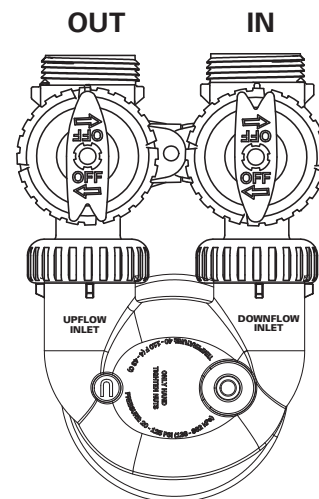

# Installation

## INLET/OUTLET PLUMBING

Be sure to install a Bypass Valve onto the In/Out Head before beginning plumbing. If it is desired to bypass outside hydrants or other locations, provisions should be made at this time. Install an inlet shutoff valve and plumb to the unit's bypass valve inlet located at the right rear as the threaded connections face away from you. There are a variety of installation fittings available. They are listed under the Installation Fitting Assemblies section of the manual. When assembling the installation fitting package (inlet and outlet), connect the fitting to the plumbing system first and then attach the nut, split ring, and O-Ring. Heat from soldering or solvent cements may damage the nut, split ring, or O-Ring. Solder joints should be cool and solvent cements should be set before installing the nut, split ring, and O-Ring. Avoid getting solder flux, primer, and solvent cement on any part of the O-Rings, split rings, bypass valve, or In/Out Head.

If the building's electrical system is grounded to the plumbing, install a copper grounding strap from the inlet to the outlet pipe. Plumbing must be done in accordance with all applicable local codes. Provisions should be made to bypass outside hydrants that are not to have filtered water. It is also advisable to install hose bibs on the inlet and outlet of the filter for future testing and service of the equipment. A pre-filter rated for 5 microns or lower needs to be installed immediately upstream of the HomeShield unit. If desired, a cartridge filter may be used after the system as a polishing filter.

## INSTALLING GROUND

To maintain an electrical ground in metal plumbing of a home's cold water piping (such as a copper plumbing system), install a ground clamp or jumper wiring.

**NOTE: If replacing an existing unit, also replace the ground clamps/wire. If removing a unit, replace the piping with the same type of piping as the original to assure plumbing integrity and grounding.**

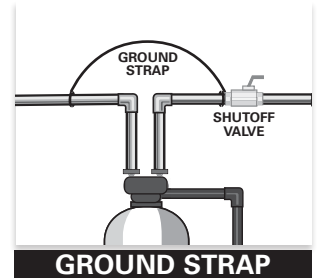

## SAFEGUARDS

- Do not use with water that is microbiologically unsafe or of unknown quality without adequate disinfection before or after the system.
- The system is to be supplied with **COLD** water only.
- The system and installation must comply with applicable state and local regulations.
- Manufacturer recommends annual testing of water quality. Please follow all sampling protocols specified by the testing laboratory.
- Do not bypass the system upon wetting the media until at least 24 hours have passed.
- The PID and power supply are water and dust resistant, but must be kept out of direct sunlight and water exposure.  
**NOTE: A dedicated environmental cover is not available for purchase from A. O. Smith.**
- If the PID power supply is installed lower than the PID and is in an environment that might be exposed to water, ensure there is an adequate drip loop in the USB cable immediately before the power supply.

- The allowable ambient temperature range of the PID is 40-140° Fahrenheit at 90% relative humidity.

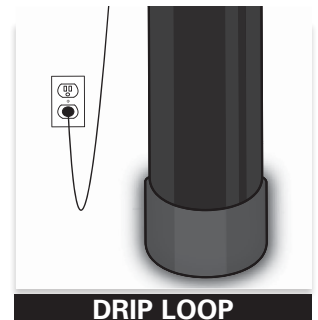

# Start-Up Instructions

## OPERATION

HomeShield requires no backwashing and eliminates the need for a control valve and the extra water needed to regenerate. Please contact A. O. Smith with any questions pertaining to the HomeShield Filter installation.

## OPERATING LIMITS

The unit is designed to function with minimum water pressures of 25 psi, maximum water pressures of 100 psi, a minimum water temperature of 40° F, and a maximum water temperature of 100° F.

## WATER QUALITY CONDITIONS

For the HomeShield to operate effectively, incoming water must be clear, sediment free, and meet the below water quality conditions:

- pH = 7-8
- Total Hardness < 10 gpg as CaCO<sub>3</sub>
- Iron < 0.3 ppm
- Manganese < 0.05 ppm
- Turbidity < 1 ntu
- Sulfate ≤ 200 ppm
- TOC ≤ 2 ppm
- Tannin < 0.1 ppm
- Hydrogen Sulfide = None
- Aluminum = None
- PFOA ≤ 500 ppt
- PFOS ≤ 1,000 ppt
- PFHpA ≤ 40 ppt
- PFHxS ≤ 300 ppt
- PFNA ≤ 50 ppt

*Application conditions will vary. Contact your regional sales manager or technical support for assistance with parameters outside those listed above.*

## IN/OUT HEAD

1. **CAUTION: Ensure the In/Out Head is tight on top of the tank. DO NOT overtighten.**
2. Locate the bypass valve assembly that is packaged with the system. The bypass valve has two red handles that allow you to bypass the unit, two threaded connections for the tail piece kit and two O-ring seal connections with nuts for the In/Out Head. Align the insert connection ends with O-rings and nuts to the inlet and outlet connections of the In/Out Head. Hand tighten the nuts.
3. Locate and assemble the tail piece kit. Align tail piece assembly to the bypass valve threaded inlet and insert until the nut can be tightened. Hand tighten the nuts.

## SERVICE LINE PIPING

1. Keep unit far enough away from walls and other obstructions to allow for servicing the unit. Pipe unit into the service lines. Plumb the inlet plumbing into the DOWNFLOW INLET port of the In/Out Head. Always follow local plumbing codes.
2. Install the Performance Indication Device (PID) by following the instructions below.
3. If sweat fittings are used, be sure soldering is done in such a manner as not to allow heat to reach the In/Out Head or bypass valve. If using copper pipe, make all sweat connections away from the tank, strainer, and head assemblies or the heat will damage them and void warranty. Use unions on the inlet and outlet connections.
4. Pipe a boiler drain into the inlet and outlet piping as shown in the drawings on page 3.

## FILLING FILTER WITH WATER

1. Direct water from the outlet boiler drain to a floor drain. With the bypass closed, open the outlet boiler drain and run water through the newly installed plumbing to drain.
2. Fully open the outlet bypass and SLIGHTLY crack open the inlet bypass. Once only water is running out the outlet boiler drain, fully open the inlet bypass and continue to flush the unit for at least 15 minutes, until it runs clear and free of air pockets.
3. Once the unit has been flushed, a surge flush is required to ensure the media is properly stratified. Open and shut the outlet boiler drain in 5 seconds open, 5 seconds shut intervals 15 times.
4. Make sure the inlet and outlet boiler drains are fully shut, and the bypass valves are fully open.
5. The unit is now in the service position.

## PERFORMANCE INDICATION DEVICE (PID)

1. **INSTALLATION** — The PID is a critical component of the system that informs the user when the HomeShield mineral tank requires replacement. If the PID is installed vertically, the water must be flowing upward through the PID. To install the PID:
  - a. Remove the PID from its packaging.
  - b. Apply plumber's tape (free of PFOA, PFOS, PFHpA, PFHxS, and PFNA) to the outlet, 1" MNPT tail piece.
  - c. Install a 1" FNPT by 1" FNPT coupling (**NOT INCLUDED**) onto the outlet (UPFLOW INLET as marked on In/Out Head), 1" MNPT tail piece.
  - d. Apply plumber's tape (free of PFOA, PFOS, PFHpA, PFHxS, and PFNA) to the inlet side of the PID (the side with the power supply connection – see figure on right).
  - e. Thread the PID Inlet into the open end of the 1" FNPT by 1" FNPT coupling.
  - f. Apply plumber's tape (free of PFOA, PFOS, PFHpA, PFHxS, and PFNA) to the PID Outlet.
  - g. Plumb the 1" MNPT PID Outlet to the outlet plumbing.
  - h. Remove the PID power supply from its packaging.
  - i. Connect the power adaptor to the connection on the PID (see figure on right).

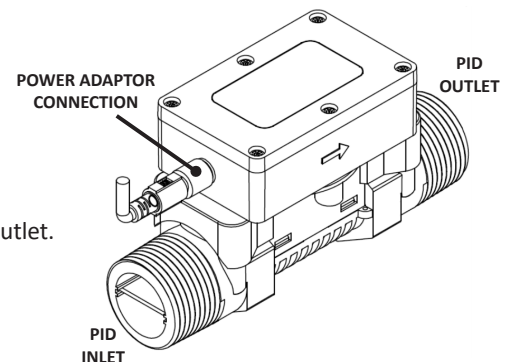

# Start-Up Instructions

- j. Connect the PID power transformer to a 115V/60Hz, properly grounded, dedicated electrical outlet. Avoid using outlets that are switch controlled.
  - k. Make sure the electrical service provides power 24 hours per day. Installing a surge protector to protect the unit from power surges (which are not covered by warranty) is recommended.
2. **INDICATOR SCREEN** — The HomeShield PID has three, color-coded display modes to easily identify replacement needs.
- a. **Green** = 500,000-50,000 gallons remaining
    - i. Touch the screen to activate the display. *Note: Display will shut off after 10 seconds of inactivity.*
  - b. **Yellow** = 50,000-0 gallons remaining
    - i. Tank has 10% or less of its certified capacity remaining and should be replaced soon. *Note: Display will always be on.*
  - c. **Red** = 0 gallons remaining
    - i. Tank has reached its maximum, certified capacity and should be replaced. *Note: Display will always be on.*
3. **HOW TO RESET** — If the PID needs to be reset, follow these steps:
- a. If necessary, press the display to activate it.
  - b. Press and hold the PID display for 10 seconds.
    - i. After 5 seconds, a blue square will appear in the upper right-hand corner to indicate the reset process has been initiated.
    - ii. Once the square turns red, release the display.
  - c. The display will change to read **Reset System**.
    - i. Select **No** to cancel the PID reset process and return to the main display.
    - ii. Select **Yes** to reset the device; the PID will count down for 5 seconds. The reset can be canceled if **Cancel** is selected within the 5-second window.
  - d. After selecting **Yes**, the PID will reset the Total Volume indicator and return to the default display.



# Performance Data

<b>Model No: AOS-HS-1200</b>
<b>Replacement Model No: AOS-HS-1200-R</b>
<b>Media Required: 2.5 cu. ft. Patent-pending Media Blend</b>
<b>Operating Pressure Range: 25-100 psi (172-689 kPa)</b>
<b>Operating Temperature Range: 40-100° F (4-38° C)</b>
<b>Rated Service Flow: 5.7 gpm (21.6 lpm) @ 4.9 psid</b>
<b>Flow Rate: 11.2 gpm @ 15 psid*</b>
<b>Rated Capacity: 500,000 gallons (1,892 kl)</b>
<b>Electrical Requirements: 12 V</b>
<b>Total Dimensions: 15.5"W x 59.5"H (Mineral Tank 12" x 52")</b>
<b>System Weight: 99 lbs</b>



Filter shown with PID installed.  
FNPT coupling not included.

*This system conforms to NSF/ANSI 53 for the specific performance claims as verified and substantiated by test data. The system has been tested according to NSF/ANSI 53 for reduction of the substances listed below. The concentration of the indicated substances in water entering the system was reduced to a concentration less than or equal to the permissible limit for water leaving the system, as specified in NSF/ANSI 53.*

*\*Claims are certified at 5.7 gpm. Claims are not performance tested by WQA. System is not validated for contaminant reduction at this flow rate. Frequent operation at this flow rate may reduce overall capacity.*

NSF/ANSI 53	Influent Challenge Concentration (mg/L)	Maximum Permissible Product Water Concentration (mg/L)	Overall % Reduction
PFOA/PFOS	0.0015 +/- 20% added as 1.0 µg/L PFOS and 0.5µg/L PFOA	0.00002	>99.9%
PFHpA	0.00004 ± 20%	0.00002	>99.9%
PFHxS	0.0003 ± 20%	0.00002	>99.9%
PFNA	0.00005 ± 20%	0.000006	>99.9%
Aesthetic Contaminants**	Influent Challenge Concentration (mg/L)	Minimum Reduction Requirement	Overall % Reduction
Chlorine	2.0 mg/L± 10%	≥ 50%	>97.4%

*All contaminants reduced by this filter are listed. Not all contaminants listed may be present in your water. Does not remove all contaminants that may be present in tap water. Filter is only to be used with cold water. Testing was performed under standard laboratory conditions; actual performance may vary.*

*\*\*Internally validated for Chlorine reduction. Not certified for Chlorine contaminant reduction by WQA.*

Influent Water Quality Requirements	
pH = 7-8	Tannin <0.1 ppm
Total Hardness <10 gpg as CaCO3	Hydrogen Sulfide OR Aluminum = None
Iron <0.3 ppm	PFOA ≤500 ppt
Manganese <0.05 ppm	PFOS ≤1,000 ppt
Turbidity <1 ntu	PFHpA ≤40 ppt
Sulfate ≤200 ppm	PFHxS ≤300 ppt
TOC ≤2 ppm	PFNA ≤50 ppt

*Application conditions will vary. Please contact your regional sales manager or technical support for assistance with parameters outside those listed above.*



System tested and certified by WQA to NSF/ANSI Standard 53 and CSA B483.1 for the reduction of the claims specified on the Performance Data Sheet and at WQA.org. Not certified for Chlorine contaminant reduction by WQA.



# Troubleshooting Guide

PROBLEM	CAUSE	CORRECTION
<b>1. No flow or low flow during start up.</b>	A. Main water line is not fully open.	A. Make sure main water line is turned on.
	B. Improper flushing or no flushing performed.	B. Perform flushing and surge flushing procedures (refer to start up instructions on page 5).
	C. Fines caught in post filter.	C. Check post-filter for flow restriction. Replace post-filter cartridge as necessary.
	D. In/Out head plumbed in backwards causing backflush.	D. Ensure In/Out head is plumbed in properly.
<b>2. Excess fines running through tank outlet during start up.</b>	A. Improper flushing or no flushing performed.	A. Perform flushing and surge flushing procedures (refer to start up instructions on page 5).
<b>3. Reducer bushing leaking.</b>	A. Reducer bushing not adequately tightened.	A. Further hand-tighten the reducer bushing.
	B. Reducer bushing is cross threaded.	B. Unthread reducer bushing and ensure it is on evenly.
	C. Missing, rolled or damaged O-ring.	C. Unthread reducer bushing and inspect O-ring. Reposition or replace O-ring as necessary.
<b>4. In/Out Head Leaking.</b>	A. Valve not tight enough.	A. Further hand-tighten In/Out head.
	B. In/Out head is cross threaded.	B. Unthread In/Out head and ensure it is on evenly.
	C. Missing, rolled, or damaged O-ring.	C. Unthread In/Out head from the reducer bushing and inspect O-ring.
<b>5. Bypass Leaking.</b>	A. Bypass threaded nuts not fully tightened.	A. Ensure threaded nuts on bypass valve are fully tightened.
	B. Threaded nuts are cross threaded.	B. Unthread threaded nuts on bypass and ensure they are on evenly.
	C. Missing, rolled, or damaged O-ring.	C. Detach bypass threaded nuts and inspect O-ring. Install, reposition, or replace O-ring as necessary.
	D. Missing or damaged snap ring.	D. Detach the bypass threaded nuts and inspect snap ring. Install, reposition, or replace snap ring as necessary.
<b>6. Connection Ports Leaking.</b>	A. Tail piece threaded nuts not fully tightened.	A. Ensure threaded nuts on tail pieces are fully tightened.
	B. Threaded nuts are cross threaded.	B. Unthread threaded nuts on tail pieces and ensure they are on evenly.
	C. Missing, rolled, or damaged O-ring.	C. Detach tail piece threaded nuts and inspect O-ring. Install, reposition, or replace O-ring as necessary.
	D. Missing or damaged snap ring.	D. Detach tail piece threaded nuts and inspect snap ring. Install, reposition, or replace snap ring as necessary.



# Troubleshooting Guide

PROBLEM	CAUSE	CORRECTION
<b>7. PID Leaking.</b>	A. Female to female connection to PID is not adequately tightened.	A. Ensure relevant connections between In/Out head, PID, and female to female connection are fully tightened.
	B. Connections are cross threaded.	B. Unthread the leaking connections and ensure they are on evenly.
	C. No plumber's tape free of PFOA, PFOS, PFHpA, PFHxS, and PFNA on threaded connections.	C. Unthread relevant connections and use at least two wraps to ensure proper sealing.
<b>8. Low flow or high pressure drop over lifetime of tank.</b>	A. Pre-filter is fouled.	A. Inspect and replace pre-filter as needed.
	B. Post-filter is fouled.	B. Inspect and replace post-filter as needed.
	C. Poor influent water quality causing fouling of media.	C. Refer to the Water Quality Conditions under Startup Instructions on page 5.
<b>9. Tank uneven or lopsided when standing up.</b>	A. Tank base is misaligned.	A. Use level or visual means to adjust tank base to ensure tank is leveled appropriately.
<b>10. PID not turning on.</b>	A. PID not plugged in.	A. Attach 4-pin power connector to PID, insert USB to power plug, insert power plug into outlet.
	B. PID connection is not fully intact.	B. Ensure each element is attached properly with tight fit.
<b>11. PID not counting flow accurately.</b>	A. PID is installed backwards.	A. Replumb the PID in proper orientation.
	B. Potential leaks in PID connection.	B. Refer to "PID leaking" section.
	C. PID is installed on inlet of In/Out head.	C. Install PID to outlet of In/Out head.
<b>12. PID not showing flow when there is water flowing through it.</b>	A. PID is not plugged in or powered correctly.	A. Refer to "PID not turning on" section above.
	B. PID is installed backwards.	B. Replumb PID in proper orientation.
<b>13. PID not changing colors when specified gallons is reached.</b>	A. Color change may not happen right away when gallons trigger is reached because there is +/- 5% accuracy with PID.	A. Wait few more gallons to trigger color change.
<b>14. Tank developing condensation.</b>	A. This is normal when influent water is <70 degrees Fahrenheit because influent water is colder than ambient temperature.	A. NA
<b>15. Tank making noises when water is flowing.</b>	A. Water can be heard flowing in tank. This is normal and shows anti-channeling and flow distribution technology is working.	A. NA
<b>16. Milky outlet water.</b>	A. If milkiness dissipates when water sits there could be air in filter, air in plumbing system, or minor leak in plumbing system or filter causing air draw.	A. Perform flushing and surge flushing procedures (refer to Startup Instructions on page 5). If issue persists, further flushing may be required. Check for and resolve any leaks.
	B. If milkiness does not dissipate when water sits, water may contain elevated aluminum or zinc.	B. Test water for aluminum and zinc, and install appropriate pre-treatment if necessary.



# Troubleshooting Guide

PROBLEM	CAUSE	CORRECTION
<b>17. Brown outlet water.</b>	A. If color settles when water sits, there is elevated iron/manganese concentrations in influent water or silt/sediment intrusion.	A. Refer to Water Quality Conditions under Startup Instructions on page 5. Evaluate existing or install new pre-treatment.
	B. If color does not settle when water sits, there is fine silt, suspended solids, or sediment intrusion.	B. Contact local water treatment dealer for assistance in identifying pre-treatment options.
<b>18. Suspended solids in outlet water.</b>	A. If solids settle when water sits, there is silt or sediment intrusion.	A. Evaluate existing or install new pre-treatment.
	B. If solids do not settle when water sits, there is fine silt, suspended solids, or sediment intrusion.	B. Contact local water treatment dealer for assistance in identifying pre-treatment options.
<b>19. Grey/black outlet water.</b>	A. Carbon fines in water because of improper flushing or no flushing performed.	A. Perform flushing and surge flushing procedures (refer to Startup Instructions on page 5). If issue persists, further flushing may be required.
	B. Compromised or damaged Vortech plate or distributor tube.	B. Contact local water treatment dealer for assistance.
	C. Elevated manganese concentrations in influent water.	C. Refer to the Water Quality Conditions under Startup Instructions on page 5. Evaluate existing or install new pre-treatment.
<b>20. Fishy odor from effluent water.</b>	A. Improper flushing or no flushing performed.	A. Perform flushing and surge flushing procedures (refer to Startup Instructions on page 5).
	B. pH levels are elevated in influent water.	B. Refer to the Water Quality Conditions under Startup Instructions on page 5. Test influent water to determine pH level. Evaluate existing or install new pre-treatment.
<b>21. Rotten egg odor from effluent water.</b>	A. Hydrogen Sulfide present in influent water.	A. Refer to the Water Quality Conditions under Startup Instructions on page 5. Evaluate existing or install new pre-treatment.
	B. Microbial fouling in carbon bed.	B. Test influent water quality for sulfate reducing bacteria. If found, contact local water treatment dealer for disinfection options.
<b>22. Musty odor from effluent water.</b>	A. Microbial contamination or pre-/post-filter fouling.	A. Inadequate disinfection of plumbing system after installation. Contact dealer to disinfect plumbing. Clean pre-filter housings and replace cartridges.
	B. Elevated microbial activity in influent water.	B. Contact water treatment dealer for disinfection options.
<b>23. Chalky water taste.</b>	A. Media fines in effluent water because of improper flushing or no flushing performed.	A. Perform flushing and surge flushing procedures (refer to Startup Instructions in product manual on page 5).
	B. Media fines in effluent water because of compromised or damaged Vortech plate or distributor tube.	B. Contact local water treatment dealer for assistance.



# Troubleshooting Guide

PROBLEM	CAUSE	CORRECTION
<b>24. Bitter water taste.</b>	A. Initial pH increase from media fines because of improper flushing or no flushing performed.	A. Perform flushing and surge flushing procedures (refer to Startup Instructions on page 5). If issue persists, further flushing may be required.
<b>25. Metallic water taste.</b>	A. Influent water pH is below minimum required level.	A. Refer to the Water Quality Conditions under Startup Instructions on page 5. Evaluate existing or install new pre-treatment.
<b>26. Insufficient contaminant reduction.</b>	A. Influent water conditions are not within system specifications.	A. Refer to the Water Quality Conditions under Startup Instructions on page 5. Evaluate existing or install new pre-treatment.
	B. Tank is visibly uneven.	B. Adjust tank base so tank is visually vertical.
	C. PID is not being used or operated properly, causing delay in changing tank.	C. Refer to “PID not counting flow accurately” and “PID not showing flow when there is water flowing through it” sections on page 9.
	D. Rated flow rate of 5.7 gpm is being exceeded.	D. Install an appropriately sized flow restrictor on outlet of system. Contact local water treatment dealer about installing additional water treatment units.
	E. Rated capacity of 500,000 gallons has been exceeded.	E. Contact local water treatment dealer about replacing tank assembly.
<b>27. Air in line/choppy water flow.</b>	A. Improper flushing or no flushing performed.	A. Perform flushing and surge flushing procedures (refer to Startup Instructions on page 5).
	B. Air in pre- or post filters.	B. Use air valves on pre- and/or post-filters to extract any air in them.
	C. Air in plumbing system.	C. Leave high-flow faucet and/or appliances on until air has been purged from tank or piping.



# Replacement Parts

## BYPASS VALVE

Item #.	Legacy Part #	Current Part #	Description	Qty.
1	CV3006	100249845	Bypass assembly	1
2	CV3147	100246284	Bypass handles	2

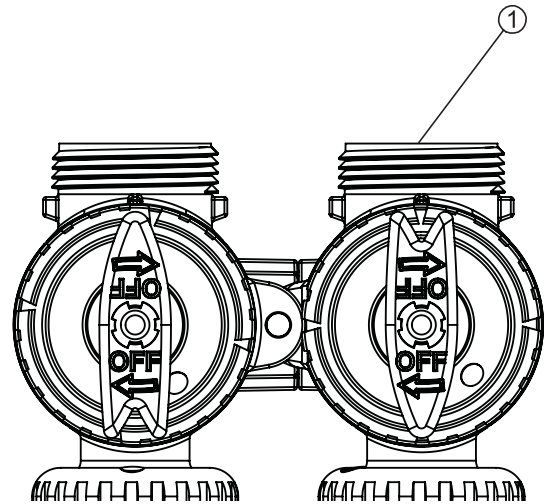

## IN/OUT HEAD

Item #	Legacy Part #	Current Part #	Description	Qty.
	CD1400	100245769	1191 In/Out Head	1
Not Shown	CV3180	100246307	Base O-Ring	1
	CV3105	100246272	Distributor Pilot O-Ring 215	1

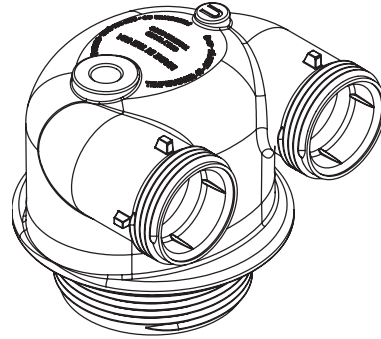

## REDUCER BUSHING

Item #	Legacy Part #	Current Part #	Description	Qty.
1	SF4821-2	100248785	4" x 2.5" Reducer	1
Not Shown	N/A	100247004	O-Ring, -343, Park Tank	1

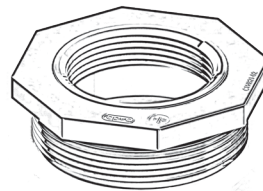

All components shown on this page are included with the system, and were present in the system tested by WQA.

# Installation Fitting Assemblies

NOTE: Not all available fittings are displayed below. Contact manufacturer for optional fittings.

For All Assemblies

Item #	Legacy Part #	Current Part #	Description	Qty.
1	CV3151	100246287	Nut, 1" quick connect	2
2	CV3150	100246286	Split ring	2
3	CV3105	100246272	O-ring 215	2

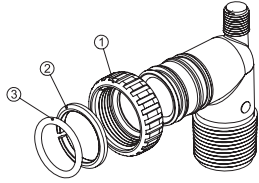

Legacy Part #	Current Part #	Description	Qty.
CV3007*	100246197	1" PVC male NPT elbow assembly	2

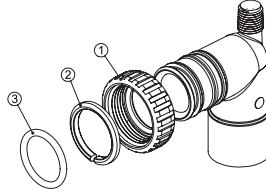

Legacy Part #	Current Part #	Description	Qty.
CV3007-01**	100246198	3/4" & 1" PVC solvent elbow assembly	2

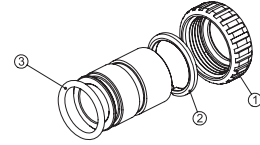

Legacy Part #	Current Part #	Description	Qty.
CV3007-02**	100246199	1" brass sweat assembly	2

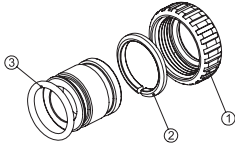

Legacy Part #	Current Part #	Description	Qty.
CV3007-03**	100249846	3/4" brass sweat assembly	2

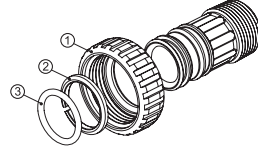

Legacy Part #	Current Part #	Description	Qty.
CV3007-04**	100244506	1" plastic male NPT assembly	2

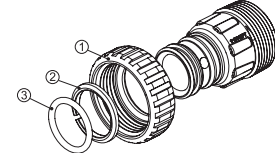

Legacy Part #	Current Part #	Description	Qty.
CV3007-05**	100243921	1-1/4" plastic male assembly	2

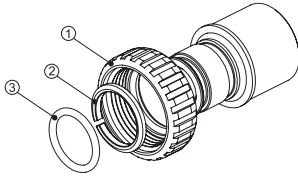

Legacy Part #	Current Part #	Description	Qty.
CV3007-09**	100243922	1-1/4" & 1-1/2" brass sweat assembly	2

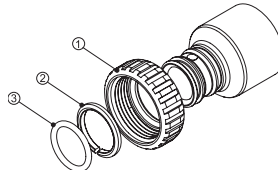

Legacy Part #	Current Part #	Description	Qty.
CV3007-07**	100243375	1-1/4" & 1-1/2" PVC solvent assembly	2

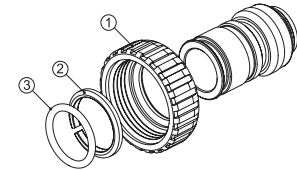

Legacy Part #	Current Part #	Description	Qty.
CV3007-12**	100249847	3/4" brass shark bite assembly	2

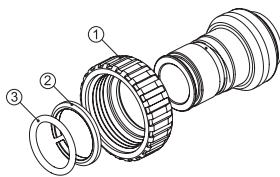

Legacy Part #	Current Part #	Description	Qty.
CV3007-13**	100249848	1" brass shark bite assembly	2

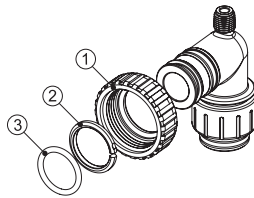

Legacy Part #	Current Part #	Description	Qty.
CV3007-15**	100246200	3/4" john guest elbow assembly	2

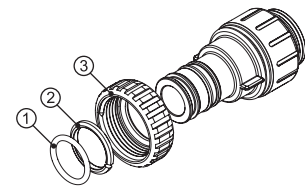

Legacy Part #	Current Part #	Description	Qty.
CV3007-17**	100245045	1" john guest assembly	2

\*Default fitting for HomeShield unit.

\*\*Not tested by WQA or included in NSF/ANSI 53, CSA B483.1 certification.



## HomeShield™ Filter Limited Warranty

Congratulations. You have purchased one of the finest water treatment systems available. In the unlikely event of a problem due to defects in material and workmanship, we proudly warrant our water filters to the original owner, when installed in accordance with A. O. Smith® specifications. This warranty is effective from the date of original installation for:

**500,000 Gallons or a period of  
TEN YEARS:**

**Fiberglass mineral tank; except for damages due to freezing, high pressure (100 PSI and above), extreme temperature (100°F and above) or a vacuum on the system.**

**500,000 Gallons or a period of  
FIVE YEARS:**

**In/Out Head.**

**500,000 Gallons or a period of  
TWO YEARS:**

**Performance Indication Device (PID).**

**500,000 Gallons or a period of  
ONE YEAR:**

**All other filter components.**

Any part found defective within the terms of this warranty will be repaired or replaced by the dealer. You pay only freight from our factory and local dealer charges. To obtain local warranty service, contact original dealer or an authorized service dealer. If no authorized dealer is located in your area, please ship defective part or component freight prepaid to A. O. Smith, 1900 Prospect Ct., Appleton, Wisconsin 54914. A. O. Smith, at its discretion, will repair or replace the part or component at its expense and return part freight collect.

The above provisions of the warranty are valid as long as the unit is installed, operated, and maintained in accordance with the printed Manufacturer's instructions and specifications, is connected in compliance with local plumbing codes and in an equivalent manner and condition of the original installation, and is owned by the original owner.

This warranty does not cover damages due to accident, fire, flood, freezing, or any other Act of God. We are not responsible for damages due to change in water conditions, misapplication, misuse, neglect, vacuum, oxidizing agents, alteration, or lack of maintenance. No responsibility is assumed for loss of use of the unit, inconvenience, loss or damage to real or personal property or any incidental or consequential damages. Furthermore, we assume no liability and extend no warranties, express or implied, for the use of this product with a non-potable water source. **To the extent permitted by law, A. O. Smith disclaims all implied warranties, including without limitation warranties of merchantability and fitness for particular purpose; to the extent required by law, any such implied warranties are limited in duration to the aforementioned period specified above.**

Some states do not allow the exclusion of implied warranties or limitations on how long an implied warranty lasts. Consequently, the above limitation may not apply to you.

This warranty gives you specific legal rights, and you may also have other rights which vary from state to state.

# Quick Reference Guide

## BYPASS VALVE OPERATION

To shut off water to the system, position arrow handles as shown in the bypass operation diagram below. If your valve doesn't look like the diagram below, contact your service technician for instructions on how to shut off water.

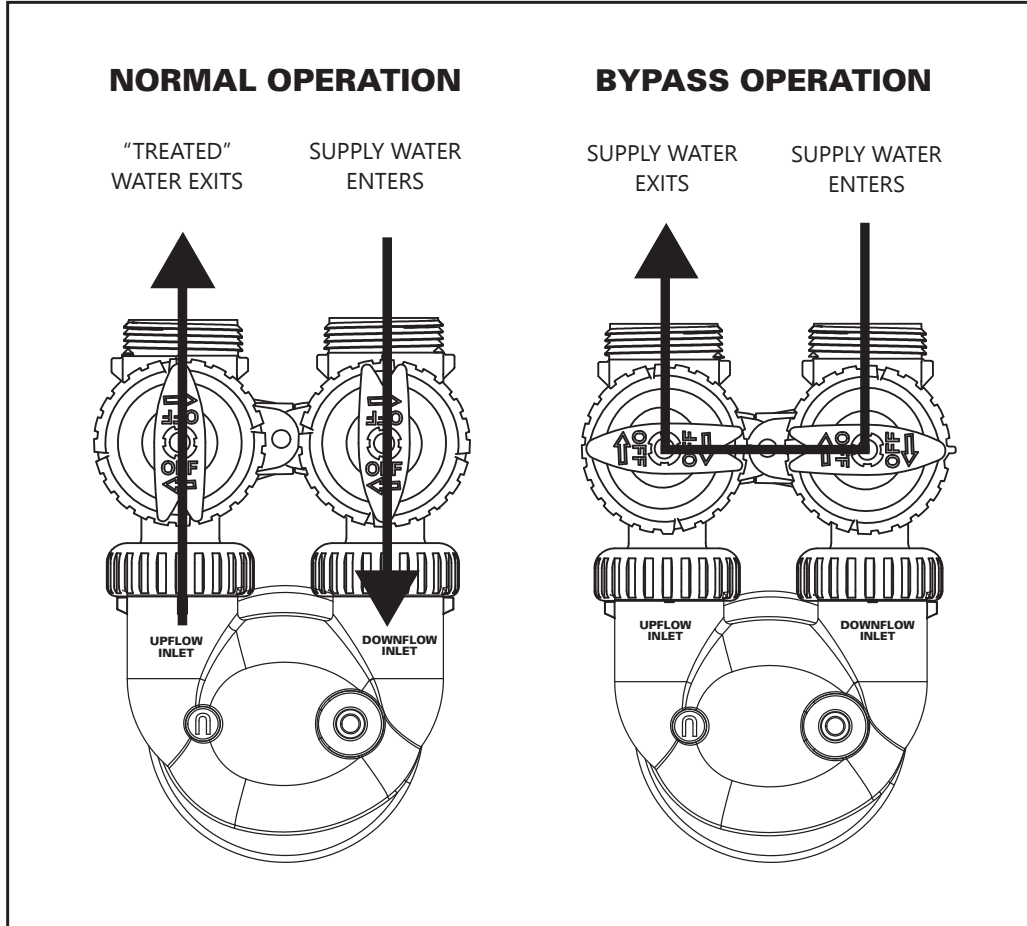



© 2025 A.O. Smith, Inc. All rights reserved.

AOS-HS-1200 MAN - 100389057 - 2000843534 - RevB0825



C US

