

Server Express®

Used with pouches up to
1½ gallons with 16mm fitments.

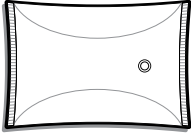

MODELS:

- SE
- SE-SS
- SS-1SE
- SS-2SE
- SE-2
- SE-3
- SE-3DI
- SE-4
- SE-4DI
- SE-5
- SE-5DI

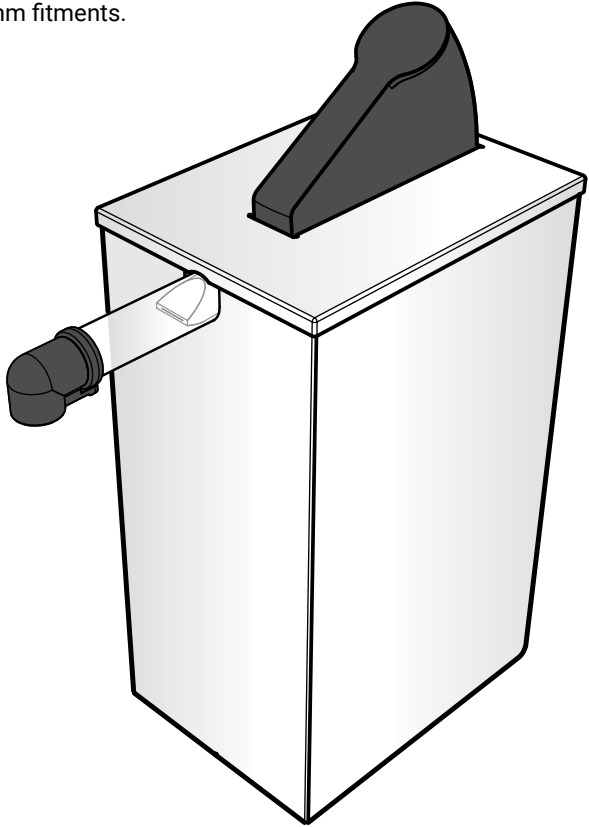

Thank You

for purchasing our Server Express® Pouched Condiment Dispenser. This portion controlled unit is sealed and sanitary, achieves excellent evacuation and has only a few parts for easy clean-up.

SIMPLIFY CONDIMENT MANAGEMENT— GO POUCHED

SERVER EXPRESS® MODELS

Your model may vary.
See pages 2–4.
Examples include:

SS-1SE
67760

Rectangular Single Stand

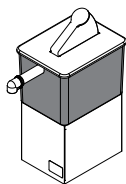

SE
07000

Rectangular Black

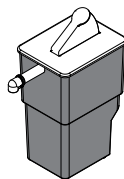

SS-2SE
07300

Twin Stand

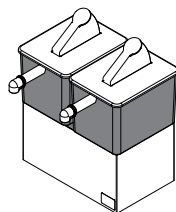

PARTS

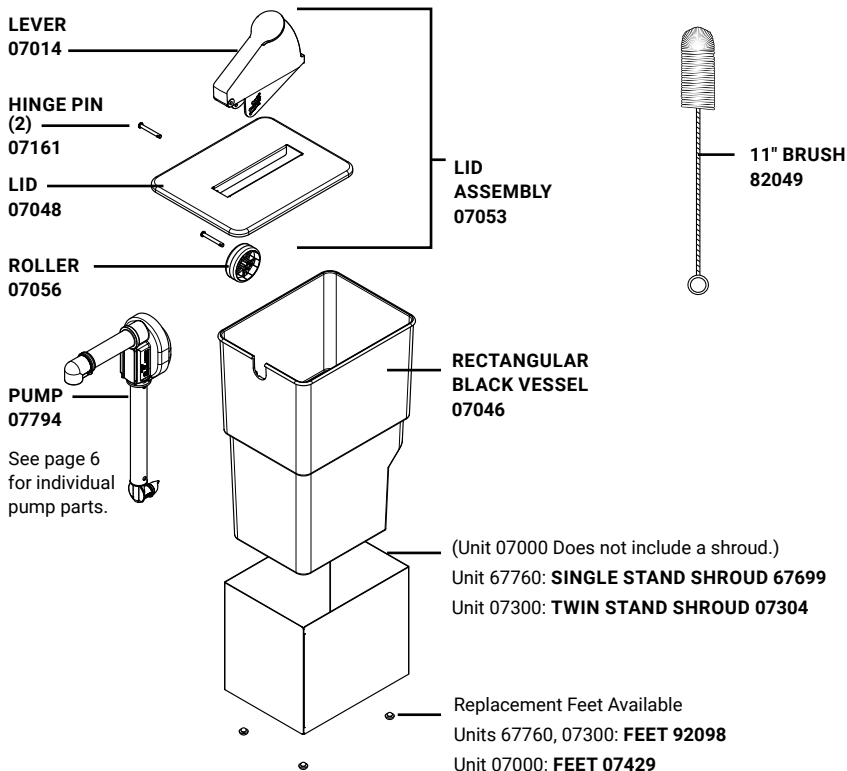

SERVER EXPRESS® MODEL

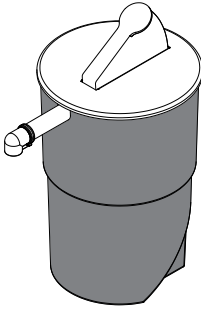

SE
07010
Round Black

PARTS

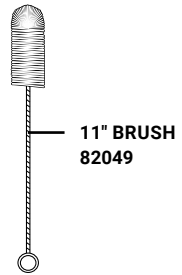
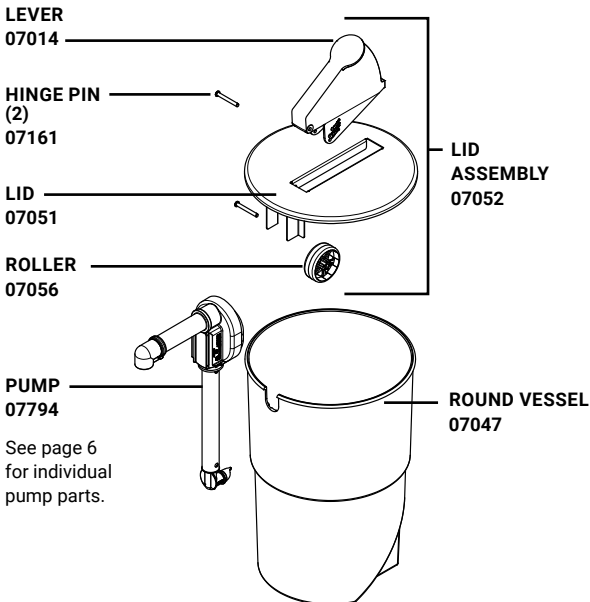

SERVER EXPRESS® MODELS

SE-SS
07125
Single

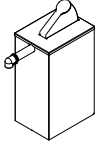

SE-SS
07020
Single Drop-In

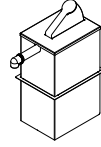

SE-2
07140
Twin

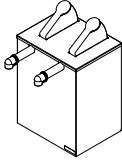

SE-3DI
07050
Triple Drop-In

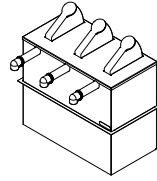

SE-3
07040
Triple

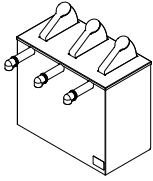

SE-4DI
07210
Quadruple Drop-In

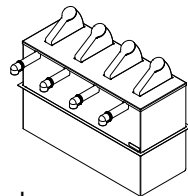

SE-4
07200
Quadruple

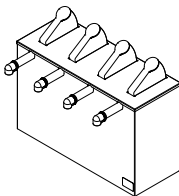

SE-5DI
07070
Quintuple Drop-In

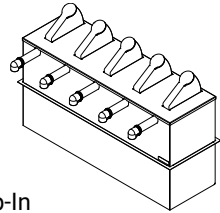

SE-5
07060
Quintuple

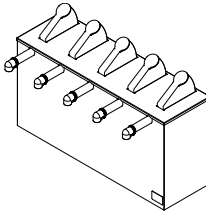

PARTS

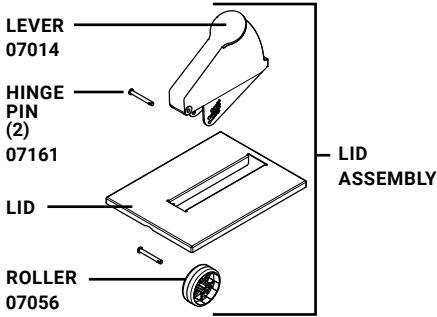

MODEL(S)	LID	LID ASSEMBLY
07125, 07020	07055	07057
07140	07341	07342
07040, 07050	07079	07083
07200, 07210	07185	07186
07060, 07070	07104	07105

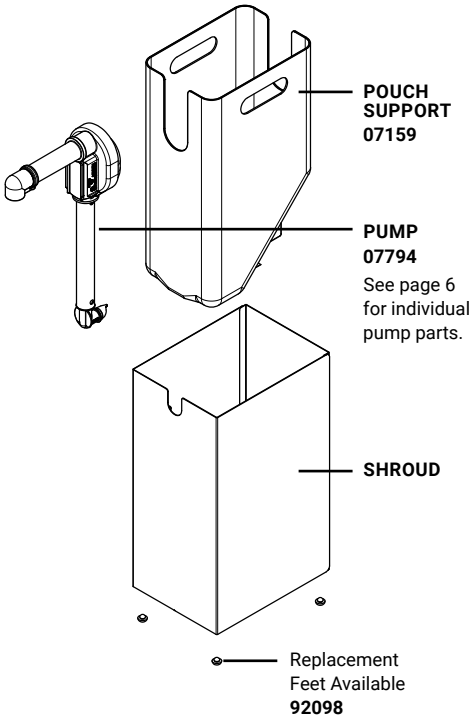

For Express Singles, an 07159 pouch support may be substituted with a 100280 vessel. These parts are interchangeable and function the same.



100280 VESSEL

MODEL	REPLACEMENT SHROUD
07125	07345
07020	07327
07140	07343
07040	07328
07050	07329
07200	07331
07210	07332
07060	07333
07070	07334

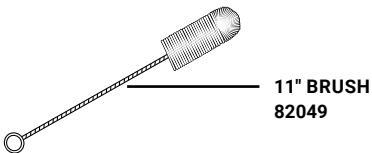

SAFETY



According to food and safety regulations, most foods must be stored and/or served at certain temperatures or they could become hazardous. Check with local food and safety regulators for specific guidelines. Server Products, Inc. cannot be responsible for the serving of potentially hazardous product.

IMPORTANT

Clean, rinse, sanitize, and dry parts daily or regularly to comply with local sanitization requirements.



NSF International lists this pump as:
"Not acceptable for dispensing potentially hazardous foods."

ADA
compliant

DROP-IN UNITS

Drop-in units can be used either on a countertop surface or can be dropped into an opening in a countertop.

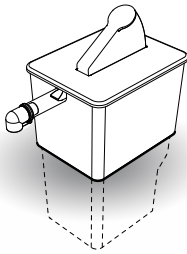

MODEL NUMBER

RECOMMENDED COUNTERTOP OPENING SIZE

07000, 07020

6 3/8" x 8 1/2"

07010

8 1/2" diameter

07050

16 3/8" x 8 1/2"

07210

21 13/16" x 8 1/2"

07070

27 3/16" x 8 1/2"

PUMP MODEL 07794

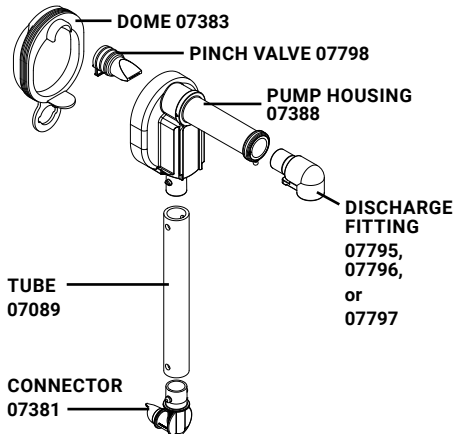
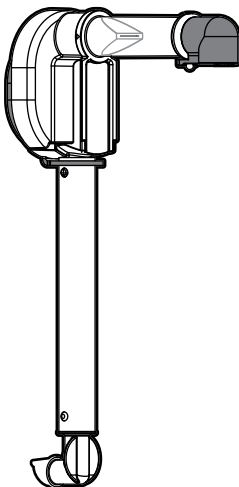

PUMP ASSEMBLY

WASH ALL PARTS
PROPERLY BEFORE USE. See page 11.

1 INSERT PINCH VALVE

into pump housing.

TIP: Squeeze the pinch valve open before installation to ensure it isn't stuck shut.

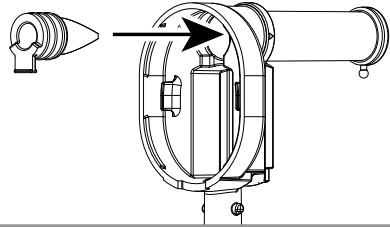

2 INSTALL DOME

Press dome into housing fully. Ensure valve flap covers bottom opening.

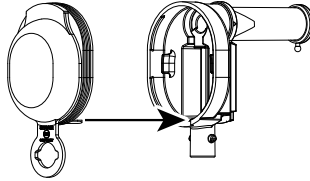

Wrap loop around lower opening to secure dome.

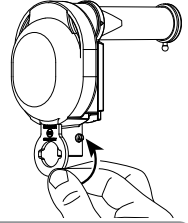

3 INSTALL TUBE

Lubricate with a small amount of clean water. Rotate and position until both pegs on housing fit into holes on tube.

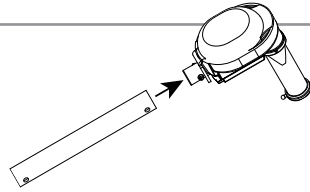

4 INSERT CONNECTOR

Lubricate with a small amount of clean water. Rotate and position until both pegs on connector fit into holes on tube. Connector must point away from end of discharge tube.

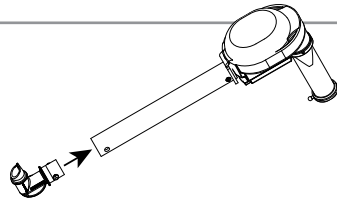

5 SELECT DISCHARGE FITTING

CONSISTENCY OF
WHAT YOU DISPENSE

SUGGESTED
FITTING SIZE

THIN (hot sauce)..... SMALL
THICK (ketchup or mustard)..... MEDIUM
THICKER (relish or tartar sauce)..... LARGE

Fittings are marked small, medium or large on bottom.

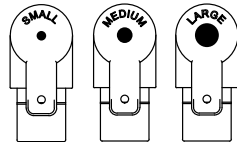

6 INSERT DISCHARGE FITTING

into pump housing discharge tube.

Place loop of fitting around peg on end of discharge tube to secure.

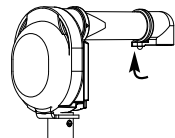
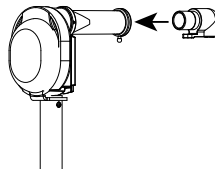

SETUP



PRACTICE SAFETY.

WASH ALL PARTS PROPERLY BEFORE USE. See page 11.

1 ATTACH POUCH TO PUMP

Firmly press piercing connector into center of pouch fitment.

An audible click indicates a secure connection.

TIP: Prime the pump. Push the dome to draw food up towards the discharge tube.

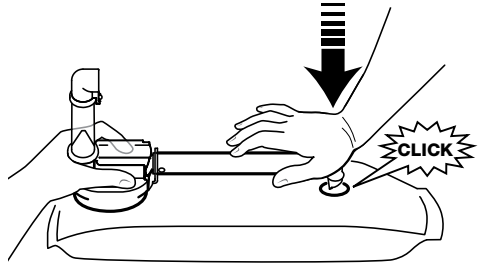

2 INSTALL PUMP

Slide pouch and pump into pouch support within shroud.

Align pump guides into slots in shroud.

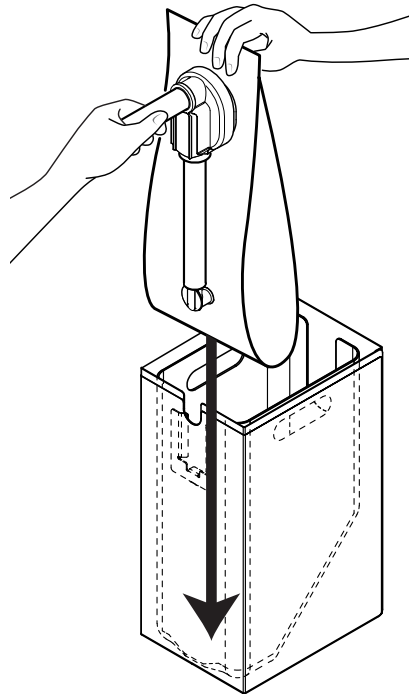

3 PLACE LID ON TOP

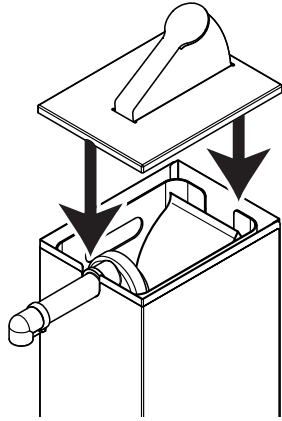

4 PRIME PUMP

Press lever several times until you see product in discharge tube.

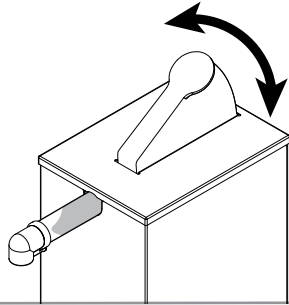

PORTION CONTROL

THE LID IS SET TO DELIVER 1 OZ PORTIONS.

If lid reassembly is needed,
or to specify a different portion size:

One hinge pin attaches lever to lid.

Second hinge pin attaches roller to lever.
(Controls portion dispensed.)

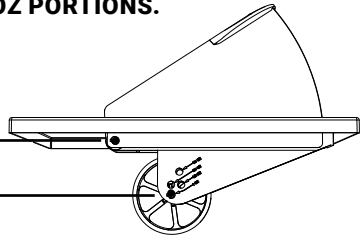

Install hinge pin through center
roller hole and desired portion
hole on lever.

Pin snaps into place.

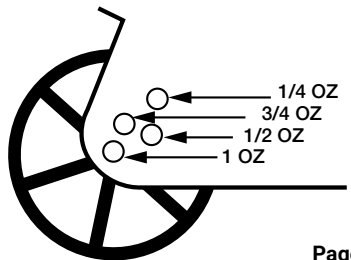
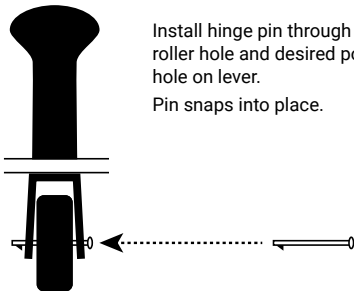

TAKE-DOWN & DISASSEMBLY

1 REMOVE LID

2 REMOVE PUMP & POUCH

3 DETACH PUMP FROM POUCH

4 FLUSH & RINSE PUMP

Place lower end of pump into container of hot water. Pump until all remaining product is expelled and only water flows from discharge tube.

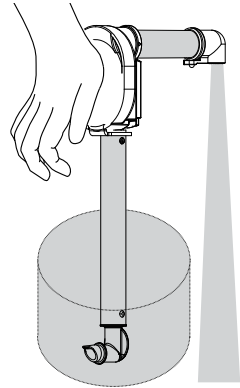

5 DISASSEMBLE

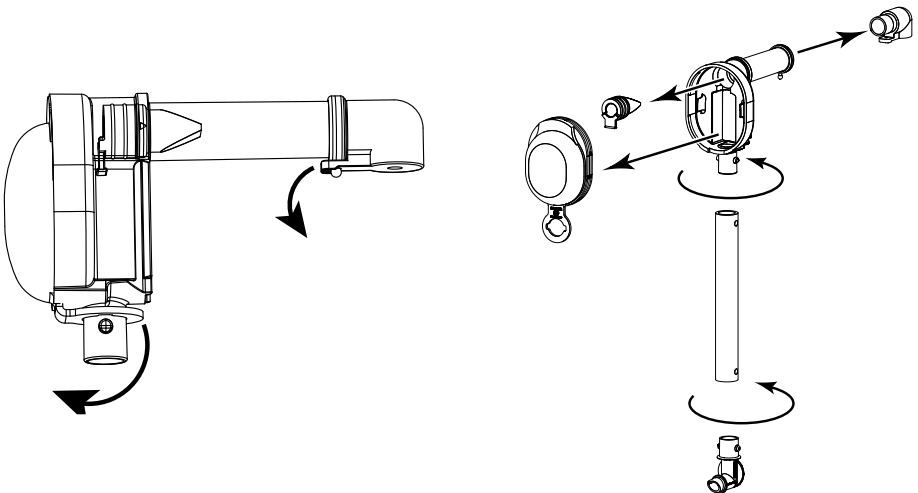

CLEANING

1 CLEAN

After disassembling, clean all washable parts with soap and hot water.

2 RINSE

fully with clear water.

3 SANITIZE

all parts according to local sanitization requirements. All parts in contact with food must be sanitized.

4 AIR DRY

all parts fully.



YES!

Use dishwashing soap and hot water

- External surfaces may be wiped clean with a clean damp cloth.
- Glass and surface cleaners approved for use in food contact areas may be used.
- Do not use abrasive, caustic or ammonia based cleansers.
- Do not use metal scrapers or cleaning pads that could scratch surfaces.

CARE OF STAINLESS STEEL

This unit is constructed with stainless steel— one of the best materials for food serving and storage.

If you notice corrosion beginning on any stainless steel surface, you may need to change the cleansing agent, sanitizing agent, or the cleaning procedures you are using.

- A mildly abrasive nylon or brass brush may be used to remove any stubborn food or mineral deposits on interior surfaces of unit.
- Fully rinsing and drying all parts can help prevent corrosion. Elements and minerals in tap water can accumulate on stainless steel parts and create corrosion.
- Do not use products containing acids, alkalines, chlorine, or salt. These agents can corrode stainless steel.

TROUBLESHOOTING

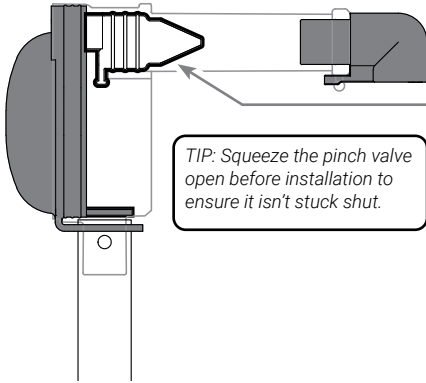

DIFFICULT TO ATTACH PARTS?

- Wet parts with clean water to help fit.

PRODUCT DOESN'T PUMP?

- Ensure pinch valve is inserted in housing.
- Ensure connector is snapped fully in place to fitment in pouch.
- Ensure pump is properly attached to pouch.
- Clean pump thoroughly.
- Ensure pump is properly installed into retaining slots inside front wall of shroud.

DOMES POPS OFF?

- Clean thoroughly. Food residue could prevent a tight seal between dome and housing.
- Ensure dome edges are flush with housing.

SERVER PRODUCTS LIMITED WARRANTY

2 YEAR
WARRANTY

This Server product is backed by a two-year limited warranty against defects in materials and workmanship. See Server-Products.com for details.

NEED HELP?

Server Products Inc.

3601 Pleasant Hill Road
Richfield, WI 53076 USA

Chat with us!

spsales@server-products.com

262.628.5600 | 800.558.8722

Please be prepared with your **Model, P/N** and **Series** located on the lid or base of the unit.

Example:

MODEL		SERIES
XXXX		##X ##X
P/N		
#####		

SERVER
INTELLIGENT BY DESIGN™