

DENON

AV SURROUND RECEIVER

AVR-2803/983

OPERATING INSTRUCTIONS

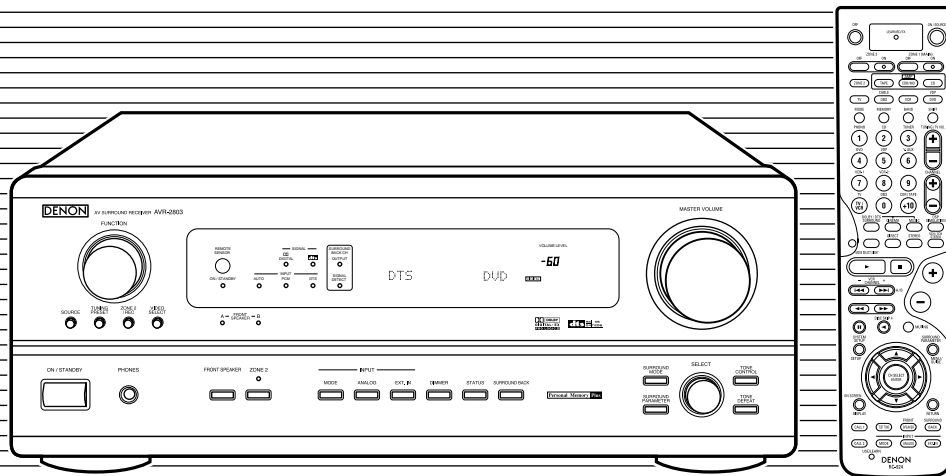

- We greatly appreciate your purchase of the AVR-2803/983.
- To be sure you take maximum advantage of all the features the AVR-2803/983 has to offer, read these instructions carefully and use the set properly. Be sure to keep this manual for future reference, should any questions or problems arise.

“SERIAL NO. _____
PLEASE RECORD UNIT SERIAL NUMBER ATTACHED TO THE REAR OF THE
CABINET FOR FUTURE REFERENCE”

SAFETY PRECAUTIONS

WARNING:

TO PREVENT FIRE OR SHOCK HAZARD, DO NOT EXPOSE THIS APPLIANCE TO RAIN OR MOISTURE.



CAUTION
RISK OF ELECTRIC SHOCK
DO NOT OPEN



CAUTION: TO REDUCE THE RISK OF ELECTRIC SHOCK, DO NOT REMOVE COVER (OR BACK). NO USER-SERVICEABLE PARTS INSIDE. REFER SERVICING TO QUALIFIED SERVICE PERSONNEL.



The lightning flash with arrowhead symbol, within an equilateral triangle, is intended to alert the user to the presence of uninsulated "dangerous voltage" within the product's enclosure that may be of sufficient magnitude to constitute a risk of electric shock to persons.



The exclamation point within an equilateral triangle is intended to alert the user to the presence of important operating and maintenance (servicing) instructions in the literature accompanying the appliance.

CAUTION

TO PREVENT ELECTRIC SHOCK, MATCH WIDE BLADE OF PLUG TO WIDE SLOT, FULLY INSERT.

ATTENTION

POUR ÉVITER LES CHOCS ÉLECTRIQUES, INTRODUIRE LA LAME LA PLUS LARGE DE LA FICHE DANS LA BORNE CORRESPONDANTE DE LA PRISE ET POUSSER JUSQU' AU FOND.

This device complies with Part 15 of the FCC Rules. Operation is subject to the following two conditions: (1) This device may not cause harmful interference, and (2) this device must accept any interference received, including interference that may cause undesired operation.

This Class B digital apparatus meets all requirements of the Canadian Interference-Causing Equipment Regulations.

Cet appareil numérique de la classe B respecte toutes les exigences du Règlement sur le matériel brouilleur du Canada.

NOTE ON USE / OBSERVATIONS RELATIVES A L'UTILISATION

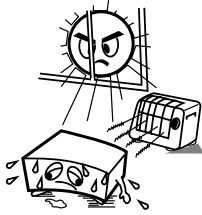

- Avoid high temperatures. Allow for sufficient heat dispersion when installed on a rack.
- Éviter des températures élevées. Tenir compte d'une dispersion de chaleur suffisante lors de l'installation sur une étagère.

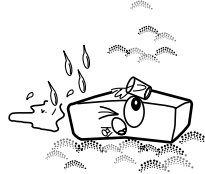

- Keep the set free from moisture, water, and dust.
- Protéger l'appareil contre l'humidité, l'eau et la poussière.



- Do not let foreign objects in the set.
- Ne pas laisser des objets étrangers dans l'appareil.

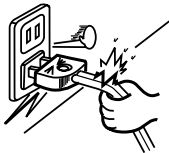

- Handle the power cord carefully. Hold the plug when unplugging the cord.
- Manipuler le cordon d'alimentation avec précaution. Tenir la prise lors du débranchement du cordon.

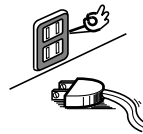

- Unplug the power cord when not using the set for long periods of time.
- Débrancher le cordon d'alimentation lorsque l'appareil n'est pas utilisé pendant de longues périodes.



- Do not let insecticides, benzene, and thinner come in contact with the set.
- Ne pas mettre en contact des insecticides, du benzène et un diluant avec l'appareil.



* (For sets with ventilation holes)

- Do not obstruct the ventilation holes.
- Ne pas obstruer les trous d'aération.



- Never disassemble or modify the set in any way.
- Ne jamais démonter ou modifier l'appareil d'une manière ou d'une autre.

SAFETY INSTRUCTIONS

1. Read Instructions – All the safety and operating instructions should be read before the product is operated.
2. Retain Instructions – The safety and operating instructions should be retained for future reference.
3. Heed Warnings – All warnings on the product and in the operating instructions should be adhered to.
4. Follow Instructions – All operating and use instructions should be followed.
5. Cleaning – Unplug this product from the wall outlet before cleaning. Do not use liquid cleaners or aerosol cleaners.
6. Attachments – Do not use attachments not recommended by the product manufacturer as they may cause hazards.
7. Water and Moisture – Do not use this product near water – for example, near a bath tub, wash bowl, kitchen sink, or laundry tub; in a wet basement; or near a swimming pool; and the like.
8. Accessories – Do not place this product on an unstable cart, stand, tripod, bracket, or table. The product may fall, causing serious injury to a child or adult, and serious damage to the product. Use only with a cart, stand, tripod, bracket, or table recommended by the manufacturer, or sold with the product. Any mounting of the product should follow the manufacturer's instructions, and should use a mounting accessory recommended by the manufacturer.
9. A product and cart combination should be moved with care. Quick stops, excessive force, and uneven surfaces may cause the product and cart combination to overturn.
10. Ventilation – Slots and openings in the cabinet are provided for ventilation and to ensure reliable operation of the product and to protect it from overheating, and these openings must not be blocked or covered. The openings should never be blocked by placing the product on a bed, sofa, rug, or other similar surface. This product should not be placed in a built-in installation such as a bookcase or rack unless proper ventilation is provided or the manufacturer's instructions have been adhered to.
11. Power Sources – This product should be operated only from the type of power source indicated on the marking label. If you are not sure of the type of power supply to your home, consult your product dealer or local power company. For products intended to operate from battery power, or other sources, refer to the operating instructions.
12. Grounding or Polarization – This product may be equipped with a polarized alternating-current line plug (a plug having one blade wider than the other). This plug will fit into the power outlet only one way. This is a safety feature. If you are unable to insert the plug fully into the outlet, try reversing the plug. If the plug should still fail to fit, contact your electrician to replace your obsolete outlet. Do not defeat the safety purpose of the polarized plug.



13. Power-Cord Protection – Power-supply cords should be routed so that they are not likely to be walked on or pinched by items placed upon or against them, paying particular attention to cords at plugs, convenience receptacles, and the point where they exit from the product.
15. Outdoor Antenna Grounding – If an outside antenna or cable system is connected to the product, be sure the antenna or cable system is grounded so as to provide some protection against voltage surges and built-up static charges. Article 810 of the National Electrical Code, ANSI/NFPA 70, provides information with regard to proper grounding of the mast and supporting structure, grounding of the lead-in wire to an antenna discharge unit, size of grounding conductors, location of antenna-discharge unit, connection to grounding electrodes, and requirements for the grounding electrode. See Figure A.
16. Lightning – For added protection for this product during a lightning storm, or when it is left unattended and unused for long periods of time, unplug it from the wall outlet and disconnect the antenna or cable system. This will prevent damage to the product due to lightning and power-line surges.
17. Power Lines – An outside antenna system should not be located in the vicinity of overhead power lines or other electric light or power circuits, or where it can fall into such power lines or circuits. When installing an outside antenna system, extreme care should be taken to keep from touching such power lines or circuits as contact with them might be fatal.
18. Overloading – Do not overload wall outlets, extension cords, or integral convenience receptacles as this can result in a risk of fire or electric shock.
19. Object and Liquid Entry – Never push objects of any kind into this product through openings as they may touch dangerous voltage points or short-out parts that could result in a fire or electric shock. Never spill liquid of any kind on the product.
20. Servicing – Do not attempt to service this product yourself as opening or removing covers may expose you to dangerous voltage or other hazards. Refer all servicing to qualified service personnel.
21. Damage Requiring Service – Unplug this product from the wall outlet and refer servicing to qualified service personnel under the following conditions:
 - a) When the power-supply cord or plug is damaged,
 - b) If liquid has been spilled, or objects have fallen into the product,
 - c) If the product has been exposed to rain or water,
 - d) If the product does not operate normally by following the operating instructions. Adjust only those controls that are covered by the operating instructions as an improper adjustment of other controls may result in damage and will often require extensive work by a qualified technician to restore the product to its normal operation,
 - e) If the product has been dropped or damaged in any way, and
 - f) When the product exhibits a distinct change in performance – this indicates a need for service.
22. Replacement Parts – When replacement parts are required, be sure the service technician has used replacement parts specified by the manufacturer or have the same characteristics as the original part. Unauthorized substitutions may result in fire, electric shock, or other hazards.
23. Safety Check – Upon completion of any service or repairs to this product, ask the service technician to perform safety checks to determine that the product is in proper operating condition.
24. Wall or Ceiling Mounting – The product should be mounted to a wall or ceiling only as recommended by the manufacturer.
25. Heat – The product should be situated away from heat sources such as radiators, heat registers, stoves, or other products (including amplifiers) that produce heat.

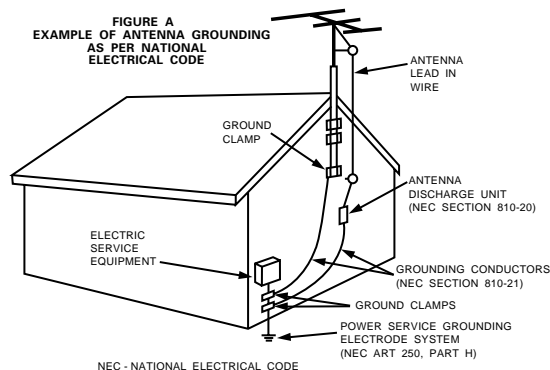

■ INTRODUCTION

Thank you for choosing the DENON AVR-2803/983 Digital A / V Surround Receiver. This remarkable component has been engineered to provide superb surround sound listening with home theater sources such as DVD, as well as providing outstanding high fidelity reproduction of your favorite music sources.

As this product is provided with an immense array of features, we recommend that before you begin hookup and operation that you review the contents of this manual before proceeding.

TABLE OF CONTENTS

1 Before Using4	10 Surround49~54
2 Cautions on Installation4	11 DSP Surround Simulation55~60
3 Cautions on Handling5	12 Listening to the Radio.....61~63
4 Features5	13 Last Function Memory.....63
5 Connections6~13	14 Initialization of the Microprocessor63
6 Part Names and Functions.....14, 15	15 Troubleshooting.....64
7 Setting up the system16~30	16 Additional Information.....65~74
8 Remote Control Unit.....31~40	17 Specifications75
9 Operation41~48	

■ ACCESSORIES

Check that the following parts are included in addition to the main unit:

- | | | | |
|--------------------------------|---|------------------------------|--------------------------------------|
| ① Operating instructions.....1 | ② Warranty (for North America model only).....1 | ③ Service station list.....1 | ④ Remote control unit (RC-924).....1 |
| ⑤ R6P/AA batteries3 | ⑥ AM loop antenna.....1 | ⑦ FM indoor antenna...1 | |

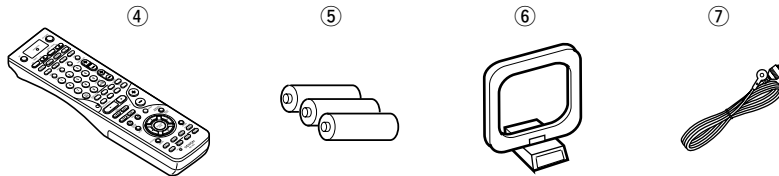

1 BEFORE USING

Pay attention to the following before using this unit:

• Moving the set

To prevent short circuits or damaged wires in the connection cords, always unplug the power cord and disconnect the connection cords between all other audio components when moving the set.

• Before turning the power switch on

Check once again that all connections are proper and that there are not problems with the connection cords. Always set the power switch to the standby position before connecting and disconnecting connection cords.

• Store this instructions in a safe place.

After reading, store this instructions along with the warranty in a safe place.

• Note that the illustrations in this instructions may differ from the actual set for explanation purposes.

2 CAUTIONS ON INSTALLATION

Noise or disturbance of the picture may be generated if this unit or any other electronic equipment using microprocessors is used near a tuner or TV.

If this happens, take the following steps:

- Install this unit as far as possible from the tuner or TV.
- Set the antenna wires from the tuner or TV away from this unit's power cord and input/output connection cords.
- Noise or disturbance tends to occur particularly when using indoor antennas or 300 Ω/ohms feeder wires. **We recommend using outdoor antennas and 75 Ω/ohms coaxial cables.**

For heat dispersal, leave at least 4 inch/10 cm of space between the top, back and sides of this unit and the wall or other components.

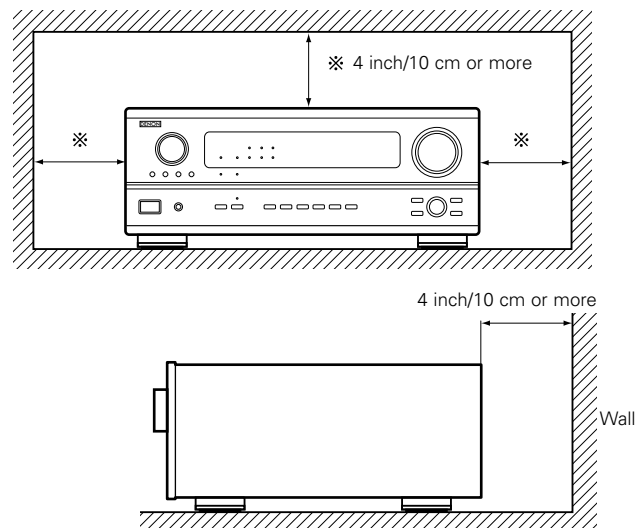

3 CAUTIONS ON HANDLING

- **Switching the input function when input jacks are not connected**

A clicking noise may be produced if the input function is switched when nothing is connected to the input jacks. If this happens, either turn down the MASTER VOLUME control or connect components to the input jacks.

- **Muting of PRE OUT jacks, HEADPHONE jack and SPEAKER terminals**

The PRE OUT jacks, HEADPHONE jack and SPEAKER terminals include a muting circuit. Because of this, the output signals are greatly reduced for several seconds after the power switch is turned on or input function, surround mode or any other-set-up is changed. If the volume is turned up during this time, the output will be very high after the muting circuit stops functioning. Always wait until the muting circuit turns off before adjusting the volume.

- **Whenever the power switch is in the STANDBY state, the apparatus is still connected on AC line voltage. Please be sure to unplug the cord when you leave home for, say, a vacation.**

4 FEATURES

1. Digital Surround Sound Decoding

Featuring 32 bit high speed DSP, operating entirely in digital domain, surround sound from digital sources such as DVD, LD, DTV and satellite are faithfully re-created.

2. DTS 96/24 compatibility

The AVR-2803/983 can be decoded with sources recorded in DTS 96/24, a new multi-channel digital signal format developed by Digital Theater Systems Inc.

DTS 96/24 sources can be played in the multi-channel mode on the AVR-2803/983 with high sound quality of 96 kHz/24 bits or 88.2 kHz/24 bits.

3. DTS-ES Extended Surround and DTS Neo:6

The AVR-2803/983 can be decoded with DTS-ES Extended Surround, a new multi-channel format developed by Digital Theater Systems Inc. The AVR-2803/983 can be also decoded with DTS Neo:6, a surround mode allowing 6.1-channel playback of regular stereo sources.

4. DTS (Digital Theater Systems)

DTS provides up to 5.1 channels of wide-range, high fidelity surround sound, from sources such as laser disc, DVD and specially-encoded music discs.

5. Dolby Digital

Using advanced digital processing algorithms, Dolby Digital provides up to 5.1 channels of wide-range, high fidelity surround sound. Dolby Digital is the default digital audio delivery system for DVD and North American DTV.

6. Dolby Pro Logic II decoder

Dolby Pro Logic II is a new format for playing multi-channel audio signals that offers improvements over conventional Dolby Pro Logic. It can be used to decode not only sources recorded in Dolby Surround but also regular stereo sources into five channels (front left/right, center and surround left/right). In addition, various parameters can be set according to the type of source and the contents, so you can adjust the sound field with greater precision.

7. Dolby Digital EX decoder system

Dolby Digital EX is a 6.1-channel surround format proposed by Dolby Laboratories that allows users to enjoy in their homes the "DOLBY DIGITAL SURROUND EX" audio format jointly developed by Dolby Laboratories and Lucas Films and first used for the movie "Star Wars Episode 1 – Phantom Menace".

The 6.1 channels of sound, including surround back channels, provide improved sound positioning and expression of space.

8. Wide screen mode for a 7.1-channel sound even with 5.1-channel sources

DENON has developed a wide screen mode with a new design which recreates the effects of the multi surround speakers in movie theaters. The result is 7.1-channel sound taking full advantage of surround back speakers, even with Dolby Pro Logic or Dolby Digital/DTS 5.1-channel signals.

9. Multi Zone Music Entertainment System

Multi Source Function:

This unit's Multi Source function lets you select different audio sources for listening. Different sources can thus be enjoyed in the main room (MAIN) and the subroom (ZONE 2) simultaneously.

10. Component Video Switching

In addition to composite video and "S" video switching, the AVR-2803/983 provides 2 sets of component video (Y, Pb/Cb, Pr/Cr) inputs, and one set of component video outputs to the television, for superior picture quality.

11. Video Select Function

Allow you to watch one source (visual) while listening to another source (audio).

12. Future Sound Format Upgrade Capability via Eight Channel Inputs & Outputs

For future multi-channel audio format(s), the AVR-2803/983 is provided with 7.1 channel (seven main channels, plus one low frequency effects channel) inputs, along with a full set of 7.1 channel pre-amp outputs, controlled by the 8 channel master volume control. This assures future upgrade possibilities for any future multi-channel sound format.

5 CONNECTIONS

- Do not plug in the AC cord until all connections have been completed.
- Be sure to connect the left and right channels properly (left with left, right with right).
- Insert the plugs securely. Incomplete connections will result in the generation of noise.
- **Use the AC OUTLETS for audio equipment only. Do not use them for hair driers, etc.**

- Note that binding pin plug cords together with AC cords or placing them near a power transformer will result in generating hum or other noise.
- Noise or humming may be generated if a connected audio equipment is used independently without turning the power of this unit on. If this happens, turn on the power of the this unit.

Connecting the audio components

- When making connections, also refer to the operating instructions of the other components.
The power to these outlets is turned on and off when the power is switched between on and standby from the remote control unit or power switch.

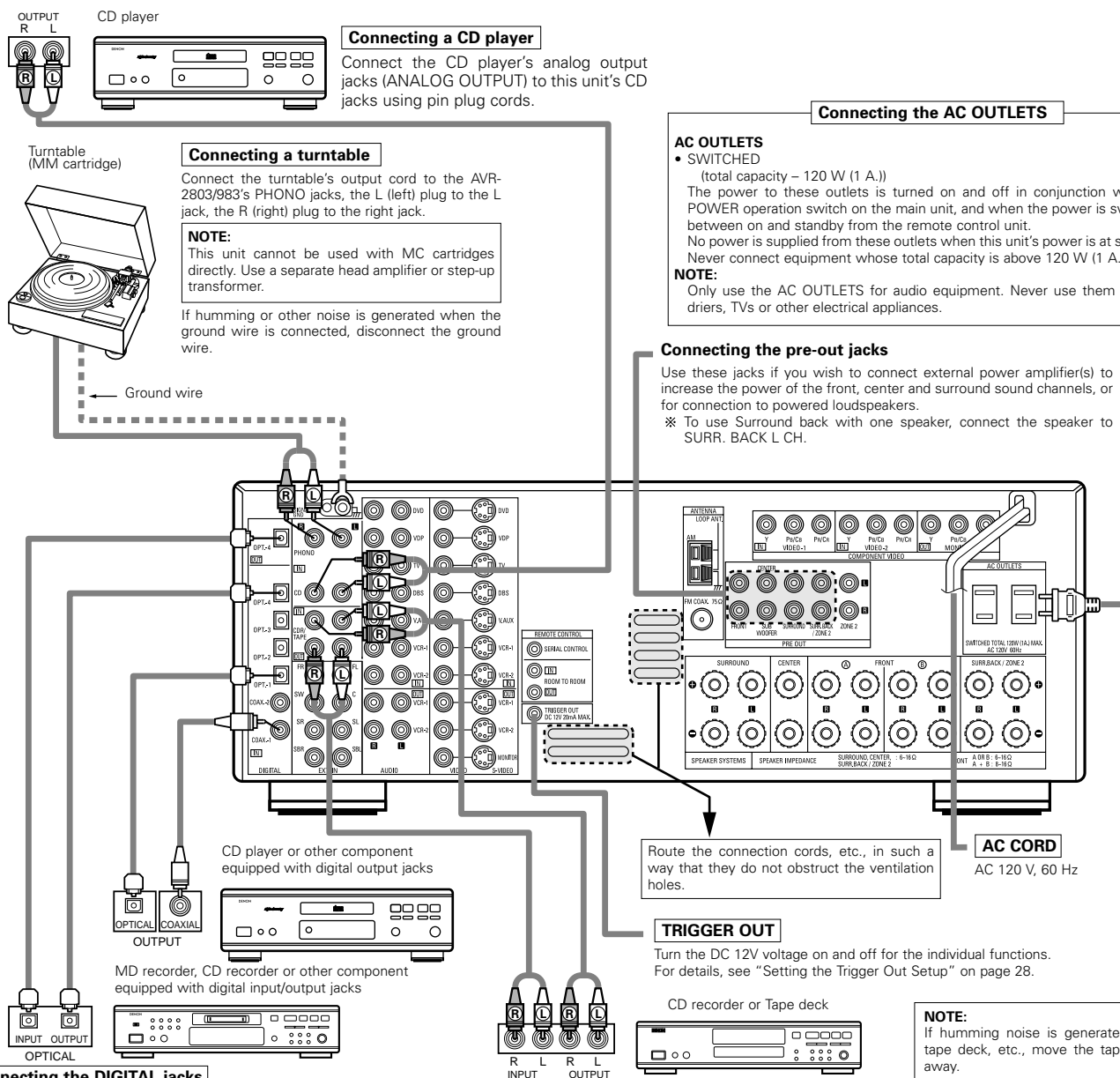

Connecting the video components

- To connect the video signal, connect using a 75 Ω/ohms video signal cable cord. Using an improper cable can result in a drop in video quality.
- When making connections, also refer to the operating instructions of the other components.

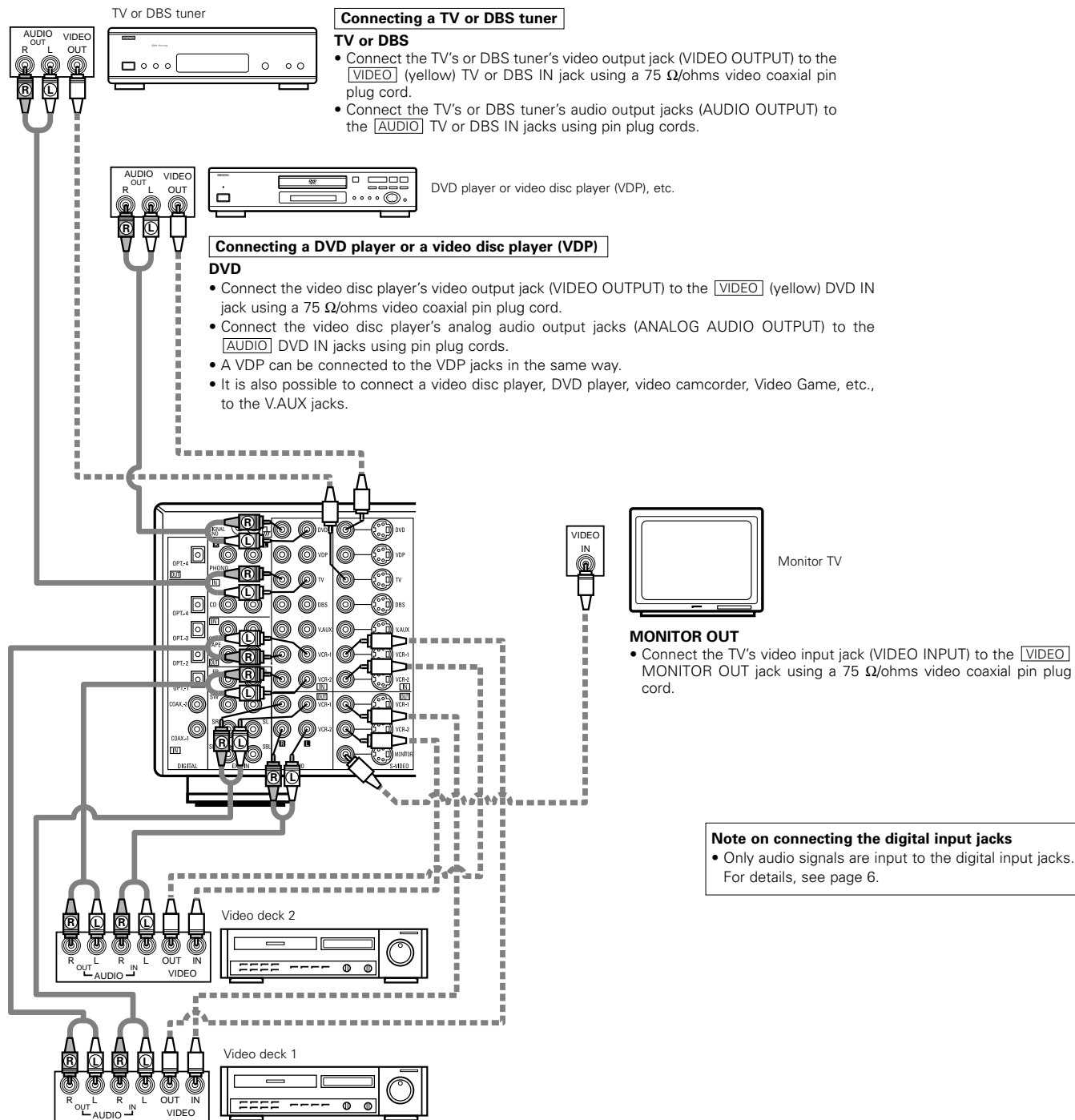

Connecting a video decks

- There are two sets of video deck (VCR) jacks, so two video decks can be connected for simultaneous recording or video copying.

Video input/output connections:

- Connect the video deck's video output jack (VIDEO OUT) to the **VIDEO** (yellow) VCR-1 IN jack, and the video deck's video input jack (VIDEO IN) to the **VIDEO** (yellow) VCR-1 OUT jack using 75 Ω/ohms video coaxial pin plug cords.

Connecting the audio output jacks

- Connect the video deck's audio output jacks (AUDIO OUT) to the **AUDIO** VCR-1 IN jacks, and the video deck's audio input jacks (AUDIO IN) to the **AUDIO** VCR-1 OUT jacks using pin plug cords.

※ Connect the second video deck to the VCR-2 jacks in the same way.

Connecting the video components equipped with S-Video jacks

- When making connections, also refer to the operating instructions of the other components.

• A note on the S input jacks

The input selectors for the S inputs and Video inputs work in conjunction with each other.

• Precaution when using S-jacks

This unit's S-jacks (input and output) and video pin jacks (input and output) have independent circuit structures, so that video signals input from the S-jacks are only output from the S-jack outputs and video signals input from the pin jacks are only output from the pin jack outputs.

When connecting this unit with equipment that is equipped with S-jacks, keep the above point in mind and make connections according to the equipment's instruction manuals.

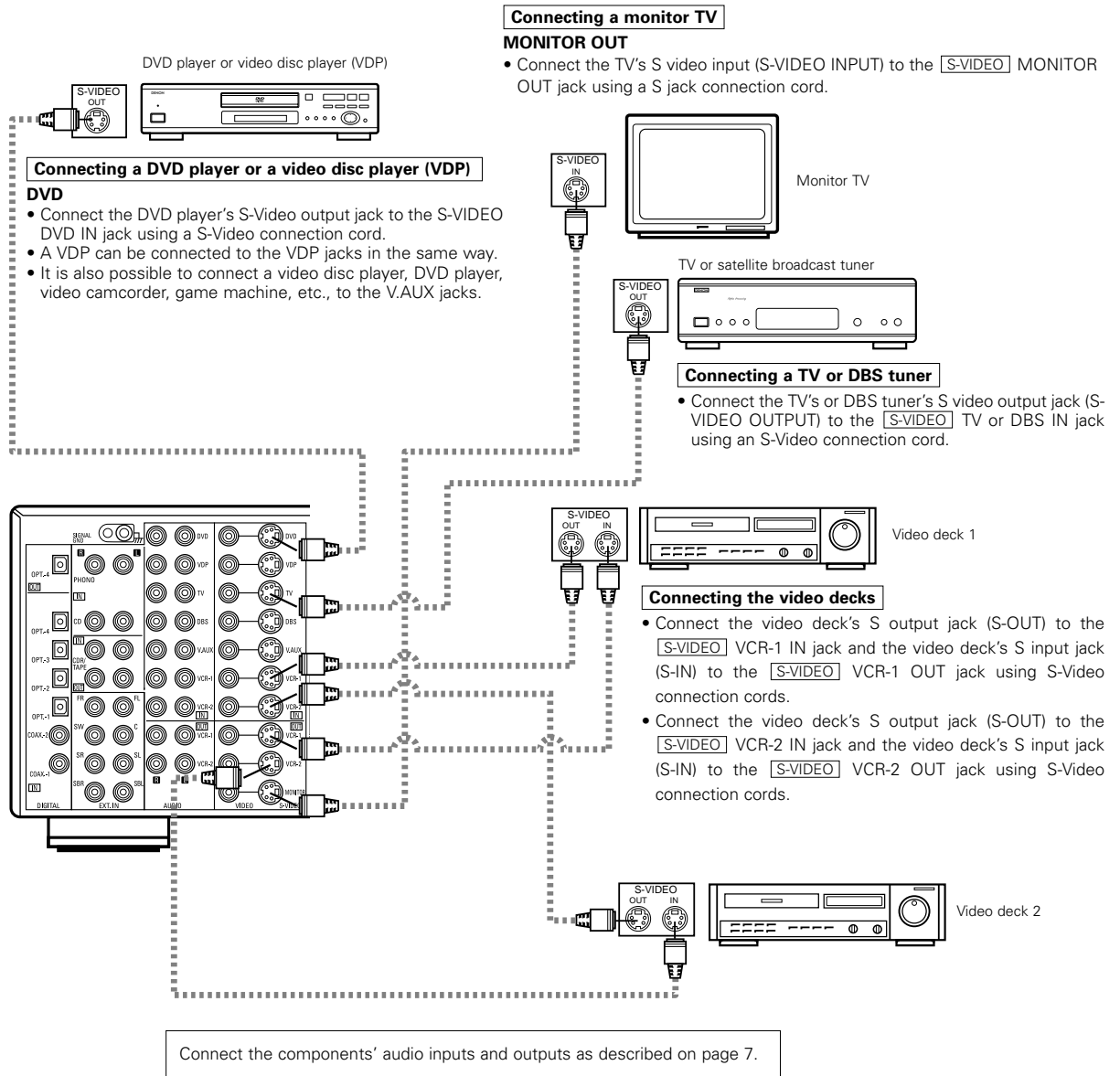

Connecting the video component equipped with Color Difference (Component - Y, P_R/C_R, P_B/C_B) Video jacks

- When making connections, also refer to the operating instructions of the other components.
- The signals input to the color difference (component) video jacks are not output to the VIDEO output jack (yellow) or the S-Video output jack.
- Some video sources with component video outputs are labeled Y, C_B, C_R, or Y, P_b, P_r, or Y, R-Y, B-Y. These terms all refer to component video color difference output.
- The function assigned to the component video input can be changed at the system setup. For details, see “Setting the video In Assignment” on page 24.
- The AVR-2803’s on-screen display signals are not output from the color difference (component) video output jacks (MONITOR OUT).

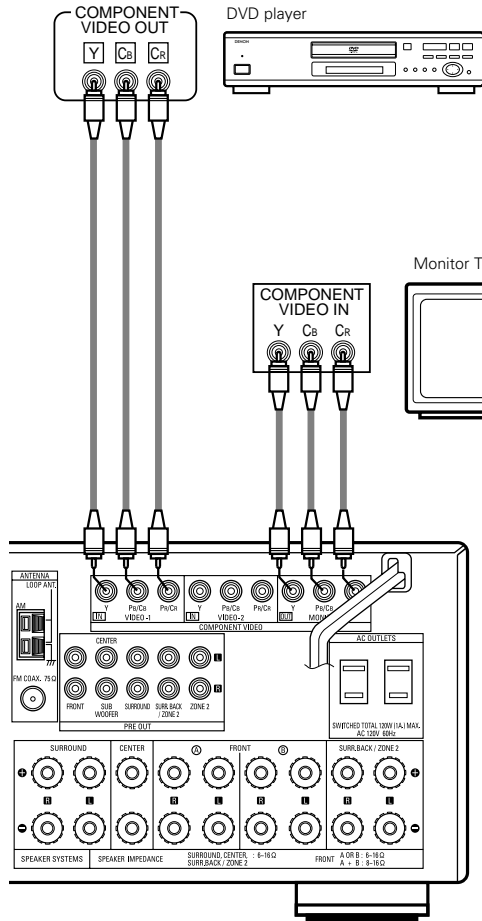

Connecting a DVD player

DVD IN jacks

- Connect the DVD player’s color difference (component) video output jacks (COMPONENT VIDEO OUTPUT) to the COMPONENT VIDEO-1 IN jack using 75 Ω/ohms coaxial video pin-plug cords.
- In the same way, another video source with component video outputs such as a TV/DBS tuner, etc., can be connected to the VIDEO-2 color difference (component) video jacks.

Connecting a monitor TV

MONITOR OUT jack

- Connect the TV’s color difference (component) video input jacks (COMPONENT VIDEO INPUT) to the COMPONENT MONITOR OUT jack using 75 Ω/ohms coaxial video pin-plug cords.

• The color difference input jacks may be indicated differently on some TVs, monitors or video components (“C_R, C_B and Y”, “R-Y, B-Y and Y”, “P_r, P_b and Y”, etc.). For details, carefully read the operating instructions included with the TV or other component.

Connecting the external input (EXT. IN) jacks

- These jacks are for inputting multi-channel audio signals from an outboard decoder, or a component with a different type of multi-channel decoder, such as a DVD Audio player, a multi-channel SACD player, or other future multi-channel sound format decoder.
- When making connections, also refer to the operating instructions of the other components.

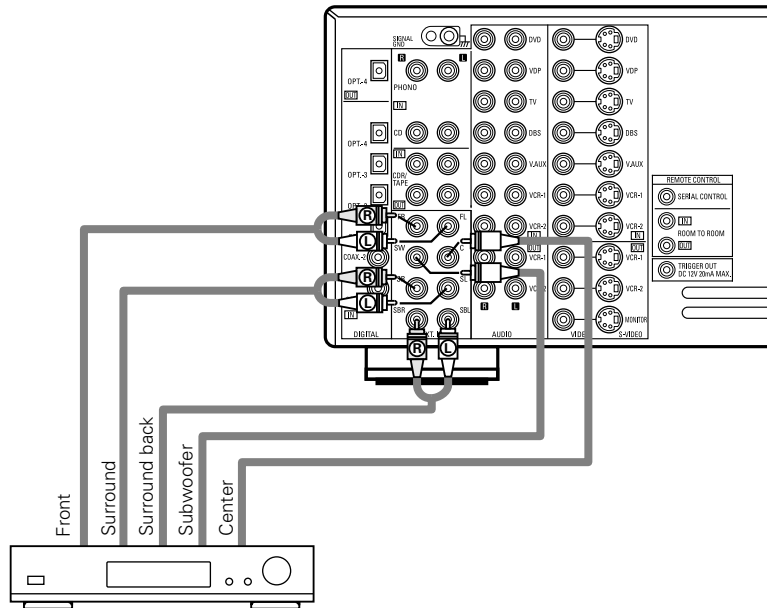

Decoder with 8- or 6-channel analog output

※ For instructions on playback using the external input (EXT. IN) jacks, see page 44.

Connecting the ZONE 2 jacks

- If another pre-main (integrated) amplifier or power amplifier is connected, the ZONE 2 jacks can be used to play a different program source in ZONE 2 the same time. (See page 48)

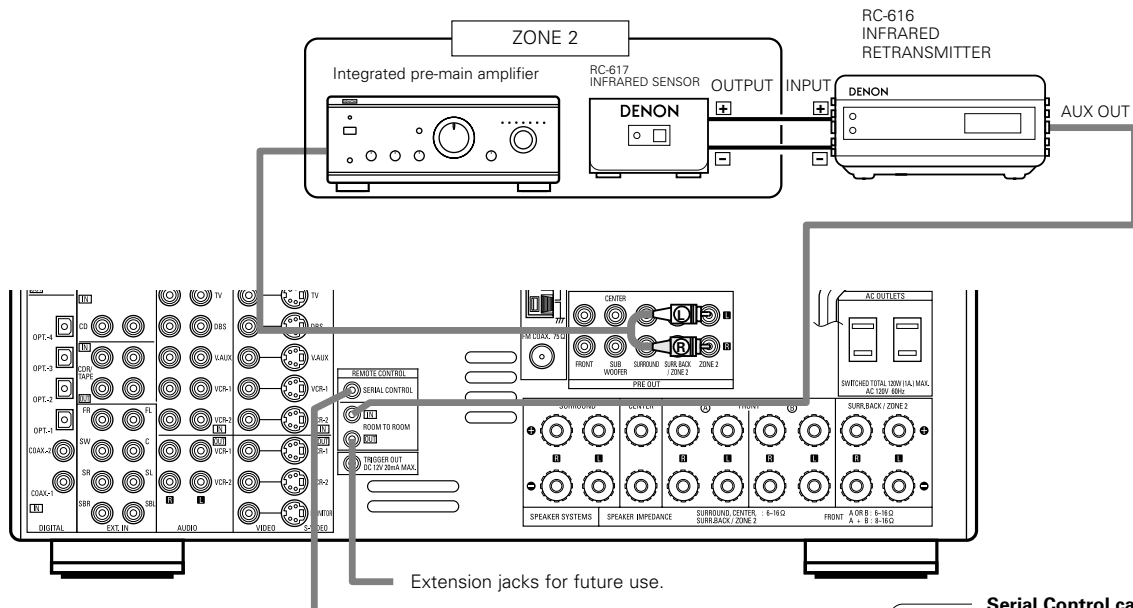

SERIAL CONTROL terminal

- Connect when using an external controller.
- Use an adapter cable (sold separately) as shown on the diagram at the right to connect the external controller.

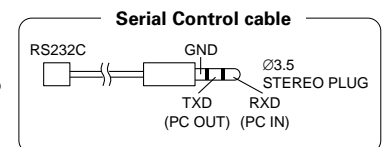

※ For instructions on operations using the ZONE 2 jacks, see page 47, 48.

Speaker system connections

- Connect the speaker terminals with the speakers making sure that like polarities are matched (⊕ with ⊕, ⊖ with ⊖). Mismatching of polarities will result in weak central sound, unclear orientation of the various instruments, and the sense of direction of the stereo being impaired.
- When making connections, take care that none of the individual conductors of the speaker cord come in contact with adjacent terminals, with other speaker cord conductors, or with the rear panel.

NOTE:
NEVER touch the speaker terminals when the power is on.
Doing so could result in electric shocks.

Speaker Impedance

- Speakers with an impedance of from 6 to 16 Ω/ohms can be connected for use as front and center speakers.
- Speakers with an impedance of 6 to 16 Ω/ohms can be connected for use as surround speakers.
- Be careful when using two pairs of front speakers (A + B) at the same time, since use of speakers with an impedance of less than 8 Ω/ohms will lead to damage.
- The protector circuit may be activated if the set is played for long periods of time at high volumes when speakers with an impedance lower than the specified impedance are connected.

Connection the speaker terminals

1. Loosen by turning counterclockwise

2. Insert the cord.

3. Tighten by turning clockwise.

Either tightly twist or terminate the core wires.

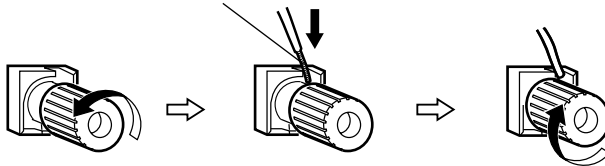

Connecting banana plugs

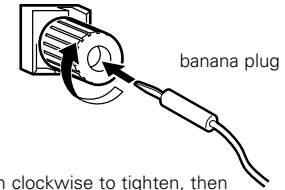

Turn clockwise to tighten, then insert the banana plug.

Connections

- When making connections, also refer to the operating instructions of the other components.

Connection jack for subwoofer with built-in amplifier (super woofer), etc.

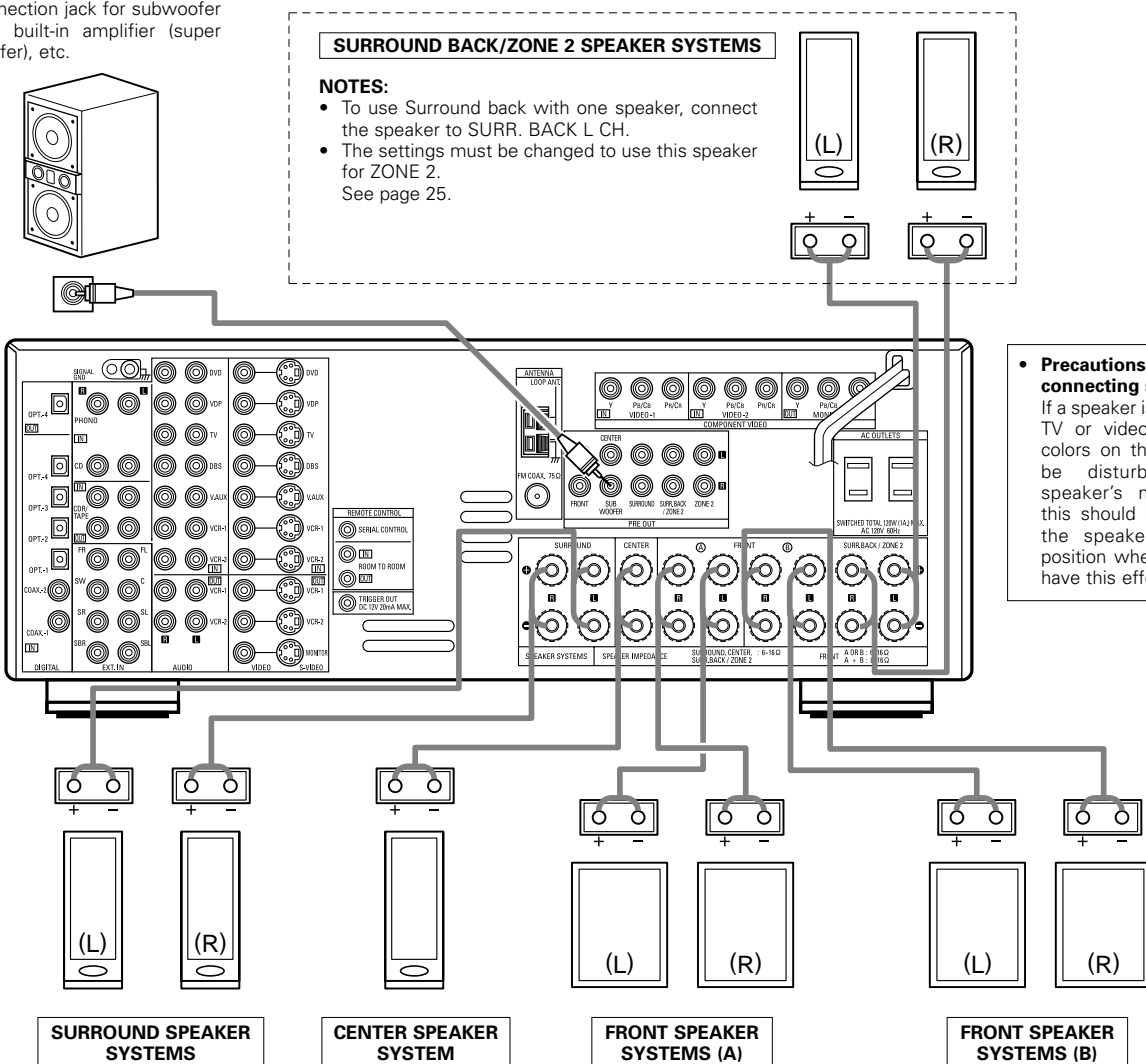
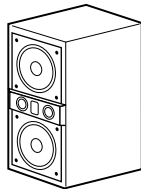

Protector circuit

- This unit is equipped with a high-speed protection circuit. The purpose of this circuit is to protect the speakers under circumstances such as when the output of the power amplifier is inadvertently short-circuited and a large current flows, when the temperature surrounding the unit becomes unusually high, or when the unit is used at high output over a long period which results in an extreme temperature rise.

When the protection circuit is activated, the speaker output is cut off and the power supply indicator LED flashes. Should this occur, please follow these steps: be sure to switch off the power of this unit, check whether there are any faults with the wiring of the speaker cables or input cables, and wait for the unit to cool down if it is very hot. Improve the ventilation condition around the unit and switch the power back on.

If the protection circuit is activated again even though there are no problems with the wiring or the ventilation around the unit, switch off the power and contact a DENON service center.

Note on speaker impedance

- The protector circuit may be activated if the set is played for long periods of time at high volumes when speakers with an impedance lower than the specified impedance (for example speakers with an impedance of lower than 4 Ω /ohms) are connected. If the protector circuit is activated, the speaker output is cut off. Turn off the set's power, wait for the set to cool down, improve the ventilation around the set, then turn the power back on.

6 PART NAMES AND FUNCTIONS

Front Panel

- For details on the functions of these parts, refer to the pages given in parentheses ().

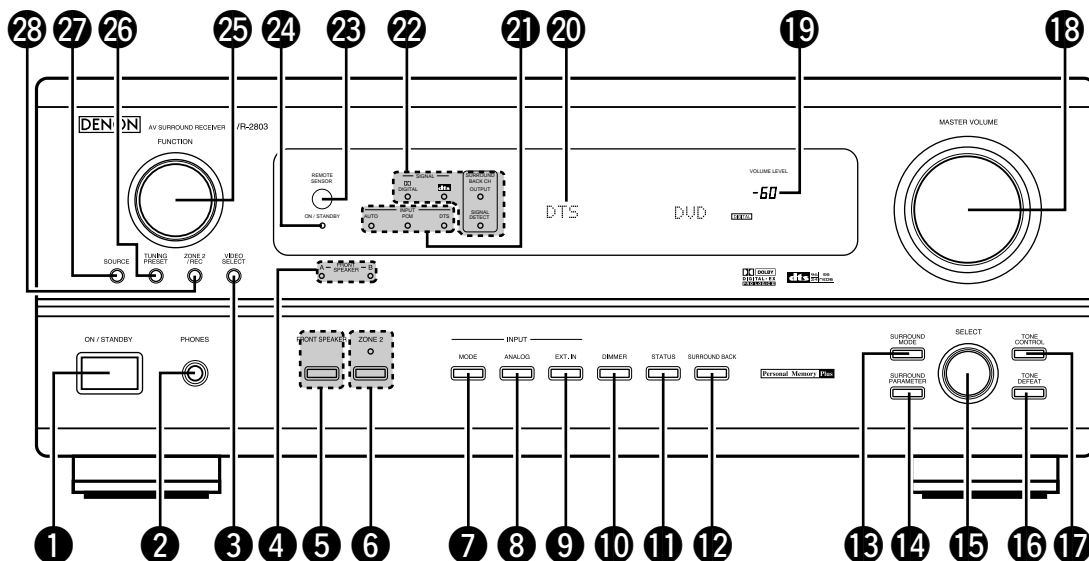

- | | |
|--|---|
| 1 Power ON/STANDBY switch.....(41, 63) | 15 SELECT knob.....(43, 45, 50 ~ 54, 57, 59) |
| 2 Headphones jack (PHONES)(45) | 16 TONE DEFEAT button(45) |
| 3 VIDEO SELECT button(45) | 17 TONE CONTROL button(45, 59) |
| 4 Front speaker system indicators
(FRONT SPEAKER A/B) | 18 MASTER VOLUME control(43) |
| 5 FRONT SPEAKER button(41, 63) | 19 Master volume indicator (VOLUME LEVEL)(43) |
| 6 ZONE 2 button/indicator.....(47, 63) | 20 Display |
| 7 MODE button.....(42, 44, 53) | 21 INPUT mode indicators(43) |
| 8 ANALOG button(42, 44) | 22 SIGNAL indicators(43, 53) |
| 9 EXT. IN button(42, 44) | 23 Remote control sensor (REMOTE SENSOR)(31) |
| 10 DIMMER button(46) | 24 Power indicator(41) |
| 11 STATUS button(46) | 25 FUNCTION knob.....(42, 45 ~ 47, 53, 61, 63) |
| 12 SURROUND BACK button(53) | 26 TUNING PRESET button(63) |
| 13 SURROUND MODE button(43, 50, 52, 53, 57) | 27 SOURCE selector button(42) |
| 14 SURROUND PARAMETER button(51, 52, 54, 57) | 28 ZONE 2/REC button(46, 47) |

Remote control unit

- For details on the functions of these parts, refer to the pages given in parentheses ().

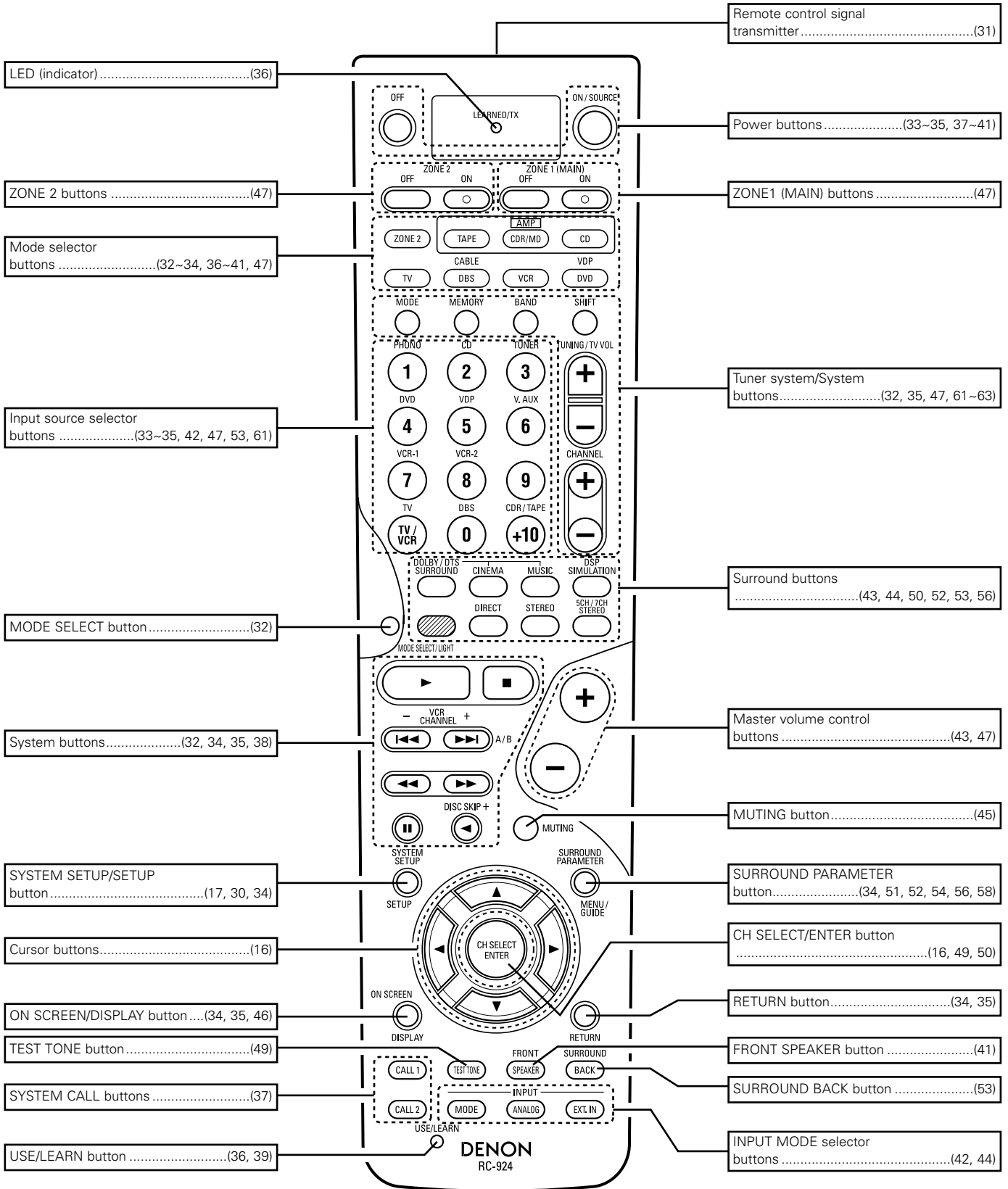

NOTE:

- The shaded button  do not function with the AVR-2803/983. (Nothing happens when they are pressed.)



7 SETTING UP THE SYSTEM

- Once all connections with other AV components have been completed as described in "CONNECTIONS" (see pages 6 to 13), make the various settings described below on the monitor screen using the AVR-2803/983's on-screen display function. These settings are required to set up the listening room's AV system centered around the AVR-2803/983.
- Check that the remote control unit is set to AMP mode (TAPE, CDR/MD or CD).
- The system settings can be reset to the default (factory shipment) settings by initialization of the microprocessor (see page 63).
- Use the following buttons to set up the system:

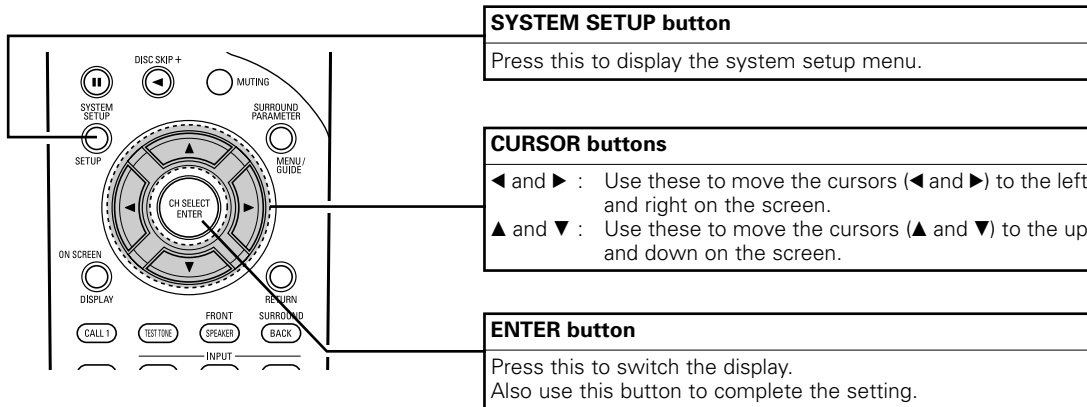

- System setup items and default values (set upon shipment from the factory)

System setup		Default settings											
①	Speaker Configuration	Input the combination of speakers in your system and their corresponding sizes (Small for regular speakers, Large for full-size, full-range) to automatically set the composition of the signals output from the speakers and the frequency response.	Front Sp.	Center Sp.	Sub Woofer	Surround Sp.	Surround Back Sp.						
	Crossover Frequency	Set the frequency (Hz) below which the bass sound of the various speakers is to be output from the subwoofer.	80 Hz										
	Subwoofer mode	This selects the subwoofer speaker for playing deep bass signals.	LFE										
②	Delay Time	This parameter is for optimizing the timing with which the audio signals are produced from the speakers and subwoofer according to the listening position.	Front L & R		Center	Sub Woofer	Surround L & R		SBL & SBR				
			12 ft (3.6 m)		12 ft (3.6 m)	12 ft (3.6 m)	10 ft (3.0 m)		10 ft (3.0 m)				
③	Channel Level	This adjusts the volume of the signals output from the speakers and subwoofer for the different channels in order to obtain optimum effects.	Front L	Front R	Center	Surround L	Surround R	Surround Back L	Surround Back R	Subwoofer			
			0 dB	0 dB	0 dB	0 dB	0 dB	0 dB	0 dB	0 dB			
④	Digital In Assignment	This assigns the digital input jacks for the different input sources.	Input source		CD	DVD	VDP	TV	DBS	V. AUX	VCR-1	VCR-2	TAPE
			Digital Inputs		COAX1	COAX2	OPT1	OPT2	OPT3	OFF	OFF	OFF	OPT4
⑤	Video In Assign	This assigns the color difference (component) video input jacks for the different input sources.	DVD	VDP	TV	DBS	VCR-1	VCR-2	V. AUX	—	—		
			VIDEO1	NONE	NONE	VIDEO2	NONE	NONE	NONE	—	—		
⑥	Dolby Digital Setup	Turn the audio compression on or off when down-mixing Dolby Digital signals.	OFF										
⑦	Zone 2 Control	Power AMP Assignment	Set this to switch the surround back channel's power amplifier for use for zone 2.		Surround Back								
		Zone2 vol. Level	This sets the output level for the zone 2 output jacks.		Variable								
⑧	Ext. In Subwoofer Level	Set the Ext. In Subwoofer terminal playback level.	Subwoofer = +15 dB										
⑨	Auto Surround Mode	Set the Auto surround mode function.	Auto Surround Mode = ON										
⑩	On Screen Display	This sets whether or not to display the on-screen display that appears on the monitor screen when the controls on the remote control unit or main unit are operated.	On Screen Display = ON										
⑪	Trigger Out Setup	Set the Trigger Out output for the different input sources.	PHONO	CD	TUNER	TAPE	DVD	VDP	TV	DBS	VCR-1	VCR-2	V. AUX
			OFF	OFF	OFF	OFF	ON	ON	ON	ON	ON	ON	ON

System setup			Default settings	
12	Auto Tuner Presets	FM stations are received automatically and stored in the memory.	A1 ~ A8	87.5/89.1/98.1/107.9/90.1/90.1/90.1/90.1 MHz
			B1 ~ B8	520/600/1000/1400/1500/1710 kHz, 90.1/90.1 MHz
			C1 ~ C8	90.1 MHz
			D1 ~ D8	90.1 MHz
			E1 ~ E8	90.1 MHz
13	Setup Lock	Set whether or not to lock the system setup settings so that they cannot be changed.	Setup Lock = OFF	

NOTES:

- The on-screen display signals are output with priority to the S-VIDEO MONITOR OUT jack during playback of a video component. For example, if the TV monitor is connected to both the AVR-2803/983's S-Video and video monitor output jacks and signals are input to the AVR-2803/983 from a video source (VDP, etc.) connected to both the S-Video and video input jacks, the on-screen display signals are output with priority to the S-Video monitor output. If you wish to output the signals to the video monitor output jack, do not connect a cord to the S-VIDEO MONITOR OUT jack. (For details, see page 30.)
- The AVR-2803/983's on-screen display function is designed for use with high resolution monitor TVs, so it may be difficult to read small characters on TVs with small screens or low resolutions.
- The setup menu is not displayed when headphones are being used.

• Speaker system layout

Basic system layout

- The following is an example of the basic layout for a system consisting of eight speaker systems and a television monitor:

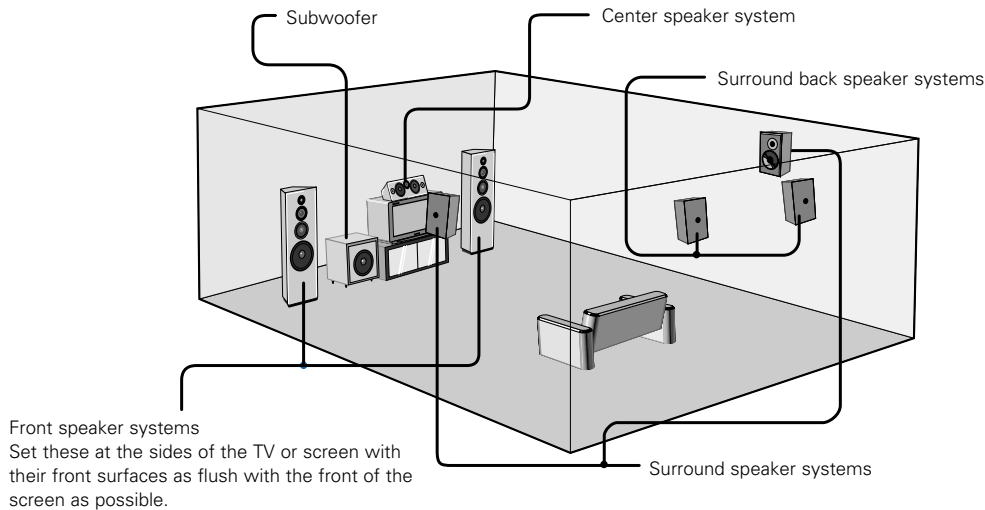

Before setting up the system

- Before setting up, connect the AVR-2803/983's MONITOR OUT connector with the monitor TV and turn off the power of all playback devices connected to the AVR-2803/983's video input connectors. (For instructions on connecting the monitor TV, see page 7 and 8.)

1 Check that all the connections are correct, then turn on the main unit's power.

2 Display the System Setup Menu.



- ※ To stop system setup before it is completed, press the system setup button again. System setup can be stopped at any time. The changed settings are stored and the on-screen display turns off.

System Setup Menu

- ▣ Speaker Configuration
- Delay Time
- Channel Level
- Digital In Assignment
- Video In Assignment
- Dolby Digital Setup
- Zone2 Control

- If you make a mistake at a system setup setting, you can reset it by selecting the desired menu from the System Setup Menu screen. The settings that have been changed up to that point are stored.



Setting the type of speakers

- Set up in function of your speaker systems. Performing this setup optimizes the system.
- The composition of the signals output to the different channels and the frequency response are adjusted automatically according to the combination of speakers actually being used.

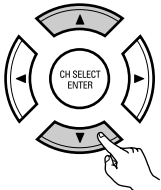
1  At the System Setup Menu select "Speaker Configuration".

System Setup Menu

- ▣ Speaker Configuration
- Delay Time
- Channel Level
- Digital In Assignment
- Video In Assignment
- Dolby Digital Setup
- Zone2 Control

2  Switch to the speaker configuration screen.

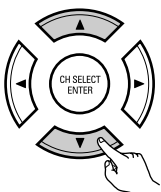
3  Set whether or not speakers are connected and, if so, their size parameters.

- To select the speaker

Speaker Configuration

- ▣ Front Sp. Large Small
- Center Sp. Large Small None
- Subwoofer Yes No

Speaker Configuration

- ▣ Surround
- Sp. Large Small None
- Sp. Back Small None
- 2spkr 1spkr

- To select the parameter

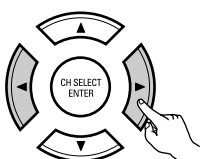
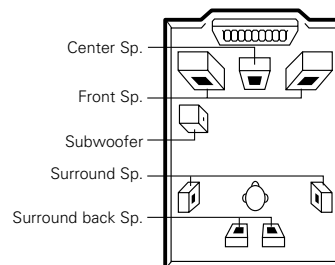
4  Press the ENTER button to finalize the setting.

NOTE:

- Select "Large" or "Small" not according to the actual size of the speaker but according to the speaker's capacity for playing low frequency (bass sound below frequency set for the Crossover Frequency mode and below) signals. If you do not know, try comparing the sound at both settings (setting the volume to a level low enough so as not to damage the speakers) to determine the proper setting.

Parameters

- Large.....Select this when using speakers that have sufficient performance for reproducing bass sound below the frequency set for the Crossover Frequency mode.
- Small.....Select this when using speakers that do not have sufficient performance for reproducing bass sound below the frequency set for the Crossover Frequency mode. When this is set, bass sound with a frequency below the frequency set for the Crossover Frequency mode is sent to the subwoofer. When this setting is selected, low frequencies of below the frequency set for the Crossover Frequency mode are assigned to the subwoofer.
- None.....Select this when no speakers are installed.
- Yes/No.....Select "Yes" when a subwoofer is installed, "No" when a subwoofer is not installed.
- 2spkr/1spkr.....Set the number of speakers to be used for the surround back channel.

- ※ If the subwoofer has sufficient low frequency playback capacity, good sound can be achieved even when "Small" is set for the front, center and surround speakers.
- ※ For the majority of speaker system configurations, using the Small setting for all five main speakers and Subwoofer On with a connected subwoofer will yield the best results.

Setting the crossover frequency and low frequency distribution when playing Dolby Digital and DTS signals

- Set the crossover frequency and subwoofer mode according to the speaker system being used.

1 Select the "Crossover Frequency" mode. Select the frequency.

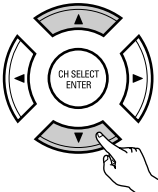
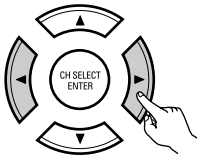
☐ Crossover Frequency

◀ 80Hz ▶

Subwoofer Mode

LFE : LFE
+Main

2 Select the "Subwoofer Mode". Select the setting.

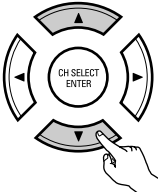
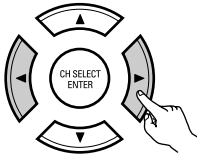
Crossover Frequency

80Hz

☐ Subwoofer Mode

◀ LFE : LFE ▶
+Main

3 Enter the setting.
The System Setup Menu reappears.



NOTES:

— **Assignment of low frequency signal range** —

- The only signals produced from the subwoofer channel are LFE signals (during playback of Dolby Digital or DTS signals) and the low frequency signal range of channels set to "Small" in the setup menu. The low frequency signal range of channels set to "Large" are produced from those channels.

— **Crossover Frequency** —

- When "Subwoofer" is set to "Yes" at the "Speaker Configuration Setting", set the frequency (Hz) below which the bass sound of the various speakers is to be output from the subwoofer (the crossover frequency).
- For speakers set to "Small", sound with a frequency below the crossover frequency is cut, and the cut bass sound is output from the subwoofer instead.

NOTE: For ordinary speaker systems, we recommend setting the crossover frequency to 80 Hz. When using small speakers, however, setting the crossover frequency to a high frequency may improve frequency response for frequencies near the crossover frequency.

— **Subwoofer mode** —

- The subwoofer mode setting is only valid when "Large" is set for the front speakers and "YES" is set for the subwoofer in the "Speaker Configuration" settings (see page 18).
- When the "LFE+MAIN" playback mode is selected, the low frequency signal range of channels set to "Large" are produced simultaneously from those channels and the subwoofer channel.
In this playback mode, the low frequency range expand more uniformly through the room, but depending on the size and shape of the room, interference may result in a decrease of the actual volume of the low frequency range.
- Selection of the "LFE" play mode will play the low frequency signal range of the channel selected with "Large" from that channel only. Therefore, the low frequency signal range that are played from the subwoofer channel are only the low frequency signal range of LFE (only during Dolby Digital or DTS signal playback) and the channel specified as "Small" in the setup menu.
- Select the play mode that provides bass reproduction with quantity.
- When the subwoofer is set to "Yes", bass sound is output from the subwoofer regardless of the subwoofer mode setting in surround modes other than Dolby/DTS.
- In surround modes other than Dolby Digital and DTS, if the subwoofer is set to "YES", the low frequency portion is always output to the subwoofer channel. For details, refer to "Surround Modes and Parameters" on page 60.



Setting the Delay Time

- Input the distance between the listening position and the different speakers to set the delay time for the surround mode.

Preparations:

Measure the distances between the listening position and the speakers (L1 to L5 on the diagram at the right).

- L1: Distance between center speaker and listening position
- L2: Distance between front speakers and listening position
- L3: Distance between surround speakers and listening position
- L4: Distance between surround back speakers and listening position
- L5: Distance between subwoofer and listening position

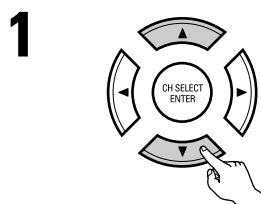
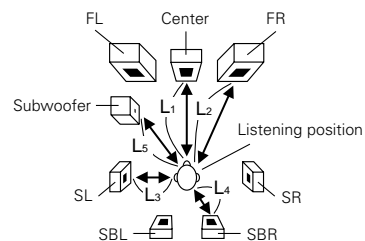

At the System Setup Menu select "Delay Time".

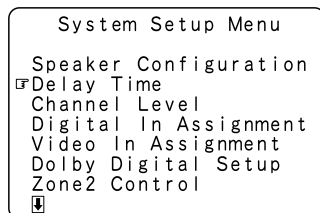

Switch to the Delay Time screen.

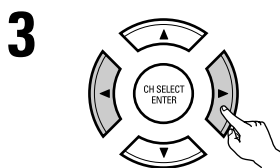
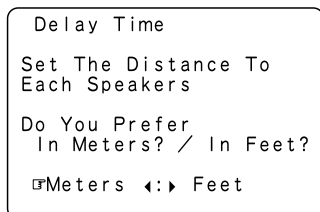

Select the desired unit, meters or feet. Select (darken) the desired units, "Meters" or "Feet".

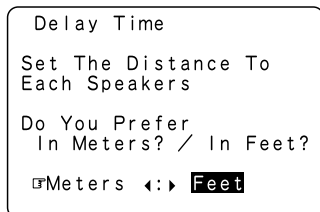

Example: When "Feet" is selected

Once "Meters" or "Feet" is selected in step 3, the Delay Time screen appears automatically.

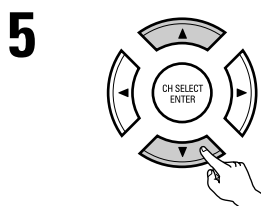
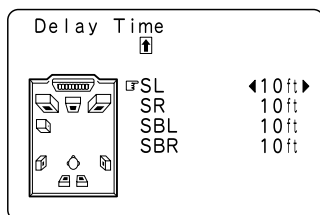
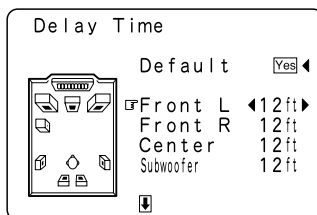

Select the speaker to be set.

6

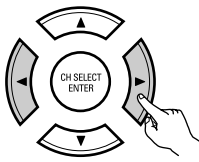

Set the distance between the center speaker and listening position. The distance changes in units of 1 foot (0.1 meters) each time the button is pressed. Select the value closest to the measured distance.

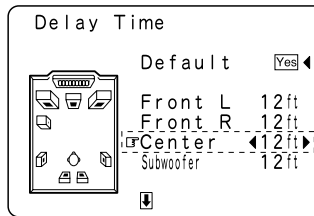

Example: When the distance is set to 12 feet for the center speaker

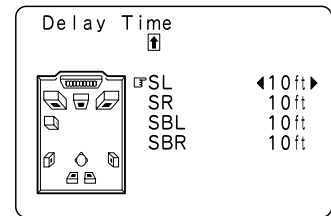

※ If "Yes" is selected for "Default", the settings are automatically reset to the default values.

Please note that the difference of distance for every speaker should be 20 ft (6.0 m) or less. If you set an invalid distance, a CAUTION notice, such as screen right will appear. In this case, please relocate the blinking speaker(s) so that its distance is no larger than the value shown in highlighted line.

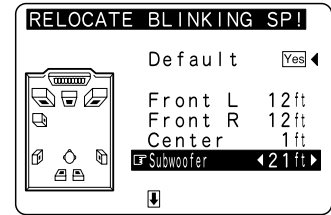

7



Enter the setting. The System Setup Menu reappears. The AVR-2803/983 automatically sets the optimum surround delay time for the listening room.

NOTE:

- If the distance unit is changed after the delay time is set, the settings are reset to the factory default values (see page 16, 17).

Setting the Channel Level

- Use this setting to adjust so that the playback level between the different channels is equal.
- From the listening position, listen to the test tones produced from the speakers to adjust the level.
- The level can also be adjusted directly from the remote control unit. (For details, see page 49.)

1

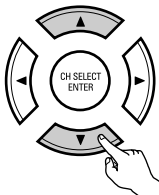

At the System Setup Menu select "Channel Level".

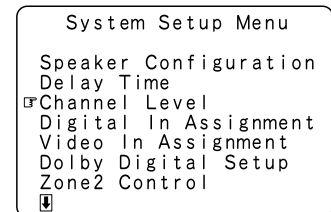

2



Switch to the Channel Level screen.

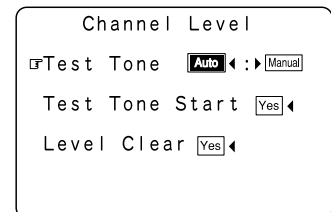

3

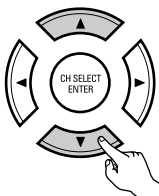

Select "Test Tone".

4

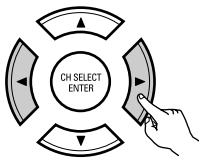

Select the mode.
Select "Auto" or "Manual".

- Auto:
Adjust the level while listening to the test tones produced automatically from the different speakers.
- Manual:
Select the speaker from which you want to produce the test tone to adjust the level.

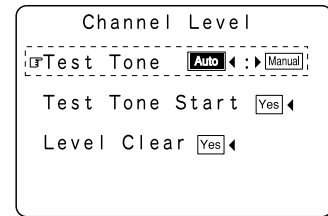

Example: When the "Auto" mode is selected

5

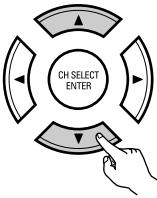

Select "Test Tone Start".

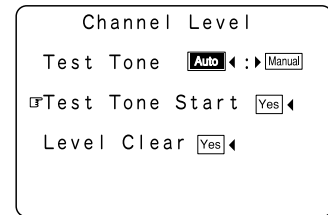

6



Select "Yes".

7

- a. If the "Auto" mode is selected:
Test tones are automatically emitted from the different speakers.
The test tones are emitted from the different speakers in the following order, at 4-second intervals the first time and second time around, 2-second intervals the third time around and on:

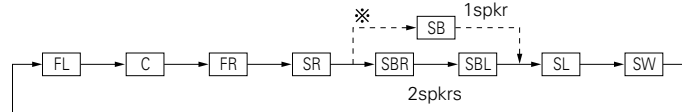

※ When the surround back speaker setting is set to "1spkr" for "Speaker Configuration", this is set to "SB".

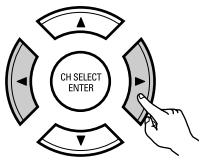

Use the CURSOR left and right buttons to adjust all the speakers to the same volume.
The volume can be adjusted between -12 dB and +12 dB in units of 0.5 dB.

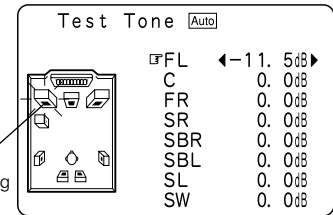

Example: When the volume is set to -11.5 dB while the test tone is being produced from the Front Lch speaker

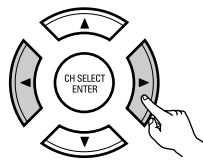
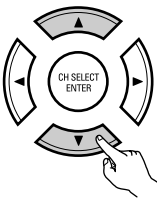

- b. When the "Manual" mode is selected
Use the CURSOR up and down to select the speaker for which you want to output test tones, then use the CURSOR left and right to adjust so that the volume of the test tones from the various speakers is the same.

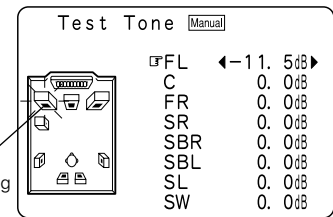

Example: When the volume is set to -11.5 dB while the Front Lch speaker is selected

8



After the above settings are completed, press the ENTER button.
The "Channel Level" screen reappears.

※ To cancel the settings, select "Level Clear" and "Yes" on the "Channel Level" screen, then make the settings again.

The level of each channel should be adjusted to 75 dB (C-weighted, slow meter mode) on a sound level meter at the listening position.
If a sound level meter is not available adjust the channels by ear so the sound levels are the same. Because adjusting the subwoofer level test tone by ear is difficult, use a well known music selection and adjust for natural balance.

NOTE: When adjusting the level of an active subwoofer system, you may also need to adjust the subwoofer's own volume control.

- ※ When you adjust the channel levels while in the SYSTEM SETUP CHANNEL LEVEL mode, the channel level adjustments made will affect all surround modes. Consider this mode a Master Channel Level adjustment mode.
- ※ After you have completed the SYSTEM SETUP CHANNEL LEVEL adjustments, you can then activate the individual surround modes and adjust channel levels that will be remembered for each of those modes. Then, whenever you activate a particular surround sound mode, your preferred channel level adjustments for just that mode will be recalled. Check the instructions for adjusting channel levels within each surround mode on page 49.
- ※ You can adjust the channel levels for each of the following surround modes: DIRECT, STEREO, DOLBY/DTS SURROUND, 5/7 CH STEREO, MONO MOVIE, ROCK ARENA, JAZZ CLUB, VIDEO GAME, MATRIX and VIRTUAL.

Setting the Digital In Assignment

- This setting assigns the digital input jacks of the AVR-2803/983 for the different input sources.

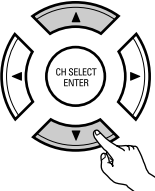
- 

At the System Setup Menu select "Digital In Assignment".

System Setup Menu

 - Speaker Configuration
 - Delay Time
 - Channel Level
 - ▣ Digital In Assignment
 - Video In Assignment
 - Dolby Digital Setup
 - Zone2 Control
- 

Switch to the Digital Inputs screen.

Digital In Assignment

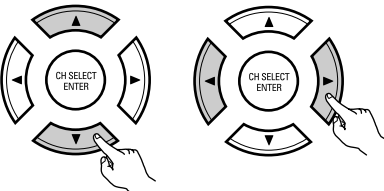
 - ▣ CD: COAX1 VCR-1: OFF
 - DVD: COAX2 VCR-2: OFF
 - VDP: OPT1 Tape: OPT4
 - TV: OPT2
 - DBS: OPT3
 - V.Aux: OFF Default Yes
- 

Select the digital input jack to be assigned to the input source.

 - To select the input source
 - To select the digital input jack

Select "OFF" for input sources for which no digital input jacks are used.

※ If "Yes" is selected for "Default", the settings are automatically reset to the default values.
- 

Enter the setting.
The System Setup Menu reappears.

NOTES:

- The OPTICAL 4 jacks on the AVR-2803/983's rear panel are equipped with an optical digital output jack for recording digital signals on a CD recorder, MD recorder or other digital recorder. Use this for digital recording between a digital audio source (stereo - 2 channel) and a digital audio recorder.
- Do not connect the output of the component connected to the OPTICAL 4 OUT jack on the AVR-2803/983's rear panel to any jack other than the OPTICAL 4 IN jack.
- "PHONO" and "TUNER" cannot be selected on the Digital In Assignment.

Setting the Video In Assignment

- This setting assigns the color difference (component) video input jacks of the AVR-2803/983 for the different input sources.

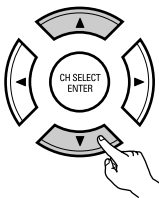
1  At the System Setup Menu select "Video In Assignment".

System Setup Menu

Speaker Configuration

Delay Time

Channel Level

Digital In Assignment

Video In Assignment

Dolby Digital Setup

Zone2 Control



2  Switch to the Video In Assignment screen.

Video In Assignment

DVD: VIDEO1

VDP: NONE

TV: NONE

DBS: VIDEO2

VCR-1: NONE

VCR-2: NONE

V.Aux: NONE

Default Yes

3 Select the component (Y, Pb/Cb and Pr/Cr) video input terminal to be assigned to the input source.

① Input source selection

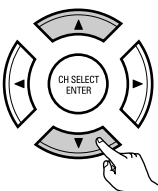

② Component video terminal selection

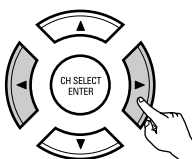

Select "NONE" for sources for which the component (Y, Pb/Cb and Pr/Cr) video input is not to be used.

※ When the default, "Yes", is selected, the settings are reset to the factory defaults.



4  ENTER the setting.
The System Setup Menu reappears.

Setting the Dolby Digital Setup

Sets the down-mixing method when not using a center speaker or surround speakers.

OFF: The dynamic range is not compressed.

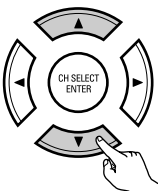
ON: The dynamic range is compressed automatically according to the combination of speakers being used.

1   At the System Setup Menu select "Dolby Digital Setup" and press the ENTER button.

System Setup Menu

Speaker Configuration

Delay Time

Channel Level

Digital In Assignment

Video In Assignment

Dolby Digital Setup

Zone2 Control

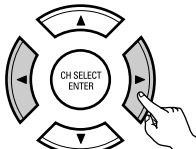

2  Select "ON" if you want to use the Compression, "OFF" if you do not want to use it.

NOTE:
When not using a center speaker or surround speakers, the sound is played from the front speakers. If the sound should seem distorted because the input level exceeds the allowable input for the front speakers, set "Compression" to "ON".

Dolby Digital Downmix Option Setup

Compression

ON  OFF

3



Enter the setting.
The System Setup Menu reappears.

Setting the ZONE2 Control

[1] Setting the power amplifier assignment

Make this setting to switch the power amplifier for the surround back channel to ZONE2.
If ZONE2 is selected, the signal that selected at ZONE2 is output at "SURR. BACK/ZONE2 PREOUT" terminals.

1

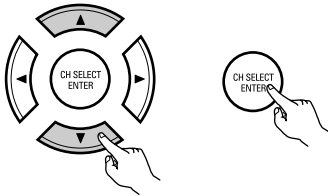

At the System Setup Menu select "Zone2 Control" and press the ENTER button.

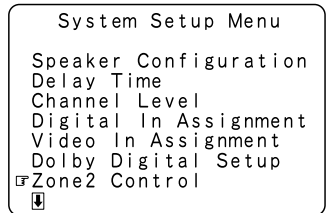

2

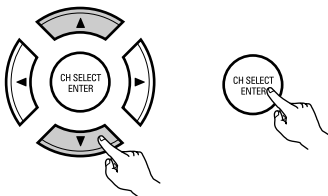

The "Zone2 Control" screen appears.
Select "Power Amp Assignment" and press the ENTER button.

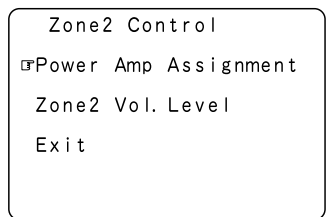

3

Select "Surround Back" to use as the surround back channel, "Zone2" to use as Zone 2 out.

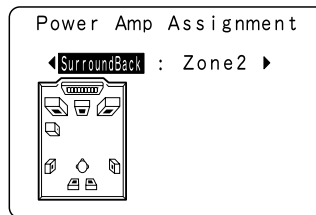
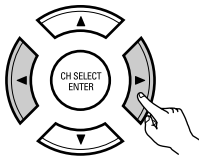

When "Surround Back" is selected

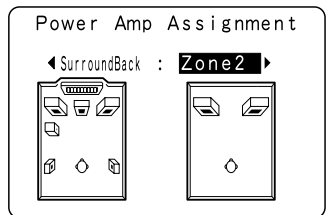

When "Zone2" is selected

4



Enter the setting.
At the "Zone2 Control" screen, select "Exit" and press the ENTER button.
The System Setup Menu reappears.

[2] Setting the Zone2 vol. level

Set the Zone 2 pre-out output level adjustment.

1

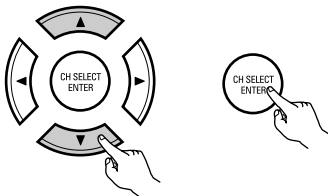

At the System Setup Menu select "Zone2 Control" and press the ENTER button.

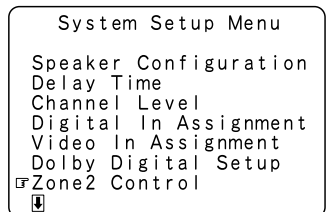

2

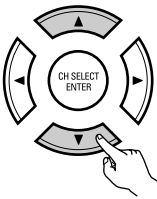

The "Zone2 Control" screen appears. Select "Zone2 Vol. Level" and press the ENTER button.

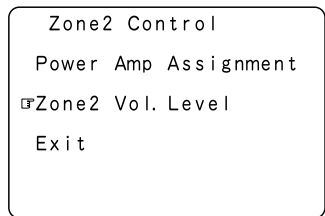

3

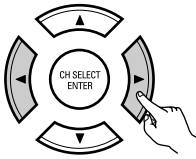

Select the desired setting.

Variable:

The level can be adjusted freely using the buttons on the remote control unit.

0 dB, -40 dB:

The output level is fixed at the set level and the volume can no longer be adjusted.

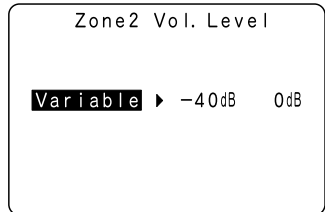

4



Enter the setting.

At the "Zone2 Control" screen, select "Exit" and press the ENTER button. The System Setup Menu reappears.

Setting the Ext. In Subwoofer Level

- Set the method of playback of the analog input signal connected to the Ext.In Subwoofer.

1

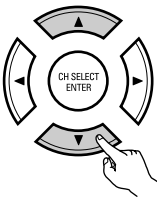

At the System Setup Menu select "Ext.In Subwoofer Level".

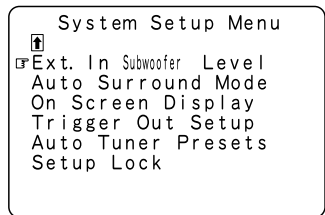

2



Switch to the Ext.In Subwoofer Level screen.

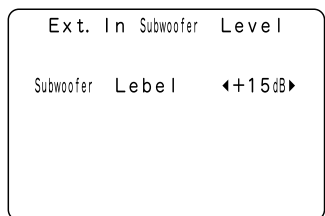

3

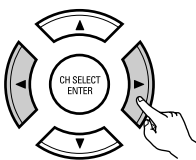

Select the desired setting.

Select according to the specifications of the player being used. Also refer to the player's operating instructions. +15dB (default) recommended. (0, +5, +10 and +15 can be selected.)

4



Enter the setting.

The System Setup Menu reappears.

Setting the Auto Surround Mode

The surround mode used at last for the three types of input signals shown below is stored in the memory, and the signal is automatically played with that surround mode the next time it is input.

Note that the surround mode setting is also stored separately for the different input sources.

- ① Analog and PCM 2-channel signals
- ② 2-channel signals of Dolby Digital, DTS or other multi-channel format
- ③ Multi-channel signals of Dolby Digital, DTS or other multi-channel format

1

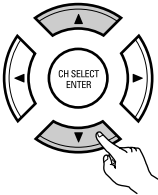

At the System Setup Menu select "Auto Surround Mode" and press the ENTER button.

System Setup Menu

- Ext. In Subwoofer Level
- Auto Surround Mode
- On Screen Display
- Trigger Out Setup
- Auto Tuner Presets
- Setup Lock

2

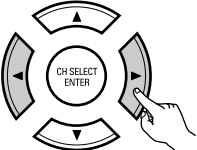

Select "ON" if you want to use the auto surround mode, "OFF" if you do not want to use it.

Auto Surround Mode

ON ◀ : ▶ OFF

3



Enter the setting.
The System Setup Menu reappears.

Setting the On Screen Display (OSD)

- Use this to turn the on-screen display (messages other than the menu screens) on or off.

1

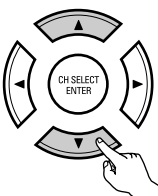

At the System Setup Menu select "On Screen Display" and press the ENTER button.

System Setup Menu

- Ext. In Subwoofer Level
- Auto Surround Mode
- On Screen Display
- Trigger Out Setup
- Auto Tuner Presets
- Setup Lock

2

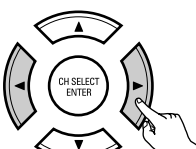

Select "ON" or "OFF".

On Screen Display

ON ◀ : ▶ OFF

3



Enter the setting.
The System Setup Menu reappears.

Setting the Trigger Out Setup

- Sets the Trigger Out output for the different input sources.

1 At the System Setup Menu select "Trigger Out Setup".

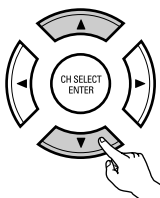

System Setup Menu

- Ext. In Subwoofer Level
- Auto Surround Mode
- On Screen Display
- Trigger Out Setup
- Auto Tuner Presets
- Setup Lock

2 Switch to the Trigger Out Setup screen.



Trigger Out Setup

Phono:	OFF	DBS:	ON
CD:	OFF	VCR-1:	ON
Tuner:	OFF	VCR-2:	ON
Tape:	OFF	V.Aux:	ON
DVD:	ON		
VDP:	ON		
TV:	ON		

Default Yes

3 Select the input source and select "ON" or "OFF".

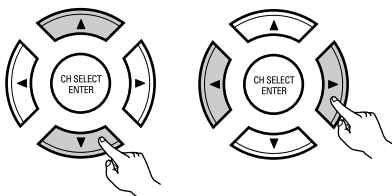

4 Enter the setting.
The System Setup Menu reappears.



Auto Tuner Presets

Use this to automatically search for FM broadcasts and store up to 40 stations at preset channels A1 to 8, B1 to 8, C1 to 8, D1 to 8 and E1 to 8.

NOTE:

- If an FM station cannot be preset automatically due to poor reception, use the "Manual tuning" operation to tune in the station, then preset it using the manual "Preset memory" operation.

1 At the System Setup Menu select "Auto Tuner Presets".

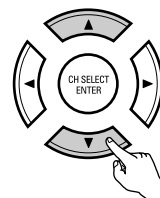

System Setup Menu

- Ext. In Subwoofer Level
- Auto Surround Mode
- On Screen Display
- Trigger Out Setup
- Auto Tuner Presets
- Setup Lock

2 Switch to the Auto Preset Memory screen.



Auto Preset Memory

Auto Tuning &
Preset Station Memory
Storing Preset Memory

Start Yes

3



Use the CURSOR button to select "Yes".
"Search" flashes on the screen and searching begins.
"Completed" appears once searching is completed.
The display automatically switches to screen.

Protecting the setting

The system setup settings can be locked so that they cannot be changed easily.

1

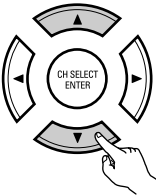

At the System Setup Menu select "Setup Lock".

```

System Setup Menu
┌─┐
Ext. In Subwoofer Level
Auto Surround Mode
On Screen Display
Trigger Out Setup
Auto Tuner Presets
└─┘ Setup Lock

```

2



Switch to the Setup Lock screen.

3



Select "ON", to lock the system setup settings.

```

Setup Lock

ON ◀ : ▶ OFF

```

4



Press the ENTER to finalize the setting and exit the system setup mode.

When the setup lock function is activated, the settings listed below cannot be changed, and "Setup Locked" is displayed when related buttons are operated.

- System setup settings
- Surround parameter settings
- Tone control settings
- Channel level settings (including test tones)

To unlock, press the System Setup button again and display the Setup Lock screen, then select "OFF" and press "ENTER".

※ System setup is complete. Once these settings are made, there is no need to change them unless different AV components are connected or the speakers are repositioned.

After completing system setup

This button can be pressed at any time during the system setup process to complete the process.

1



At the System Setup Menu, press the SYSTEM SETUP button.
 ※ The changed settings are entered and the on-screen display turns off.

• On-screen display signals

	Signals input to the AVR-2803		On-screen display signal output	
	VIDEO signal input jack (yellow)	S-video signal input jack	VIDEO MONITOR OUT video signal output jack (yellow)	S-video MONITOR OUT video signal output jack
1	×	×	○	○
2	○	×	○	×
3	×	○	×	○
4	○	○	×	○

(○): Signal ×: No signal)

(○): On-screen signals output ×: On-screen signals not output)

NOTES:

- The on-screen display signals are not output from the color difference (component) video signal MONITOR OUT jacks.
- For 4 above, the on-screen display signals are output to the VIDEO MONITOR OUT video signal output jack (yellow) if the monitor TV is not connected to the S-video MONITOR OUT video signal output jack.

8 REMOTE CONTROL UNIT

- The included remote control unit (RC-924) can be used to operate not only the AVR-2803/983 but other remote control compatible DENON components as well. In addition, the memory contains the control signals for other remote control units, so it can be used to operate non-Denon remote control compatible products.

Inserting the batteries

- ① Remove the remote control unit's rear cover.

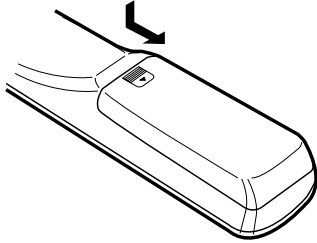

- ② Set three R6P/AA batteries in the battery compartment in the indicated direction.

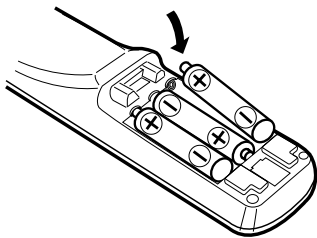

- ③ Put the rear cover back on.

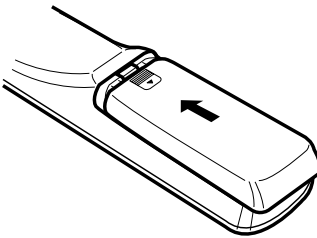

Notes on Batteries

- Use R6P/AA batteries in the remote control unit.
- The batteries should be replaced with new ones approximately once a year, though this depends on the frequency of usage.
- Even if less than a year has passed, replace the batteries with new ones if the set does not operate even when the remote control unit is operated nearby the set. (The included battery is only for verifying operation. Replace it with a new battery as soon as possible.)
- When inserting the batteries, be sure to do so in the proper direction, following the “+” and “-” marks in the battery compartment.
- To prevent damage or leakage of battery fluid:
 - Do not use a new battery together with an old one.
 - Do not use two different types of batteries.
 - Do not short-circuit, disassemble, heat or dispose of batteries in flames.
- Remove the batteries from the remote control unit when you do not plan to use it for an extended period of time.
- If the battery fluid should leak, carefully wipe the fluid off the inside of the battery compartment and insert new batteries.
- When replacing the batteries, have the new batteries ready and insert them as quickly as possible.

Using the remote control unit

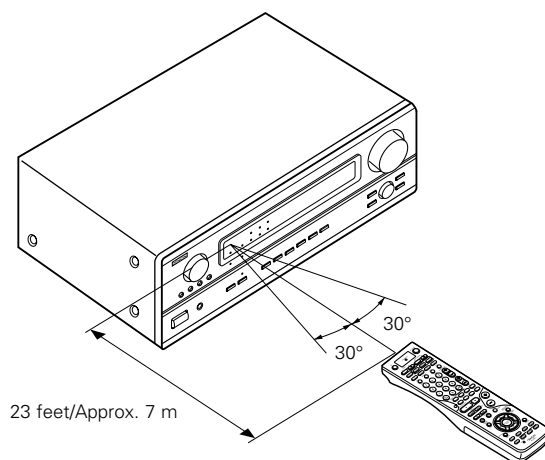

- Point the remote control unit at the remote sensor on the main unit as shown on the diagram.
- The remote control unit can be used from a straight distance of approximately 23 feet / 7 meters from the main unit, but this distance will be shorter if there are obstacles in the way or if the remote control unit is not pointed directly at the remote sensor.
- The remote control unit can be operated at a horizontal angle of up to 30 degrees with respect to the remote sensor.

NOTES:

- It may be difficult to operate the remote control unit if the remote sensor is exposed to direct sunlight or strong artificial light.
- Do not press buttons on the main unit and remote control unit simultaneously. Doing so may result in malfunction.
- Neon signs or other devices emitting pulse-type noise nearby may result in malfunction, so keep the set as far away from such devices as possible.

Operating DENON audio components

- 1** Use the mode selector buttons to select the component you want to operate.
 ※ The function will change one step in the sequence described below each time the MODE SELECT button is pressed.

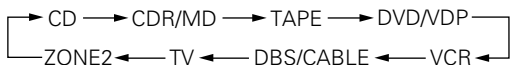

- 2** Operate the audio component.
 • For details, refer to the component's operating instructions.
 ※ It may not be possible to operate some models.

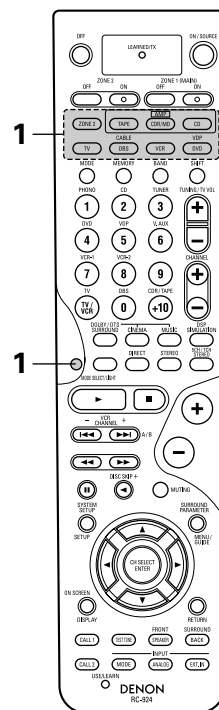

1. CD player (CD) system buttons

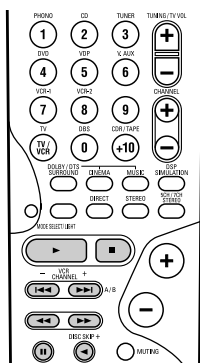

2. Tape deck (TAPE) system buttons

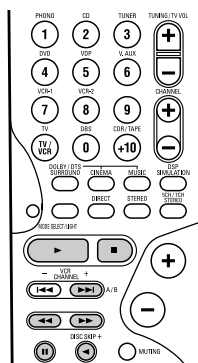

- ◀▶ : Manual search (forward and reverse)
- : Stop
- ▶ : Play
- ◀◀, ▶▶ : Auto search (to beginning of track)
- ⏸ : Pause
- DISC SKIP + : (for CD changers only)

- ◀◀ : Rewind
- ▶▶ : Fast forward
- : Stop
- ▶ : Forward play
- ⏸ : Pause
- ◀ : Reverse play
- A/B : Switch between sides A and B

3. MD recorder (MD), CD recorder (CDR) system buttons

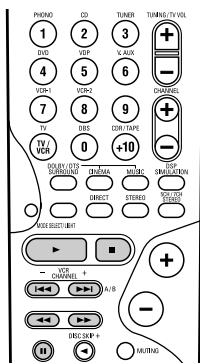

- ◀▶ : Manual search (forward and reverse)
- : Stop
- ▶ : Play
- ◀◀, ▶▶ : Auto search (to beginning of track)
- ⏸ : Pause

4. Tuner system buttons

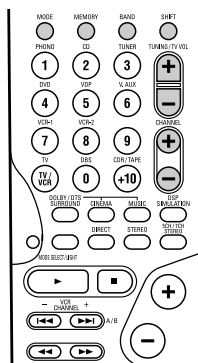

- TUNING +, - : Tuning up/down
- BAND : Switch between AM and FM bands
- MODE : Switch between AUTO and MANUAL
- MEMORY : Preset memory
- SHIFT : Switch preset channel range
- CHANNEL +, - : Preset channel up/down

※ Default setting = CDR

※ The tuner can be operated in the amplifier (CD, CDR/MD, or TAPE) mode.

Preset memory

The included remote control unit can be used to operate devices of different brands by registering the preset number corresponding to the brand of your device.

For some models the remote control unit or the device may not operate properly. In this case, use the learning function (page 36) to store your device's remote control signals in the included remote control unit.

1 Press the power ON/SOURCE button and the OFF button at the same time.

- The LEARNED/TX indicator flashes.



2 Press the mode button of the equipment that is to be entered to a preset memory.

- The mode button flashes.

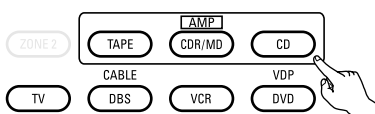

3 Referring to the included List of Preset Codes, use the number buttons to input the preset code (a 4-digit number) for the manufacturer of the component whose signals you want to store in the memory.

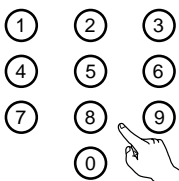

4 When stored correctly, the mode button and the LEARNED/TX indicator will light.

5 To store the codes of another component in the memory, repeat steps 1 to 4.

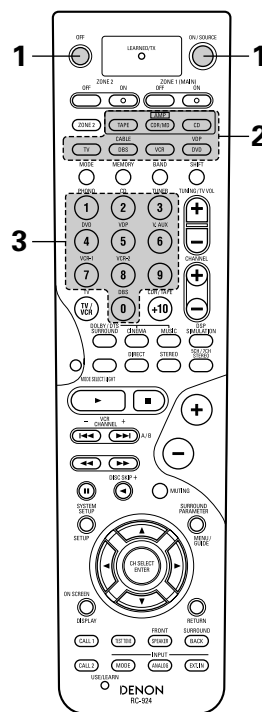

NOTES:

- Depending on the model and year of manufacture, this function cannot be used for some models, even if your device is listed on the included list of preset codes.
- Some manufacturers use more than one type of remote control code. Refer to the included list of preset codes to change the number and check it out.
- The preset memory can be set for one component only among the following: CDR/MD, DVD/VDP and DBS/CABLE.**

The preset codes are as follows upon shipment from the factory and after resetting:

TV, VCR	HITACHI
CD, TAPE	DENON
CDR/MD	DENON (CDR)
DVD/VDP	DENON (DVD)
DBS/CABLE	ABC (CABLE)

DVD preset codes	0000	0001
DENON Model No.	DVD-900	DVD-800
	DVD-1000	DVD-1600
	DVD-1500	DVD-2000
	DVD-2800	DVD-2500
	DVD-2800II	DVD-3000
	DVD-3800	DVD-3300
	DVD-9000	
	DVM-1800	
	DVM-4800	

Operating a component stored in the preset memory

- 1** Press the mode selector button for the component you want to operate.

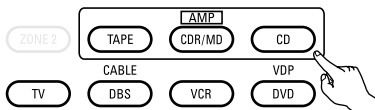

NOTE:

- For the DVD player remote control buttons, function names may differ according to manufacturer. Compare with the remote control operation of the various components.

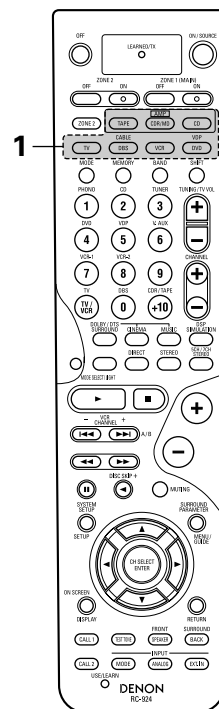

- 2** Operate the component.
- For details, refer to the component's operating instructions.
 - ※ Some models cannot be operated with this remote control unit.

1. Digital video disc player (DVD, DVD SETUP) system buttons

- POWER : Power on/standby (ON/SOURCE)
- ◀▶▶▶ : Manual search (forward and reverse)
- : Stop
- ▶ : Play
- ◀◀◀▶▶▶ : Auto search (to beginning of track)
- ⏸ : Pause
- 0 ~ 9, +10 : 10 key
- DISC SKIP + : Disc skip (for DVD changer only)
- DISPLAY : Display
- MENU : Menu
- RETURN : Return
- SETUP : Setup
- ENTER : Enter
- ▲, ▼, ◀, ▶ : Cursor up, down, left and right

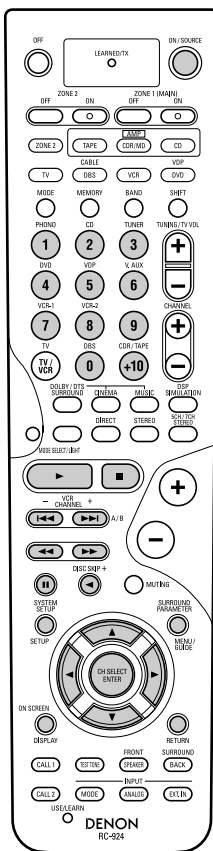

2. Video disc player (VDP) system buttons

- POWER : Power on/standby (ON/SOURCE)
- ◀▶▶▶ : Manual search (forward and reverse)
- : Stop
- ▶ : Play
- ◀◀◀▶▶▶ : Auto search (cue)
- ⏸ : Pause
- 0~9, +10 : 10 key

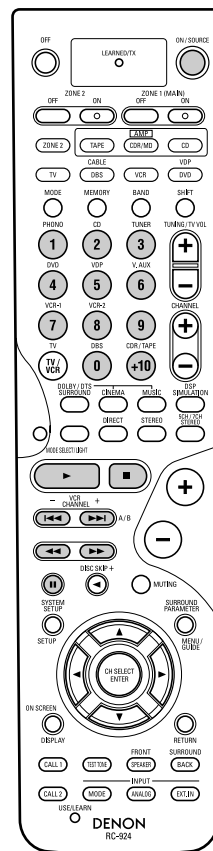

Learning function

If your AV component is not a Denon product or if it cannot be operated using the preset memory, it can be controlled with the accessories remote control unit by storing its remote control signals in the remote control unit.

For some remote control signals it is not possible to "learn" the signals or the device will not operate properly. In such cases use the remote control unit included with the device to operate it.

1 Press the USE/LEARN button with the tip of a pen etc., to set the learn mode.

- Both the mode selector buttons and LEARNED/TX indicator flash.

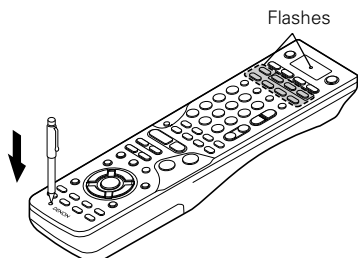

2 Press the mode button of the equipment for which learning is desired.

- Mode button and LEARNED/TX indicator flash.

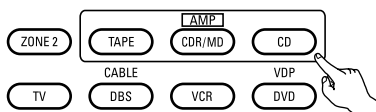

3 Press the button that is to be learned. The LEARNED/TX indicator stops flashing and the mode button lights.

- Mode button and LEARNED/TX indicator flashed if a button that cannot be "learned" is pressed.
- To cancel, press the USE/LEARN button.

4 Point the remote control units directly at each other and press and hold in the button on the other remote control unit which you want to "learn".

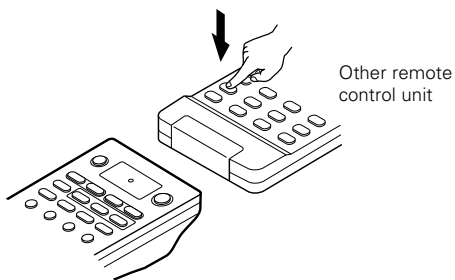

5 The mode button and the LEARNED/TX indicator lights, release the button on the other remote control unit.

- The mode button and the LEARNED/TX indicator start flashing again.

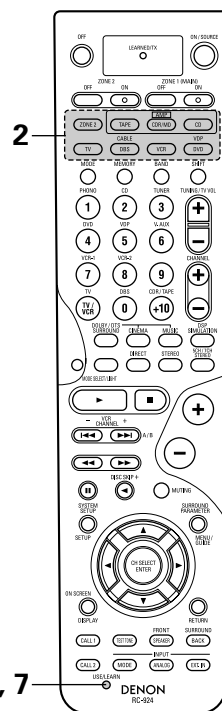
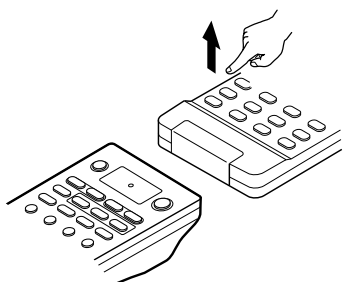

6 To "learn" other buttons, repeat steps 2 to 5.

7 Once the learning operation is completed, press the USE/LEARN button again.

The mode button and the LEARNED/TX indicator stop flashing and the learning mode is cancelled.

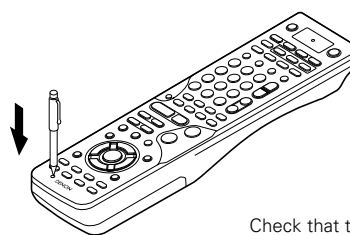

Check that the stored codes work properly.

NOTES:

- If the codes could not be stored, the LEARNED/TX indicator start flashing rapidly. For limited number of models, codes cannot be stored in RC-924.
- If the mode button and LEARNED/TX indicator start flashing rapidly, this means that the memory is already full, and the code you have just attempted to store was not stored. To "learn" that code, first perform the resetting operation. (See page 39.)

System call

The accessorious remote control unit is equipped with "system call" function allowing a series of remote control signals to be transmitted by pressing a single button.

This function can be used for example to turn on the amplifier's power, select the input source, turn on the monitor TV's power, turn on the source component's power and set the source to the play mode, all at a signal button.

(1) System call buttons

Up to 10 signals each can be stored at the "CALL1" and "CALL2" buttons.

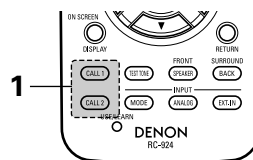

(2) Storing system call signals

1 Press the power ON/SOURCE button and the OFF button at the same time.

- The LEARNED/TX indicator flashes.



2 Press the CALL 1 button.

- The mode selector buttons and LEARNED/TX indicator flash.



3 Press the mode buttons of the equipment that is to be registered to System Call.

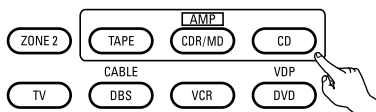

4 Press the buttons whose remote control signals you want to store one by one.

5 Repeat steps 3 and 4 to register the desired buttons.

6 Press the CALL1 or CALL2 button and register System Call.

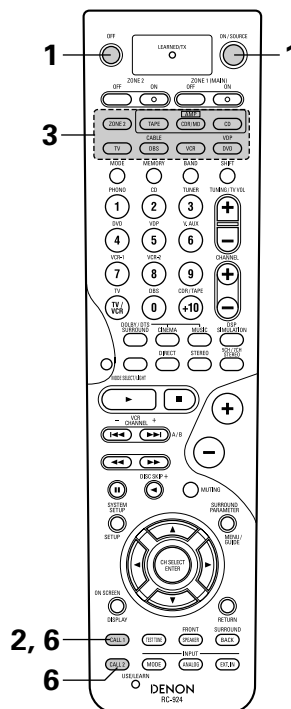

NOTES:

- The remote control signals for the buttons pressed while storing the system call signals are transmitted when the buttons are pressed, so cover the remote sensor or take other measures so that the components do not operate while the signals are being stored.
- The mode button and LEARNED/TX indicator flashing rapidly if you have already stored the maximum number of signals.

(3) Using the system call function

- 1** Press the button at which the system call signals have been stored.
 - The stored signals are transmitted successively.

Punch Through

(1) Punch through button

Buttons used in the CD, CDR/MD, TAPE, DVD/VDP, and VCR modes can be assigned to the buttons shown on the diagram at the right which are not normally used in the TV and DBS/CABLE modes.

For example, when the CD mode is set to the punch through mode in the TV mode, the CD mode's PLAY, STOP, MANUAL SEARCH, AUTO SEARCH, PAUSE and DISC SKIP buttons' signals are sent in the TV mode.

(2) Making the punch through setting

- 1** Press the power ON/SOURCE button and the OFF button at the same time.
 - The LEARNED/TX indicator flashes.



- 2** Press the ► (play) button.
 - TV and DBS/CABLE mode buttons and LEARNED/TX indicator flash.

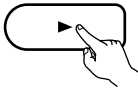

- 3** Press the mode button of the equipment for which Punch Through is to be set.
 - The CD, CDR/MD, TAPE, DVD/VDP, and VCR mode buttons and LEARNED/TX indicator will flash.

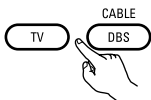

- 4** Press the mode button of the equipment that is to be punched through.
 - The mode button that was set will light.

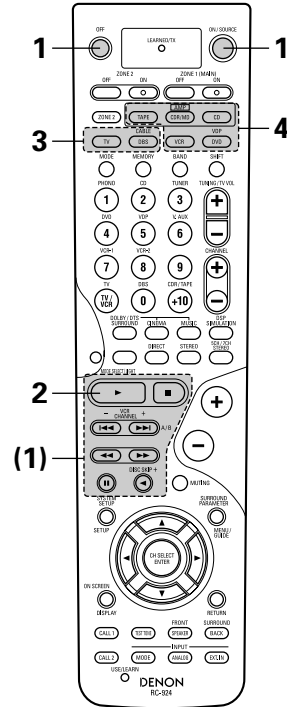
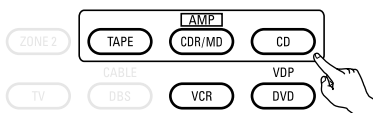

Resetting

(1) Resetting "learned" buttons

- 1** Press the USE/LEARN button with the tip of a pen, etc., to set the learn mode.
- The mode selector buttons and LEARNED/TX indicator flash.

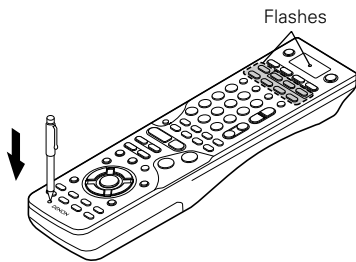

- 2** Press the mode button of the equipment that is to be reset.
- Mode button and LEARNED/TX indicator flash.

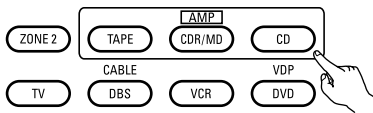

- 3** Hold for 4 seconds or longer the mode button of the equipment that is to be reset and the ON/SOURCE button.
- The mode button and the LEARNED/TX indicator will again flash, and the learned remote control signal of the selected equipment will be deleted.

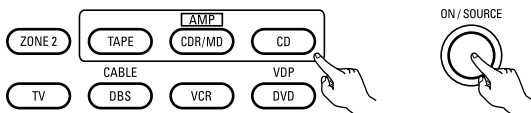

- 4** Press the USE/LEARN button.

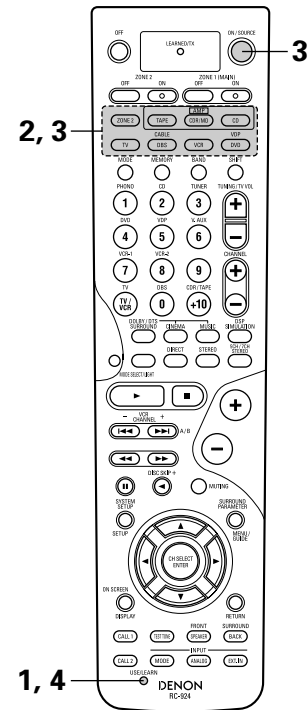
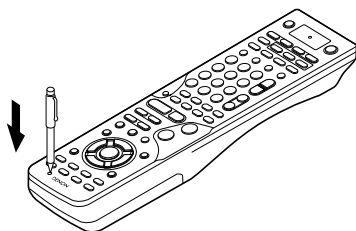

(2) Resetting the punch through setting

- 1** Press the power ON/SOURCE button and the OFF button at the same time.
- The LEARNED/TX indicator flashes.



- 2** Press the ► (play) button.
- TV and DBS/CABLE mode buttons and TEARNED/TX indicator flash.

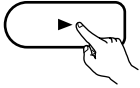

- 3** Press the mode button of the equipment (TV or DBS/CABLE) that is to be reset.
- The CD, CDR/MD, TAPE, DVD/VDP, and VCR mode buttons and TEARNED/TX indicator will flash.

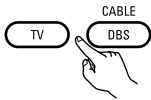

- 4** Press the mode button of the equipment that is to be reset again.
- During the resetting operation, the selected mode button and the LEARNED/TX indicator will light; they will return to steady state upon completion.

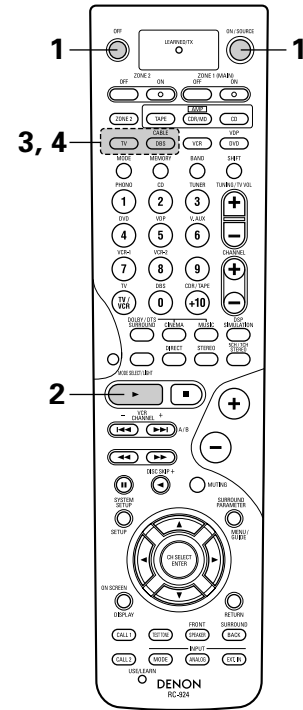
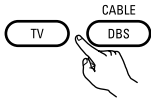

9 OPERATION

Before operating

- 1 Refer to "CONNECTIONS" (pages 6 to 13) and check that all connections are correct.
- 2 Select "AMP mode" using the TAPE, CDR/MR or CD button. (only when operating with the remote control unit)

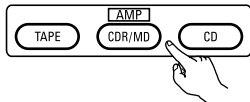

(Remote control unit)

- 3 Turn on the power. Press the POWER switch (button).

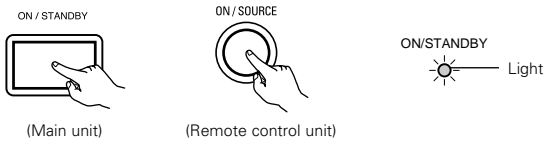

When pressed, the power turns on and the display lights. The sound is muted for several seconds, after which the unit operates normally. When pressed again, the power turns off, the standby mode is set and the display turns off. Whenever the ON/STANDBY button is in the STANDBY state, the apparatus is still connected on AC line voltage. Please be sure to unplug the cord when you leave home for, say, a vacation.

- 4 The front speakers switch as shown below each time the FRONT SPEAKER button is pressed.

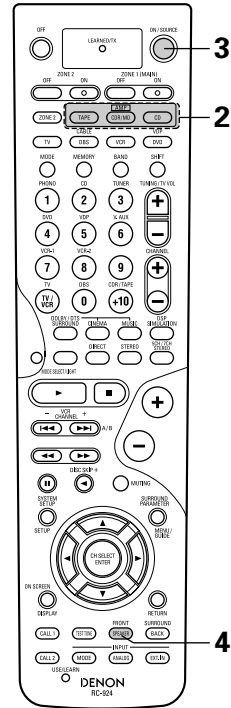
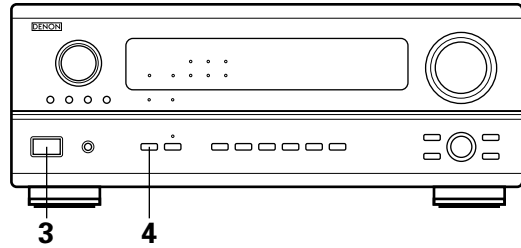
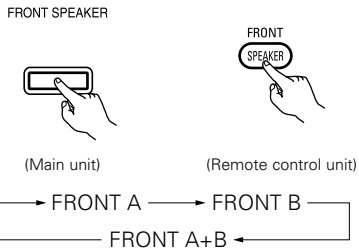

Playing the input source

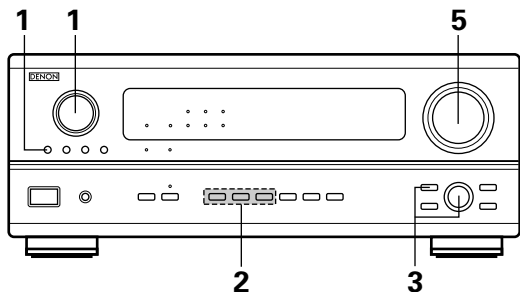

1 Select the input source to be played.

Example: CD

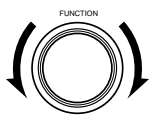

(Main unit)

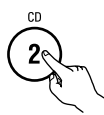

(Remote control unit)

※ To select the input source when ZONE2/REC OUT or TUNING PRESET is selected, press the SOURCE button then operate the input function selector.

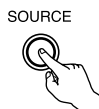

(Main unit)

2 Select the input mode.

- Selecting the analog mode
Press the ANALOG button to switch to the analog input.



(Main unit)



(Remote control unit)

- Selecting the external input (EXT. IN) mode
Press the EXT. IN (on the EXT. IN button on the remote control unit) to switch the external input.



(Main unit)



(Remote control unit)

- Selecting the AUTO, PCM and DTS modes
The mode switches as shown below each time the INPUT MODE button is pressed.

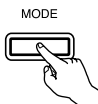

(Main unit)



(Remote control unit)

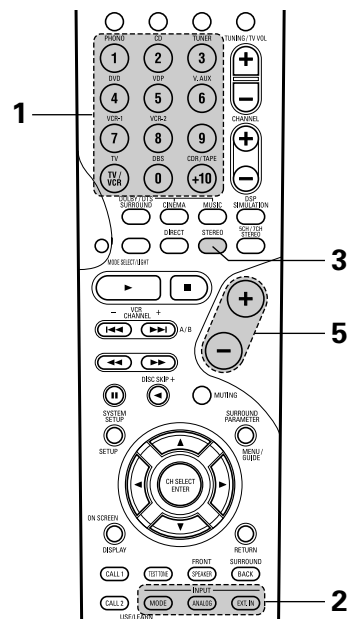

Input mode selection function

Different input modes can be selected for the different input sources. The selected input modes for the separate input sources are stored in the memory.

① AUTO (auto mode)

In this mode, the types of signals being input to the digital and analog input jacks for the selected input source are detected and the program in the AVR-2803/983's surround decoder is selected automatically upon playback. This mode can be selected for all input sources other than PHONO and TUNER.

The presence or absence of digital signals is detected, the signals input to the digital input jacks are identified and decoding and playback are performed automatically in DTS, Dolby Digital or PCM (2 channel stereo) format. If no digital signal is being input, the analog input jacks are selected.

Use this mode to play Dolby Digital signals.

② PCM (exclusive PCM signal playback mode)

Decoding and playback are only performed when PCM signals are being input.

Note that noise may be generated when using this mode to play signals other than PCM signals.

③ DTS (exclusive DTS signal playback mode)

Decoding and playback are only performed when DTS signals are being input.

④ ANALOG (exclusive analog audio signal playback mode)

The signals input to the analog input jacks are played.

⑤ EXT. IN (external decoder input jack selection mode)

The signals being input to the external decoder input jacks are played without passing through the surround circuitry.

NOTE:

- Note that noise will be output when CDs or LDs recorded in DTS format are played in the "PCM" (exclusive PCM signal playback) or "ANALOG" (exclusive PCM signal playback) mode. Select the AUTO or DTS mode when playing signals recorded in DTS from a laser disc player or CD player.

Note on playing a source encoded with DTS

- Noise may be generated at the beginning of playback and while searching during DTS playback in the AUTO mode. If so, play in the DTS mode.

3 Select the play mode.

Example: Stereo

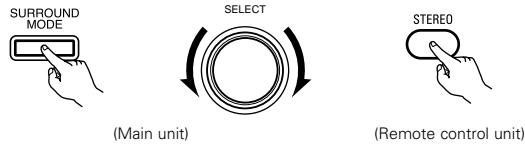

※ To select the surround mode while adjusting the surround parameters, channel volume or tone control, press the surround mode button then operate the selector.

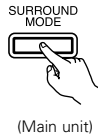

4 Start playback on the selected component.

- For operating instructions, refer to the component's manual.

5 Adjust the volume.

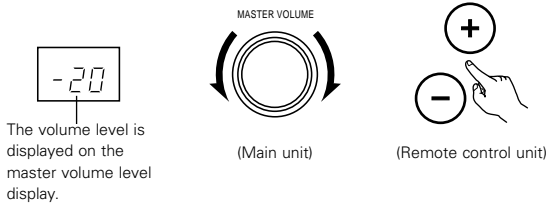

※ The volume can be adjusted within the range of -80 to 0 to 18 dB, in steps of 0.5 dB. However, when the channel level is set as described on page 21 or pages 49 and 50, if the volume for any channel is set at +1 dB or greater, the volume cannot be adjusted up to 18 dB. (In this case the maximum volume adjustment range is "18 dB — (Maximum value of channel level)".)

Input mode when playing DTS sources

- Noise will be output if DTS-compatible CDs or LDs are played in the "ANALOG" or "PCM" mode.
- When playing DTS-compatible sources, be sure to connect the source component to the digital input jacks (OPTICAL/COAXIAL) and set the input mode to "DTS".

Input mode display

- In the AUTO mode



- In the DIGITAL PCM mode

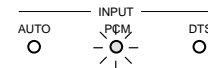

- In the DIGITAL DTS mode

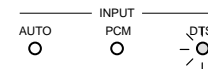

- In the ANALOG mode

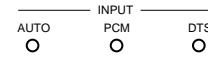

One of these lights, depending on the input signal.



Input signal display

- DOLBY DIGITAL

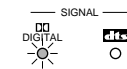

- DTS



- PCM



※ The **DIGITAL** indicator lights when digital signals are being input properly. If the **DIGITAL** indicator does not light, check whether the digital input component setup (page 23) and connections are correct and whether the component's power is turned on.

NOTE:

- The **DIGITAL** indicator will light when playing CD-ROMs containing data other than audio signals, but no sound will be heard.

Playback using the external input (EXT. IN) jacks

- 1** Set the external input (EXT. IN) mode.
Press the EXT. IN to switch the external input.

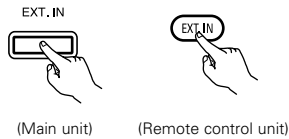

Once this is selected, the input signals connected to the FL (front left), FR (front right), C (center), SL (surround left), SR (surround right), SBL (surround back left) and SBR (surround back right) channels of the EXT. IN jacks are output directly to the front (left and right), center, surround (left and right) and surround back (left and right) speaker systems as well as the pre-out jacks without passing through the surround circuitry. In addition, the signal input to the SW (subwoofer) jack is output to the PRE OUT SUBWOOFER jack.

- 2** Cancelling the external input mode
To cancel the external input (EXT. IN) setting, press the input mode (AUTO, PCM, DTS) or ANALOG button to switch to the desired input mode. (See page 42.)

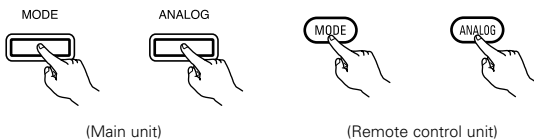

- When the input mode is set to the external input (EXT. IN), the surround mode (DIRECT, STEREO, DOLBY/DTS SURROUND, 5/7CH STEREO or DSP SIMULATION) cannot be set.

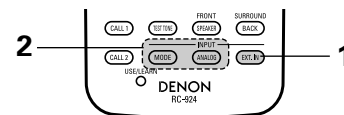
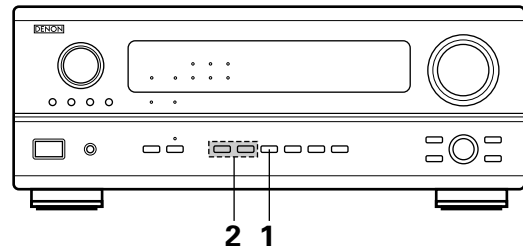

NOTES:

- In play modes other than the external input mode, the signals connected to these jacks cannot be played. In addition, signals cannot be output from channels not connected to the input jacks.
- The external input mode can be set for any input source. To watch video while listening to sound, select the input source to which the video signal is connected, then set this mode.

Playing audio sources (CDs and DVDs)

The AVR-2803/983 is equipped with two 2-channel playback modes exclusively for music. Select the mode to suit your tastes.

- 1 DIRECT mode**
Use this mode to achieve good quality 2-channel sound while watching images. In this mode, the audio signals bypass such circuits as the tone circuit and are transmitted directly, resulting in good quality sound.

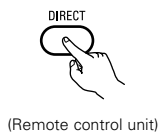

- 2 STEREO mode**
Use this mode to adjust the tone and achieve the desired sound while watching images.

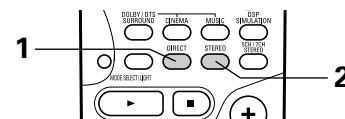
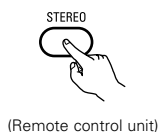

After starting playback

[1] Adjusting the sound quality (TONE)

- The tone control function will not work in the direct mode.
- The tone control setting only affects the front speakers.
- If the tone control function is used, the main volume cannot be adjusted up to 18 dB. (The maximum main volume level differs in the different surround modes.)

- 1** The tone switches as follows each time the TONE CONTROL button is pressed.

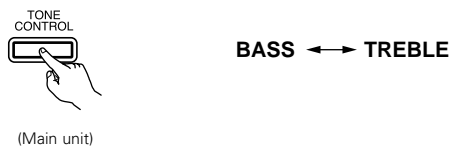

- 2** With the name of the volume to be adjusted selected, turn the SELECT knob to adjust the level.

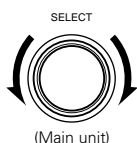

- To increase the bass or treble: Turn the control clockwise. (The bass or treble sound can be increased to up to +10 dB in steps of 2 dB.)
- To decrease the bass or treble: Turn the control clockwise. (The bass or treble sound can be decreased to up to -10 dB in steps of 2 dB.)

[2] Listening over headphones

- 1** Plug the headphones' plug into the jack.

- ※ Connect the headphones to the PHONES jack. The pre-out output (including the speaker output) is automatically turned off when headphones are connected.

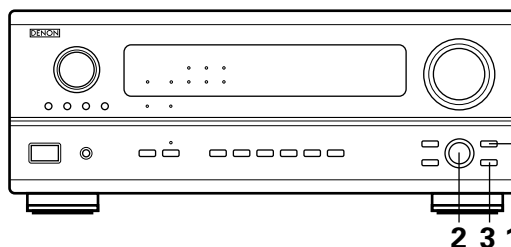

- 3** If you do not want the bass and treble to be adjusted, turn on the tone defeat mode.



- ※ The signals do not pass through the bass and treble adjustment circuits, providing higher quality sound.

[3] Turning the sound off temporarily (MUTING)

- 1** Use this to turn off the audio output temporarily. Press the MUTING button.

- ※ Cancelling MUTING mode. Press the MUTING button again or adjust the main volume level.

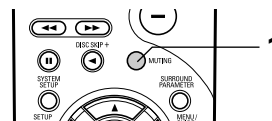
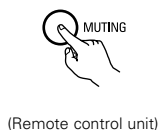

[4] Combining the currently playing sound with the desired image

- 1** Simulcast playback Use this switch to monitor a video source other than the audio source. Press the VIDEO SELECT button, turn the FUNCTION knob until the desired source appears on the display.

- ※ Cancelling simulcast playback.

- Select "SOURCE" using the VIDEO SELECT button and the FUNCTION knob.
- Switch the program source to the component connected to the video input.

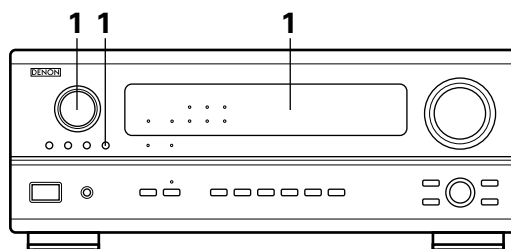
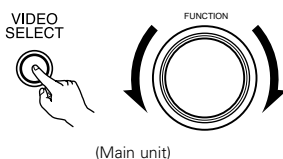

Display
IN=V SOURCE

NOTE:

To prevent hearing loss, do not raise the volume level excessively when using headphones.

[5] Checking the currently playing program source, etc.

- 1** On screen display
- Each time an operation is performed, a description of that operation appears on the display connected to the unit's VIDEO MONITOR OUT jack. Also, the unit's operating status can be checked during playback by pressing the remote control unit's ON SCREEN/DISPLAY button.

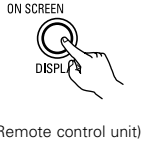

- Such information as the position of the input selector and the surround parameter settings is output in sequence.
- Front panel display
- Descriptions of the unit's operations are also displayed on the front panel display. In addition, the display can be switched to check the unit's operating status while playing a source by pressing the STATUS button.

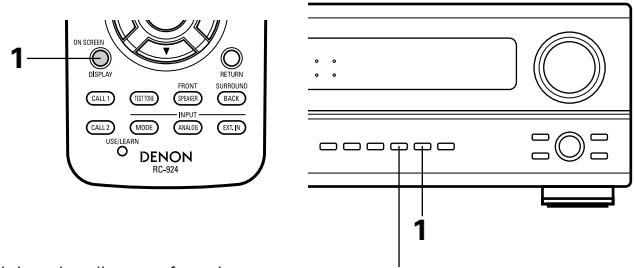
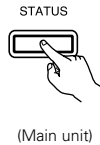

Using the dimmer function

- Use this to change the brightness of the display. The display brightness changes in four steps (bright, medium, dim and off) by pressing the main unit's DIMMER button repeatedly.



Multi-source recording/playback

[1] Playing one source while recording another (REC OUT mode)

- 1** Press the ZONE2/REC button.



- 2** With "RECOUT SOURCE" displayed, turn the FUNCTION knob to select the source you wish to record.
- The "REC" indicator and the indicator of the selected source light.

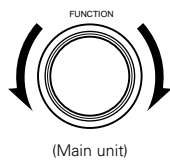

- 3** Set the recording mode.
- For operating instructions, refer to the manual of the component on which you want to record.

- 4** To cancel, turn the function knob and select "SOURCE".
- When "SOURCE" is selected, the "REC" indicator turns off.

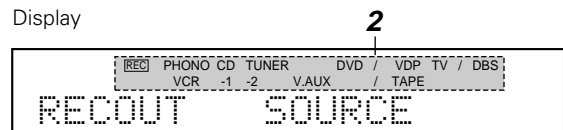
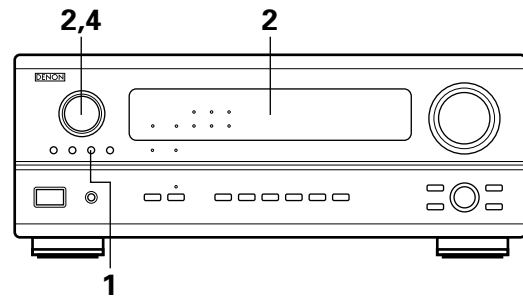
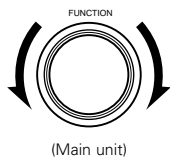

NOTES:

- Recording sources other than digital inputs selected in the REC OUT mode are also output to the Zone 2 preout jacks.
- Digital signals are not output from the REC SOURCE or audio output jacks.

[2] Outputting a program source to an amplifier, etc., in a different room (ZONE2 mode)

- 1** Press the ZONE2 button.

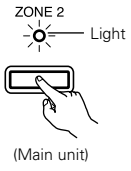

(Main unit)
- 2** Press the ZONE2/REC button. The display switches as follows each time the button is pressed.

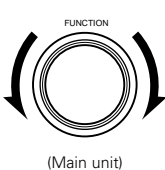

(Main unit)
- 3** With "ZONE2 SOURCE" displayed, turn the FUNCTION knob and select the source you wish to output.

 - The indicator of the selected source light.

(Main unit)
- 4** Start playing the source to be output.

 - For operating instructions, refer to the manuals of the respective components.
- 5** To cancel, turn the function knob and select "SOURCE".

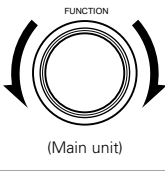

(Main unit)

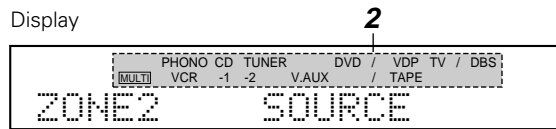
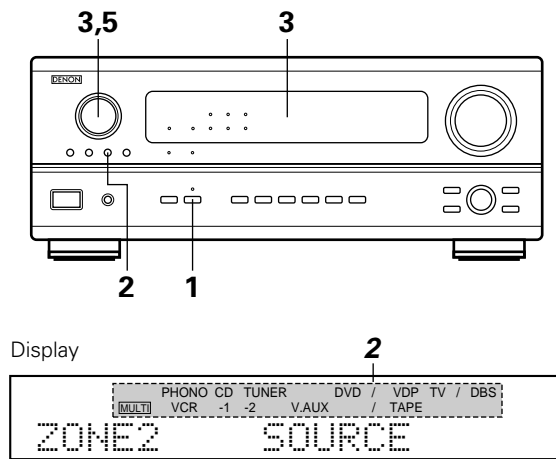

NOTES:

- The signals of the source selected in the ZONE2 mode are also output from the VCR-1, VCR-2 and CDR/TAPE recording output jacks.
- Digital signals are not output from the ZONE2 audio output jacks.

[3] Remote control unit operations during multi-source playback (selecting the input source)

This operation is possible when ZONE2 mode is selected.
This operation is not possible in the REC OUT mode.

- 1** Select "ZONE2" using the ZONE 2 button.

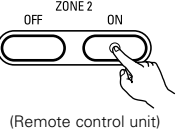

(Remote control unit)
- 2** Press the ZONE2 "ON" button.

 - ※ To cancel the ZONE2 mode. Press the ZONE2 "OFF" button.

(Remote control unit)
- 3** Press the input source button

 - The ZONE2 source switches directly.
- 4** The output level of the ZONE 2 OUT terminals can be controlled using the VOLUME + and - buttons on the remote control unit.

The output level of ZONE 2 OUT can be controlled only if ZONE2 vol. level is set "Variable" at Zone2 Control in System Setup Menu. (See page 26)

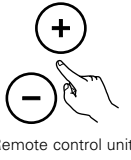
 - ※ DEFAULT SETTING (ZONE2 VOLUME LEVEL) : --- dB (MINIMUM)

(Remote control unit)

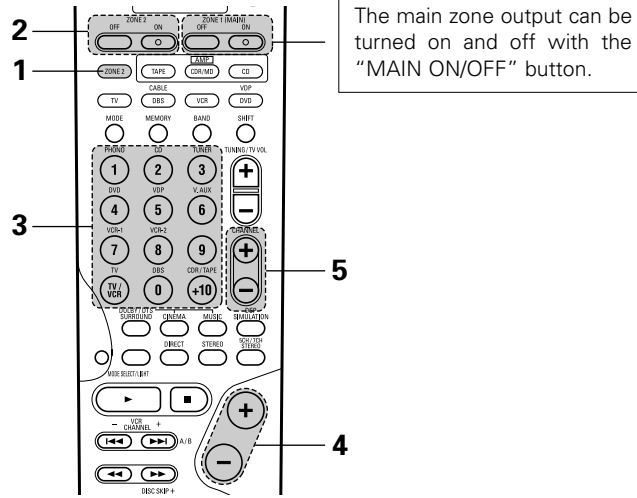

The main zone output can be turned on and off with the "MAIN ON/OFF" button.

- 5** When the ZONE2 SOURCE function is set to TUNER, the preset channel can be selected using the CHANNEL + and - buttons on the remote control unit.

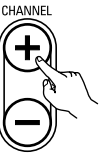

(Remote control unit)

Multi-zone playback with multi-source

MULTI ZONE MUSIC ENTERTAINMENT SYSTEM

- When the outputs of the “ZONE 2” OUT terminals are wired and connected to integrated amplifiers installed in other rooms, different sources can be played in rooms other than the main zone in which this unit and the playback devices are installed. (Refer to ZONE 2 on the diagram below.)
 - ZONE 2 SPEAKER OUT can be used when “ZONE2” is selected at System Setup Menu “Power Amp Assignment”. In this case, Surround Back Speaker Out cannot be used for MAIN ZONE. (See page 25.)
 - When a sold separately room-to-room remote control unit (DENON RC-616, 617 or 618) is wired and connected between the MAIN ZONE and ZONE 2, the remote-controllable devices in the main zone can be controlled from ZONE 2 using the remote control unit.
- ※ To control playback devices other than the ones above, either use that device’s remote control unit or preset a separately sold programmable remote control unit.

NOTES:

- For the AUDIO output, use high quality pin-plug cords and wire in such a way that there is no humming or noise.
- For instructions on installation and operation of separately sold devices, refer to the devices’ operating instructions.

■ MULTI ZONE MUSIC ENTERTAINMENT SYSTEM (When using PREOUT)

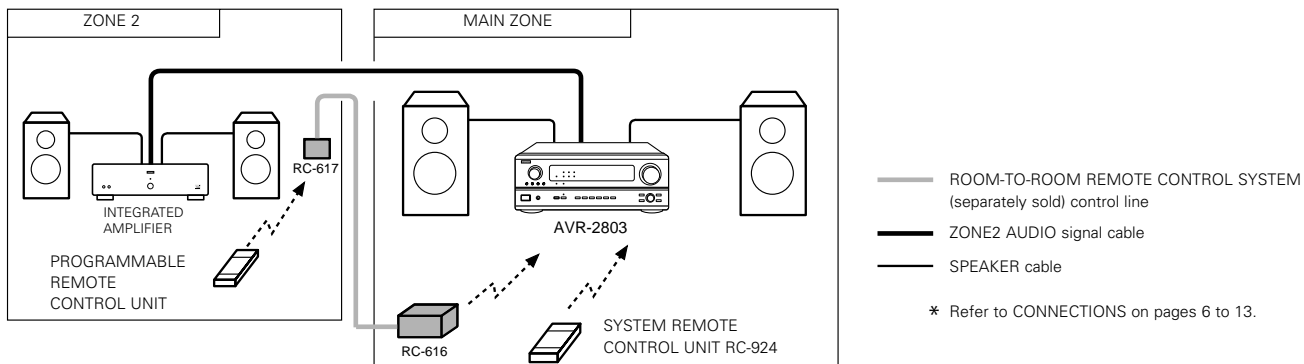

■ MULTI ZONE MUSIC ENTERTAINMENT SYSTEM (When using SPEAKER OUT)

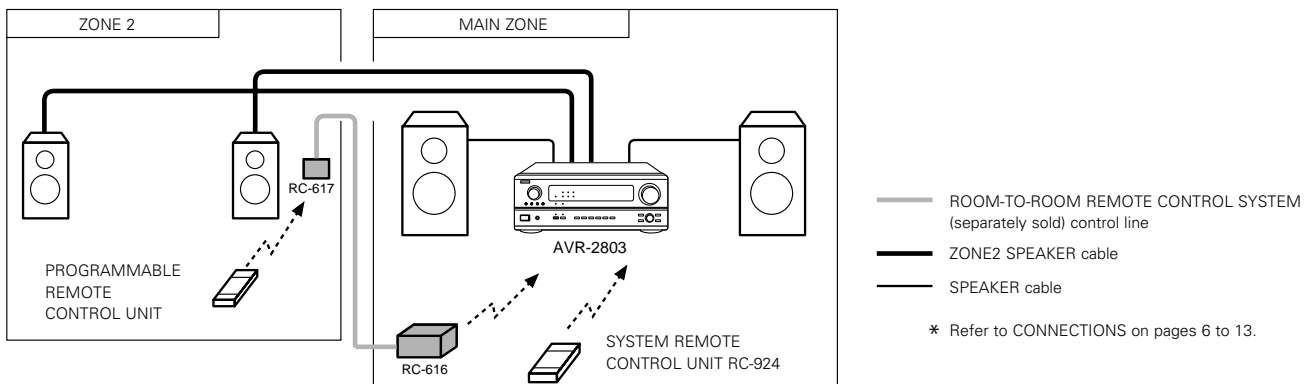



10 SURROUND

Before playing with the surround function

- Before playing with the surround function, be sure to use the test tones to adjust the playback level from the different speakers. This adjustment can be performed with the system setup (see page 21) or from the remote control unit, as described below.
- Adjusting with the remote control unit using the test tones is only possible in the "Auto" mode and only effective in the DOLBY/DTS SURROUND modes. The adjusted levels for the different modes are automatically stored in the memory.

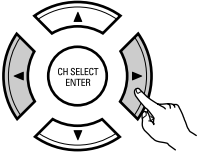
1  Press the TEST TONE button.
(Remote control unit)

2  Test tones are output from the different speakers. Use the channel volume adjust buttons to adjust so that the volume of the test tones is the same for all the speakers.
(Remote control unit)

3  After completing the adjustment, press the TEST TONE button again.
(Remote control unit)

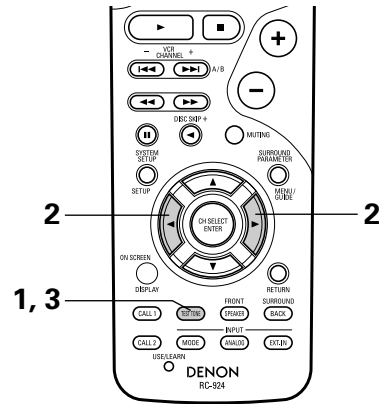

- After adjusting using the test tones, adjust the channel levels either according to the playback sources or to suit your tastes, as described below.

1  Select the speaker whose level you want to adjust.
(Remote control unit)
The channel switches as shown below each time the button is pressed.

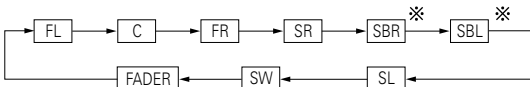

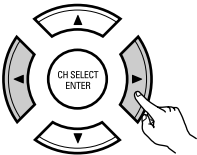
2  Adjust the level of the selected speaker.
(Remote control unit)

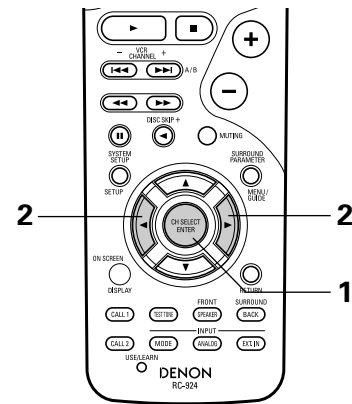

※ When the surround back speaker setting is set to "1spkr" for "Speaker Configuration", this is set to "SB".

NOTES:

- The adjustment range for the different channels is +12 dB to -12 dB.
- The sound from the subwoofer can be cut by lowering the SW (subwoofer) setting one step from -12 dB (setting it to "OFF").



Fader function

- This function makes it possible to lower the volume of the front channels (FL, C and FR) or the rear channels (SL, SR, SBL and SBR) together. Use it for example to adjust the balance of the sound from the different positions when playing multi-channel music sources.

1



Select "FADER".

(Remote control unit)

The channel switches in the order shown below each time this button is pressed.

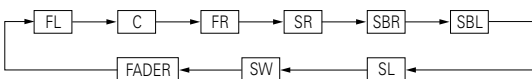

2

Press the ◀ button to reduce the volume of the front channels, the ▶ button to reduce the volume of the rear channels.

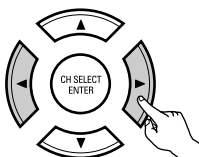

(Remote control unit)

※ The fader function does not affect the SW channel.

※ The channel whose channel level is adjusted lowest can be faded to -12 dB using the fader function.

※ If the channel levels are adjusted separately after adjusting the fader, the fader adjustment values are cleared, so adjust the fader again.

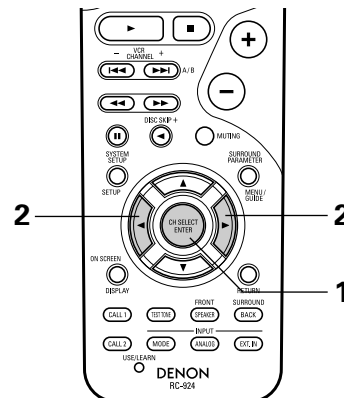

Fader		FRONT ◀ ▶ REAR
FL	0.0dB	
C	0.0dB	
FR	0.0dB	
SR	0.0dB	
SBR	0.0dB	
SBL	0.0dB	
SL	0.0dB	

This is only displayed when setting the fader control.

Dolby Surround Pro Logic II mode

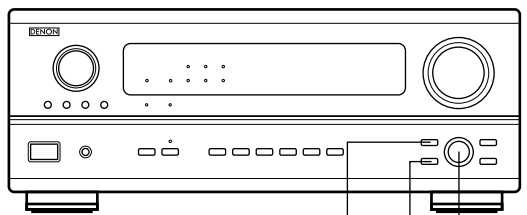

1 3, 5 1, 4, 6

1

Select the Dolby Surround Pro Logic II mode.

- The Dolby Pro Logic indicator lights.

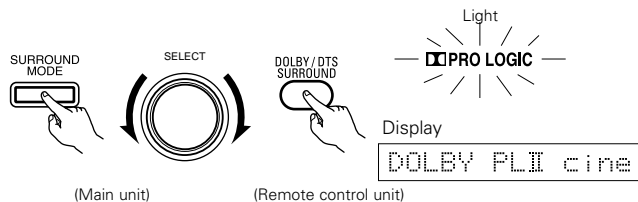

(Main unit)

(Remote control unit)

2

Play a program source with the DOLBY SURROUND mark.

- For operating instructions, refer to the manuals of the respective components.

1

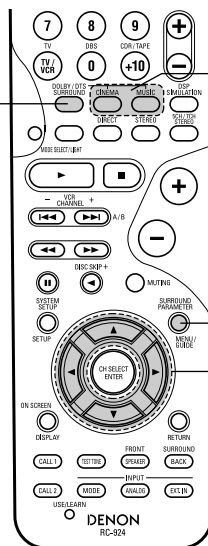

The Dolby Surround Pro Logic II Cinema or Music mode can be chosen directly by pressing the CINEMA or MUSIC button on the remote control unit during playback in the Dolby Surround Pro Logic II mode.

3

4, 5, 6

3 Set the surround parameter mode.

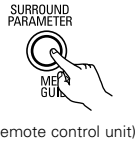
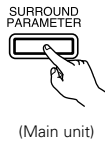

Display
MODE cinema

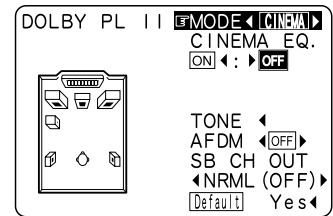

※ The on-screen display differs according to whether the operation is performed from the main unit or the remote control unit.

This is the screen when operated with the remote control unit.

4 Select the play mode.

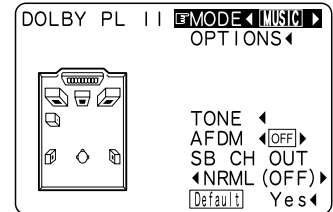
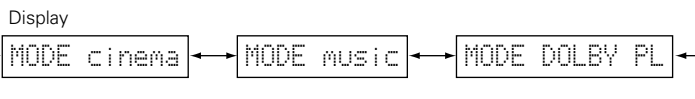
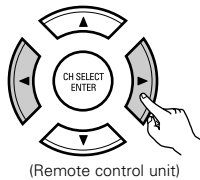
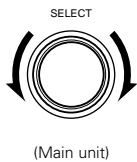

This is the screen when operated with the remote control unit.

5 Select the various parameters. (See "Surround parameters ①" for a description of the various parameters.)

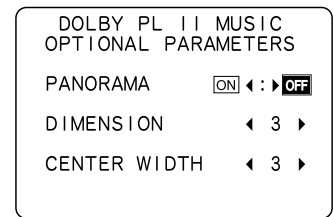
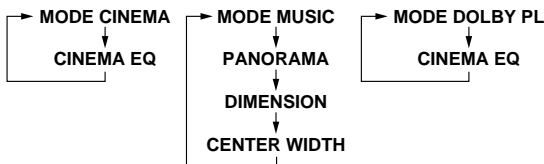
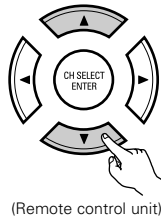

※ When set with the on-screen display using the remote control unit while in the MUSIC mode, set the "OPTION" mark to "OPTION" using the Δ and ∇ cursor buttons, then press the \triangleleft cursor button. Press the ENTER button to return to the previous screen.

6 Set the various surround parameters.

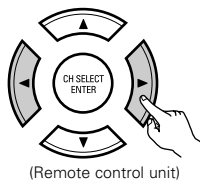
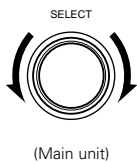

7 When the surround parameters are set using the buttons on the main unit, stop operating buttons after completing the settings. The settings are automatically finalized and the normal display reappears after several seconds.

When the settings are made using the buttons on the remote control unit, press the SURROUND PARAMETER button to finish.

NOTES:

- There are four Dolby Surround Pro Logic modes (NORMAL, PHANTOM, WIDE and 3 STEREO). The AVR-2803/983 sets the mode automatically according to the types of speakers set during the system setup process (page 18).
- Dolby Surround Pro Logic II is a mode in which 2-channel sources are expanded into 5.1 channels. To output a surround back channel in this mode, set the "SB CH OUT" surround parameter to "NON MTRX".

Surround parameters ①

Pro Logic II Mode:

The Cinema mode is for use with stereo television shows and all programs encoded in Dolby Surround.

The Music mode is recommended as the standard mode for autosound music systems (no video), and is optional for A/V systems.

The Dolby PL mode offers the same robust surround processing as original Pro Logic in case the source contents is not of optimum quality.

Select one of the modes ("Cinema", "Music" or "Dolby PL").

Panorama Control:

This mode extends the front stereo image to include the surround speakers for an exciting "wraparound" effect with side wall imaging.

Select "OFF" or "ON".

Dimension Control:

This control gradually adjust the soundfield either towards the front or towards the rear.

The control can be set in 7 steps from 0 to 6.

Center Width Control:

This control adjust the center image so it may be heard only from the center speaker; only from the left/right speakers as a phantom image; or from all three front speakers to varying degrees.

The control can be set in 8 steps from 0 to 7.

DTS NEO:6 mode

- Surround playback can be performed for the analog input and PCM digital input 2-channel signals.

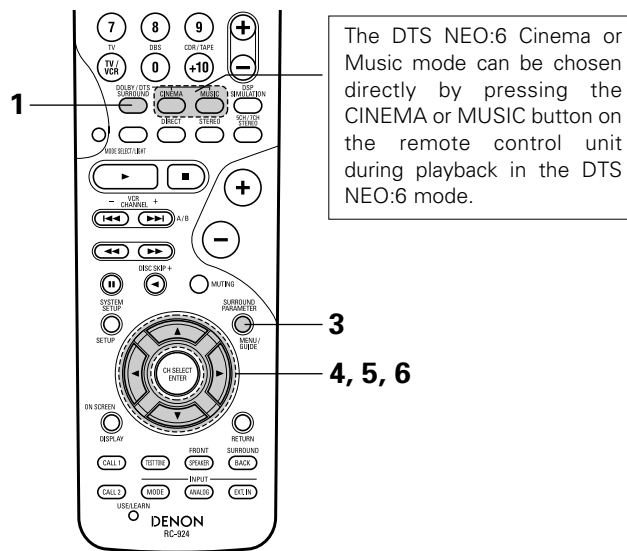
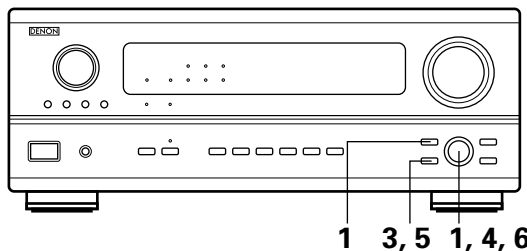

The DTS NEO:6 Cinema or Music mode can be chosen directly by pressing the CINEMA or MUSIC button on the remote control unit during playback in the DTS NEO:6 mode.

1 Select the DTS NEO:6 mode.

(Main unit) (Remote control unit)

2 Play a program source.

3 Set the surround parameter mode.

(Main unit) (Remote control unit)

This is the screen when operated with the remote control unit.

5 Select the various parameters. (See "Surround parameters ③" on page 59 for a description of the various parameters.)

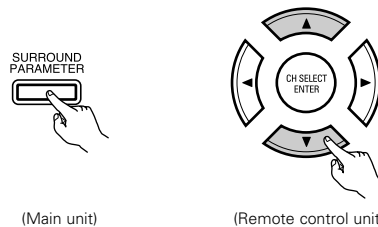

4 Select the play mode.

(Main unit) (Remote control unit)

This is the screen when operated with the remote control unit.

6 Set the various surround parameters.

(Main unit) (Remote control unit)

7 When the surround parameters are set using the buttons on the main unit, stop operating buttons after completing the settings. The settings are automatically finalized and the normal display reappears after several seconds.

When the settings are made using the buttons on the remote control unit, press the SURROUND PARAMETER button to finish.

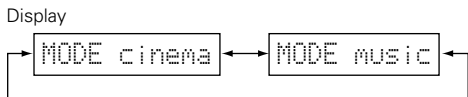

NOTE:

- When "Default" is selected and the ◀ cursor button is pressed, "MODE" and "TONE" are automatically reset to the default values and "CINEMA EQ" is set to "OFF".



Dolby Digital mode (only with digital input) and DTS Surround mode (only with digital input)

1 Select the input source.

Playback with a digital input

- ① Select an input source set to digital (COAXIAL/OPTICAL) (see page 23).

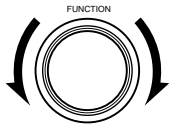

(Main unit)



(Remote control unit)

- ② Set the input mode to "AUTO" or "DTS".

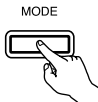

(Main unit)



(Remote control unit)

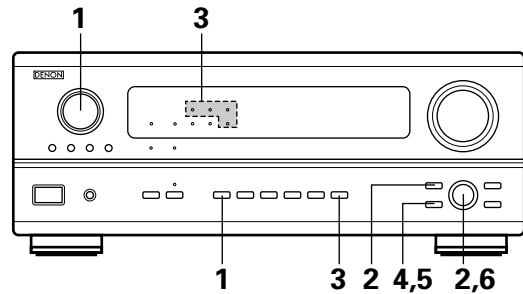

2 Select the Dolby/DTS Surround mode.



(Remote control unit)

When performing this operation from the main unit's panel, press the SURROUND MODE button, then turn the SELECT knob and select Dolby Pro logic II or DTS NEO:6.



(Main unit)

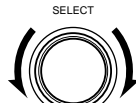

(Main unit)

3 Play a program source with the , mark.

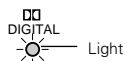

Light

- The Dolby Digital indicator lights when playing Dolby Digital sources.

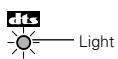

Light

- The DTS indicator lights when playing DTS sources.

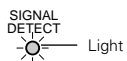

Light

- The SIGNAL DETECT LED lights when playing 6.1-channel surround sources containing the identification signal.

※ When the SIGNAL DETECT LED is lit, we recommend turning the surround back channel using the SURROUND BACK button on the remote control unit and main unit during playback.

※ To use DTS 96/24 sources with the optimum system, we recommend turning the surround back channel off.

Operate the SURROUND BACK button to switch Surround Back CH ON/OFF.



(Main unit)



(Remote control unit)

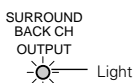

Light

- Lights when the Surround Back CH is on.

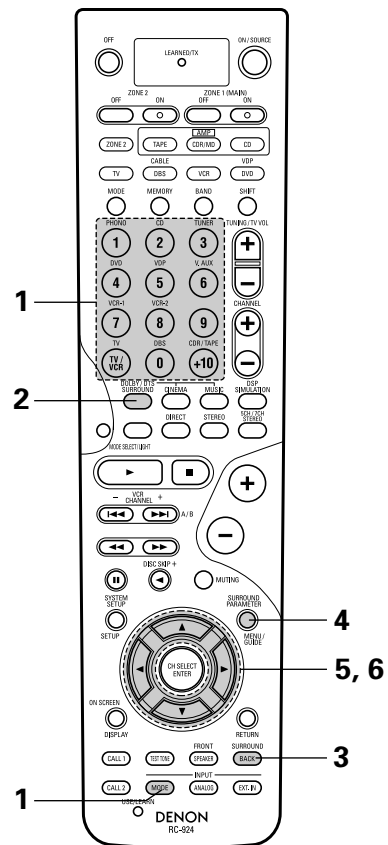

4

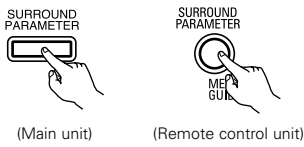

Display the surround parameter menu.

NOTE: The display on the screen differs depending on whether you are performing the operation from the main unit or the remote control unit.

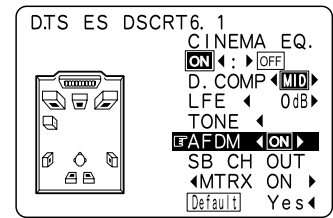
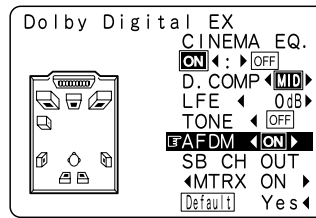

5

Select the various parameters.

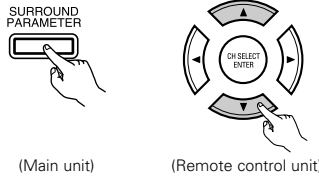

6

Adjust the parameter settings.

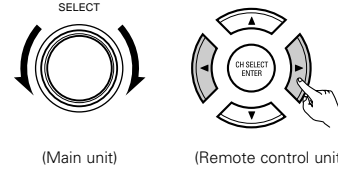

■ Dialogue Normalization

The dialogue normalization function is activated automatically when playing Dolby Digital program sources. Dialogue normalization is a basic function of Dolby Digital which automatically normalizes the dialog level (standard level) of the signals which are recorded at different levels for different program sources, such as DVD, DTV and other future formats that will use Dolby Digital. These contents can be verified with the STATUS button.

Display

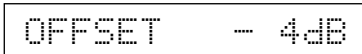

The number indicates the normalization level when the currently playing program is normalized to the standard level.

NOTE:

- When "Default" is selected and the ◀ cursor button is pressed, "CINEMA EQ." and "D.COMP." are automatically turned off, "LFE" is reset, and the tone is set to the default value.

Surround parameters ②

CINEMA EQ. (Cinema Equalizer):

The Cinema EQ function gently decreases the level of the extreme high frequencies, compensating for overly-bright sounding motion picture soundtracks. Select this function if the sound from the front speakers is too bright.

This function only works in the Dolby Pro Logic II, Dolby Digital, DTS Surround, DTS NEO:6 and WIDE SCREEN modes. (The same contents are set for all operating modes.)

D.COMP. (Dynamic Range Compression):

Motion picture soundtracks have tremendous dynamic range (the contrast between very soft and very loud sounds). For listening late at night, or whenever the maximum sound level is lower than usual, the Dynamic Range Compression allows you to hear all of the sounds in the soundtrack (but with reduced dynamic range). (This only works when playing program sources recorded in Dolby Digital or DTS.) Select one of the four parameters ("OFF", "LOW", "MID" (middle) or "HI" (high)). Set to OFF for normal listening.

LFE (Low Frequency Effect):

This sets the level of the LFE (Low Frequency Effect) sounds included in the source when playing program sources recorded in Dolby Digital or DTS. If the sound produced from the subwoofer sounds distorted due to the LFE signals when playing Dolby Digital or DTS sources when the peak limiter is turned off with the subwoofer peak limit level setting (system setup menu), adjust the level as necessary.

Program source and adjustment range:

1. Dolby Digital: -10 dB to 0 dB
2. DTS Surround: -10 dB to 0 dB

※ When DTS encoded movie software is played, it is recommended that the LFE LEVEL be set to 0 dB for correct DTS playback.

※ When DTS encoded music software is played, it is recommended that the LFE LEVEL be set to -10 dB for correct DTS playback.

TONE:

This adjusts the tone control. (See "Surround parameters ③" on page 59.)

SB CH OUT:

(1) Dolby Digital/DTS source

- "OFF"Playback is conducted without using the surround back speaker.
- "NON MTRX"Playback is conducted using the surround back speaker.
The same signals those of the surround channels are output from the surround back channels.
- "MTRX ON"Playback is conducted using the surround back speaker.
Surround back channel is reproduced using digital matrix processing.
- "NRML (OFF)"Playback is conducted without using the surround back speaker.
- "NRML (ON)"Playback is conducted using the surround back speaker.
The same signals those of the surround channels are output from the surround back channels.

(2) Other source

- "OFF"Playback is conducted without using the surround back speaker.
- "ON"Playback is conducted using the surround back speaker.

NOTE: This operation can be performed directly using the "SURROUND BACK" button on the main unit's panel.



11 DSP SURROUND SIMULATION

- The AVR-2803/983 is equipped with a high performance DSP (Digital Signal Processor) which uses digital signal processing to synthetically recreate the sound field. One of seven preset surround modes can be selected according to the program source and the parameters can be adjusted according to the conditions in the listening room to achieve a more realistic, powerful sound. These surround modes can also be used for program sources not recorded in Dolby Surround Pro Logic, Dolby Digital or DTS.

Surround modes and their features

1	ROCK ARENA	Use this mode to achieve the feeling of a live concert in an arena with reflected sounds coming from all directions.
2	JAZZ CLUB	This mode creates the sound field of a live house with a low ceiling and hard walls. This mode gives jazz a very vivid realism.
3	MONO MOVIE (NOTE 1)	Select this when watching monaural movies for a greater sense of expansion.
4	VIDEO GAME	Use this to enjoy video game sources.
5	MATRIX	Select this to emphasize the sense of expansion for music sources recorded in stereo. Signals consisting of the difference component of the input signals (the component that provides the sense of expansion) processed for delay are output from the surround channel.
6	VIRTUAL	Select this mode to enjoy a virtual sound field, produced from the front 2-channel speakers.
7	5CH/7CH STEREO	The front left channel signals are output to the surround and surround back signal left channels, the front right channel signals are output to the surround and surround back signal right channels, and the in-phase component of the left and right channels is output to the center channel. Use this mode to enjoy stereo sound.

- ※ Depending on the program source being played, the effect may not be very noticeable.
In this case, try other surround modes, without worrying about their names, to create a sound field suited to your tastes.

NOTE 1: When playing sources recorded in monaural, the sound will be one-sided if signals are only input to one channel (left or right), so input signals to both channels. If you have a source component with only one audio output (monophonic camcorder, etc.) obtain a "Y" adaptor cable to split the mono output to two outputs, and connect to the L and R inputs.

Personal Memory Plus

This set is equipped with a personal memorize function that automatically memorizes the surround modes and input modes selected for the input different sources. When the input source is switched, the modes set for that source last time it was used are automatically recalled.

- ※ The surround parameters, tone control settings and playback level balance for the different output channels are memorized for each surround mode.

DSP surround simulation

- To operate the surround mode and surround parameters from the remote control unit.

1 Select the surround mode for the input channel.



(Remote control unit)

The surround mode switches in the following order each time the DSP SIMULATION button is pressed:

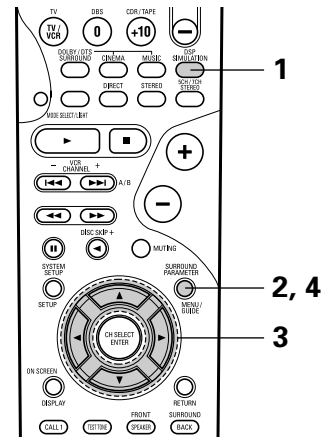
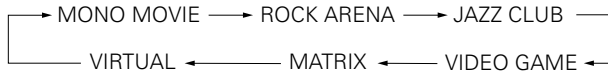

2 (Remote control unit)

Display the surround parameter screen on the monitor.
 ※ The screen for the selected surround mode appears.

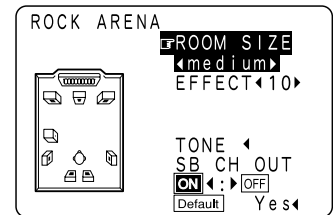

3 (Remote control unit)

Set the parameters.

4 (Remote control unit)

To end the setting mode, press the surround parameter button again.

NOTES:

- When "Default" is selected and the ◀ cursor button is pressed, "CINEMA EQ." and "D.COMP." are automatically turned off, "ROOM SIZE" is set to "medium", "EFFECT LEVEL" to "10", "DELAY TIME" to "30ms" and "LFE" to "0dB".
- The "ROOM SIZE" expresses the expansion effect for the different surround modes in terms of the size of the sound field, not the actual size of the listening room.

- Operating the surround mode and surround parameters from the main unit's panel.

1 Turn the SELECT knob to select the surround mode.

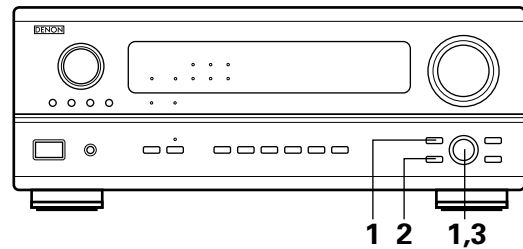
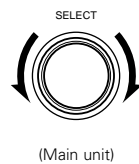

- When turned clockwise

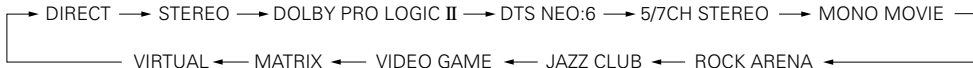

- When turned counterclockwise

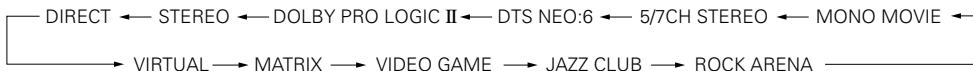

※ To select the surround mode while adjusting the surround parameters or tone control, press the surround mode button then operate the selector.



(Main unit)

2 Press the SURROUND PARAMETER button.
Press and hold in the surround parameter button to select the parameter you want to set.

- The parameters which can be set differ for the different surround modes. (Refer to "Surround Modes and Parameters" on page 60.)



(Main unit)

3 Display the parameter you want to adjust, then turn the SELECT knob to set it.

NOTE:

- When playing PCM digital signals or analog signals in the DOLBY PRO LOGIC II, DTS NEO:6 modes and the input signal switches to a digital signal encoded in Dolby Digital, the Dolby surround mode switches automatically. When the input signal switches to a DTS signal, the mode automatically switches to DTS surround.

Tone control setting

- Use the tone control setting to adjust the bass and treble as desired.
- To operate the tone control from the remote control unit.
- The tone control setting only affects the front speakers.
- If the tone control function is used, the main volume cannot be adjusted up to 18 dB. (The maximum main volume level differs in the different surround modes.)

1



(Remote control unit)

Display the surround parameter screen on the monitor.

※ The screen for the selected surround mode appears. "TONE" cannot be selected in the Direct mode.

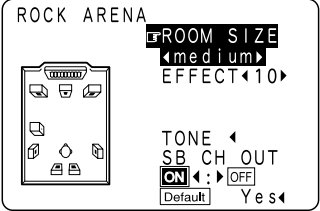

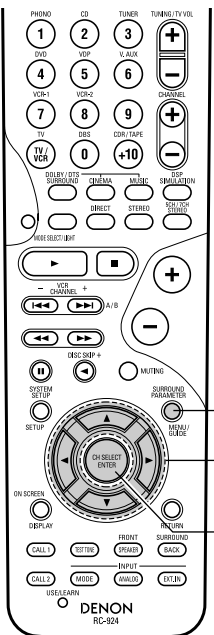

2

Select "TONE".

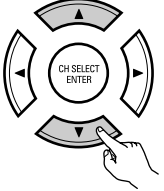

(Remote control unit)

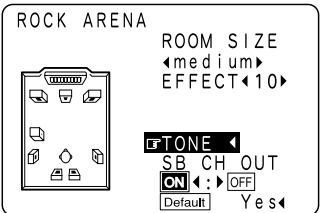

3

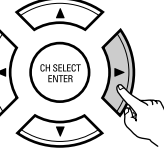

(Remote control unit)

Switch to the Tone Control screen.

Select Tone Defeat OFF.

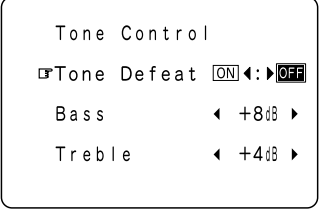

4

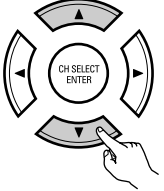

(Remote control unit)

To select Bass or Treble.

To set the level.

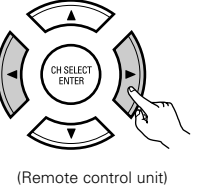

(Remote control unit)

5



(Remote control unit)

Enter the setting.

The surround menu screen re-appears.

6



(Remote control unit)

To end the setting mode, press the surround parameter button again.

- To operate the tone control from the main unit.

1 The tone switches as follows each time the TONE CONTROL button is pressed.



BASS ← → TREBLE

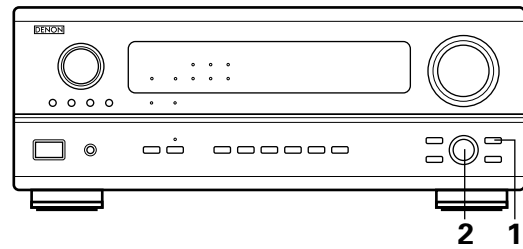

2

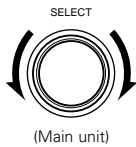

With the name of the volume to be adjusted selected, turn the SELECT knob to adjust the level.

- To increase the bass or treble:
Turn the control clockwise. (The bass or treble sound can be increased to up to +10 dB in steps of 2 dB.)
- To decrease the bass or treble:
Turn the control clockwise. (The bass or treble sound can be decreased up to -10 dB in steps of 2 dB.)

Surround parameters ③

MODE: (DTS NEO:6)

• Cinema

This mode is optimum for playing movies. Decoding is performed with emphasis on separation performance to achieve the same atmosphere with 2-channel sources as with 6.1-channel sources.

This mode is effective for playing sources recorded in conventional surround formats as well, because the in-phase component is assigned mainly to the center channel (C) and the reversed phase component to the surround (SL, SR and SB channels).

• Music

This mode is suited mainly for playing music. The front channel (FL and FR) signals bypass the decoder and are played directly so there is no loss of sound quality, and the effect of the surround signals output from the center (C) and surround (SL, SR and SB) channels add a natural sense of expansion to the sound field.

ROOM SIZE:

This sets the size of the sound field.

There are five settings: "small", "med.s" (medium-small), "medium", "med.l" (medium-large) and "large". "small" recreates a small sound field, "large" a large sound field.

EFFECT LEVEL:

This sets the strength of the surround effect.

The level can be set in 15 steps from 1 to 15. Lower the level if the sound seems distorted.

DELAY TIME:

In the matrix mode only, the delay time can be set within the range of 0 to 300 ms.

TONE CONTROL:

This can be set individually for the separate surround modes other than Direct.

However, the same contents are set for DOLBY/DTS modes.

■ Surround modes and parameters

Mode	Signals and adjustability in the different modes								
	Channel output					When playing Dolby Digital signals	When playing DTS signals	When playing PCM signals	When playing ANALOG signals
	FRONT L/R	CENTER	SURROUND L/R	SUB-WOOFER	SURROUND BACK L/R				
DIRECT	○	×	×	⊗	×	○	○	○	○
STEREO	○	×	×	⊗	×	○	○	○	○
EXTERNAL INPUT	○	⊗	⊗	⊗	⊗	×	×	×	○
DOLBY PRO LOGIC II	○	⊗	⊗	⊗	⊗ *2	○ *1	×	○	○
DTS NEO:6	○	⊗	⊗	⊗	⊗	○ *1	×	○	○
DOLBY DIGITAL	○	⊗	⊗	⊗	⊗	○	×	×	×
DTS SURROUND (DTS ES MTRX 6.1)	○	⊗	⊗	⊗	⊗	×	○	×	×
5/7CH STEREO	○	⊗	⊗	⊗	⊗	○	○	○	○
ROCK ARENA	○	⊗	⊗	⊗	⊗	○	○	○	○
JAZZ CLUB	○	⊗	⊗	⊗	⊗	○	○	○	○
VIDEO GAME	○	⊗	⊗	⊗	⊗	○	○	○	○
MONO MOVIE	○	⊗	⊗	⊗	⊗	○	○	○	○
MATRIX	○	⊗	⊗	⊗	⊗	○	○	○	○
VIRTUAL	○	×	×	⊗	×	○	○	○	○

○ : Signal
 × : No signal
 ⊗ : Turned on or off by speaker configuration setting

○ : Able
 × : Unable

*1 Only for 2 ch contents.
 *2 Signal output can be changed with the "SB CH OUT" surround parameter setting.

Mode	Signals and adjustability in the different modes												
	Parameter (default values are shown in parentheses)												When playing Dolby Digital/DTS signals
	SURROUND PARAMETER							PRO LOGIC II MUSIC MODE ONLY			NEO:6 MUSIC MODE ONLY		
	TO NE CONTROL	MODE	CINEMA EQ.	ROOM SIZE	EFFECT LEVEL	DELAY TIME	SURROUND BACK	PANORAMA	DIMENSION	CENTER WIDTH	CENTER IMAGE	D. COMP	
DIRECT	×	×	×	×	×	×	×	×	×	×	×	○ (OFF)	○ (0dB)
STEREO	○ (0dB)	×	×	×	×	×	×	×	×	×	×	○ (OFF)	○ (0dB)
EXTERNAL INPUT	×	×	×	×	×	×	×	×	×	×	×	×	×
DOLBY PRO LOGIC II	○ (0dB)	○ (CINEMA)	○ (OFF) (Note2)	×	×	×	○ (NRML (OFF))	○ (OFF)	○ (3)	○ (3)	×	○ (OFF)	○ (0dB)
DTS NEO:6	○ (0dB)	○ (CINEMA)	○ (OFF) (Note3)	×	×	×	○ (NRML (ON))	×	×	×	○ (0.2)	○ (OFF)	○ (0dB)
DOLBY DIGITAL	○ (0dB)	×	○ (OFF)	×	×	×	○ (MTRX ON)	×	×	×	×	○ (OFF)	○ (0dB)
DTS SURROUND (DTS ES MTRX 6.1)	○ (0dB)	×	○ (OFF)	×	×	×	○ (MTRX ON)	×	×	×	×	○ (OFF)	○ (0dB)
5/7CH STEREO	○ (0dB)	×	×	×	×	×	○	×	×	×	×	○ (OFF)	○ (0dB)
ROCK ARENA	○ (Note1)	×	×	○ (Medium)	○ (10)	×	○	×	×	×	×	○ (OFF)	○ (0dB)
JAZZ CLUB	○ (0dB)	×	×	○ (Medium)	○ (10)	×	○	×	×	×	×	○ (OFF)	○ (0dB)
VIDEO GAME	○ (0dB)	×	×	○ (Medium)	○ (10)	×	○	×	×	×	×	○ (OFF)	○ (0dB)
MONO MOVIE	○ (0dB)	×	×	○ (Medium)	○ (10)	×	○	×	×	×	×	○ (OFF)	○ (0dB)
MATRIX	○ (0dB)	×	×	×	×	○ (30msec)	○	×	×	×	×	○ (OFF)	○ (0dB)
VIRTUAL	○ (0dB)	×	×	×	×	×	×	×	×	×	×	○ (OFF)	○ (0dB)

(Note 1) BASS: +8 dB, TREBLE: 4 dB
 (Note 2) Cinema, DOLBY PL Mode only
 (Note 3) Cinema Mode only

○ : Adjustable
 × : Not adjustable

12 LISTENING TO THE RADIO

- Check that the remote control unit is set to AMP mode (TAPE, CDR/MD or CD).

Auto tuning

- 1** Set the input function to "TUNER".

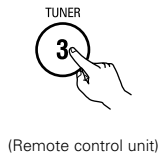
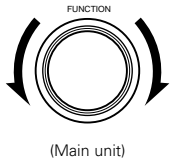

- 2** Watching the display, press the BAND button to select the desired band (AM or FM).

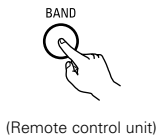

- 3** Press the MODE button to set the auto tuning mode.
- "Auto" appears on the display.

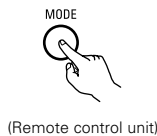

- 4** Press the TUNING + (up) or - (down) button.
- Automatic searching begins, then stops when a station is tuned in.

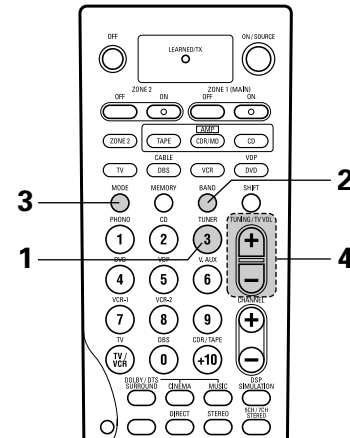
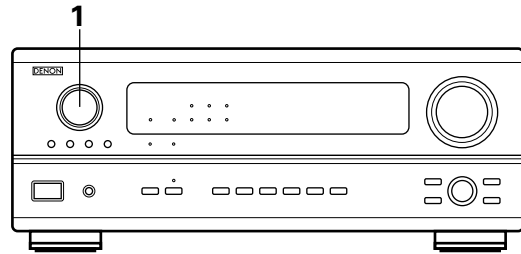

If tuning does not stop at the desired station, use to the "Manual tuning" operation.

Manual tuning

- 1** Set the input function to "TUNER".

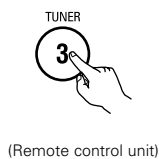
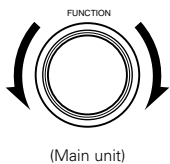

- 2** Watching the display, press the BAND button to select the desired band (AM or FM).

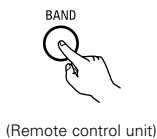

- 3** Press the MODE button to set the manual tuning mode.
- Check that the display's "AUTO" indicator turns off.

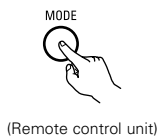

- 4** Press the TUNING + (up) or - (down) button to tune in the desired station.
- The frequency changes continuously when the button is held in.



NOTES:

- When in the auto tuning mode on the FM band, the "STEREO" indicator lights on the display when a stereo broadcast is tuned in. At open frequencies, the noise is muted and the "TUNED" and "STEREO" indicators turn off.
- When the manual tuning mode is set, FM stereo broadcasts are received in monaural and the "STEREO" indicator turns off.

Preset memory

1 Use the “Auto tuning” or “Manual tuning” operation to tune in the station to be preset in the memory.

2 Press the MEMORY button.



(Remote control unit)

3 Press the SHIFT button and select the desired memory block (A to E).



(Remote control unit)

4 Press the CHANNEL + (up) or – (down) button to select the desired preset channel (1 to 8).



(Remote control unit)

5 Press the MEMORY button again to store the station in the preset memory.



(Remote control unit)

To preset other channels, repeat steps 2 to 5.
A total of 40 broadcast stations can be preset — 8 stations (channels 1 to 8) in each of blocks A to E.

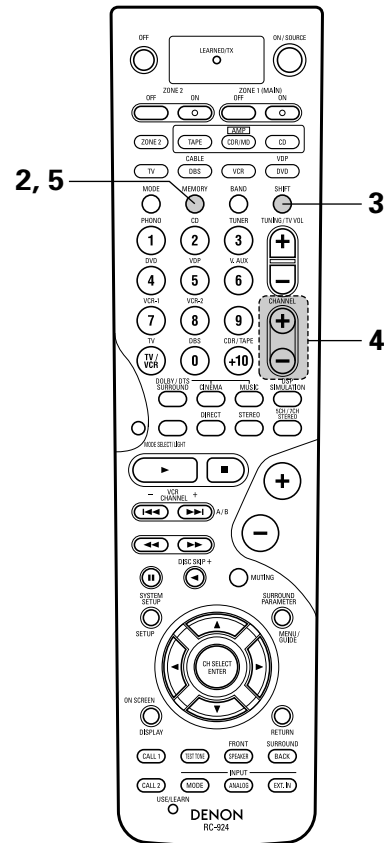

Checking the preset stations

- The preset (broadcast) stations can be checked on the on screen display.

1 Press the ON SCREEN/DISPLAY button repeatedly until the “Tuner Preset Stations” screen appears on the OSD.

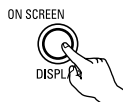

(Remote control unit)

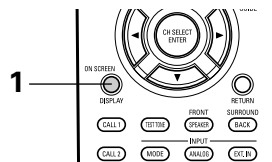

Tuner Preset Stations	
A1FM	87.50MHz
A2FM	89.10MHz
A3FM	98.10MHz
A4FM	107.90MHz
A5FM	90.10MHz
A6FM	90.10MHz
A7FM	90.10MHz
A8FM	90.10MHz

OSD-3

Recalling preset stations

- Recalling preset stations from the remote control unit.

1  Watching the display, press the SHIFT button to select the preset memory block.

(Remote control unit)

2  Watching the display, press the CHANNEL + (up) or - (down) button to select the desired preset channel.

(Remote control unit)

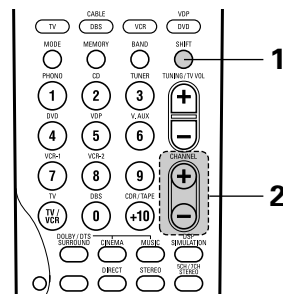

- Recalling preset stations from the main unit's panel.

1  Press the TUNING PRESET button.

(Main unit)

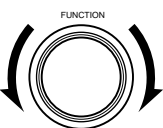
2  Turn the FUNCTION knob and select the desired preset channel.

(Main unit)

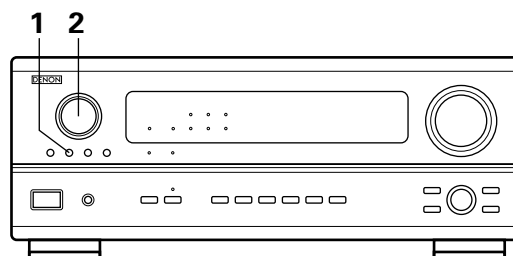

13 LAST FUNCTION MEMORY

- This unit is equipped with a last function memory which stores the input and output setting conditions as they were immediately before the power is switched off. This function eliminates the need to perform complicated resettings when the power is switched on.
- The unit is also equipped with a back-up memory. This function provides approximately one week of memory storage from when the main unit's power switch is off and with the power cord disconnected.

14 INITIALIZATION OF THE MICROPROCESSOR

When the indication of the display is not normal or when the operation of the unit does not shows the reasonable result, the initialization of the microprocessor is required by the following procedure.

1 Switch off the unit and remove the AC cord from the wall outlet.

2 Hold the following FRONT SPEAKER button and ZONE 2 button, and plug the AC cord into the wall outlet.

3 Check that the entire display is flashing with an interval of about 1 second, and release your fingers from the 2 buttons and the microprocessor will be initialized.

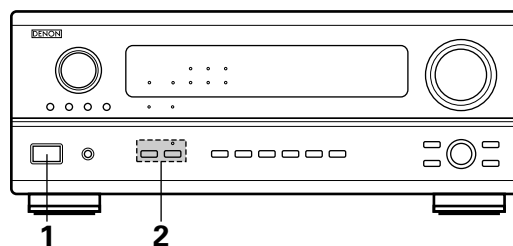

NOTES:

- If step 3 does not work, start over from step 1.
- If the microprocessor has been reset, all the settings are reset to the default values (the values set upon shipment from the factory).

15 TROUBLESHOOTING

If a problem should arise, first check the following table.

1. Are the connections correct ?

2. Have you operated the receiver according to the Operating Instructions ?

3. Are the speakers, turntable and other components operating properly ?

If this unit is not operating properly, check the items listed in the table below. Should the problem persist, there may be a malfunction. Disconnect the power immediately and contact your store of purchase.

	Symptom	Cause	Measures	Page
Common problems when listening to the CD's, Records, Tapes and FM broadcasts, etc.	DISPLAY not lit and sound not produced when power switch set to on.	<ul style="list-style-type: none"> Power cord not plugged in securely. 	<ul style="list-style-type: none"> Check the insertion of the power cord plug. Turn the power on with the remote control unit after turning the POWER switch on. 	6 41
	DISPLAY lit but sound not produced.	<ul style="list-style-type: none"> Speaker cords not securely connected. Improper position of the audio function button. Volume control set to minimum. MUTING is on. Digital signals not input Digital input selected. 	<ul style="list-style-type: none"> Connect securely. Set to a suitable position. Turn volume up to suitable level. Switch off MUTING. Input digital signals or select input jacks to which digital signals are being input. 	12 42 43 45 42
	DISPLAY not lit and power indicator is flashing rapidly.	<ul style="list-style-type: none"> Speaker terminals are short-circuited. Block the ventilation holes of the set. The unit is operating at continuous high power conditions and/or inadequate ventilation. 	<ul style="list-style-type: none"> Switch power off, connect speakers properly, then switch power back on. Turn off the set's power, then ventilate it well to cool it down. Once the set is cooled down, turn the power back on. Turn off the set's power, then ventilate it well to cool it down. Once the set is cooled down, turn the power back on. 	12 4, 13 4, 13
	Sound produced only from one channel.	<ul style="list-style-type: none"> Incomplete connection of speaker cords. Incomplete connection of input/output cords. 	<ul style="list-style-type: none"> Connect securely. Connect securely. 	12 6 ~ 13
	Positions of instruments reversed during stereo playback.	<ul style="list-style-type: none"> Reverse connections of left and right speakers or left and right input/output cords. 	<ul style="list-style-type: none"> Check left and right connections. 	12
	The on screen display is not displayed.	<ul style="list-style-type: none"> "On screen display" is set to off on the system setup menu screen. 	<ul style="list-style-type: none"> Set "on screen display" on the system setup menu screen to on. 	27
	System setup screen does not appear	<ul style="list-style-type: none"> You are using headphones. Mute mode is set. Monitor TV not connected to AVR-2803/983. 	<ul style="list-style-type: none"> Unplug the headphones from the headphones jack. Cancel the mute mode. Connect a monitor TV. 	45 45 7, 8
When playing Records	Humming noise produced when Record is playing.	<ul style="list-style-type: none"> Ground wire of turntable not connected properly. Incomplete PHONO jack connection. TV or radio transmission antenna nearby. 	<ul style="list-style-type: none"> Connect securely. Connect securely. Contact your store of purchase. 	6 6 —
	Howling noise produced when volume is high.	<ul style="list-style-type: none"> Turntable and speaker systems too close together. Floor is unstable and vibrates easily. 	<ul style="list-style-type: none"> Separate as much as possible. Use cushions to absorb speaker vibrations transmitted by floor. If turntable is not equipped with insulators, use audio insulators (commonly available). 	— —
	Sound is distorted.	<ul style="list-style-type: none"> Stylus pressure too weak. Dust or dirt on stylus. Cartridge defective. 	<ul style="list-style-type: none"> Apply proper stylus pressure. Check stylus. Replace cartridge. 	— — —
	Volume is weak.	<ul style="list-style-type: none"> MC cartridge being used. 	<ul style="list-style-type: none"> Replace with MM cartridge or use a head amplifier or step-up transformer. 	6
Remote control unit	This unit does not operate properly when remote control unit is used.	<ul style="list-style-type: none"> Batteries dead. Remote control unit too far from this unit. Obstacle between this unit and remote control unit. Different button is being pressed. ⊕ and ⊖ ends of battery inserted in reverse. 	<ul style="list-style-type: none"> Replace with new batteries. Move closer. Remove obstacle. Press the proper button. Insert batteries properly. 	31 31 31 — 31

16 ADDITIONAL INFORMATION

Optimum surround sound for different sources

There are currently various types of multi-channel signals (signals or formats with more than two channels).

■ Types of multi-channel signals

Dolby Digital, Dolby Pro Logic, DTS, high definition 3-1 signals (Japan MUSE Hi-Vision audio), DVD-Audio, SACD (Super Audio CD), MPEG multi-channel audio, etc.

“Source” here does not refer to the type of signal (format) but the recorded content. Sources can be divided into two major categories.

■ Types of sources

• Movie audio

Signals created to be played in movie theaters. In general sound is recorded to be played in movie theaters equipped with multiple surround speakers, regardless of the format (Dolby Digital, DTS, etc.).

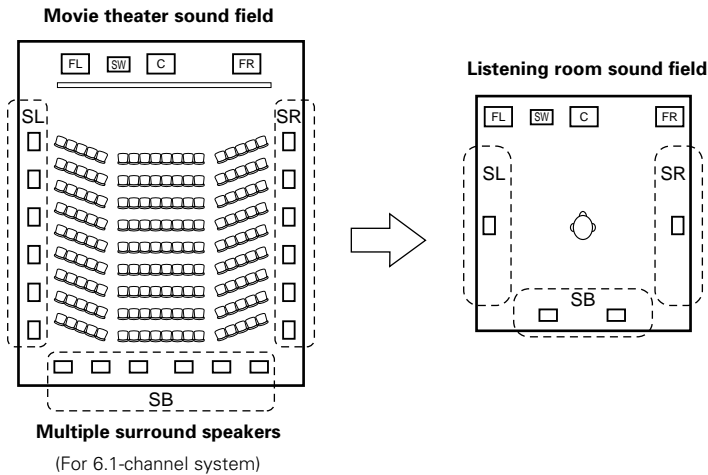

In this case it is important to achieve the same sense of expansion as in a movie theater with the surround channels. To do so, in some cases the number of surround speakers is increased (to four or eight) or speakers with bipolar or dipolar properties are used.

(SL: Surround L channel
SR: Surround R channel
SB: Surround back channel)

• Other types of audio

These signals are designed to recreate a 360° sound field using three to five speakers.

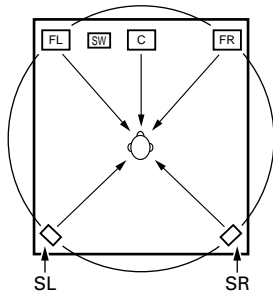

In this case the speakers should surround the listener from all sides to create a uniform sound field from 360°. Ideally the surround speakers should function as “point” sound sources in the same way as the front speakers.

These two types of sources thus have different properties, and different speaker settings, particularly for the surround speakers, are required in order to achieve the ideal sound.

Surround back speakers

A 6.1-channel system is a conventional 5.1-channel system to which the “surround back” (SB) channel has been added. This makes it easy to achieve sound positioned directly behind the listener, something that was previously difficult with sources designed for conventional multi surround speakers. In addition, the acoustic image extending between the sides and the rear is narrowed, thus greatly improving the expression of the surround signals for sounds moving from the sides to the back and from the front to the point directly behind the listening position.

Change of positioning and acoustic image with 5.1-channel systems

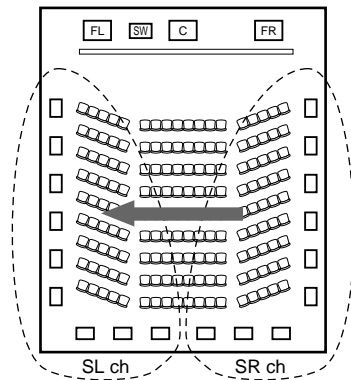

Movement of acoustic image from SR to SL

Change of positioning and acoustic image with 6.1-channel systems

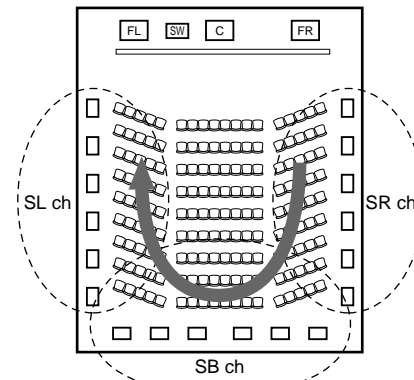

Movement of acoustic image from SR to SB to SL

With this set, speaker(s) for 1 or 2 channels are required to achieve a 6.1-channel system (DTS-ES, etc.). Adding these speakers, however, increases the surround effect not only with sources recorded in 6.1 channels but also with conventional 2- to 5.1-channel sources. The WIDE SCREEN mode is a mode for achieving surround sound with up to 7.1 channels using surround back speakers, for sources recorded in conventional Dolby Surround as well as Dolby Digital 5.1-channel and DTS Surround 5.1-channel sources. Furthermore, all the Denon original surround modes (see page 55) are compatible with 7.1-channel playback, so you can enjoy 7.1-channel sound with any signal source.

■ Number of surround back speakers

Though the surround back channel only consists of 1 channel of playback signals for 6.1-channel sources (DTS-ES, etc.), we recommend using two speakers. When using speakers with dipolar characteristics in particular, it is essential to use two speakers.

Using two speakers results in a smoother blend with the sound of the surround channels and better sound positioning of the surround back channel when listening from a position other than the center.

■ Placement of the surround left and right channels when using surround back speakers

Using surround back speakers greatly improves the positioning of the sound at the rear. Because of this, the surround left and right channels play an important role in achieving a smooth transition of the acoustic image from the front to the back. As shown on the diagram above, in a movie theater the surround signals are also produced from diagonally in front of the listeners, creating an acoustic image as if the sound were floating in space.

To achieve these effects, we recommend placing the speakers for the surround left and right channels slightly more towards the front than with conventional surround systems. Doing so sometimes increases the surround effect when playing conventional 5.1-channel sources in the 6.1 surround or DTS-ES Matrix 6.1 mode. Check the surround effects of the various modes before selecting the surround mode.

Speaker setting examples

Here we describe a number of speaker settings for different purposes. Use these examples as guides to set up your system according to the type of speakers used and the main usage purpose.

1. DTS-ES compatible system (using surround back speakers)

(1) Basic setting for primarily watching movies

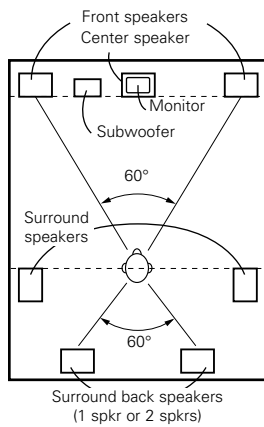

As seen from above

- Set the front speakers with their front surfaces as flush with the TV or monitor screen as possible. Set the center speaker between the front left and right speakers and no further from the listening position than the front speakers.
- Consult the owner's manual for your subwoofer for advice on placing the subwoofer within the listening room.
- If the surround speakers are direct-radiating (monopolar) then place them slightly behind and at an angle to the listening position and parallel to the walls at a position 60 to 90 centimeters (2 to 3 feet) above ear level at the prime listening position.
- When using two surround back speakers, place them at the back facing the front at a narrower distance than the front left and right speakers. When using one surround back speaker, place it at the rear center facing the front at a slightly higher position (0 to 20 cm) than the surround speakers.
- We recommend installing the surround back speaker(s) at a slightly downward facing angle. This effectively prevents the surround back channel signals from reflecting off the monitor or screen at the front center, resulting in interference and making the sense of movement from the front to the back less sharp.

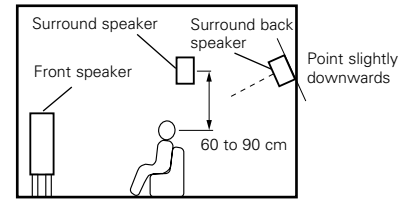

As seen from the side

(2) Setting for primarily watching movies using diffusion type speakers for the surround speakers

For the greatest sense of surround sound envelopment, diffuse radiation speakers such as bipolar types, or dipolar types, provide a wider dispersion than is possible to obtain from a direct radiating speaker (monopolar). Place these speakers at either side of the prime listening position, mounted above ear level.

Path of the surround sound from the speakers to the listening position

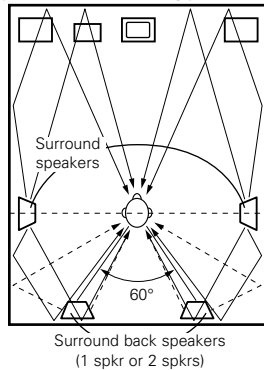

As seen from above

- Set the front speakers, center speaker and subwoofer in the same positions as in example (1).
- It is best to place the surround speakers directly at the side or slightly to the front of the viewing position, and 60 to 90 cm above the ears.
- Same as surround back speaker installation method (1). Using dipolar speakers for the surround back speakers as well is more effective.
- Connect the surround speakers to the surround speaker jacks.
- The signals from the surround channels reflect off the walls as shown on the diagram at the left, creating an enveloping and realistic surround sound presentation.

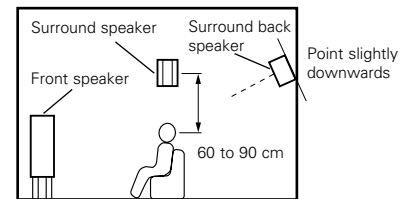

As seen from the side

For multi-channel music sources however, the use of bipolar or dipolar speakers mounted at the sides of the listening position may not be satisfactory in order to create a coherent 360 degree surround sound field. Connect another pair of direct radiating speakers as described in example (3) and place them at the rear corners of the room facing towards the prime listening position.

2. When not using surround back speakers

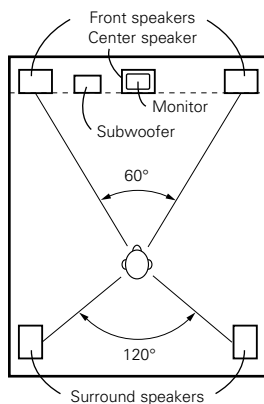

As seen from above

- Set the front speakers with their front surfaces as flush with the TV or monitor screen as possible. Set the center speaker between the front left and right speakers and no further from the listening position than the front speakers.
- Consult the owner's manual for your subwoofer for advice on placing the subwoofer within the listening room.
- If the surround speakers are direct-radiating (monopolar) then place them slightly behind and at an angle to the listening position and parallel to the walls at a position 60 to 90 centimeters (2 to 3 feet) above ear level at the prime listening position.

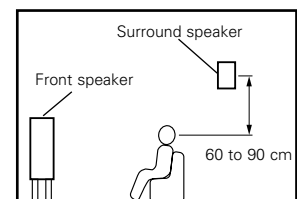

As seen from the side

Surround

The AVR-2803/983 is equipped with a digital signal processing circuit that lets you play program sources in the surround mode to achieve the same sense of presence as in a movie theater.

Dolby Surround

(1) Dolby Digital

Dolby Digital is the multi-channel digital signal format developed by Dolby Laboratories.

Dolby Digital consists of up to "5.1" channels - front left, front right, center, surround left, surround right, and an additional channel exclusively reserved for additional deep bass sound effects (the Low Frequency Effects – LFE – channel, also called the ".1" channel, containing bass frequencies of up to 120 Hz).

Unlike the analog Dolby Pro Logic format, Dolby Digital's main channels can all contain full range sound information, from the lowest bass, up to the highest frequencies – 22 kHz. The signals within each channel are distinct from the others, allowing pinpoint sound imaging, and Dolby Digital offers tremendous dynamic range from the most powerful sound effects to the quietest, softest sounds, free from noise and distortion.

■ Dolby Digital and Dolby Pro Logic

Comparison of home surround systems	Dolby Digital	Dolby Pro Logic
No. recorded channels (elements)	5.1 ch	2 ch
No. playback channels	5.1 ch	4 ch
Playback channels (max.)	L, R, C, SL, SR, SW	L, R, C, S (SW - recommended)
Audio processing	Digital discrete processing Dolby Digital encoding/decoding	Analog matrix processing Dolby Surround
High frequency playback limit of surround channel	20 kHz	7 kHz

■ Dolby Digital compatible media and playback methods

Marks indicating Dolby Digital compatibility:  .

The following are general examples. Also refer to the player's operating instructions.

Media	Dolby Digital output jacks	Playback method (reference page)
LD (VDP)	Coaxial Dolby Digital RF output jack ※1	Set the input mode to "AUTO". (Page 42)
DVD	Optical or coaxial digital output (same as for PCM) ※2	Set the input mode to "AUTO". (Page 42)
Others (satellite broadcasts, CATV, etc.)	Optical or coaxial digital output (same as for PCM)	Set the input mode to "AUTO". (Page 42)

※1 Please use a commercially available adapter when connecting the Dolby Digital RF output jack of the LD player to the digital input jack.

Please refer to the instruction manual of the adapter when making connection.

※2 Some DVD digital outputs have the function of switching the Dolby Digital signal output method between "bit stream" and "(convert to) PCM". When playing in Dolby Digital surround on the AVR-2803/983, switch the DVD player's output mode to "bit stream". In some cases players are equipped with both "bit stream + PCM" and "PCM only" digital outputs. In this case connect the "bit stream + PCM" jacks to the AVR-2803/983.

(2) Dolby Pro Logic II

- Dolby Pro Logic II is a new multi-channel playback format developed by Dolby Laboratories using feedback logic steering technology and offering improvements over conventional Dolby Pro Logic circuits.
- Dolby Pro Logic II can be used to decode not only sources recorded in Dolby Surround (※) but also regular stereo sources into five channels (front left, front right, center, surround left and surround right) to achieve surround sound.
- Whereas with conventional Dolby Pro Logic the surround channel playback frequency band was limited, Dolby Pro Logic II offers a wider band range (20 Hz to 20 kHz or greater). In addition, the surround channels were monaural (the surround left and right channels were the same) with previous Dolby Pro Logic, but Dolby Pro Logic II they are played as stereo signals.
- Various parameters can be set according to the type of source and the contents, so it is possible to achieve optimum decoding (see page 50).

※ Sources recorded in Dolby Surround

These are sources in which three or more channels of surround have been recorded as two channels of signals using Dolby Surround encoding technology.

Dolby Surround is used for the sound tracks of movies recorded on DVDs, LDs and Video cassettes to be played on stereo VCRs, as well as for the stereo broadcast signals of FM radio, TV, satellite broadcasts and cable TV.

Decoding these signals with Dolby Pro Logic II makes it possible to achieve multi-channel surround playback. The signals can also be played on ordinary stereo equipment, in which case they provide normal stereo sound.

There are two types of DVD Dolby surround recording signals.

- ① 2-channel PCM stereo signals
- ② 2-channel Dolby Digital signals

When either of these signals is input to the AVR-2803/983, the surround mode is automatically set to Dolby Pro Logic II when the "DOLBY/DTS SURROUND" mode is selected.

■ **Sources recorded in Dolby Surround are indicated with the logo mark shown below.**

Dolby Surround support mark: 

Manufactured under license from Dolby Laboratories.
 "Dolby", "Pro Logic" and the double-D symbol are trademarks of Dolby Laboratories.

DTS Digital Surround



Digital Theater Surround (also called simply DTS) is a multi-channel digital signal format developed by Digital Theater Systems. DTS offers the same "5.1" playback channels as Dolby Digital (front left, front right and center, surround left and surround right) as well as the stereo 2-channel mode. The signals for the different channels are fully independent, eliminating the risk of deterioration of sound quality due to interference between signals, crosstalk, etc.

DTS features a relatively higher bit rate as compared to Dolby Digital (1234 kbps for CDs and LDs, 1536 kbps for DVDs) so it operates with a relatively low compression rate. Because of this the amount of data is great, and when DTS playback is used in movie theaters, a separate CD-ROM synchronized with the film is played.

With LDs and DVDs, there is of course no need for an extra disc; the pictures and sound can be recorded simultaneously on the same disc, so the discs can be handled in the same way as discs with other formats.

There are also music CDs recorded in DTS. These CDs include 5.1-channel surround signals (compared to two channels on current CDs). They do not include picture data, but they offer surround playback on CD players that are equipped with digital outputs (PCM type digital output required). DTS surround track playback offers the same intricate, grand sound as in a movie theater, right in your own listening room.

■ **DTS compatible media and playback methods**

Marks indicating DTS compatibility:  and .

The following are general examples. Also refer to the player's operating instructions.

Media	Dolby Digital output jacks	Playback method (reference page)
CD	Optical or coaxial digital output (same as for PCM) ※2	Set the input mode to "AUTO" or "DTS" (page 42). Never set the mode to "ANALOG" or "PCM". ※1
LD (VDP)	Optical or coaxial digital output (same as for PCM) ※2	Set the input mode to "AUTO" or "DTS" (page 42). Never set the mode to "ANALOG" or "PCM". ※1
DVD	Optical or coaxial digital output (same as for PCM) ※3	Set the input mode to "AUTO" or "DTS" (page 42).

- ※1 DTS signals are recorded in the same way on CDs and LDs as PCM signals. Because of this, the un-decoded DTS signals are output as random "hissy" noise from the CD or LD player's analog outputs. If this noise is played with the amplifier set at a very high volume, it may possibly cause damage to the speakers. To avoid this, be sure to switch the input mode to "AUTO" or "DTS" before playing CDs or LDs recorded in DTS. Also, never switch the input mode to "ANALOG" or "PCM" during playback. The same holds true when playing CDs or LDs on a DVD player or LD/DVD compatible player. For DVDs, the DTS signals are recorded in a special way so this problem does not occur.
- ※2 The signals provided at the digital outputs of a CD or LD player may undergo some sort of internal signal processing (output level adjustment, sampling frequency conversion, etc.). In this case the DTS-encoded signals may be processed erroneously, in which case they cannot be decoded by the AVR-2803/983, or may only produce noise. Before playing DTS signals for the first time, turn down the master volume to a low level, start playing the DTS disc, then check whether the DTS indicator on the AVR-2803/983 (see page 53) lights before turning up the master volume.
- ※3 A DVD player with DTS-compatible digital output is required to play DTS DVDs. A DTS Digital Output logo is featured on the front panel of compatible DVD players. Recent DENON DVD player models feature DTS-compatible digital output – consult the player's owner's manual for information on configuring the digital output for DTS playback of DTS-encoded DVDs.

Manufactured under license from Digital Theater Systems, Inc. US Pat. No. 5,451,942, 5,956,674, 5,974,380, 5,978,762 and other world-wide patents issued and pending.
 "DTS", "DTS-ES Extended Surround" and "Neo:6" are trademarks of Digital Theater Systems, Inc. ©1996, 2000 Digital Theater Systems, Inc. All Rights Reserved.



DTS-ES Extended Surround™

DTS-ES Extended Surround is a new multi-channel digital signal format developed by Digital Theater Systems Inc. While offering high compatibility with the conventional DTS Digital Surround format, DTS-ES Extended Surround greatly improves the 360-degree surround impression and space expression thanks to further expanded surround signals. This format has been used professionally in movie theaters since 1999.

In addition to the 5.1 surround channels (FL, FR, C, SL, SR and LFE), DTS-ES Extended Surround also offers the SB (Surround Back, sometimes also referred to as "surround center") channel for surround playback with a total of 6.1 channels. DTS-ES Extended Surround includes two signal formats with different surround signal recording methods, as described below.

■ DTS-ES™ Discrete 6.1

DTS-ES Discrete 6.1 is the newest recording format. With it, all 6.1 channels (including the SB channel) are recorded independently using a digital discrete system. The main feature of this format is that because the SL, SR and SB channels are fully independent, the sound can be designed with total freedom and it is possible to achieve a sense that the acoustic images are moving about freely among the background sounds surrounding the listener from 360 degrees.

Though maximum performance is achieved when sound tracks recorded with this system are played using a DTS-ES decoder, when played with a conventional DTS decoder the SB channel signals are automatically down-mixed to the SL and SR channels, so none of the signal components are lost.

■ DTS-ES™ Matrix 6.1

With this format, the additional SB channel signals undergo matrix encoding and are input to the SL and SR channels beforehand. Upon playback they are decoded to the SL, SR and SB channels. The performance of the encoder used at the time of recording can be fully matched using a high precision digital matrix decoder developed by DTS, thereby achieving surround sound more faithful to the producer's sound design aims than with conventional 5.1- or 6.1-channel systems.

In addition, the bit stream format is 100% compatible with conventional DTS signals, so the effect of the Matrix 6.1 format can be achieved even with 5.1-channel signal sources. Of course it is also possible to play DTS-ES Matrix 6.1 encoded sources with a DTS 5.1-channel decoder.

When DTS-ES Discrete 6.1 or Matrix 6.1 encoded sources are decoded with a DTS-ES decoder, the format is automatically detected upon decoding and the optimum playing mode is selected. However, some Matrix 6.1 sources may be detected as having a 5.1-channel format, so the DTS-ES Matrix 6.1 mode must be set manually to play these sources.

(For instructions on selecting the surround mode, see page 53.)

The DTS-ES decoder includes another function, the DTS Neo:6 surround mode for 6.1-channel playback of digital PCM and analog signal sources.

■ DTS Neo:6™ surround

This mode applies conventional 2-channel signals to the high precision digital matrix decoder used for DTS-ES Matrix 6.1 to achieve 6.1-channel surround playback. High precision input signal detection and matrix processing enable full band reproduction (frequency response of 20 Hz to 20 kHz or greater) for all 6.1 channels, and separation between the different channels is improved to the same level as that of a digital discrete system.

DTS Neo:6 surround includes two modes for selecting the optimum decoding for the signal source.

• DTS Neo:6 Cinema

This mode is optimum for playing movies. Decoding is performed with emphasis on separation performance to achieve the same atmosphere with 2-channel sources as with 6.1-channel sources.

This mode is effective for playing sources recorded in conventional surround formats as well, because the in-phase component is assigned mainly to the center channel (C) and the reversed phase component to the surround (SL, SR and SB channels).

• DTS Neo:6 Music

This mode is suited mainly for playing music. Changes in the sound quality are reduced by decoding with emphasis on the front channel signals (FL and FR), and a natural sense of expansion is given to the sound field by the effect of the surround signals output from the center (C) and surround (SL, SR and SB) channels.

DTS 96/24

The sampling frequency, number of bits and number of channels used for recording of music, etc., in studios has been increasing in recent years, and there are a growing number of high quality signal sources, including 96 kHz/24 bit 5.1-channel sources.

For example, there are high picture/sound quality DVD video sources with 96 kHz/24 bit stereo PCM audio tracks.

However, because the data rate for these audio tracks is extremely high, there are limits to recording them on two channels only, and since the quality of the pictures must be restricted it is common to only include still pictures.

In addition, 96 kHz/24 bit 5.1-channel surround is possible with DVD audio sources, but DVD audio players are required to play them with this high quality.

DTS 96/24 is a multi-channel digital signal format developed by Digital Theater Systems Inc. in order to deal with this situation.

Conventional surround formats used sampling frequencies of 48 or 44.1 kHz, so 20 kHz was about the maximum playback signal frequency. With DTS 96/24, the sampling frequency is increased to 96 or 88.2 kHz to achieve a wide frequency range of over 40 kHz.

In addition, DTS 96/24 has a resolution of 24 bits, resulting in the same frequency band and dynamic range as 96 kHz/24 bit PCM.

As with conventional DTS Surround, DTS 96/24 is compatible with a maximum of 5.1 channels, so sources recorded using DTS 96/24 can be played in high sampling frequency, multiple channel audio with such normal media as DVD videos and CDs.

Thus, with DTS 96/24, the same 96 kHz/24 bit multi-channel surround sound as with DVD-Audio can be achieved while viewing DVD-Video images on a conventional DVD-Video player (*1). Furthermore, with DTS 96/24 compatible CDs, 88.2 kHz/24 bit multi-channel surround can be achieved using normal CD/LD players (*1).

Even with the high quality multi-channel signals, the recording time is the same as with conventional DTS surround sources.

What's more, DTS 96/24 is fully compatible with the conventional DTS surround format, so DTS 96/24 signal sources can be played with a sampling frequency of 48 kHz or 44.1 kHz on conventional DTS or DTS-ES surround decoders (*2).

*1: A DVD player with DTS digital output capabilities (for CD/LD players, a player with digital outputs for conventional DTS CDs/LDs) and a disc recorded in DTS 96/24 are required.

*2: The resolution is 24 or 20 bits, depending on the decoder.

System setup items and default values (set upon shipment from the factory)

System setup				Default settings										
①	Speaker Configuration	Input the combination of speakers in your system and their corresponding sizes (Small for regular speakers, Large for full-size, full-range) to automatically set the composition of the signals output from the speakers and the frequency response.		Front Sp.	Center Sp.	Sub Woofer	Surround Sp.	Surround Back Sp.						
				Large	Small	Yes	Small	Small / 2spkrs						
	Crossover Frequency	Set the frequency (Hz) below which the bass sound of the various speakers is to be output from the subwoofer.		80 Hz										
	Subwoofer mode	This selects the subwoofer speaker for playing deep bass signals.		LFE										
②	Delay Time	This parameter is for optimizing the timing with which the audio signals are produced from the speakers and subwoofer according to the listening position.		Front L & R		Center	Sub Woofer	Surround L & R		SBL & SBR				
				12 ft (3.6 m)		12 ft (3.6 m)	12 ft (3.6 m)	10 ft (3.0 m)		10 ft (3.0 m)				
③	Channel Level	This adjusts the volume of the signals output from the speakers and subwoofer for the different channels in order to obtain optimum effects.		Front L	Front R	Center	Surround L	Surround R	Surround Back L	Surround Back R	Subwoofer			
				0 dB	0 dB	0 dB	0 dB	0 dB	0 dB	0 dB	0 dB			
④	Digital In Assignment	This assigns the digital input jacks for the different input sources.		Input source	CD	DVD	VDP	TV	DBS	V. AUX	VCR-1	VCR-2	TAPE	
				Digital Inputs	COAX1	COAX2	OPT1	OPT2	OPT3	OFF	OFF	OFF	OPT4	
⑤	Video In Assign	This assigns the color difference (component) video input jacks for the different input sources.		DVD	VDP	TV	DBS	VCR-1	VCR-2	V. AUX	—	—		
				VIDEO1	NONE	NONE	VIDEO2	NONE	NONE	NONE	—	—		
⑥	Dolby Digital Setup	Turn the audio compression on or off when down-mixing Dolby Digital signals.		OFF										
⑦	Zone 2 Control	Power AMP Assignment	Set this to switch the surround back channel's power amplifier for use for zone 2.		Surround Back									
		Zone2 vol. Level	This sets the output level for the zone 2 output jacks.		Variable									
⑧	Ext. In Subwoofer Level	Set the Ext. In Subwoofer terminal playback level.		Subwoofer = +15 dB										
⑨	Auto Surround Mode	Set the Auto surround mode function.		Auto Surround Mode = ON										
⑩	On Screen Display	This sets whether or not to display the on-screen display that appears on the monitor screen when the controls on the remote control unit or main unit are operated.		On Screen Display = ON										
⑪	Trigger Out Setup	Set the Trigger Out output for the different input sources.		PHONO	CD	TUNER	TAPE	DVD	VDP	TV	DBS	VCR-1	VCR-2	V. AUX
				OFF	OFF	OFF	OFF	ON	ON	ON	ON	ON	ON	ON
⑫	Auto Tuner Presets	FM stations are received automatically and stored in the memory.		A1 ~ A8	87.5/89.1/98.1/107.9/90.1/90.1/90.1 MHz									
				B1 ~ B8	520/600/1000/1400/1500/1710 kHz, 90.1/90.1 MHz									
				C1 ~ C8	90.1 MHz									
				D1 ~ D8	90.1 MHz									
				E1 ~ E8	90.1 MHz									
⑬	Setup Lock	Set whether or not to lock the system setup settings so that they cannot be changed.		Setup Lock = OFF										

Surround modes and parameters

Mode	Signals and adjustability in the different modes								
	Channel output					When playing Dolby Digital signals	When playing DTS signals	When playing PCM signals	When playing ANALOG signals
	FRONT L/R	CENTER	SURROUND L/R	SUB-WOOFER	SURROUND BACK L/R				
DIRECT	○	×	×	⊗	×	○	○	○	○
STEREO	○	×	×	⊗	×	○	○	○	○
EXTERNAL INPUT	○	⊗	⊗	⊗	⊗	×	×	×	○
DOLBY PRO LOGIC II	○	⊗	⊗	⊗	⊗ *2	○ *1	×	○	○
DTS NEO:6	○	⊗	⊗	⊗	⊗	○ *1	×	○	○
DOLBY DIGITAL	○	⊗	⊗	⊗	⊗	○	×	×	×
DTS SURROUND (DTS ES MTRX 6.1)	○	⊗	⊗	⊗	⊗	×	○	×	×
5/7CH STEREO	○	⊗	⊗	⊗	⊗	○	○	○	○
ROCK ARENA	○	⊗	⊗	⊗	⊗	○	○	○	○
JAZZ CLUB	○	⊗	⊗	⊗	⊗	○	○	○	○
VIDEO GAME	○	⊗	⊗	⊗	⊗	○	○	○	○
MONO MOVIE	○	⊗	⊗	⊗	⊗	○	○	○	○
MATRIX	○	⊗	⊗	⊗	⊗	○	○	○	○
VIRTUAL	○	×	×	⊗	×	○	○	○	○

○ : Signal
 × : No signal
 ⊗ : Turned on or off by speaker configuration setting

○ : Able
 × : Unable

*1 Only for 2 ch contents.
 *2 Signal output can be changed with the "SB CH OUT" surround parameter setting.

Mode	Signals and adjustability in the different modes												
	Parameter (default values are shown in parentheses)												When playing Dolby Digital/DTS signals
	SURROUND PARAMETER							PRO LOGIC II MUSIC MODE ONLY			NEO:6 MUSIC MODE ONLY		
	TO NE CONTROL	MODE	CINEMA EQ.	ROOM SIZE	EFFECT LEVEL	DELAY TIME	SURROUND BACK	PANORAMA	DIMENSION	CENTER WIDTH	CENTER IMAGE	D. COMP	
DIRECT	×	×	×	×	×	×	×	×	×	×	×	○ (OFF)	○ (0dB)
STEREO	○ (0dB)	×	×	×	×	×	×	×	×	×	×	○ (OFF)	○ (0dB)
EXTERNAL INPUT	×	×	×	×	×	×	×	×	×	×	×	×	×
DOLBY PRO LOGIC II	○ (0dB)	○ (CINEMA)	○ (OFF) (Note2)	×	×	×	○ (NRML (OFF))	○ (OFF)	○ (3)	○ (3)	×	○ (OFF)	○ (0dB)
DTS NEO:6	○ (0dB)	○ (CINEMA)	○ (OFF) (Note3)	×	×	×	○ (NRML (ON))	×	×	×	○ (0.2)	○ (OFF)	○ (0dB)
DOLBY DIGITAL	○ (0dB)	×	○ (OFF)	×	×	×	○ (MTRX ON)	×	×	×	×	○ (OFF)	○ (0dB)
DTS SURROUND (DTS ES MTRX 6.1)	○ (0dB)	×	○ (OFF)	×	×	×	○ (MTRX ON)	×	×	×	×	○ (OFF)	○ (0dB)
5/7CH STEREO	○ (0dB)	×	×	×	×	×	○	×	×	×	×	○ (OFF)	○ (0dB)
ROCK ARENA	○ (Note1)	×	×	○ (Medium)	○ (10)	×	○	×	×	×	×	○ (OFF)	○ (0dB)
JAZZ CLUB	○ (0dB)	×	×	○ (Medium)	○ (10)	×	○	×	×	×	×	○ (OFF)	○ (0dB)
VIDEO GAME	○ (0dB)	×	×	○ (Medium)	○ (10)	×	○	×	×	×	×	○ (OFF)	○ (0dB)
MONO MOVIE	○ (0dB)	×	×	○ (Medium)	○ (10)	×	○	×	×	×	×	○ (OFF)	○ (0dB)
MATRIX	○ (0dB)	×	×	×	×	○ (30msec)	○	×	×	×	×	○ (OFF)	○ (0dB)
VIRTUAL	○ (0dB)	×	×	×	×	×	×	×	×	×	×	○ (OFF)	○ (0dB)

(Note 1) BASS: +8 dB, TREBLE: 4 dB
 (Note 2) Cinema, DOLBY PL Mode only
 (Note 3) Cinema Mode only

○ : Adjustable
 × : Not adjustable

■ Differences in surround mode names depending on the input signals

Surround Mode	Input signals						
	ANALOG	LINEAR PCM	DTS			DOLBY DIGITAL	
			DTS (5.1 ch)	DTS 96/24 (5.1 ch)	DTS (6.1 ch)	D. D. (2 ch)	D. D. (5.1 ch)
DIRECT	○	○	○	○	○	○	○
STEREO	○	○	○	○	○	○	○
DTS SURROUND	DTS NEO:6	DTS NEO:6	*DTS ES MTRX DTS SURROUND	*DTS ES MTRX DTS 96/24	◎ ES DSCRT6.1 ES MTRX6.1 *DTS SURROUND	DTS NEO:6	×
DOLBY SURROUND	DOLBY PRO LOGIC II	DOLBY PRO LOGIC II	×	×	×	DOLBY PRO LOGIC II	*DOLBY DIGITAL EX DOLBY DIGITAL
DSP SIMULATION	○	○	○	○	○	○	○

○ : Selectable

* : The surround mode name differs depending on the "SB CH OUT" surround parameter setting.

◎ : The surround mode name differs depending on the input signal.

× : Not selectable

17 SPECIFICATIONS

■ Audio section

• Power amplifier

Rated output:

Front:	90 W + 90 W	(8 Ω/ohms, 20 Hz ~ 20 kHz with 0.05% T.H.D.)
	125 W + 125 W	(6 Ω/ohms, 1 kHz with 0.7% T.H.D.)
Center:	90 W	(8 Ω/ohms, 20 Hz ~ 20 kHz with 0.05% T.H.D.)
	125 W	(6 Ω/ohms, 1 kHz with 0.7% T.H.D.)
Surround:	90 W + 90 W	(8 Ω/ohms, 20 Hz ~ 20 kHz with 0.05% T.H.D.)
	125 W + 125 W	(6 Ω/ohms, 1 kHz with 0.7% T.H.D.)
Surround Back:	90 W + 90 W	(8 Ω/ohms, 20 Hz ~ 20 kHz with 0.05% T.H.D.)
	125 W + 125 W	(6 Ω/ohms, 1 kHz with 0.7% T.H.D.)

Dynamic power:

120 W x 2 ch	(8 Ω/ohms)
170 W x 2 ch	(4 Ω/ohms)
200 W x 2 ch	(2 Ω/ohms)

Output terminals:

Front:	A or B	6 ~ 16 Ω/ohms
	A + B	8 ~ 16 Ω/ohms
Center, Surround, Surr. Back/Zone 2:		6 ~ 16 Ω/ohms

• Analog

Input sensitivity / input impedance:

200 mV / 47 kΩ/kohms

Frequency response:

10 Hz ~ 100 kHz: +0, -3 dB (DIRECT mode)

S/N:

102 dB (DIRECT mode)

Distortion:

0.005% (20 Hz ~ 20 kHz) (DIRECT mode)

Rated output:

1.2 V

• Digital

D/A output:

Rated output — 2 V (at 0 dB playback)

Total harmonic distortion — 0.008% (1 kHz, at 0 dB)

S/N ratio — 102 dB

Dynamic range — 96 dB

Format — Digital audio interface

Digital input:

• Phono equalizer (PHONO input — REC OUT)

Input sensitivity:

2.5 mV

RIAA deviation:

±1 dB (20 Hz to 20 kHz)

Signal-to-noise ratio:

74 dB (A weighting, with 5 mV input)

Rated output / Maximum output:

150 mV / 8 V

Distortion factor:

0.03% (1 kHz, 3 V)

■ Video section

• Standard video jacks

Input / output level and impedance:

1 Vp-p, 75 Ω/ohms

Frequency response:

5 Hz ~ 10 MHz — +0, -3 dB

• S-video jacks

Input / output level and impedance:

Y signal — 1 Vp-p, 75 Ω/ohms

C signal — 0.286 Vp-p, 75 Ω/ohms

Frequency response:

5 Hz ~ 10 MHz — +0, -3 dB

• Color component video jacks

Input / output level and impedance:

Y signal — 1 Vp-p, 75 Ω/ohms

P_B/C_B signal — 0.7 Vp-p, 75 Ω/ohms

P_R/C_R signal — 0.7Vp-p, 75 Ω/ohms

DC ~ 100 MHz — +0, -3 dB

Frequency response:

■ Tuner section

Receiving Range:

[FM] (note: μV at 75 Ω/ohms, 0 dBf=1 x 10⁻¹⁵ W)

87.50 MHz ~ 107.90 MHz

[AM]

520 kHz ~ 1710 kHz

Usable Sensitivity:

1.0 μV (11.2 dBf)

18 μV

50 dB Quieting Sensitivity:

MONO 1.6 μV (15.3 dBf)

STEREO 23 μV (38.5 dBf)

S/N (IHF-A):

MONO 77 dB

STEREO 72 dB

Total Harmonic Distortion (at 1 kHz):

MONO 0.15%

STEREO 0.3%

■ General

Power supply:

AC 120 V, 60 Hz

Power consumption:

5.5 A

1 W Max (Standby)

Maximum external dimensions:

434 (W) x 171 (H) x 416 (D) mm (17-3/32" x 6-47/64" x 16-3/8")

Mass:

13.0 kg (28 lbs 11 oz)

■ Remote control unit (RC-924)

Batteries:

R6P/AA Type (three batteries)

External dimensions:

58 (W) x 230 (H) x 37 (D) mm (2-9/32" x 9-1/16" x 1-29/64")

Mass:

230 g (Approx. 8 oz) (including batteries)

* For purposes of improvement, specifications and design are subject to change without notice.

DENON, Ltd.

16-11, YUSHIMA 3-CHOME, BUNKYOU-KU, TOKYO 113-0034, JAPAN
Telephone: (03) 3837-5321

Printed in Japan 511 4012 002

