

USER MANUAL



IMPORTANT INFORMATION THAT MAY IMPACT YOUR MANUFACTURER'S WARRANTY

Adherence to the directions for use in this manual is extremely important for health and safety. Failure to strictly adhere to the requirements in this manual may result in personal injury, property damage and affect your ability to make a claim under the AEG manufacturer's warranty provided with your product. Products must be used, installed and operated in accordance with this manual. You may not be able to claim on the AEG manufacturer's warranty in the event that your product fault is due to failure to adhere to this manual.

FOR PERFECT RESULTS

Thank you for choosing this AEG product. We have created it to give you impeccable performance for many years, with innovative technologies that help make life simpler features you might not find on ordinary appliances. Please spend a few minutes reading to get the very best from it.

Visit our website for:



Get usage advice, brochures, trouble shooter, service information:
www.aeg.com



Register your product for better service:
www.registeraeg.com

CUSTOMER CARE AND SERVICE

Always use original spare parts.

When contacting our Authorised Service Centre, ensure that you have the following data available: Model, PNC, Serial Number.

The information can be found on the rating plate.

 Warning / Caution-Safety information

 General information and tips

 Environmental information

CONTENTS

1. SAFETY INFORMATION.....	3	3.7 Service.....	9
1.1 Children and vulnerable people safety.....	3	3.8 Disposal.....	9
1.2 General Safety.....	4	4. PRODUCT DESCRIPTION.....	9
2. CONDITIONS OF USE.....	5	4.1 General overview.....	9
3. SAFETY INSTRUCTIONS.....	5	4.2 Accessories.....	9
3.1 Installation.....	5	5. HOW TO TURN OVEN ON AND OFF.....	10
3.2 Electrical connection.....	6	5.1 Control panel.....	10
3.3 Use.....	7	5.2 Display.....	11
3.4 Care and cleaning.....	7	6. BEFORE FIRST USE.....	13
3.5 Pyrolytic cleaning.....	8	6.1 Initial Cleaning	13
3.6 Internal lighting.....	8	6.2 First connection.....	13

6.3 Wireless connection	13	12. CARE AND CLEANING.....	29
6.4 Software licences.....	14	12.1 Notes on cleaning.....	30
6.5 Initial preheating.....	15	12.2 How to remove: Shelf supports ...	30
7. DAILY USE.....	15	12.3 How to use: Pyrolytic Cleaning....	31
7.1 How to set: Heating functions.....	15	12.4 Cleaning Reminder.....	31
7.2 How to set: Assisted Cooking.....	16	12.5 How to remove and install: Door..	32
7.3 Heating functions.....	16	12.6 How to replace: Lamp.....	33
7.4 Notes on: Moist Fan Baking.....	18	13. TROUBLESHOOTING.....	34
8. CLOCK FUNCTIONS.....	18	13.1 What to do if.....	34
8.1 Clock functions description.....	18	13.2 How to manage: Error codes.....	35
8.2 How to set: Clock functions.....	19	13.3 Service data.....	36
9. HOW TO USE: ACCESSORIES.....	21	14. ENERGY EFFICIENCY.....	37
9.1 Inserting accessories.....	21	14.1 Product Information and Product	
9.2 Using Trivet and Grill- /		Information Sheet*.....	37
Roasting pan.....	22	14.2 Energy saving.....	37
9.3 Food Sensor.....	23	15. MENU STRUCTURE.....	38
10. ADDITIONAL FUNCTIONS.....	25	15.1 Menu.....	38
10.1 How to save: Favourites.....	25	15.2 Submenu for: Cleaning.....	39
10.2 Function lock.....	25	15.3 Submenu for: Options.....	39
10.3 Automatic switch-off.....	25	15.4 Submenu for: Connections.....	39
10.4 Cooling fan.....	26	15.5 Submenu for: Setup.....	40
11. HINTS AND TIPS.....	26	15.6 Submenu for: Service.....	40
11.1 Cooking recommendations.....	26	16. IT'S EASY!.....	41
11.2 Moist Fan Baking.....	26	17. TAKE A SHORTCUT!.....	42
11.3 Moist Fan Baking -		18. WARRANTY	43
recommended accessories.....	27	19. ENVIRONMENTAL CONCERNS.....	45
11.4 Cooking tables for test institutes..	27		

Subject to change without notice.

1. ⚠ SAFETY INFORMATION

Before the installation and use of the appliance, carefully read the supplied instructions. The manufacturer is not responsible for any injuries or damage that are the result of incorrect installation or usage. Always keep the instructions in a safe and accessible location for future reference.

1.1 Children and vulnerable people safety

- This appliance can be used by children aged from 8 years and above and persons with reduced physical, sensory or

mental capabilities or lack of experience and knowledge if they have been given supervision or instruction concerning the use of the appliance in a safe way and understand the hazards involved. Children of less than 8 years of age and persons with very extensive and complex disabilities shall be kept away from the appliance unless continuously supervised.

- Children should be supervised to ensure that they do not play with the appliance and mobile devices with AEG Home .
- Keep all packaging away from children and dispose of it appropriately.
- **WARNING:** Keep children and pets away from the appliance when it operates or when it cools down. Accessible parts become hot during use.
- If the appliance has a child safety device, it should be activated.
- Children shall not carry out cleaning and user maintenance of the appliance without supervision.

1.2 General Safety

- Only a qualified person must install this appliance and replace the cable.
- Do not use the appliance before installing it in the built-in structure.
- Disconnect the appliance from the power supply before carrying out any maintenance.
- If the mains power supply cable is damaged, it must be replaced by the manufacturer, its Authorised Service Centre or similarly qualified persons to avoid an electrical hazard.
- The means for disconnection must be incorporated in the fixed wiring in accordance with the wiring rules.
- **WARNING:** Ensure that the appliance is switched off before replacing the lamp to avoid the possibility of electric shock.

- **WARNING:** The appliance and its accessible parts become hot during use. Care should be taken to avoid touching heating elements.
- Always use oven gloves to remove or put in accessories or ovenware.
- Use only the food sensor (core temperature sensor) recommended for this appliance.
- Do not use a steam cleaner to clean the appliance.
- Do not use harsh abrasive cleaners or sharp metal scrapers to clean the glass door since they can scratch the surface, which may result in shattering of the glass.
- Excessive spillage must be removed before the pyrolytic cleaning. Remove all parts from the oven.

2. CONDITIONS OF USE

This appliance is intended to be used in household and similar applications such as:

- Farm houses
- By clients in serviced apartments, holiday apartments and other residential type environments.

3. SAFETY INSTRUCTIONS

3.1 Installation

**WARNING!**

Only a qualified person must install this appliance.

- Remove all the packaging.
- Do not install or use a damaged appliance.
- Follow the installation instructions supplied with the appliance.
- Always take care when moving the appliance as it is heavy. Always use safety gloves and enclosed footwear.
- Do not pull the appliance by the handle.
- Install the appliance in a safe and suitable place that meets installation requirements.
- Keep the minimum distance from other appliances and units.
- Before mounting the appliance, check if the oven door opens without restraint.
- The appliance is equipped with an electric cooling system. It must be operated with the electric power supply.
- The built-in unit must meet the stability requirements of DIN 68930.

Cabinet minimum height (Cabinet under the work-top minimum height)	578 (600) mm
--	--------------

SAFETY INSTRUCTIONS

Cabinet width	560 mm
Cabinet depth	550 (550) mm
Height of the front of the appliance	594 mm
Height of the back of the appliance	576 mm
Width of the front of the appliance	595 mm
Width of the back of the appliance	559 mm
Depth of the appliance	567 mm
Built in depth of the appliance	546 mm
Depth with open door	1027 mm
Ventilation opening minimum size. Opening placed on the bottom rear side	560 x 20 mm
Mounting screws	4 x 25 mm

3.2 Electrical connection



WARNING!

Risk of fire and electric shock.

- All electrical connections should be made by a qualified electrician.
- The appliance must be earthed.
- Make sure that the parameters on the rating plate are compatible with the electrical ratings of the mains power supply.
- Always use a correctly installed shockproof socket.
- Do not use multi-plug adapters and extension cables.
- Make sure not to cause damage to the mains plug and to the mains cable. Should the mains cable need to be replaced, this must be carried out by our Authorised Service Centre.
- Do not let mains cables touch or come near the appliance door or the niche below the appliance, especially when it operates or the door is hot.
- The shock protection of live and insulated parts must be fastened in such a way that it cannot be removed without tools.
- Connect the mains plug to the mains socket only at the end of the installation. Make sure that there is access to the mains plug after the installation.
- If the mains socket is loose, do not connect the mains plug.
- Do not pull the mains cable to disconnect the appliance. Always pull the mains plug.
- Use only correct isolation devices: line protecting cut-outs, fuses (screw type fuses removed from the holder), earth leakage trips and contactors.

- The electrical installation must have an isolation device which lets you disconnect the appliance from the mains at all poles. The isolation device must have a contact opening width of minimum 3 mm.
- Fully close the appliance door before you connect the mains plug to the mains socket.
- This appliance is supplied without a main plug and a main cable.

3.3 Use



WARNING!

Risk of injury, burns and electric shock or explosion.

- Do not change the specification of this appliance.
- Make sure that the ventilation openings are not blocked.
- Do not let the appliance stay unattended during operation.
- Deactivate the appliance after each use.
- Be careful when you open the appliance door while the appliance is in operation. Hot air can release.
- Do not operate the appliance with wet hands or when it has contact with water.
- Do not apply pressure on the open door.
- Do not use the appliance as a work surface or as a storage surface.
- Open the appliance door carefully. The use of ingredients with alcohol can cause a mixture of alcohol and air.
- Do not let sparks or open flames to come in contact with the appliance when you open the door.
- Do not put flammable products or items that are wet with flammable products in, near or on the appliance.
- Do not share your Wi-Fi password.



WARNING!

Risk of damage to the appliance.

- To prevent damage or discoloration to the enamel:
 - do not put overware or other objects in the appliance directly on the bottom.
 - do not put aluminium foil directly on the bottom of cavity of the appliance.
 - do not put water directly into the hot appliance.
 - do not keep moist dishes and food in the appliance after you finish the cooking.
 - be careful when you remove or install the accessories.
- Discoloration of the enamel or stainless steel has no effect on the performance of the appliance.
- This appliance is for cooking purposes only. It must not be used for other purposes, for example room heating.
- Always cook with the oven door closed.
- If the appliance is installed behind a furniture panel (e.g. a door) make sure the door is never closed when the appliance operates. Heat and moisture can build up behind a closed furniture panel and cause subsequent damage to the appliance, the housing unit or the floor. Do not close the furniture panel until the appliance has cooled down completely after use.

3.4 Care and cleaning



WARNING!

Risk of injury, fire, or damage to the appliance.

SAFETY INSTRUCTIONS

- Before maintenance, deactivate the appliance and disconnect the mains plug from the mains socket.
- Make sure the appliance is cold. There is the risk that the glass panels can break.
- Replace immediately the door glass panels when they are damaged. Contact the Authorised Service Centre.
- Be careful when you remove the door from the appliance. The door is heavy!
- Clean regularly the appliance to prevent the deterioration of the surface material.
- Clean the appliance with a moist soft cloth. Use only neutral detergents. Do not use abrasive products, abrasive cleaning pads, solvents or metal objects.
- If you use an oven spray, follow the safety instructions on its packaging.

3.5 Pyrolytic cleaning



WARNING!

Risk of Injury / Fires / Chemical Emissions (Fumes) in Pyrolytic Mode.

- Before carrying out a Pyrolytic self-cleaning function or the First Use please remove from the oven cavity:
 - any excess food residues, oil or grease spills / deposits.
 - any removable objects (including shelves provided with the product) particularly any non-stick pots, pans, trays, utensils etc.
- Read carefully all the instructions for Pyrolytic cleaning.
- Keep children away from the appliance while the Pyrolytic cleaning operates. The appliance becomes very hot and hot air is released from the front cooling vents.
- Pyrolytic cleaning is a high temperature operation that can release fumes from cooking residues and construction materials, as such consumers are strongly advised to:
 - provide good ventilation during and after each Pyrolytic cleaning.
 - provide good ventilation during and after the first use at maximum temperature operation.
- Unlike all humans, some birds and reptiles can be extremely sensitive to potential fumes emitted during the cleaning process of all Pyrolytic Ovens.
 - Remove any pets (especially birds) from the vicinity of the appliance location during and after the Pyrolytic cleaning and first use maximum temperature operation to a well ventilated area.
- Small pets can also be highly sensitive to the localized temperature changes in the vicinity of all Pyrolytic Ovens when the Pyrolytic self cleaning program is in operation.
- Non-stick surfaces on pots, pans, trays, utensils etc., can be damaged by the high temperature Pyrolytic cleaning operation of all Pyrolytic Ovens and can be also a source for low level harmful fumes.
- Fumes released from all Pyrolytic Ovens / Cooking Residues as described are not harmful to humans, including children, or persons with medical conditions.

3.6 Internal lighting



WARNING!

Risk of electric shock.

- Concerning the lamp(s) inside this product and spare part lamps sold separately: These lamps are intended to withstand extreme physical conditions in household appliances, such as temperature, vibration, humidity, or are intended to signal information about the operational status of the appliance. They are not intended to be used in other applications and are not suitable for household room illumination.

- Use only lamps with the same specifications.

3.7 Service

- To repair the appliance contact the Authorised Service Centre.
- Use original spare parts only.

3.8 Disposal



WARNING!

Risk of injury or suffocation.

- Contact your municipal authority for information on how to dispose of the appliance.
- Disconnect the appliance from the mains supply.
- Cut off the mains electrical cable close to the appliance and dispose of it.
- Remove the door catch to prevent children or pets from becoming trapped in the appliance.

4. PRODUCT DESCRIPTION

4.1 General overview

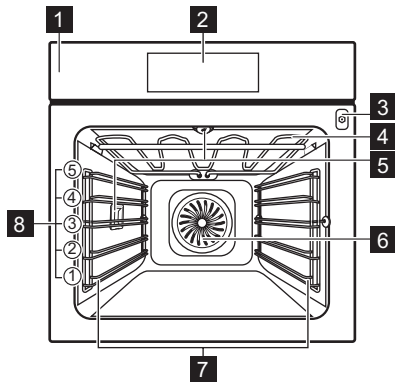

- 1 Control panel
- 2 Display
- 3 Socket for the food sensor
- 4 Heating element
- 5 Lamp
- 6 Fan
- 7 Shelf support, removable
- 8 Shelf positions

4.2 Accessories

Wire shelf

For cookware, cake tins, roasts.

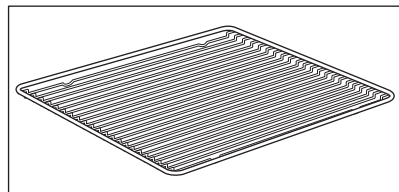

HOW TO TURN OVEN ON AND OFF

Baking tray

For cakes and biscuits.

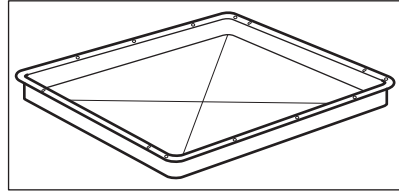

Grill- / Roasting pan

To bake and roast or as a pan to collect fat.

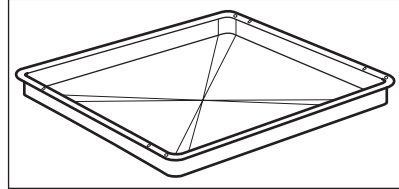

Trivet

For roasting and grilling.

Use the trivet only with the Grill- / Roasting pan.

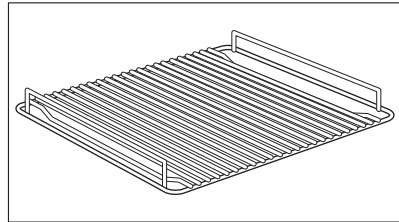

Food sensor

To measure the temperature inside food.

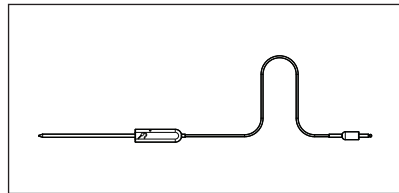

Telescopic runners

For inserting and removing trays and wireshelf more easily.

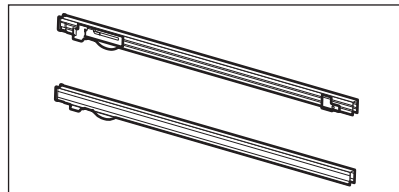



5. HOW TO TURN OVEN ON AND OFF

5.1 Control panel

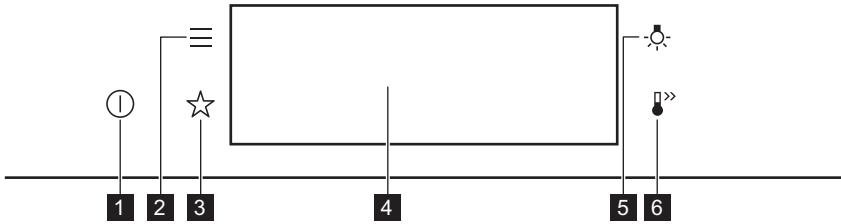
HOW TO TURN OVEN ON AND OFF



1	ON / OFF	Press and hold to turn the oven on and off.
2	Menu	Lists the oven functions.
3	Favourites	Lists the favourite settings.
4	Display	Shows the current settings of the oven.
5	Lamp switch	To turn the lamp on and off.
6	Fast Heat Up	To turn on and off the function: Fast Heat Up.







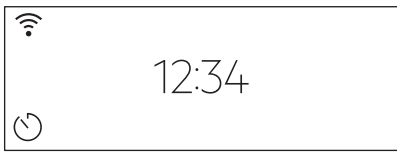
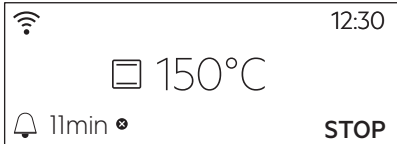
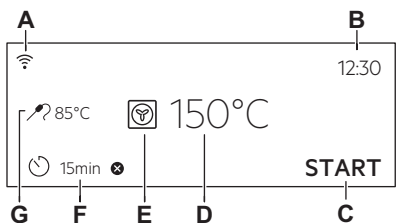

 Press	 Move	 Press and hold
Touch the surface with fingertip.	Slide fingertip over the surface.	Touch the surface for 3 seconds.

5.2 Display

	<p>After turning on, the display shows the main screen with the heating function and the default temperature.</p>
---	---

HOW TO TURN OVEN ON AND OFF

	<p>If you do not use the oven for 2 minutes, the display goes to standby.</p>
	<p>When you cook, the display shows the set functions and other available options.</p>
	<p>Display with key functions set.</p> <ul style="list-style-type: none"> A. Wi-Fi B. Time of day C. START/STOP D. Temperature E. Heating functions F. Timer G. Food sensor (selected models only)

<h2>Display indicators</h2>			
<p>Basic indicators - to navigate on the display.</p>			
<p style="text-align: center;"> To confirm the selection / setting.</p>	<p style="text-align: center;"> To go one level back in the menu.</p>	<p style="text-align: center;"> To undo the last action.</p>	<p style="text-align: center;"> To turn the options on and off.</p>
<p>Sound alarm function indicators - when the set time of cooking ends, the signal sounds.</p>			
<p style="text-align: center;"> The function is on.</p>	<p style="text-align: center;"> The function is on. Cooking stops automatically.</p>	<p style="text-align: center;"> Sound alarm is off.</p>	
<h2>Timer indicators</h2>			
<p style="text-align: center;"> To set the function: Delayed start.</p>	<p style="text-align: center;"> To cancel the setting.</p>		
<p>Wi-Fi indicator - the oven can be connected to Wi-Fi.</p>			



Wi-Fi connection is turned on.



6. BEFORE FIRST USE



WARNING!

Refer to Safety chapters.

6.1 Initial Cleaning

		
<p>Step 1</p>	<p>Step 2</p>	<p>Step 3</p>
<p>Remove all accessories except for the shelf supports and the telescopic runners.</p>	<p>Clean the oven and the accessories with a soft cloth, warm water and a mild detergent.</p>	<p>Place the accessories in the oven.</p>

6.2 First connection



The display shows welcome message after the first connection.

You have to set: Language, Display brightness, Key tones, Buzzer volume, Time of day.

6.3 Wireless connection

To connect the oven you need:

- Wireless network with the Internet connection.
- Mobile device connected to your wireless network.

<p>Step 1</p>	<p>Download the mobile app AEG Home and follow the instructions for the next steps.</p>
<p>Step 2</p>	<p>Turn on the oven.</p>
<p>Step 3</p>	<p>Press: . Select: Settings / Connections.</p>
<p>Step 4</p>	<p> - slide or press to turn on: Wi-Fi.</p>
<p>Step 5</p>	<p>The oven wireless module starts within 90 sec.</p>

BEFORE FIRST USE

Take a shortcut!



Frequency	2.4 GHz WLAN	5 GHz WLAN
	2400 - 2483.5 MHz	5150 - 5350 MHz 5470 - 5725 MHz
Protocol	IEEE 802.11b DSSS, 802.11g/n OFDM	IEEE 802.11 a/n OFDM
Max Power	EIRP < 20 dBm (100 mW)	EIRP < 23 dBm (200 mW)
Wi-Fi module	NIU5-50	

Frequency Bluetooth	2400 - 2483.5 MHz
Protocol	LE: DSSS
Max Power	EIRP < 4 dBm (2.5 mW)



6.4 Software licences

The software in this product contains components that are based on free and open source software. AEG gratefully acknowledges the contributions of the open software and robotics communities to the development project.

To access the source code of these free and open source software components whose license conditions require publishing, and to see their full copyright information and applicable license terms, please visit: <http://aeg.opensourcerepository.com> (folder NIU5).

6.5 Initial preheating



Preheat the empty oven before the first use.

Step 1	Remove all accessories and removable shelf supports from the oven.
Step 2	Set the maximum temperature for the function: . Let the oven operate for 1 h.
Step 3	Set the maximum temperature for the function: . Let the oven operate for 15 min.
<p> The oven can emit an odour and smoke during preheating. Make sure that the room is ventilated.</p>	

7. DAILY USE



WARNING!

Refer to Safety chapters.

7.1 How to set: Heating functions

Step 1	Turn on the oven. The display shows the default heating function.
Step 2	Press the symbol of the heating function to enter the submenu.
Step 3	Select the heating function and press: OK . The display shows: temperature.
Step 4	Set: temperature. Press: OK .
Step 5	Press: START . Food Sensor - you can plug the sensor at any time before or during cooking.
STOP - press to turn off the heating function.	
Step 6	Turn off the oven.

Take a shortcut!



7.2 How to set: Assisted Cooking



Every dish in this submenu has a recommended function and temperature. You can adjust the time and the temperature.

For some of the dishes you can also cook with:

- Food Sensor

The degree to which a dish is cooked:

- Rare or Less
- Medium
- Well done or More



Step 1	Turn on the oven.
Step 2	Press: 
Step 3	Press:  . Enter: Assisted Cooking.
Step 4	Choose a dish or a food type.
Step 5	Press: START .







Take a shortcut!





7.3 Heating functions

STANDARD







Heating function	Application
 <p>Grill</p>	To grill thin pieces of food and to toast bread.
 <p>Turbo Grilling</p>	To roast large meat joints or poultry with bones on one shelf position. To make gratins and to brown.

Heating function	Application
 <p>True Fan Cooking</p>	To bake on up to three shelf positions at the same time and to dry food. Set the temperature 20 - 40 °C lower than for Conventional Cooking.
 <p>Frozen Foods</p>	To make convenience food (e.g., french fries, potato wedges or spring rolls) crispy.
 <p>Conventional Cooking</p>	To bake and roast food on one shelf position.
 <p>Pizza Function</p>	To bake pizza. To make intensive browning and a crispy bottom.
 <p>Bottom Heat</p>	To bake cakes with crispy bottom and to preserve food.
 <p>Bread Baking</p>	Use this function to prepare bread and bread rolls with a very good professional-like result in terms of crispiness, colour and crust gloss.
 <p>Dough Proving</p>	To speed up the rising of the yeast dough. It prevents dough surface from drying and keeps the dough elastic.

SPECIALS

Heating function	Application
 <p>Preserving</p>	To preserve vegetables (e.g., pickles).
 <p>Dehydrating</p>	To dry sliced fruit, vegetables and mushrooms.

CLOCK FUNCTIONS

Heating function	Application
 Plate Warming	To preheat plates for serving.
 Defrost	To defrost food (vegetables and fruit). The defrosting time depends on the amount and size of the frozen food.
 Au Gratin	For dishes such as lasagna or potato gratin. To make gratins and to brown.
 Slow Cooking	To prepare tender, succulent roasts.
 Keep Warm	To keep food warm.
 Moist Fan Baking	This function is designed to save energy during cooking. When you use this function, the temperature in the cavity may differ from the set temperature. The residual heat is used. The heating power may be reduced. For more information refer to "Daily Use" chapter, Notes on: Moist Fan Baking.

7.4 Notes on: Moist Fan Baking

This function was used to comply with the energy efficiency class and ecodesign requirements according to EU 65/2014 and EU 66/2014. Tests according to EN 60350-1.

The oven door should be closed during cooking so that the function is not interrupted and the oven operates with the highest energy efficiency possible.

When you use this function the lamp automatically turns off after 30 sec.

For the cooking instructions refer to "Hints and tips" chapter, Moist Fan Baking. For general energy saving recommendations refer to "Energy Efficiency" chapter, Energy Saving.

8. CLOCK FUNCTIONS

8.1 Clock functions description

Clock function	Application
Cooking time	To set the length of cooking. Maximum is 23 h 59 min.

Clock function	Application
End action	To set what happens when the timer ends counting.
Delayed start	To postpone the start and / or end of cooking.
Time extension	To extend cooking time.
Reminder	To set a countdown. Maximum is 23 h 59 min. This function has no effect on the operation of the oven.
Uptimer	Monitors how long the function operates. Uptimer - you can turn it on and off.

8.2 How to set: Clock functions

How to set the clock	
Step 1	Press: Time of day.
Step 2	Set the time. Press: OK.

How to set cooking time	
Step 1	Choose the heating function and set the temperature.
Step 2	Press:  .
Step 3	Set the time. Press: OK.

Take a shortcut!



How to choose end option	
Step 1	Choose the heating function and set the temperature.

CLOCK FUNCTIONS

How to choose end option	
Step 2	Press:  .
Step 3	Set the cooking time.
Step 4	Press: ● ● ● .
Step 5	Press: End action.
Step 6	Choose the preferred: End action.
Step 7	Press: OK. Repeat the action until the display shows the main screen.

How to delay start of cooking	
Step 1	Set the heating function and the temperature.
Step 2	Press:  .
Step 3	Set the cooking time.
Step 4	Press: ● ● ● .
Step 5	Press: Delayed start.
Step 6	Choose the value.
Step 7	Press: OK. Repeat the action until the display shows the main screen.

How to extend cooking time	
When 10% of cooking time is left and the food seems not to be ready, you can extend cooking time. You can also change the heating function.	
Press +1min to extend the cooking time.	

How to change timer settings	
Step 1	Press:  .

How to change timer settings

Step 2 Set the timer value.

Step 3 Press: OK.

You can change the set time during cooking at any time.

9. HOW TO USE: ACCESSORIES

9.1 Inserting accessories

A small indentation at the top increases safety. The indentations are also anti-tip devices. The high rim around the shelf prevents cookware from slipping of the shelf.

Wire shelf:

Push the shelf between the guide bars of the shelf support.

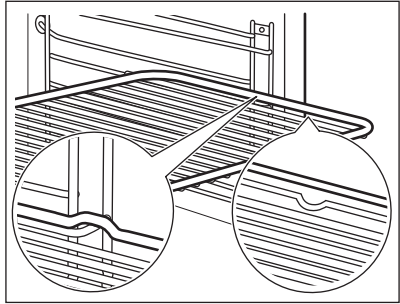

Baking tray / Deep pan:

Push the tray between the guide bars of the shelf support.

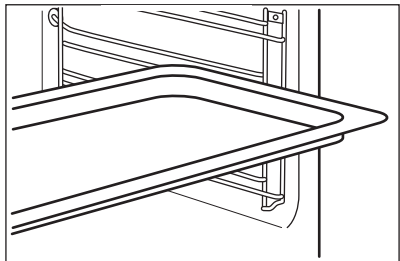

HOW TO USE: ACCESSORIES

Wire shelf, Baking tray / Deep pan:

Push the tray between the guide bars of the shelf support and the wire shelf on the guide bars above.

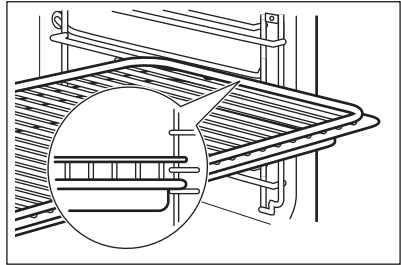

9.2 Using Trivet and Grill- / Roasting pan



WARNING!

Be careful when you remove the accessories from a hot oven. There is a risk of burns.

You can use the trivet to roast larger pieces of meat or poultry on one shelf position.

Step 1

Put the trivet into the deep pan so that the supports of the wire shelf point up.

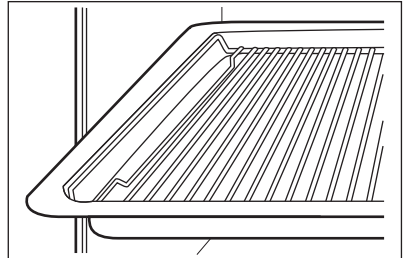

Step 2

Put the deep pan into the oven on the necessary shelf position.

You can use the trivet to grill flat dishes in large quantities and to toast.

Step 1

Put the trivet into the deep pan so that the supports of the wire shelf point down.

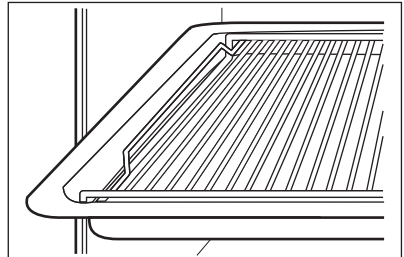



Step 2

Put the deep pan into the oven on the necessary shelf position.

9.3 Food Sensor

Food Sensor- measures the temperature inside the food. You can use it with every heating function.

There are two temperatures to be set:	
 The oven temperature: minimum 120 °C.	 The core temperature.



For the best cooking results:		
Ingredients should be at room temperature.	Do not use it for liquid dishes.	During cooking it must remain in the dish.

The oven calculates an approximate end of cooking time. It depends on the quantity of food, the set oven function and the temperature.

How to use: Food Sensor

Step 1	Turn on the oven.
Step 2	Set a heating function and, if necessary, the oven temperature.
Step 3	Insert: Food Sensor.
Meat, poultry and fish	Casserole
Insert the tip of Food Sensor into the centre of meat, fish, in the thickest part if possible. Make sure that at least 3/4 of Food Sensor is inside of the dish.	Insert the tip of Food Sensor exactly in the centre of the casserole. Food Sensor should be stabilized in one place during baking. Use a solid ingredient to achieve that. Use the rim of the baking dish to support the silicone handle of Food Sensor. The tip of Food Sensor should not touch the bottom of a baking dish.

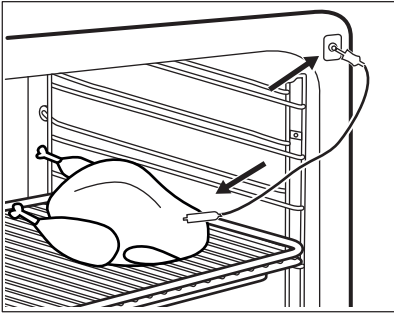
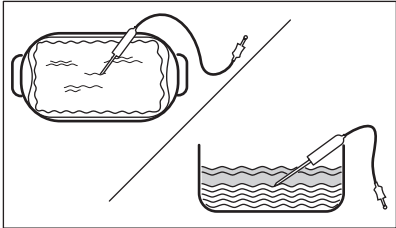
HOW TO USE: ACCESSORIES

	
Step 4	Plug Food Sensor into the socket at the front of the oven. The display shows the current temperature of: Food Sensor.
Step 5	 - press to set the core temperature of the sensor.
Step 6	<ul style="list-style-type: none"> ● ● ● - press to set the preferred option: <ul style="list-style-type: none"> • Sound alarm - when food reaches the core temperature, the signal sounds. • Sound alarm and stop cooking - when food reaches the core temperature, the signal sounds and the oven stops.
Step 7	Select the option and repeatedly press: OK to go to main screen.
Step 8	Press: START . When food reaches the set temperature, the signal sounds. You can choose to stop or to continue cooking to make sure the food is well done.
Step 9	Remove Food Sensor plug from the socket and remove the dish from the oven. <div style="border: 1px solid black; padding: 5px; margin-top: 10px;">  <p>WARNING! There is a risk of burns as Food Sensor becomes hot. Be careful when you unplug it and remove it from the food.</p> </div>



Take a shortcut!



10. ADDITIONAL FUNCTIONS



10.1 How to save: Favourites

You can save your favourite settings, such as the heating function, the cooking time, the temperature or the cleaning function. You can save 3 favourite settings.

Step 1	Turn on the oven.
Step 2	Select the preferred setting.
Step 3	Press:  . Select: Favourites.
Step 4	Select: Save current settings.
Step 5	Press + to add the setting to the list of: Favourites. Press OK.
<p> - press to reset the setting.</p> <p> - press to cancel the setting.</p>	



10.2 Function lock

This function prevents an accidental change of the heating function.



Step 1	Turn on the oven.
Step 2	Set a heating function.
Step 3	 ,  - press at the same time to turn on the function.
To turn off the function repeat step 3.	

10.3 Automatic switch-off

For safety reasons the oven turns off after some time, if a heating function works and you do not change any settings.

 (°C)	 (h)
30 - 115	12.5
120 - 195	8.5
200 - 245	5.5

HINTS AND TIPS

 (°C)	 (h)
250 - maximum	3

The Automatic switch-off does not work with the functions: Light, Food sensor, End time, Slow Cooking.

10.4 Cooling fan

When the oven operates, the cooling fan turns on automatically to keep the surfaces of the oven cool. If you turn off the oven, the cooling fan can continue to operate until the oven cools down.





11. HINTS AND TIPS





11.1 Cooking recommendations

<p>The temperature and cooking times in the tables are guidelines only. They depend on the recipes and the quality and quantity of the ingredients used.</p> <p>Your oven may bake or roast differently to the oven you had before. The tables below show recommended settings for temperature, cooking time and shelf position for specific types of the food. If you cannot find the settings for a special recipe, look for the similar one.</p> <p>For more cooking recommendations refer to cooking tables on our website. To find the Cooking Hints check the PNC number on the rating plate on the front frame of the oven cavity.</p>

11.2 Moist Fan Baking



For the best results follow suggestions listed in the table below.

		 (°C)		 (min)
Sweet rolls, 16 pieces	baking tray or dripping pan	180	2	25 - 35
Swiss Roll	baking tray or dripping pan	180	2	15 - 25
Whole fish, 0.2 kg	baking tray or dripping pan	180	3	15 - 25

		 (°C)		 (min)
Cookies, 16 pieces	baking tray or dripping pan	180	2	20 - 30
Macaroons, 24 pieces	baking tray or dripping pan	160	2	25 - 35
Muffins, 12 pieces	baking tray or dripping pan	180	2	20 - 30
Savory pastry, 20 pieces	baking tray or dripping pan	180	2	20 - 30
Short crust biscuits, 20 pieces	baking tray or dripping pan	140	2	15 - 25
Tartlets, 8 pieces	baking tray or dripping pan	180	2	15 - 25

11.3 Moist Fan Baking - recommended accessories

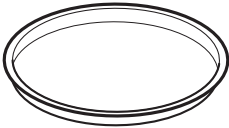
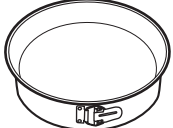
Use the dark and non-reflective tins and containers. They have better heat absorption than the light colour and reflective dishes.

			
Pizza pan	Baking dish	Ramekins	Flan base tin
Dark, non-reflective 28 cm diameter	Dark, non-reflective 26 cm diameter	Ceramic 8 cm diameter, 5 cm height	Dark, non-reflective 28 cm diameter

11.4 Cooking tables for test institutes





Information for test institutes

Tests according to: EN 60350, IEC 60350.

HINTS AND TIPS



BAKING ON ONE LEVEL. Baking in tins





		 (°C)	 (min)	
Fatless sponge cake	True Fan Cooking	140 - 150	35 - 50	2
Fatless sponge cake	Conventional Cooking	160	35 - 50	2
Apple pie, 2 tins Ø20 cm	True Fan Cooking	160	60 - 90	2
Apple pie, 2 tins Ø20 cm	Conventional Cooking	180	70 - 90	1



BAKING ON ONE LEVEL. Biscuits







Use the third shelf position.

		 (°C)	 (min)
Short bread / Pastry strips	True Fan Cooking	140	25 - 40
Short bread / Pastry strips, preheat the empty oven	Conventional Cooking	160	20 - 30
Small cakes, 20 per tray, preheat the empty oven	True Fan Cooking	150	20 - 35
Small cakes, 20 per tray, preheat the empty oven	Conventional Cooking	170	20 - 30

CARE AND CLEANING



MULTILEVEL BAKING. Biscuits

		 (°C)	 (min)	
Short bread / Pastry strips	True Fan Cooking	140	25 - 45	1 / 4
Small cakes, 20 per tray, preheat the empty oven	True Fan Cooking	150	23 - 40	1 / 4
Fatless sponge cake	True Fan Cooking	160	35 - 50	1 / 4







GRILL



Preheat the empty oven for 5 minutes.



Grill with the maximum temperature setting.

		 (min)	
Toast	Grill	1 - 3	5
Beef steak, turn halfway through	Grill	24 - 30	4

12. CARE AND CLEANING





WARNING!

Refer to Safety chapters.

CARE AND CLEANING

12.1 Notes on cleaning

 Cleaning Agents	Clean the front of the oven with a soft cloth with warm water and a mild detergent.
	Use a cleaning solution to clean metal surfaces.
	Clean stains with a mild detergent.
 Everyday Use	Clean the cavity after each use. Fat accumulation or other residue may cause fire.
	Do not store the food in the oven for longer than 20 minutes. Dry the cavity with a soft cloth after each use.
 Accessories	Clean all accessories after each use and let them dry. Use a soft cloth with warm water and a mild detergent. Do not clean the accessories in a dishwasher.
	Do not clean the non-stick accessories using abrasive cleaner or sharp-edged objects.

12.2 How to remove: Shelf supports

Remove the shelf supports to clean the oven.

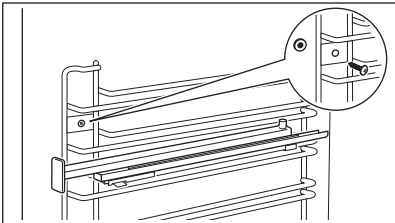
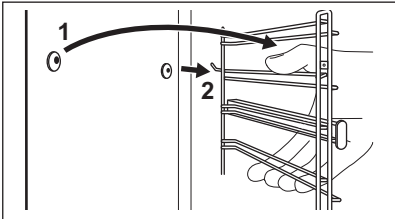
Step 1	Turn off the oven and wait until it is cold.	
Step 2	Loosen the screw. Pull the front of the shelf support away from the side wall.	
Step 3	Pull the rear end of the shelf support away from the side wall and remove it.	
Step 4	Install the shelf supports in the opposite sequence.	

12.3 How to use: Pyrolytic Cleaning

Clean the oven with Pyrolytic Cleaning.



WARNING!

There is a risk of burns.



CAUTION!

If there are other appliances installed in the same cabinet, do not use them at the same time as this function. It can cause damage to the oven.

Before the Pyrolytic Cleaning:

Turn off the oven and wait until it is cold.	Remove all accessories except for shelf supports and telescopic runners.	Clean the oven floor and the inner door glass with warm water, a soft cloth and a mild detergent.
--	--	---

Step 1	Step 2	Step 3
Turn on the oven.	Press: / Cleaning.	Select the cleaning mode.
Option	Cleaning mode	Duration
Pyrolytic cleaning, quick	Light cleaning	1 h
Pyrolytic cleaning, normal	Normal cleaning	1 h 30 min
Pyrolytic cleaning, intense	Thorough cleaning	3 h

When the cleaning starts, the oven door is locked and the lamp is off. The cooling fan works at a higher speed.

STOP - press to stop the cleaning before it is completed.
Do not use the oven until the door lock symbol disappears from the display.

When the cleaning ends:

Turn off the oven and wait until it is cold.	Clean the cavity with a soft cloth.	Remove the residue from the bottom of the cavity.
--	-------------------------------------	---

12.4 Cleaning Reminder

When the reminder appears, cleaning is recommended.

CARE AND CLEANING

Use the function: Pyrolytic Cleaning.

12.5 How to remove and install: Door

You can remove the door and the internal glass panels to clean it. The number of glass panels is different for different models.



WARNING!

The door is heavy.



CAUTION!

Carefully handle the glass, especially around the edges of the front panel. The glass can break.

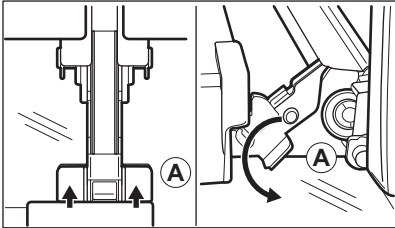
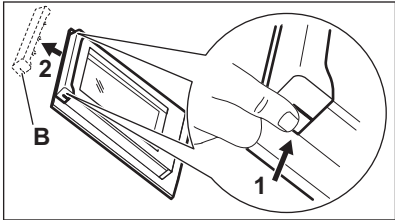
Step 1	Fully open the door.	
Step 2	Lift and press the clamping levers (A) on the two door hinges.	
Step 3	Close the oven door to the first opening position (approximately 70° angle). Hold the door at both sides and pull it away from the oven at an upwards angle. Put the door with the outer side down on a soft cloth on a stable surface.	
Step 4	Hold the door trim (B) on the top edge of the door at the two sides and push inwards to release the clip seal.	
Step 5	Pull the door trim to the front to remove it.	
Step 6	Hold the door glass panels on their top edge one by one and pull them up out of the guide.	

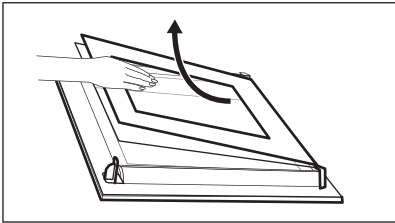
Step 7	Clean the glass panel with water and soap. Dry the glass panel carefully. Do not clean the glass panels in the dishwasher.	
Step 8	After cleaning, do the above steps in the opposite sequence.	
Step 9 Install the smaller panel first, then the larger and the door.		

12.6 How to replace: Lamp



WARNING!

Risk of electric shock.
The lamp can be hot.

Before you replace the lamp:

Step 1	Step 2	Step 3
Turn off the oven. Wait until the oven is cold.	Disconnect the oven from the mains.	Put a cloth on the bottom of the cavity.

Top lamp

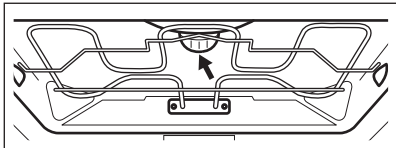
Step 1	Turn the glass cover to remove it.	
Step 2	Clean the glass cover.	
Step 3	Replace the lamp with a suitable 300 °C heat-resistant lamp.	
Step 4	Install the glass cover.	

TROUBLESHOOTING

Side lamp

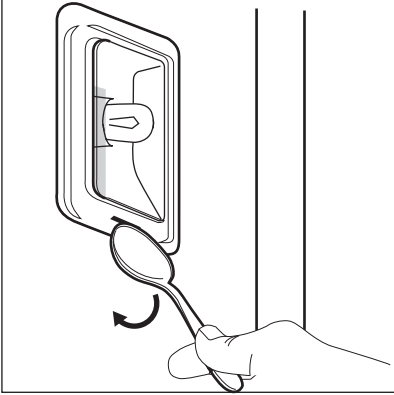
Step 1	Remove the left shelf support to get access to the lamp.	
Step 2	Use a narrow, blunt object (e.g. a teaspoon) to remove the glass cover.	
Step 3	Clean the glass cover.	
Step 4	Replace the lamp with a suitable 300 °C heat-resistant lamp.	
Step 5	Install the glass cover.	
Step 6	Install the left shelf support.	



13. TROUBLESHOOTING





WARNING!



Refer to Safety chapters.

13.1 What to do if...

 The oven does not turn on or does not heat up	
 Possible cause	 Remedy
The oven is not connected to an electrical supply or it is connected incorrectly.	Check if the oven is correctly connected to the electrical supply.
The clock is not set.	Set the clock, for details refer to "Clock Functions" chapter, How to set: Clock functions.
The door is not closed correctly.	Fully close the door.
The fuse is blown.	Make sure the fuse is the cause of the problem. If the problem recurs, contact a qualified electrician.
The oven Child Lock is on.	Refer to "Menu" chapter, Submenu for: Options.



 Components	
 Description	 Remedy
The lamp is burnt out.	Replace the lamp, for details refer to "Care and Cleaning" chapter, How to replace: Lamp.

Power cut always stops cleaning. Repeat cleaning if it's interrupted by power failure.



 Problems with Wi-Fi signal	
 Possible cause	 Remedy
Trouble with wireless network signal.	Check your wireless network and router. Restart the router.
New router installed or router configuration changed.	To configure oven and mobile device again, refer to "Before first use" chapter, Wireless connection.
The wireless network signal is weak.	Move router as close to the oven as possible.
The wireless signal is disrupted by a microwave appliance placed near the oven.	Turn off the microwave appliance.

13.2 How to manage: Error codes



When the software error occurs, the display shows error message. In this section, you will find the list of the problems that you can handle on your own.

 Code and description	 Remedy
C2 - the Food sensor is in the oven cavity during Pyrolytic Cleaning.	Take out the Food sensor.
C3 - the door is not fully closed during Pyrolytic Cleaning.	Close the door.

TROUBLESHOOTING

 Code and description	 Remedy
F111 - Food sensor is not correctly inserted into the socket.	Fully plug Food sensor into the socket.
F240, F439 - the touch fields on the display do not work properly.	Clean the surface of the display. Make sure there is no dirt on the touch fields.
F601 - there is a problem with Wi-Fi signal.	Check your network connection. Refer to "Before first use" chapter, Wireless connection.
F604 - the first connection to Wi-Fi failed.	Turn the oven off and on and try again. Refer to "Before first use" chapter, Wireless connection.
F908 - the oven system cannot connect with the control panel.	Turn the oven off and on.

When one of these error messages continues to appear on the display, it means a faulty subsystem may have been disabled. In such a case contact your dealer or an Authorized Service Centre. If one of these errors occurs, the rest of the oven functions will continue to work as usually.

 Code and description	 Remedy
F602, F603 - Wi-Fi is not available.	Turn the oven off and on.

13.3 Service data

If you cannot find a solution to the problem yourself, contact your dealer or an Authorised Service Centre.

The necessary data for the service centre is on the rating plate. The rating plate is on the front frame of the oven cavity. Do not remove the rating plate from the oven cavity.

We recommend that you write the data here:	
Model (MOD.)
Product number (PNC)
Serial number (S.N.)

14. ENERGY EFFICIENCY

14.1 Product Information and Product Information Sheet*

Supplier's name	AEG
Model identification	BPK74378PT 944188553
Energy Efficiency Index	61.2
Energy efficiency class	A++
Energy consumption with a standard load, conventional mode	1.09 kWh/cycle
Energy consumption with a standard load, fan-forced mode	0.52 kWh/cycle
Number of cavities	1
Heat source	Electricity
Volume	71 l
Type of oven	Built-In Oven
Mass	38.0 kg

* For European Union according to EU Regulations 65/2014 and 66/2014.
 For Republic of Belarus according to STB 2478-2017, Appendix G; STB 2477-2017, Annexes A and B.
 For Ukraine according to 568/32020.

Energy efficiency class is not applicable for Russia.

EN 60350-1 - Household electric cooking appliances - Part 1: Ranges, ovens, steam ovens and grills - Methods for measuring performance.

14.2 Energy saving



The oven has features which help you save energy during everyday cooking.

Make sure that the oven door is closed when the oven operates. Do not open the oven door too often during cooking. Keep the door gasket clean and make sure it is well fixed in its position. Use metal cookware to improve energy saving. When possible, do not preheat the oven before cooking.

MENU STRUCTURE

Keep breaks between baking as short as possible when you prepare a few dishes at one time.

Cooking with fan

When possible, use the cooking functions with fan to save energy.

Residual heat

If a programme with the Duration or End Time selection is activated and the cooking time is longer than 30 min, the heating elements automatically turn off earlier in some oven functions. The fan and lamp continue to operate. When you turn off the oven, the display shows the residual heat. You can use that heat to keep the food warm.

When the cooking duration is longer than 30 min, reduce the oven temperature to minimum 3 - 10 min before the end of cooking. The residual heat inside the oven will continue to cook. Use the residual heat to warm up other dishes.

Keep food warm

Choose the lowest possible temperature setting to use residual heat and keep a meal warm. The residual heat indicator or temperature appears on the display.

Cooking with the lamp off

Turn off the lamp during cooking. Turn it on only when you need it.

Moist Fan Baking

Function designed to save energy during cooking.

When you use this function the lamp automatically turns off after 30 sec. You may turn on the lamp again but this action will reduce the expected energy savings.

15. MENU STRUCTURE

15.1 Menu

Press  to open Menu.

Menu item		Application
Assisted Cooking		Lists automatic programmes.
Cleaning		Lists cleaning programmes.
Favourites		Lists the favourite settings.
Options		To set the oven configuration.
Settings	Connections	To set the network configuration.
	Setup	To set the oven configuration.
	Service	Shows the software version and configuration.

15.2 Submenu for: Cleaning

Submenu	Application
Pyrolytic cleaning, quick	Duration: 1 h.
Pyrolytic cleaning, normal	Duration: 1 h 30 min.
Pyrolytic cleaning, intense	Duration: 3 h.

15.3 Submenu for: Options

Submenu	Application
Light	Turns the lamp on and off.
Child Lock	Prevents accidental activation of the oven. When the option is on, the text "Child Lock" appears on the display when you turn on the oven. To enable the oven use, choose the code letters in the alphabetical order. When the Child Lock is on and the oven is turned off the oven door is locked. Access to the timer, the remote operation and the lamp is available with the Child Lock on.
Fast Heat Up	Shortens heat up time. It is available only for some of the oven functions.
Cleaning Reminder	Turns the reminder on and off.
Time indication	Turns the clock on and off.
Digital clock style	Changes the format of the displayed time indication.

15.4 Submenu for: Connections

Submenu	Description
Wi-Fi	To enable and disable: Wi-Fi.
Remote operation	To enable and disable remote control. Option visible only after you turn on: Wi-Fi.

MENU STRUCTURE

Submenu	Description
Auto remote operation	To start remote operation automatically after pressing START. Option visible only after you turn on: Wi-Fi.
Network	To check network status and the signal power of: Wi-Fi.
Forget network	To disable current network from auto connection with the oven.

15.5 Submenu for: Setup

Submenu	Description
Language	Sets the oven language.
Display brightness	Sets the display brightness.
Key tones	Turns the tone of the touch fields on and off. It is not possible to mute the tone for: ①.
Buzzer volume	Sets the volume of key tones and signals.
Time of day	Sets the current time and date.

15.6 Submenu for: Service

Submenu	Description
Demo mode	Activation / deactivation code: 2468
Software version	Information about software version.
Reset all settings	Restores factory settings.

16. IT'S EASY!



Before first use you have to set:

Language	Display brightness	Key tones	Buzzer volume	Time of day
----------	--------------------	-----------	---------------	-------------



Familiarize yourself with the basic icons on the control panel and the display:

 ON / OFF	 Menu	 Favourites	 Wi-Fi	 Timer	 Food sensor	START / STOP
---	---	---	--	--	--	--------------

Start using the oven

Quick start	Turn on the oven and start cooking with the default temperature and time of the function.	Step 1	Step 2	Step 3
		Press and hold: 	 ... - select the preferred function.	Press: START .
Quick Off	Turn off the oven, any screen or message at any time.	 - press and hold until the oven turns off.		



Start cooking

Step 1	Step 2	Step 3	Step 4	Step 5
 - press to turn on the oven.	 ... - select the heating function.	 - set the temperature.	OK - press to confirm.	START - press to start cooking.

Get to know how to cook quickly

Use the automatic programmes to prepare a dish quickly with the default settings:

IT'S EASY!

Get to know how to cook quickly				
Assisted Cooking	Step 1	Step 2	Step 3	Step 4
		Press:  .	Press:  .	Press:  Assisted Cooking.

Use quick functions to set the cooking time	
10% Finish assist Use 10% Finish assist to add extra time when 10% of the cooking time is left.	To extend the cooking time press +1min .

17. TAKE A SHORTCUT!

Here you can see all the useful shortcuts. You can also find them in the dedicated chapters in the user manual.

Wireless connection



How to set: Heating functions



How to set: Assisted cooking



How to set: Cooking time



How to delay: Start and end of cooking



How to cancel: Set Timer



How to use: Food Sensor



18. WARRANTY

FOR SALES IN AUSTRALIA AND NEW ZEALAND
ALL AEG BRANDED APPLIANCES

This document sets out the terms and conditions of the product warranties for AEG Appliances. It is an important document. Please keep it with your proof of purchase documents in a safe place for future reference should there be a manufacturing defect in your Appliance. This warranty is in addition to other rights you may have under the Australian Consumer Law.

1. In this warranty:

- a) 'ACL' or 'Australian Consumer Law' means Schedule 2 to the Competition and Consumer Act 2010;
 - b) 'Appliance' means any Electrolux product purchased by you and accompanied by this document;
 - c) 'ASC' means Electrolux's authorised serviced centres;
 - d) 'AEG' is the brand controlled by Electrolux Home Products Pty Ltd of 163 O'Riordan Street, Mascot NSW 2020, ABN 51 004 762 341 in respect of Appliances purchased in Australia and Electrolux (NZ) Limited (collectively "Electrolux") of 3-5 Niall Burgess Road, Mount Wellington, in respect of Appliances purchased in New Zealand;
 - e) 'Warranty Period' means the period specified in clause 3 of this warranty;
 - f) 'you' means the purchaser of the Appliance not having purchased the Appliance for resale, and 'your' has a corresponding meaning.
2. **Application:** This warranty only applies to new Appliances, purchased and used in Australia or New Zealand and is in addition to (and does not exclude, restrict, or modify in any way) other rights and remedies under a law to which the Appliances or services relate, including any non-excludable statutory guarantees in Australia and New Zealand.
 3. **Warranty Period:** Subject to these terms and conditions, this warranty continues for in Australia for a period of 60 months and in New Zealand for a period of 60 months, following the date of original purchase of the Appliance.
 4. **Repair or replace warranty:** During the Warranty Period, Electrolux or its ASC will, at no extra charge if your Appliance is readily accessible for service, without special equipment and subject to these terms and conditions, repair or replace any parts which it considers to be defective. Electrolux may, in its absolute discretion, choose whether the remedy offered for a valid warranty claim is repair or replacement. Electrolux or its ASC may use refurbished parts to repair your Appliance. You agree that any replaced Appliances or parts become the property of Electrolux.
 5. **Travel and transportation costs:** Subject to clause 7, Electrolux will bear the reasonable cost of transportation, travel and delivery of the Appliance to and from Electrolux or its ASC. Travel and transportation will be arranged by Electrolux as part of any valid warranty claim.
 6. **Proof of purchase** is required before you can make a claim under this warranty.

WARRANTY

7. **Exclusions:** You may not make a claim under this warranty unless the defect claimed is due to faulty or defective parts or workmanship. This warranty does not cover:
- light globes, batteries, filters or similar perishable parts;
 - parts and Appliances not supplied by Electrolux;
 - cosmetic damage which does not affect the operation of the Appliance;
 - damage to the Appliance caused by:
 - negligence or accident;
 - misuse or abuse, including failure to properly maintain or service;
 - improper, negligent or faulty servicing or repair works done by anyone other than an Electrolux authorised repairer or ASC;
 - normal wear and tear;
 - power surges, electrical storm damage or incorrect power supply;
 - incomplete or improper installation;
 - incorrect, improper or inappropriate operation;
 - insect or vermin infestation;
 - failure to comply with any additional instructions supplied with the Appliance;
- In addition, Electrolux is not liable under this warranty if:
- the Appliance has been, or Electrolux reasonably believes that the Appliance has been, used for purposes other than those for which the Appliance was intended, including where the Appliance has been used for any non-domestic purpose;
 - the Appliance is modified without authority from Electrolux in writing;
 - the Appliance's serial number or warranty seal has been removed or defaced.
8. **How to claim under this warranty:** To enquire about claiming under this warranty, please follow these steps:
- carefully check the operating instructions, user manual and the terms of this warranty;
 - have the model and serial number of the Appliance available;
 - have the proof of purchase (e.g. an invoice) available;
 - telephone the numbers shown below.
9. **Australia:** For Appliances and services provided by Electrolux in Australia: Electrolux goods come with guarantees that cannot be excluded under the Australian Consumer Law. You are entitled to a replacement or refund for a major failure and for compensation for any other reasonably foreseeable loss or damage. You are also entitled to have the Appliance repaired or replaced if the Appliance fails to be of acceptable quality and the failure does not amount to a major failure. 'Acceptable quality' and 'major failure' have the same meaning as referred to in the ACL.
10. **New Zealand:** For Appliances and services provided by Electrolux in New Zealand, the Appliances come with a guarantee by Electrolux pursuant to the provisions of the Consumer Guarantees Act, the Sale of Goods Act and the Fair Trading Act. Where the Appliance was purchased in New Zealand for commercial purposes the Consumer Guarantee Act does not apply.
11. **Confidentiality:** You accept that if you make a warranty claim, Electrolux and its agents including ASC may exchange information in relation to you to enable Electrolux to meet its obligations under this warranty.



Important Notice
Before calling for service, please ensure that the steps listed in clause 8 above have been followed.

SERVICE AUSTRALIA aeg.com/au	
<p>FOR SERVICE</p> <p>or to find the address of your nearest authorised service centre in Australia</p> <p>PLEASE CALL 1300 363 664</p> <p>OR EMAIL</p> <p>customercare@aegaustralia.com.au</p> <p>For the cost of a local call (Australia only)</p>	<p>FOR SPARE PARTS</p> <p>or to find the address of your nearest spare parts centre in Australia</p> <p>PLEASE CALL 13 13 50</p> <p>OR EMAIL</p> <p>customercare@aegaustralia.com.au</p> <p>For the cost of a local call (Australia only)</p>

SERVICE NEW ZEALAND aegnewzealand.co.nz	
<p>FOR SERVICE</p> <p>or to find the address of your nearest authorised service centre in New Zealand</p> <p>PLEASE CALL 0800 234 234</p> <p>OR EMAIL</p> <p>customercare@electrolux.co.nz</p> <p>(New Zealand only)</p>	<p>FOR SPARE PARTS</p> <p>or to find the address of your nearest spare parts centre in New Zealand</p> <p>PLEASE CALL 0800 10 66 20</p> <p>OR EMAIL</p> <p>customercare@electrolux.co.nz</p> <p>(New Zealand only)</p>

AEG_Warr_May_17

19. ENVIRONMENTAL CONCERNS

Recycle materials with the symbol . Put the packaging in relevant containers to recycle it. Help protect the environment and human health by recycling waste of electrical and electronic appliances. Do not dispose of appliances marked with the symbol  with the household waste. Return the product to your local recycling facility or contact your municipal office.





