OWNER'S GUIDE

READ AND SAVE THESE INSTRUCTIONS

AIR CONDITIONER

ELECTRONIC CONTROL

ROOM AIR CONDITIONER WARRANTY

Your product is protected by this warranty

Your appliance is warranted by White Consolidated Industries, Inc. WCI has authorized Frigidaire Consumer Services and their authorized servicers to perform service under this warranty. WCI authorizes no one else to change or add to any of these obligations under this warranty. Any obligations for service and parts under this warranty must be performed by Frigidaire Consumer Services or an authorized Frigidaire servicer.

	WARRANTY PERIOD	FRIGIDAIRE, THROUGH ITS AUTHORIZED SERVICERS, WILL:	THE CONSUMER WILL BE RESPONSIBLE FOR:
FULL ONE-YEAR WARRANTY	One year from original purchase date.	Pay all costs for repairing or replacing parts of this appliance which prove to be defective in materials or workmanship.	Costs of service calls that are listed under NORMAL RESPONSIBILITIES OF THE CONSUMER.*
LIMITED 2ND-5TH YEAR WARRANTY (Sealed System)	Second through fifth years from original purchase date.	Repair or replace any parts in the Sealed Refrigeration System (compressor, condenser, evaporator and tubing) that proves to be defective in materials or workmanship.	Diagnostic costs and any removal, transportation and reinstallation costs which are required because of service. Costs for labor, parts and transportation other than with respect to the Sealed Refrigeration System.
LIMITED WARRANTY (Applicable to the State of Alaska)	Time periods listed above.	All of the provisions of the full and limited warranties above and the exclusions listed below apply.	Costs of the technician's travel to the home and any costs for pick up and delivery of the appliance required because of service.

*NORMAL RESPONSIBILITIES OF THE CONSUMER

This warranty applies only to products in ordinary household use, and the consumer is responsible for the items listed below.

1. Proper use of the appliance in accordance with instructions provided with the product.
2. Proper installation by an authorized servicer in accordance with instructions provided with the appliance and in accordance with all local plumbing, electrical and/or gas codes.
3. Proper connection to a grounded power supply of sufficient voltage, replacement of blown fuses, repair of loose connections or defects in house wiring.
4. Expenses for making the appliance accessible for servicing, such as removal of trim, cupboards, shelves, etc., which are not a part of the appliance when it was shipped from the factory.
5. Damages to finish after installation.
6. Replacement of light bulbs and/or fluorescent tubes (on models with these features).

EXCLUSIONS

This warranty does not cover the following:

1. CONSEQUENTIAL OR INCIDENTAL DAMAGES SUCH AS PROPERTY DAMAGE AND INCIDENTAL EXPENSES RESULTING FROM ANY BREACH OF THIS WRITTEN OR ANY IMPLIED WARRANTY.
Note: Some states do not allow the exclusion or limitation of incidental or consequential damages, so this limitation or exclusion may not apply to you.
2. Service calls which do not involve malfunction or defects in workmanship or material, or for appliances not in ordinary household use. The consumer shall pay for such service calls.
3. Damages caused by services performed by persons other than authorized Frigidaire servicers; use of parts other than Frigidaire Genuine Renewal Parts; obtained from persons other than such servicers; or external causes such as abuse, misuse, inadequate power supply or acts of God.
4. Products with original serial numbers that have been removed or altered and cannot be readily determined.

IF YOU NEED SERVICE

Keep your bill of sale, delivery slip, or some other appropriate payment record. The date on the bill establishes the warranty period should service be required. If service is performed, it is in your best interest to obtain and keep all receipts. This written warranty gives you specific legal rights. You may also have other rights that vary from state to state. Service under this warranty must be obtained by following these steps, in order:

1. Contact Frigidaire Consumer Services or an authorized Frigidaire servicer.
2. If there is a question as to where to obtain service, contact our Consumer Relations Department at:

Frigidaire Company
P.O. Box 212378
Augusta, GA 30917
800-444-4944



Product features or specifications as described or illustrated are subject to change without notice. All warranties are made by White Consolidated Industries, Inc. This warranty applies only in the 50 states of the U.S.A., Puerto Rico and Canada.

Product Registration

Record Your Model and Serial Numbers

Record in the space provided below the model and serial numbers. On most models, the serial plate is located on the outside of the cabinet. On some models, remove the filter and look at the bottom edge of the air conditioner behind the front grille for the model and serial numbers. Reading these numbers may be easier by using a flashlight or by removing the cabinet front as instructed under "Care and Cleaning."

Model No. _____

Serial No. _____

Register Your Product

The self-addressed PRODUCT REGISTRATION CARD should be filled in completely, signed and returned to the Frigidaire Company.

Contents

NOTE: This Owner's Guide provides specific operating instructions for your model. Use the room air conditioner only as instructed in this Owner's Guide. These instructions are not meant to cover every possible condition and situation that may occur. Common sense and caution must be practiced when installing, operating, and maintaining any appliance.

2	Warranty
3	Product Registration
3	Normal Sounds
4	Important Safety Instructions
4	Energy Saving Ideas
5	Vent/Dial Plate/Front Installation
6	Using Air Conditioner
6-11	Air Conditioner Features
11	Care and Cleaning
12	Avoid Service Checklist

Normal Sounds

Sound of Rushing Air

At the front of the unit, you may hear the sound of rushing air being moved by the fan.

Thermostat Clicking Sound

As cooling systems cycle on and off, you may hear a "clicking" sound.

High Pitched Chatter

Today's high efficient compressors may have a high pitched chatter during the cooling cycle.

Vibration

Unit may vibrate and make noise because of poor wall or window construction or incorrect installation.

Pinging or Swishing

Droplets of water hitting condenser during normal operation may cause "pinging or swishing" sounds.

Gurgle/Hiss

"Gurgling or hissing" noise may be heard due to refrigerant passing through evaporation during normal operation.

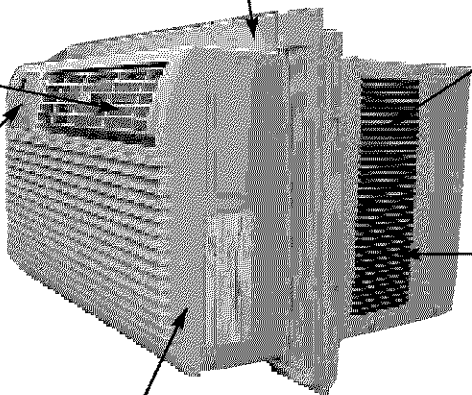

Important Safety Instructions

Read all instructions before using this air conditioner.

⚠️ WARNING For Your Safety

Do not store or use gasoline or other flammable vapors and liquids in the vicinity of this or any other appliance. Read product labels for flammability and other warnings.

⚠️ WARNING Prevent Accidents

To reduce the risk of fire, electrical shock, or injury to persons when using your air conditioner, follow basic precautions, including the following:

- Be sure the electrical service is adequate for the model you have chosen. This information can be found on the serial plate, which is located either on the side of the cabinet or behind the grille.
- If the air conditioner is to be installed in a window, you will probably want to clean both sides of the glass first. If the window is a triple-track type with a screen panel included, remove the screen completely before installation.
- Be sure the air conditioner has been securely and correctly installed according to the separate installation instructions provided with this manual. Save this manual and the installation instructions for possible future use in removing or reinstalling this unit.
- When handling the air conditioner, be careful to avoid cuts from sharp metal fins on front and rear coils.

⚠️ WARNING Electrical Information

The complete electrical rating of your new room air conditioner is stated on the serial plate. Refer to the rating when checking the electrical requirements.

- Be sure the air conditioner is properly grounded. To minimize shock and fire hazards, proper grounding is important. The power cord is equipped with a three-prong grounding plug for protection against shock hazards.
- Your air conditioner **must** be used in a properly grounded wall receptacle. If the wall receptacle you intend to use is not adequately grounded or protected by a time delay fuse or circuit breaker, have a qualified electrician install the proper receptacle.
- Do not run air conditioner with outside protective cover in place. This could result in mechanical damage within the air conditioner.
- **Do not use an extension cord or an adapter plug.**

⚠️ WARNING Avoid fire hazard or electric shock. Do not use an extension cord or an adaptor plug. Do not remove any prong from the power cord.

Grounding type wall receptacle

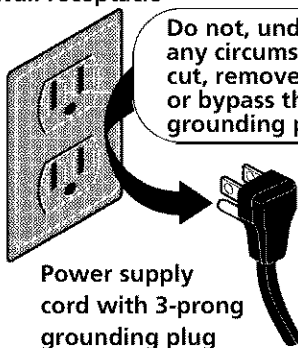

Power supply cord with 3-prong grounding plug

Energy Saving Ideas



- **Do not block air flow inside with blinds, curtains or furniture; or outside with shrubs, enclosures, or other buildings.**
- The capacity of the room air conditioner must fit the room size for efficient and satisfactory operation.
- Install the room air conditioner on the shady side of your home. A window that faces north is best because it is shaded most of the day.
- Close the fireplace damper, floor and wall registers so cool air does not escape up the chimney and into the duct work.
- Keep blinds and drapes in other windows closed during the sunniest part of the day. (This will also improve the Remote Control operation.)
- Clean the air filter as recommended in the section "Care and Cleaning."
- Proper insulation and water stripping in your home will help keep warm air out and cool air in.
- External house shading with trees, plants or awnings will help reduce the air conditioner's work load.
- Operate heat producing appliances such as ranges, washers, dryers and dishwashers during the coolest part of the day.

Front Installation

Some models are shipped in a removable sleeve, please follow the supplied Installation Instruction before installing the Decorative front and accessories.

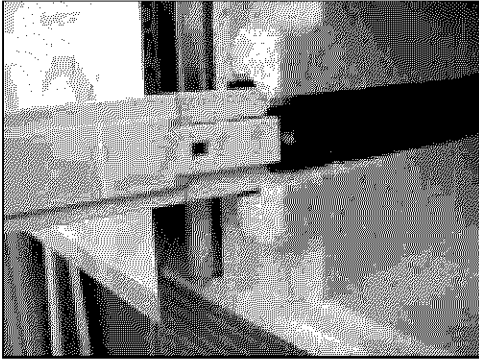

Installing the Vent Control (on some models)

The vent control handle is included in the decorative front kit. The handle must be installed before the decorative front is attached.

1. Insert the handle with the "etchings (Vent/Air)" facing to the left.
2. Slip the black door extension into the split at the end of the handle.
3. For ease of assembly, push the handle in while pressing the door extension against the foam until the two pieces lock together.
4. Move handle in and out to be sure vent is operating properly.

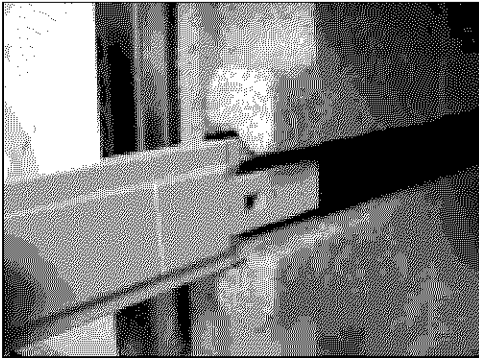

Installing the Front Frame

Some models require installation of the front panel of the air conditioner included in a decorative kit. To assemble, follow these steps. Before installation, remove the tilt panel from the frame. Grasping the panel from both sides, gently pull to release, then lift panel from pivot points at bottom of frame).

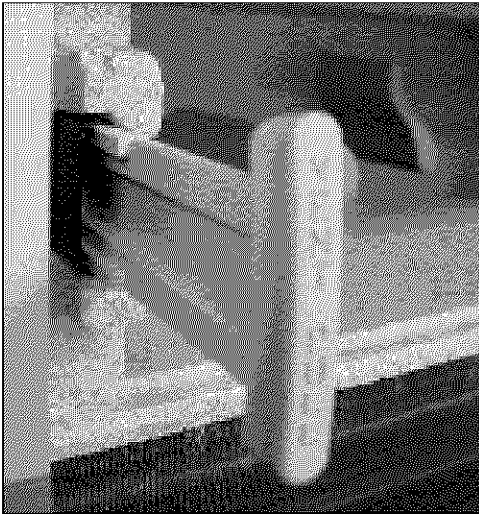

STEP 1: INSTALL DECORATIVE FRONT TO CABINET:

Decorative Front

- Loosen the screw to the left of the Electronic Control by 1/2 turn to easily install the decorative front.
- Position the top of the decorative front over the top flange of the case, and align the tabs with the slots in the case (Fig. 1).
- As you install the front frame to the unit be sure the vent handle is positioned through the front in the proper location (Fig. 2).
- Carefully pull down on the front to engage the top tabs, while pushing the front over the case to ensure proper alignment.
- The side tabs will "click" when front is seated.
- Install front retaining screw(s) behind the filter and panel (Fig. 2 & 3).
- Then add filter and front panel.
- Install behind the filter handle.

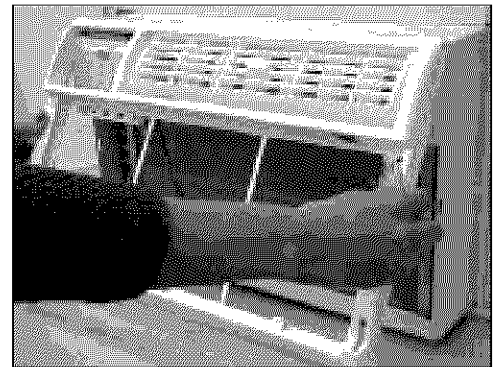

FIG. 1

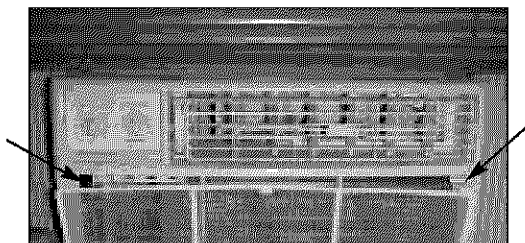

FIG. 2

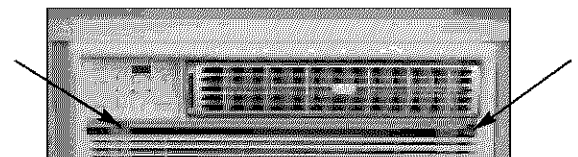

FIG. 3

Using Air Conditioner

⚠ WARNING To reduce the risk of fire, electric shock, or injury to persons, read the IMPORTANT SAFETY INSTRUCTIONS before operating this appliance.

To begin operating the air conditioner, follow these steps:

1. Plug in the air conditioner. (To prevent electrical hazards, do not use an extension cord or an adapter plug.)
 2. Set the exhaust vent to the CLOSED position.
 3. Adjust the louvers for comfortable air flow.
- Review the "Air Conditioner Features" section for other settings.

Air Conditioner Features

ELECTRONIC CONTROL OPERATING INSTRUCTIONS

Before you begin, thoroughly familiarize yourself with the control panel and remote as shown below and all its functions, then follow the symbol for the functions you desire. The unit can be controlled by the touch pad alone or with the remote.

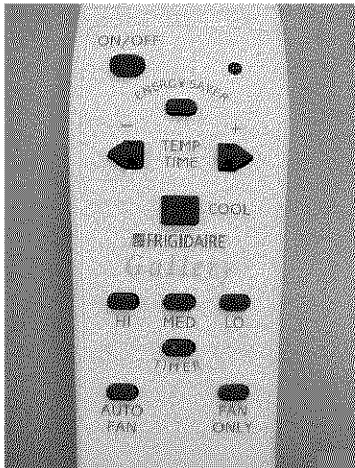

REMOTE CONTROL

LOWERS TEMPERATURE OR TIME

RAISES TEMPERATURE OR TIME

SETS HOURS

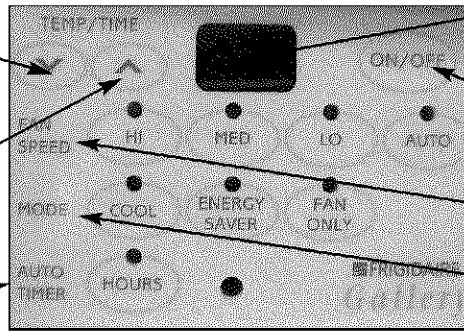

DISPLAYS TEMPERATURE/TIME

URNS UNIT ON OR OFF

SETS FAN SPEEDS

SETS MODE

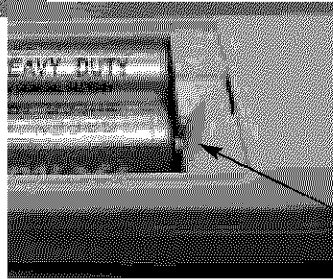

Slip battery cover off and pull the piece of plastic from between the battery end and the connector. For some applications the batteries supplied will first need to be installed.

PLASTIC PIECE

STEP 1 — TO TURN UNIT ON:

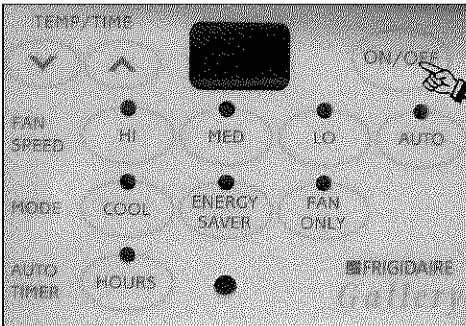

DO THIS:

PRESS ON/OFF PAD

YOU WILL SEE:

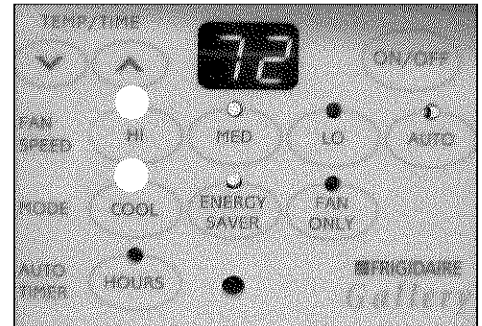

Note: Remember that in this mode, the fan will run continuously while the compressor cycles on and off as needed to maintain the room temperature. (See also, power saver mode, step 6)

Air Conditioner Features

(continued)

STEP 2 — TO CHANGE TEMPERATURE SETTING:

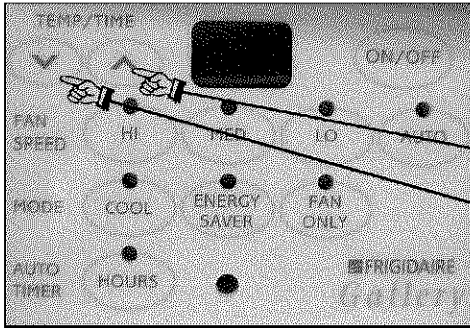

DO THIS:
PRESS TO RAISE
PRESS TO LOWER

YOU WILL SEE:

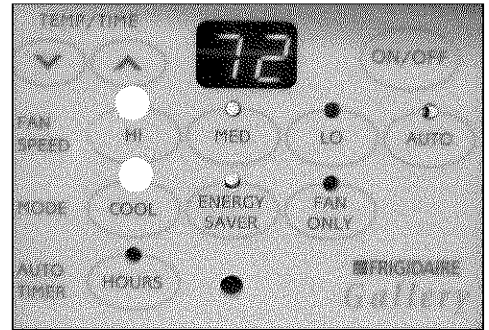

Note: Tap or hold either up(^) or down(v) button until the desired temperature is seen on the screen. This temperature will be automatically maintained anywhere between 60F (15C) and 90F (32C). If you want the display to read the actual room temperature, see step 5.

STEP 3 — TO CHANGE FAN SPEEDS:

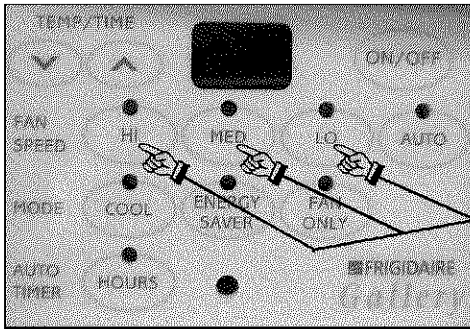

DO THIS:
PRESS WHICHEVER YOU PREFER

YOU WILL SEE (WHICHEVER YOU HAVE CHOSEN):

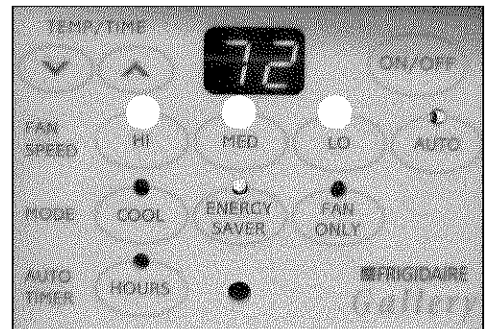

STEP 4 — TO ALLOW CONTROL TO CHOOSE FAN SPEED:

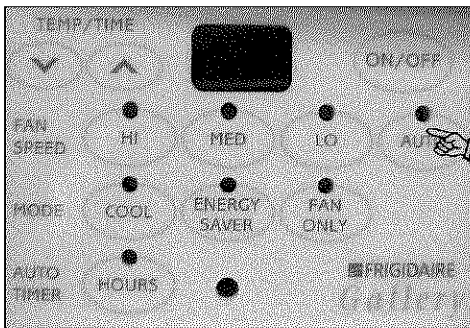

DO THIS:
PRESS AUTO

YOU WILL SEE:



Note: The fan speed will begin in HI, then adjust to MED and LO as the room temperature conditions dictate. For example, if the room doesn't get too warm it will stay at LO. If the room temperature rises quickly, such as a door being opened, it will automatically go to HI speed. The fan speeds will readjust back to LO as the room returns to the original set temperature.

Air Conditioner Features (continued)

STEP 5 — TO OPERATE ON FAN ONLY:

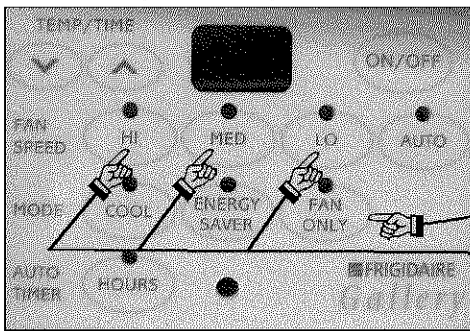

DO THIS:

- PRESS ON (if not running)
- PRESS FAN ONLY
- CHOOSE ONE

YOU WILL SEE:

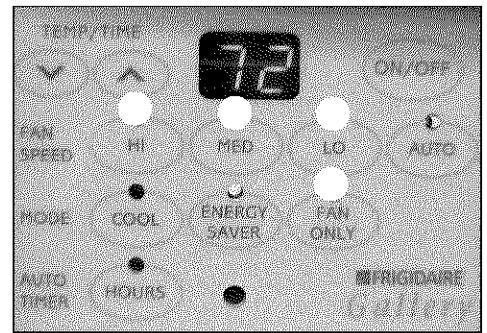

Note: Use this function only when cooling is not desired, such as for room air circulation or to exhaust stale air. (remember to open the vent during this function, but keep it closed during cooling for maximum cooling efficiency.) You can choose any fan speed you prefer. (Note: The "AUTO" setting will not operate in FAN ONLY.)

During this function, the display will show the actual room temperature, not the set temperature as in the cooling mode.

STEP 6 — TO USE THE ENERGY SAVER FEATURE:

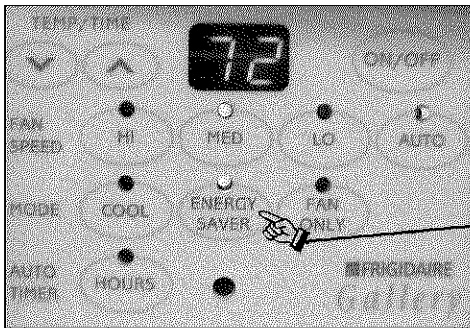

DO THIS:

- PRESS ENERGY SAVER

YOU WILL SEE:



Note: In this mode, when the compressor shuts off, the fan will continue to run for another 3 minutes, then shut off until cooling is needed, as sensed by the room temperature control. During this time, it may come on for 3 minutes to sense whether cooling is needed, then it will go off for 15 minutes. It will continue doing this to sample the room air for as long as necessary.

STEP 7 — TO SET FOR DELAYED START:

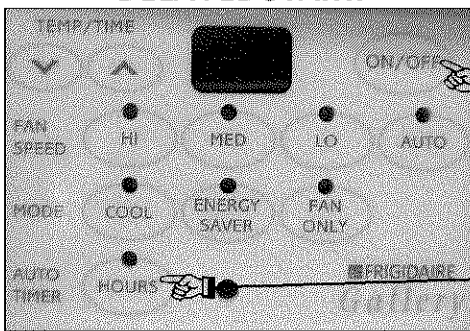

DO THIS:

- PRESS OFF (If unit is running)
- PRESS TIMER/OFF

YOU WILL SEE:

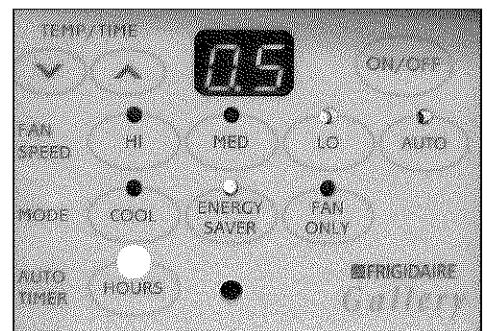

Note: To do this, the unit must be in the off position.

When first set, the display will show .5 (one half hour), to increase the time up to 24 hours, go to step 8.

Air Conditioner Features

(continued)

STEP 8 — TO INCREASE DELAYED START TIME:

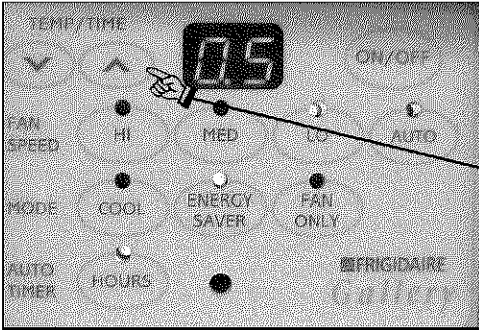

DO THIS:
PRESS

YOU WILL SEE TIME CHOSEN:

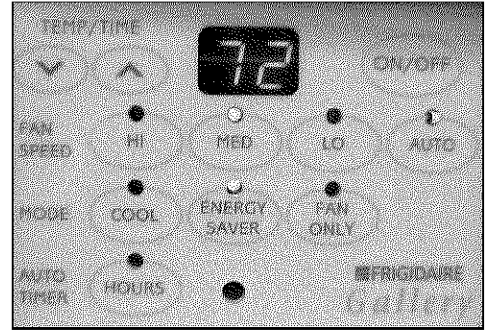

Note: Tap or hold the UP arrow (^) to increase delayed start time by .5 hours (up to 10 hours), then in 1 hour increments up to 24 hours. The control will count down the time remaining until start (8, 7.5, 7, etc.).

The unit will then come on in Cool and HI fan mode. The temperature maintained will be the same as you previously set. If you want to change it, Press 'Cool' then Up or Down arrows until the desired temperature is indicated on the display. Press Timer pad again to show remaining time.

Switching unit on at any time will nullify this setting.

STEP 9 — TO SET FOR DELAYED STOP:

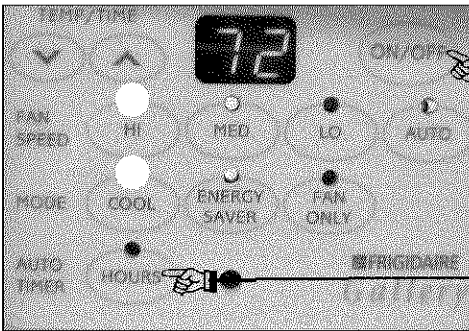

DO THIS:
PRESS
(if unit is not running)
PRESS

YOU WILL SEE:

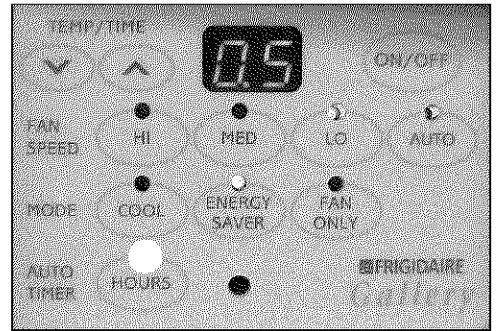

Note: The unit must be running to make this setting.

Proceed as in step 8 to change the desired number of hours. The display will then continue to show hours and continue to maintain last temperature setting until the control will time out and turn the unit off.

STEP 10 — TO TURN UNIT OFF:



DO THIS:
PRESS ON/OFF
PAD

YOU WILL SEE:

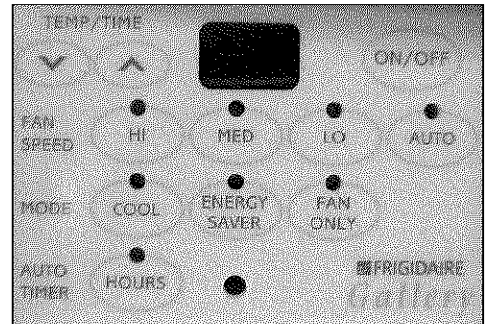

Note: The control will always maintain the last setting when it is restarted next time.

Air Conditioner Features

(continued)

ADDITIONAL THINGS YOU SHOULD KNOW

Now that you have mastered the operating procedure, here are more features in your control that you should become familiar with.

- Remote control works exactly like the control panel, follow the same instructions.
- The "Cool " circuit has an automatic 3 minute time delayed start if the unit is turned off and on quickly. This prevents overheating of the compressor and possible circuit breaker tripping. The fan will continue to run during this time.
- The control will maintain the set temperature within 2-3 degrees Fahrenheit, between 60F and 90F degrees.

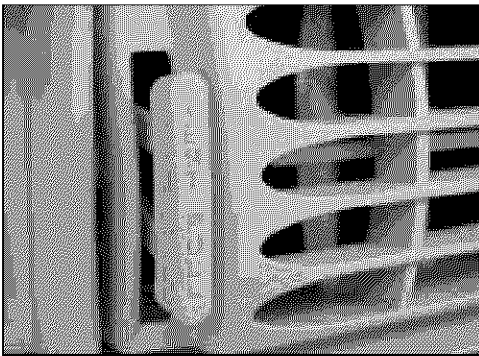

Figure 1 (OFF)

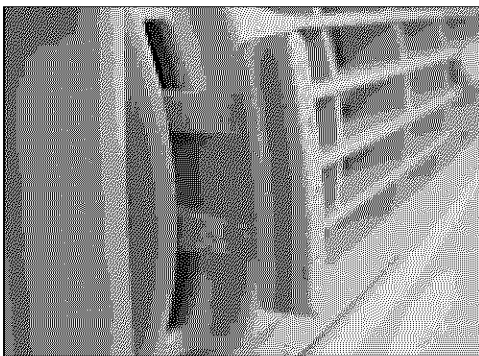

Figure 2 (FRESH AIR)

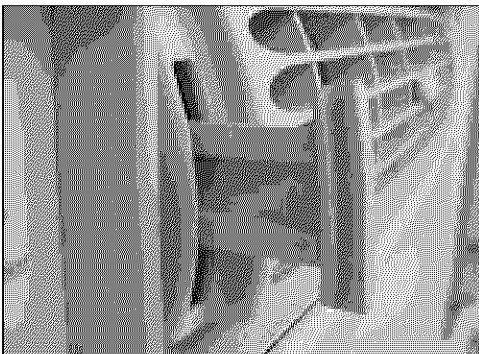

Figure 3 (VENT)

Fresh Air Vent Control

The Fresh Air Vent allows the air conditioner to recirculate inside air (OFF), draw air into the room (FRESH AIR) or exhaust stale air to the outside (VENT). See Figures 1, 2 & 3 for this operation.

- The "OFF" position is used when **MAXIMUM** cooling is desired. It may also be for room air re-circulation without cooling when the selector switch is set to the FAN position, this will also filter the room air.
- The FRESH AIR position allows outside air to be drawn into the room to refresh the inside room air.
- The VENT position removes stale air from the room and exhausts it to the outside.
- Any vent position can be used with any fan selection.

Air Conditioner Features (continued)

Air Directional Louvers

Air directional louvers control air flow direction. Your air conditioner has one of the louver types described below.

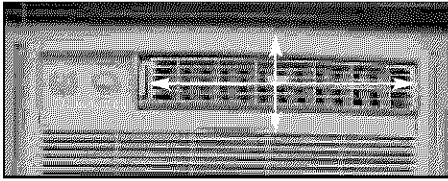

(4-WAY)

4-Way Louvers

The 4-Way air directional louvers allow you to direct air flow up or down, left or right throughout the room as needed. To adjust the air directional louvers side-to-side, use the center handle as you move it side-to-side.

Care and Cleaning

Clean your air conditioner occasionally to keep it looking new. **Be sure to unplug the unit before cleaning to prevent shock or fire hazards.**

Air Filter Cleaning

The air filter should be checked at least once a month to see if cleaning is necessary. Trapped particles in the filter can build up and cause an accumulation of frost on the cooling coils.

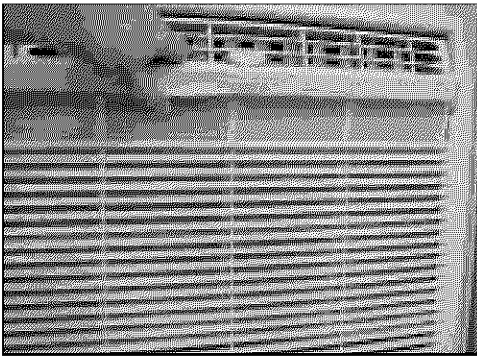

- Push the vent handle to the OFF position.
- Tilt the Horizontal Louvers in the UP position, before pulling the filter out.
- Grasp the filter by the center and pull up and out.
- On some models, first tilt the panel out by grasping the panel from both sides just below the air directional louvers and gently pull to release. Gently pivot the panel on its hinge, and remove the filter.
- Wash the filter using liquid dishwashing detergent and warm water. Rinse filter thoroughly. Gently shake excess water from the filter. Be sure filter is thoroughly dry before replacing.
- Or, instead of washing you may vacuum the filter clean.

Cabinet Cleaning

- Be sure to unplug the air conditioner to prevent shock or fire hazard. The cabinet and front may be dusted with an oil-free cloth or washed with a cloth dampened in a solution of warm water and mild liquid dishwashing detergent. Rinse thoroughly and wipe dry.
- Never use harsh cleaners, wax or polish on the cabinet front.
- Be sure to wring excess water from the cloth before wiping around the controls. Excess water in or around the controls may cause damage to the air conditioner.
- The cabinet front can be removed for more thorough cleaning. Refer to "Front Installation" in this manual.
- Clean the front in a sink using liquid dishwashing detergent and warm water. Rinse thoroughly and dry.
- Replace cabinet front. Replace the screws.
- Replace front panel (if applicable) and filter. Plug in air conditioner.

Winter Storage

If you plan to store the air conditioner during the winter, remove it carefully from the window according to the installation instructions. Cover it with plastic or return it to the original carton.

HINT: Operate unit on "FAN ONLY" for 1 hour before removing unit to dry out condensate (water) in pan.

NOTE: To prevent rust or electrical connections from being damaged, store air conditioner in an upright position and a dry place. A winter cover can be purchased from your dealer. The cover will protect the air conditioner when it is left in place through the winter.

Avoid Service Checklist

Before calling for service, review this list. It may save you time and expense. This list includes common occurrences that are not the result of defective workmanship or materials in this appliance.

OCCURRENCE	SOLUTION
Air conditioner will not operate.	Wall plug disconnected. Push plug firmly into wall outlet. Batteries in remote may need to be replaced. House fuse blown or circuit breaker tripped. Replace fuse with time delay type or reset circuit breaker. Unit is in the OFF mode. Turn "ON" to the desired FAN and/or COOL setting. Unit turned off by moving temperature to a higher number and then immediately turning back to a cooler number. Wait approximately 3 minutes. Listen for compressor to start. Temperature is set too high. Adjust temperature to a lower number for cooling.
Air from unit does not feel cold enough.	Set to a higher FAN or COOL position Temperature is set too high. Set temperature to a lower setting. Room temperature below 60°F (15°C). Cooling may not occur until room temperature rises above 60°F (15°C). Temperature sensing tube touching cold coil, located behind air filter. Be sure the sensor is in the clip, which is attached to the coil.
Air conditioner cooling, but room is too warm — ice forming on cooling coil behind decorative front.	Outdoor temperature below 60°F (15°C). To defrost the coil, set selector to FAN position. Then, set temperature warmer. Air filter may be dirty. Clean filter. Refer to Care and Cleaning section. To defrost, set selector to FAN. Temperature set too cold for night-time cooling. To defrost the coil, set selector to a FAN position. Then, set temperature warmer.
Air conditioner cooling, but room is too warm — NO ice forming on cooling coil behind decorative front.	Dirty air filter — air restricted. Clean air filter. Refer to Care and Cleaning section. Temperature is set too high. Set temperature lower. Vent set at OPEN position. Set vent at CLOSED position for maximum cooling. Air directional louvres positioned improperly. Position louvres for better air distribution. Front of unit is blocked by drapes, blinds, furniture, etc. — restricts air distribution. Clear blockage in front of unit. Doors, windows, registers, etc. open — cold air escapes. Close doors, windows, registers, etc. Unit recently turned on in hot room. Allow additional time to remove "stored heat" from walls, ceiling, floor and furniture.
Air conditioner turns on and off rapidly.	Dirty air filter — air restricted. Clean air filter. Outside temperature extremely hot. Set FAN on high speed to bring air past cooling coils more frequently.
Noise when unit is cooling.	Air movement sound. This is normal. If too loud, set to lower FAN setting. Sound of fan hitting water-moisture removal system. This is normal when humidity is high. Close doors, windows and registers. Window vibration — poor installation. Refer to installation instructions or check with installer.
Water dripping INSIDE when unit is cooling.	Improper installation. Tilt air conditioner slightly to the outside to allow water drainage. Refer to installation instructions — check with installer.
Water dripping OUTSIDE when unit is cooling.	Unit removing large quantity of moisture from humid room. This is normal during excessively humid days.