



TRUE RESIDENTIAL®

15 INCH CLEAR ICE MACHINE INSTALL GUIDE AND USER'S MANUAL



PRESERVE THE MOMENT®

A photograph showing a person's arm in a blue and white striped shirt resting on a table. The table is covered with architectural blueprints. A pen is visible on the blueprints. The background is slightly blurred, showing more of the workspace.

As a family-owned business, we believe in the importance of service, so we've always made sure that good help isn't hard to find, whether that means providing design inspiration or product information. For 70 years, we've been pioneers in cold, but we've also been leaders in warm customer service and support. We hope that this guide offers you what you need for the True Residential® products in your customers' (or your own) homes. If you don't see what you're looking for, please contact True customer service at 888-616-8783 or info@true-residential.com or you may also visit our website at true-residential.com

*Commercial refrigeration refined for the home, envied in the industry,
and crafted—gorgeously—in America.*



PRESERVE THE MOMENT*

CONTENTS

INSTALLATION CHECKLIST	7
15 INCH TRUE ICE® MACHINE MODELS	9
FEATURES OF THE TRUE ICE® MACHINE OWNERSHIP	12
SAFETY PRECAUTIONS	12
PROPER DISPOSAL AND CFC DISPOSAL	13
WARNING & SAFETY LABELS	13
UNCRATING	14
ELECTRICAL SPECIFICATIONS	15
OUTDOOR USE	15
INSTALLATION SPECIFICATIONS	18-22
INSTALLATION SPECIFICATIONS FOR SOLID PANEL AND INTEGRATED PANEL (OP)	21-25
INSTALLING DOOR STOP	26
PLUMBING CONNECTIONS	26
LEVELING ICE MACHINE	27
WATER SUPPLY	27
DRAIN CONNECTION	28
WATER FILTER	29
POSITION THE UNIT	29
PUMPING HEIGHTS	30-31
DRAIN ALARM (DRN)	32
TRUE PRECISION CONTROL® OPERATION AND TRUE ICE® MACHINE COMPONENTS BEFORE OPERATING	34-36
ICE MAKING SEQUENCE	37
POWER AND BIN LIGHT	38
CUBE SIZE ADJUSTMENT	38
BIN THERMOSTAT / ICE LEVEL ADJUSTMENTS	39
BREAKER RESET	39
WATER QUALITY SETTING	39
GENERAL MAINTENANCE	42
WATER SHUTTERS, ICE GUIDE, AND PUMP CLEAN-OUT CAP	43
SPRAY BAR DISASSEMBLY	44
WATER FILTER REPLACEMENT AND REPLACEMENT PARTS	45
CONDENSER CLEANING INSTRUCTIONS	45
STAINLESS STEEL EQUIPMENT CARE AND CLEANING	46-47
DESCALING AND SANITIZING	48-49
EXTERIOR CLEAN, WINTERIZING AND RESTART INSTRUCTIONS	49
FREQUENTLY ASKED QUESTIONS	50
WARRANTY	51-52



NOTES

INSTALLATION CHECKLIST

Use this checklist during installation to ensure that no part of the process has been overlooked.

- Has an authorized True dealer or licensed installer inspected stainless steel surfaces for imperfection? (Cosmetic defects are covered by a limited 30-day warranty)
- Have all packaging materials and tape been removed?
- Is the water temperature always between 40°F (4°C) and 100°F (38°C)?
- Is the power cord plugged into a properly grounded three-prong outlet in accordance with all applicable electrical codes?
- Have the water supply and drain connections been made?
- Has the ice machine drain line been routed into an open drain with no more than eight feet (2.4 m) of rise and 100 feet (33 m) of run?
- Is the unit leveled properly with all leveling legs making contact with the floor?
- Has the door stop been installed? (If required)
- Are panels attached securely and properly aligned? (Overlay cabinets only)
- Has the machine been set for the local water quality?
- Has the water filter been installed?
- Is the water supply turned on?
- Have the connections been checked for water leaks?
- Is the machine turned on and working properly?
- Have the first two batches of ice been discarded?
- Does the machine shut off when ice is held against the thermostat tube?
- Has the customer reviewed the unit's operation in this manual?
- Has the customer reviewed the schedule of maintenance of the machine?



NOTES

15 INCH STAINLESS STEEL

STAINLESS STEEL DOOR (SS)



15 INCH TRUE™ ICE MACHINE
TUI-15-R/L-SS-B

15 INCH OVERLAY PANEL

SOLID PANEL READY DOOR (OP)



15 INCH TRUE™ ICE MACHINE
TUI-15-R/L-OP-B

NOTES



FEATURES OF THE ICE MACHINE

OWNERSHIP

SAFETY PRECAUTIONS

PROPER DISPOSAL AND CFC DISPOSAL

WARNING & SAFETY LABELS

UNCRATING

ELECTRICAL SPECIFICATIONS

OUTDOOR USE

FEATURES OF THE TRUE™ ICE MACHINE

- Produces up to 70 pounds of ultra-clear gourmet ice cubes per day.
- Stores 28 pounds of ice cubes.
- Three-Character LED display tells you what your machine is doing.
- Auto-clean sequence for walk-away cleaning simplicity.
- Cleaning time remaining is shown on the display.
- Drain pump standard on all models.
- Built-in water filter insures that no parts are exposed to unfiltered water.
- Fourteen-Color LED bin light.
- High quality ice scoop and built-in scoop holder included.
- Automatic filter change reminder.
- UL approved for outdoor use.
- Industry-leading True Warranty on page 42.

OWNERSHIP

TO INSURE THAT YOUR UNIT WORKS PROPERLY FROM THE FIRST DAY, IT MUST BE INSTALLED PROPERLY.

NOTE: WE HIGHLY RECOMMEND A TRAINED INSTALLER, PLUMBER OR ELECTRICIAN INSTALL YOUR TRUE RESIDENTIAL® ICE MACHINE. THE COST OF A PROFESSIONAL INSTALLATION IS MONEY WELL SPENT.

Before you start to install your True Residential® Ice Machine, carefully inspect it for freight damage. If damage is discovered, immediately file a claim with the delivery freight carrier. True is not responsible for damage incurred during shipment.

Any questions about the installation please contact your True dealer or True Technical Service Department at 844-746-9423. Please have your model and serial numbers available when you call our Service Department.

SAFETY PRECAUTIONS

- This ice machine must be properly installed and located in accordance with the installation instructions before it is used.
- Do not allow children to climb, stand or hang on the ice machine. They could damage the ice machine and seriously injure themselves.
- Do not store or use gasoline or other flammable vapors and liquids in the vicinity of this or any other appliance.
- Keep hands away from the “pinch point” areas and gaps between the doors and cabinet. Small areas are not necessarily safe.
- Unplug the ice machine before cleaning behind the kickplate or making repairs.
- Setting power switch to OFF only removes power from the refrigeration system, it does not remove power from other circuits. To fully power-down the machine it must be unplugged.

NOTE: WE STRONGLY RECOMMEND THAT ANY SERVICING BE PERFORMED BY A QUALIFIED INDIVIDUAL.

WARNING: PROPER INSTALLATION REQUIRES CONNECTION TO THE WATER SUPPLY, A DRAIN AND A DEDICATED ELECTRICAL CIRCUIT. THESE CONNECTIONS ARE THE RESPONSIBILITIES OF THE INSTALLER. IMPROPER CONNECTIONS CAN RESULT IN PERSONAL INJURY, PROPERTY DAMAGE AND IMPROPER OPERATION. THE ICE MACHINE MUST BE INSTALLED ACCORDING TO ALL APPLICABLE NATIONAL, STATE AND LOCAL CODES AND REGULATIONS.

PROPER DISPOSAL OF THE OLD ICE MACHINE

Child entrapment and suffocation are not problems of the past. Junked or abandoned ice machines are still dangerous, even if they will sit for “just a few days.” If you are getting rid of your old ice machine, please follow the instructions below to help prevent accidents.

BEFORE YOU THROW AWAY YOUR OLD ICE MACHINE, TAKE OFF THE DOORS.



CFC DISPOSAL

Your old ice machine may have a cooling system that used CFCs (chlorofluorocarbons). CFCs are believed to harm stratospheric ozone. If you are throwing away your old ice machines, make sure the CFC refrigerant is removed for proper disposal by a qualified service. If you intentionally release this CFC refrigerant you can be subject to fines and imprisonment under provisions of the environment legislation.

WARNING & SAFETY LABELS



CAUTION:
Located on the back of the unit.

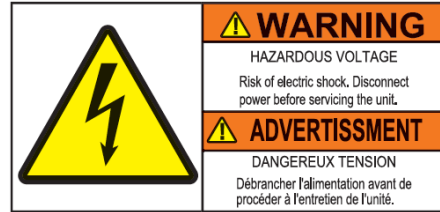

WARNING:
Located on the back of the unit.

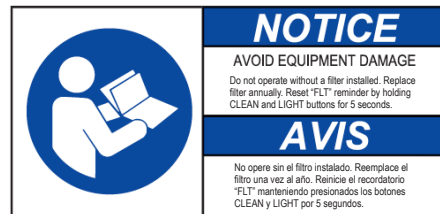

NOTICE:
Behind front door next to water filter.

UNCRATING

Required Tools:

- Cutting utensil (utility knife)
- Hammer
- Crowbar
- Phillips screwdriver

INSPECT FOR CONCEALED DAMAGE. AGAIN, IMMEDIATELY FILE A CLAIM WITH THE FREIGHT CARRIER IF THERE IS DAMAGE.

The following procedure is recommended for uncrating the unit:

Move your unit as close to the final location as possible before removing the wooden skid.

- Remove staples securing cardboard box to the wooden skid. Then discard any outer packaging (cardboard, clear plastic). Cut off all strapping.
- IMPORTANT:** Remove Styrofoam block before removing ice machine from pallet.
- Remove skid by carefully lifting the ice machine off and place skid aside.
- Open the unit and remove any packing material. Styrofoam, tape, and any other material used for shipping purposes.
- Remove kickplate located inside ice bin. The kickplate attaches to the front of the ice machine with magnets.

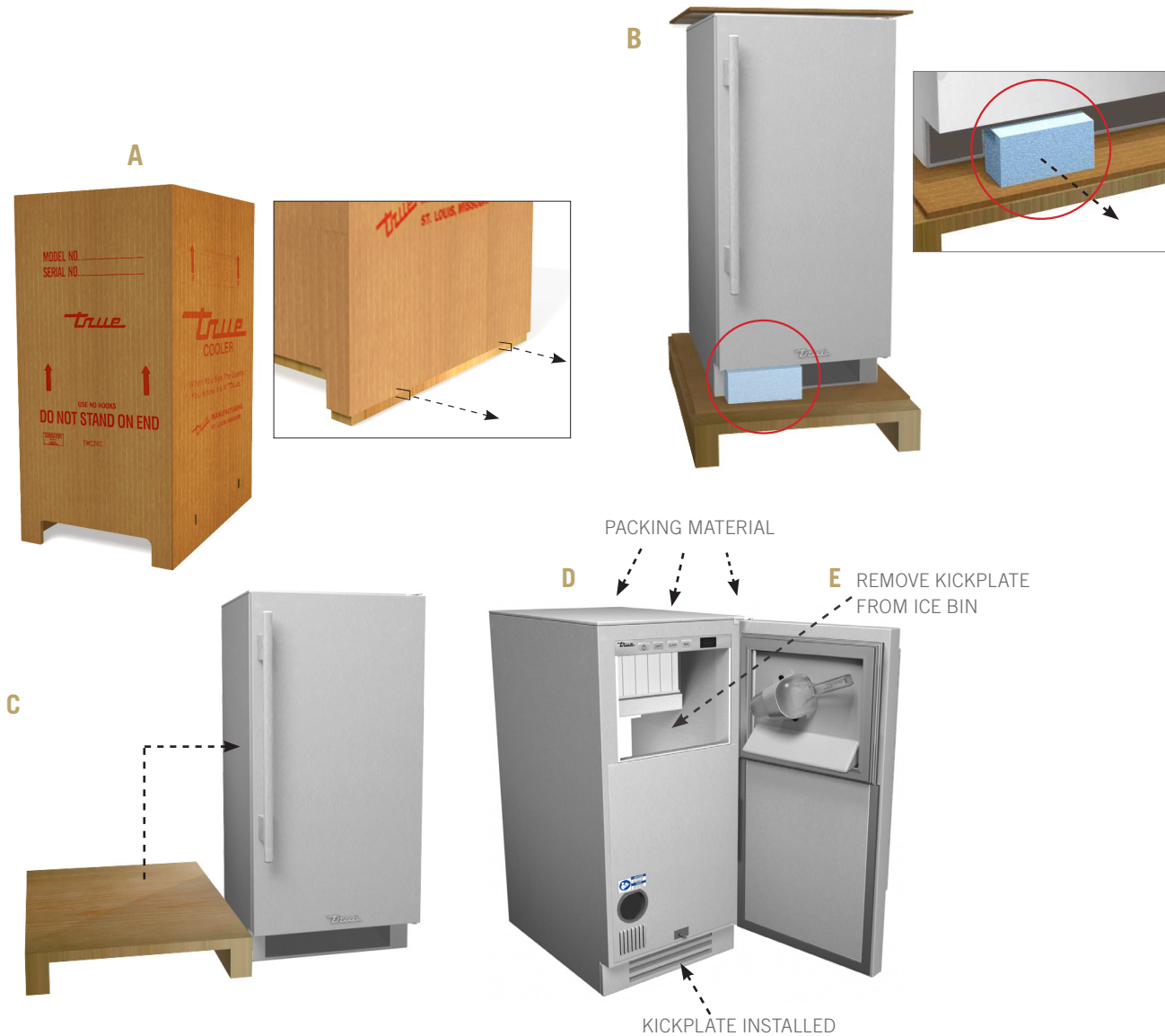

ELECTRICAL SPECIFICATIONS

WARNING: THIS APPLIANCE MUST BE PROPERLY GROUNDED. DO NOT, UNDER ANY CIRCUMSTANCES, CUT OR REMOVE THE THIRD (GROUND) PRONG FROM THE POWER CORD. FOR PERSONAL SAFETY, THIS APPLIANCE MUST BE PROPERLY GROUNDED.

The electrical outlet must be within three feet of the center of the back wall of the ice maker's final location. Outlet must be flush with wall and comply with local electrical codes.

Before your new unit is connected to a power supply, check the incoming voltage with a volt meter. If anything less than 100% of the rated voltage for operation is noted, correct immediately.

The power cord of this appliance is equipped with a three-prong (grounding) plug which mates with a standard three-prong (grounding) wall outlet to minimize the possibility of electric shock hazard from this appliance. A 115V AC, 60 Hz, 15 amp circuit breaker and electrical supply are required.

Each unit requires a dedicated circuit. Have the wall outlet and circuit checked by a qualified electrician to make sure the outlet is properly grounded.

OUTDOOR USE

All True undercounter ice machines are UL-rated for outdoor use.

When installing outdoors, keep in mind that certain regions may experience colder ambient temperatures than others. When this decrease in temperature occurs, the unit may stop producing ice before it is full and begin showing FUL on the display. This is caused because the internal thermostat has reached the cut off temperature. Furthermore, these stainless steel cabinets are very heavily insulated and will retain the cold temperature for long periods of time.

The location of the unit will also play a factor in the false full reading. If the unit is built into a kitchenette

If the outlet is a standard two-prong outlet, it is your personal responsibility and obligation to have it replaced with the properly grounded three-prong wall outlet.



Do not use an extension cord or two-prong adaptor. Electrical ground is required on this appliance.



The unit should always be plugged into its own individual electrical circuit which has a voltage rating that matches the rating plate. This provides the best performance and also prevents overloading house wiring circuits which could cause a fire hazard from overheated wires. Never unplug your ice machine by pulling on the power cord. Always grip plug firmly and pull straight out from the outlet.

Repair or replace immediately all power cords that have become frayed or otherwise damaged. Do not use a cord that shows cracks or abrasion damage along its length or at either end. When moving the ice machine away from the wall, be careful not to roll over or damage the power cord.

The unit is approved by UL for outdoor installation.

area, within stone, brick, or wood etc., this will further delay the reaction time. Basically, even if your temperatures increase during the day, your cabinet may be holding the colder temperature from the evening before.

If your unit is showing a false full reading, rub your hand on the inside ice level bar.

Once it senses the warm temperature it will start ice production again. It is recommended during colder periods to increase the ice level using the adjustment screw. It is located behind the louver grill on the front of the cabinet. The level can be increased by turning the screw clockwise.

NOTES



INSTALLATION SPECIFICATIONS

INSTALLATION SPECIFICATIONS FOR SOLID PANEL AND INTEGRATED PANEL (OP)

INSTALLING DOOR STOP

PLUMBING CONNECTIONS

LEVELING ICE MACHINE

WATER SUPPLY

DRAIN CONNECTION

WATER FILTER

PUMPING HEIGHTS

DRAIN ALARM (DRN)



15 INCH STAINLESS STEEL



ICE MACHINE TUI-15-R/L-SS-B

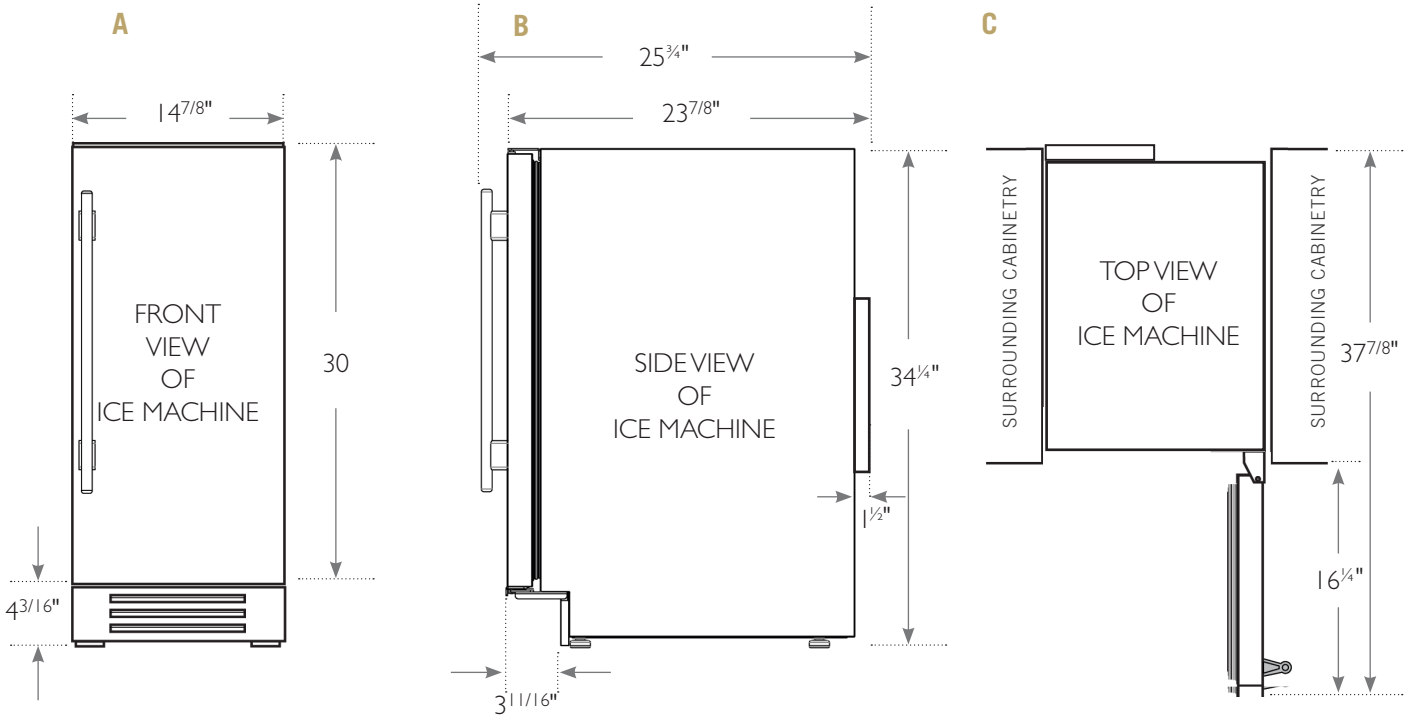

Dimensions may vary by $\pm 1/8"$

INSTALLATION SPECIFICATIONS - (ALL TUI-15 INCH UNDERCOUNTER MODELS)

True's Stainless Solid Door units are designed to be inserted into a cabinet opening or free standing. Below are recommended minimum dimensions for rough opening.

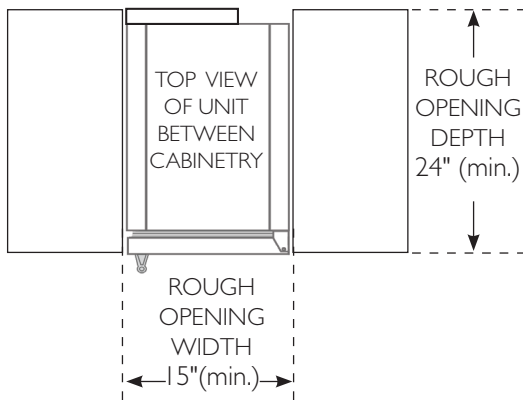

Avoid running wires or plumbing in this area.

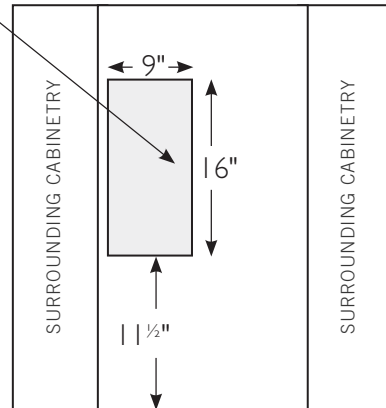

FRONT VIEW OF CABINETRY OPENING

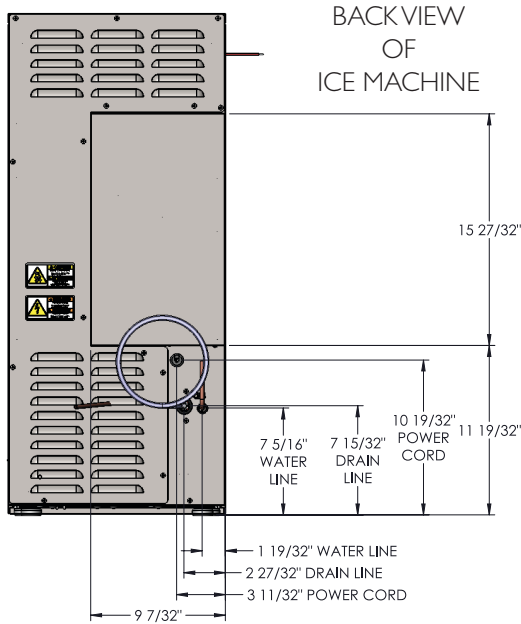

CAUTION: DO NOT ALLOW THE ICE MACHINE TO BE EXPOSED TO TEMPERATURES BELOW 32°F (0°C) AS THIS WILL CAUSE ANY WATER IN THE MACHINE TO FREEZE. FAILURES CAUSED BY EXPOSURE TO FREEZING TEMPERATURES ARE NOT COVERED BY THE WARRANTY.

ALLOWABLE TEMPERATURES AND PRESSURES

	MINIMUM		MAXIMUM	
AIR TEMPERATURE	40° F	4° C	100° F	38° C
WATER TEMPERATURE	40° F	4° C	100° F	38° C
WATER PRESSURE	20 PSI	1.4 BAR	80 PSI	5.5 BAR

* Max Ice Production	70 lbs/day
** Rated Ice Production	57 lbs/day

* Performance Rated at 70°F air / 50°F water / 30 psig water pressure.
 ** Performance Rated at 90°F air / 70°F water / 30 psig water pressure.



15 INCH OVERLAY PANEL



ICE MACHINE TUI-15-R/L-OP-B

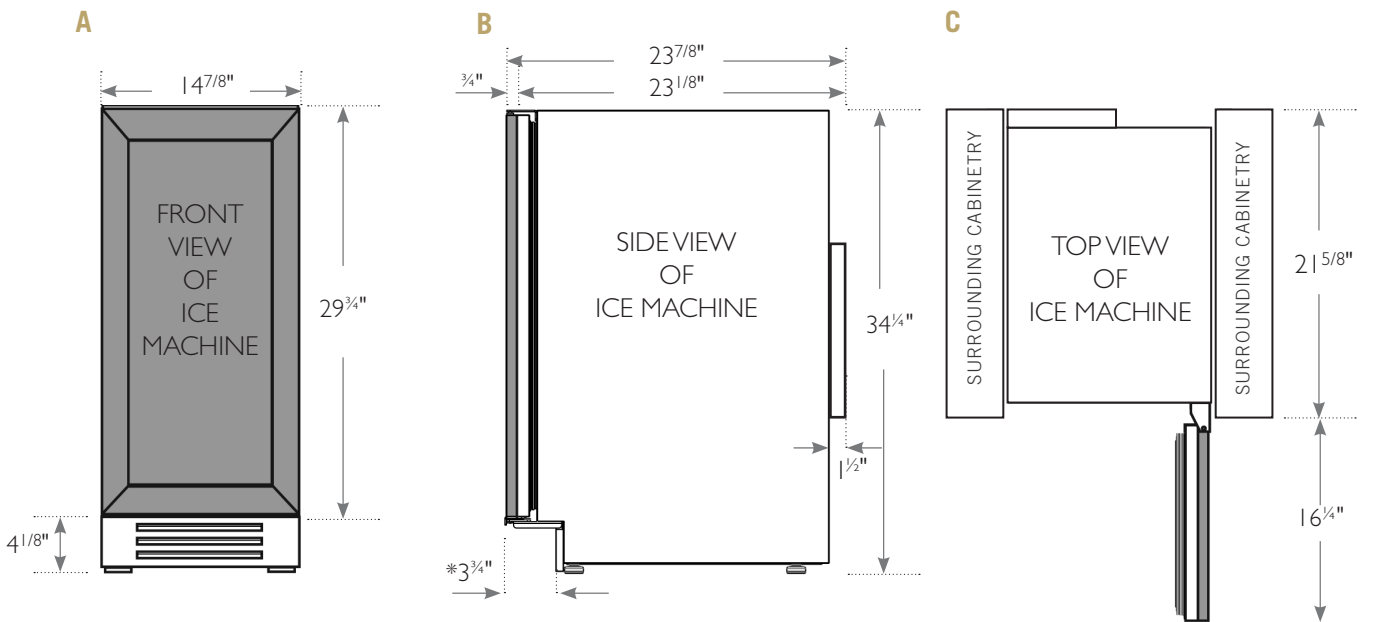

Dimensions may vary by $\pm 1/8"$
 *Including 3/4" thick panel (provided by others)

NOTE: UNIT IS SHOWN WITH OPTIONAL PANEL / HANDLE PROVIDED BY OTHERS.

CUSTOM PANEL INSTALLATION

Overlay units can be fitted with custom panels to match adjacent cabinetry. Two specification options for panels sizes are given in these instructions for overlay units: Standard overlays and Integrated Panels. The standard overlay panel dimensions fully cover the provided appliance door. The integrated panel options extend above the door and conceal the hinge assembly to match full overlay cabinet doors. See pictures below for reference.

STANDARD OVERLAY PANEL



INTEGRATED OVERLAY PANEL



CUSTOM PANEL INSTALLATION - SOLID PANEL PANEL

STANDARD OVERLAY PANEL

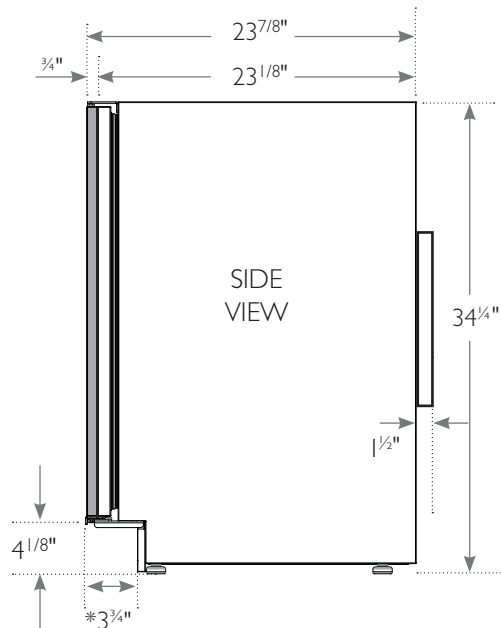
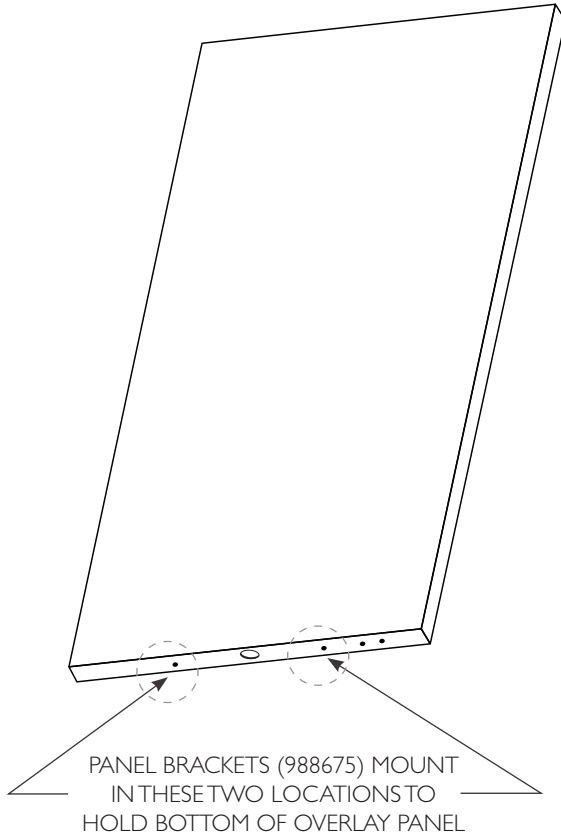

SOLID DOOR PANEL DIMENSIONS

Door Panel Width	14 5/8"
Door Panel Height	29 23/32"
Door Panel Depth	3/4" max
Door Panel Weight	10 lb. max.

*Including 3/4" thick panel (provided by others)

CUSTOM PANEL INSTALLATION

STANDARD OVERLAY PANEL

SOLID DOOR	15 INCH
DOOR PANEL WIDTH	14 ⁵ / ₈ "
DOOR PANEL HEIGHT	29 ²³ / ₃₂ "
DOOR PANEL DEPTH	3/4" max
DOOR PANEL WEIGHT	20 lb. max
RAIL STYLE DIMENSION	2" min

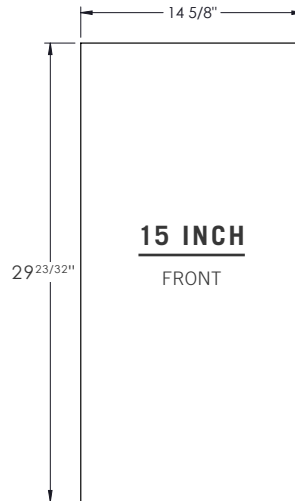

INTEGRATED OVERLAY PANEL

SOLID DOOR	15 INCH
DOOR PANEL WIDTH	14 ⁵ / ₈ "
DOOR PANEL HEIGHT	30 ¹ / ₈ "
DOOR PANEL DEPTH	3/4" max
DOOR PANEL WEIGHT	20 lb. max
RAIL STYLE DIMENSION	2" min

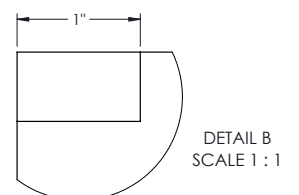
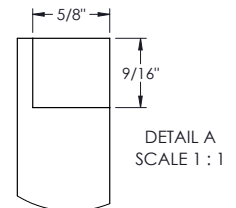
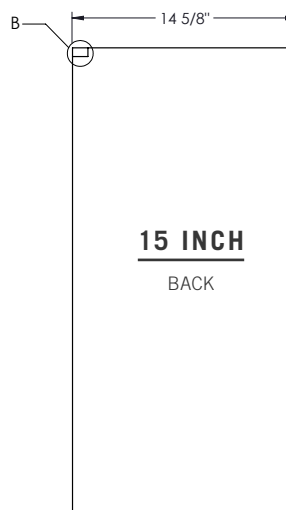
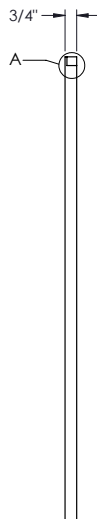
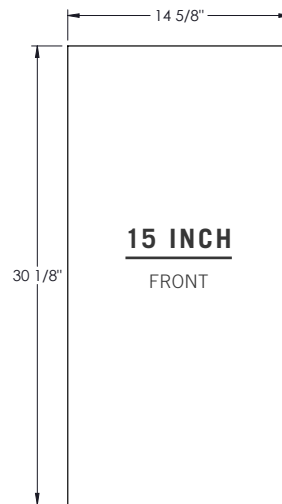

CUSTOM PANEL INSTALLATION

Required Tools:

- Phillips Screwdriver
- 3/8" Wrench
- 1/8" Drill Bit
- Three (3) Screws #6

SEE PAGE 16 FOR OVERLAY PANEL DIMENSIONS BEFORE INSTALLING.

FOR EASY OVERLAY INSTALLATION, ICE MACHINE DOOR REMOVAL IS REQUIRED.

1. Open front door and pull kickplate forward to remove.
2. To remove door, back out two bottom hinge screws with a 3/8" wrench. Secure door while removing screws. Remove two Phillips screws from the top hinge. Save all these screws for later reinstall.
3. Lay door on a safe solid surface. Lay cardboard or other safe material down before working on the door.
4. Remove door gasket from the inside of the door frame. Place gasket to the side for later reinstall.
5. There are pre-marked areas on the front of the door. Drill these pre-marked holes with 1/8" drill bit. Make sure to drill all the way through the door.

NOTE: IF HANDLE IS BEING USED ON OVERLAY, INSTALL IT BEFORE STEP 8 (SEE IMAGE A ON PAGE 22). FOR BEST INSTALLATION, SCREWS ATTACHING HANDLE SHOULD BE RECESSED.

6. It is recommended to clamp the door front on top of the overlay before drilling pilot holes and installing anchor screws. The clamp ensures the overlay panel and door stay aligned with each other while installing. Once panel is clamped in place, pilot holes may be drilled into the panel from the rear side of the door. Mark to only drill 1/2" into rear side of door.

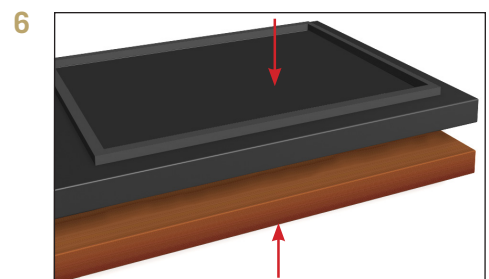
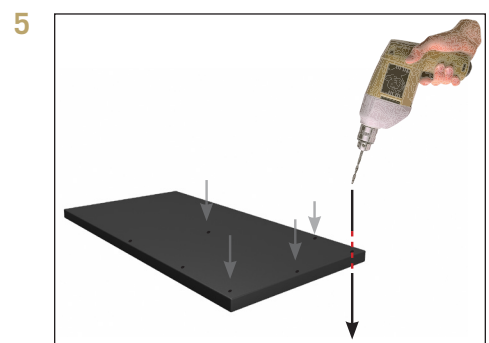
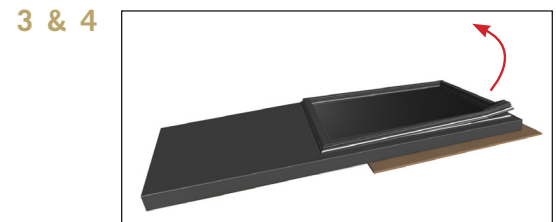

CUSTOM PANEL INSTALLATION

- Once all holes are pre-drilled, use the appropriate specified screws to secure the overlay panel onto the front of the ice machine door. Be sure to attach the bottom of the panel to the door using the brackets.
- Reinstall all components in reverse order. Door gasket snaps back into place. Overlay panel and door stay aligned with each other while installing.

IMAGE A

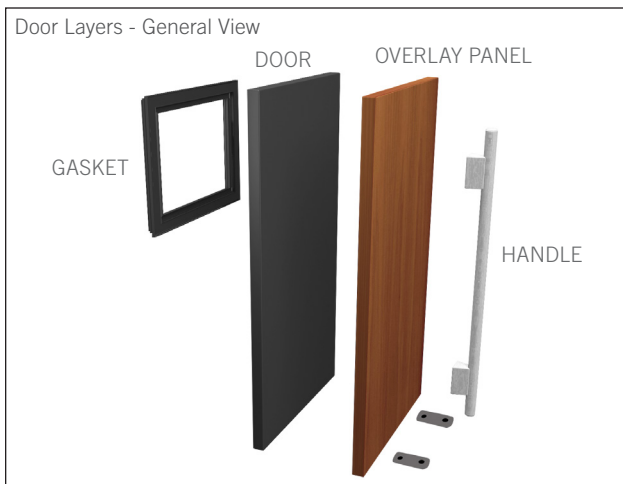
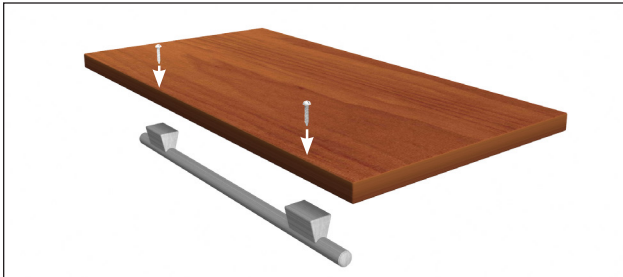

OVERLAY PANEL

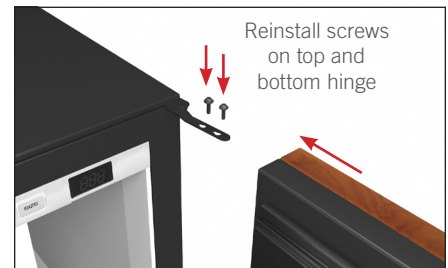
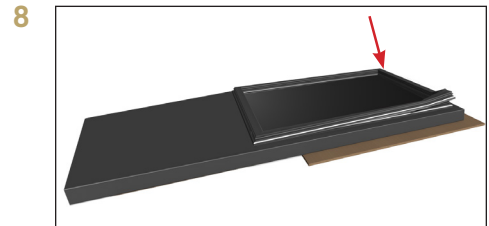
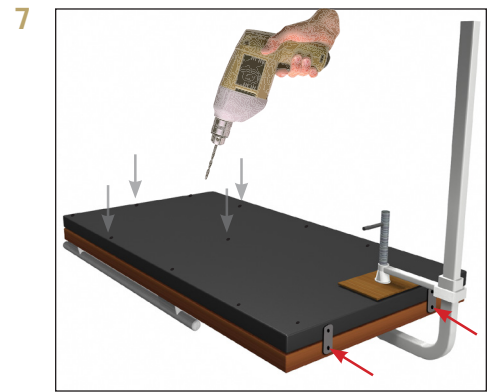

INSTALLING THE DOOR STOP

All units are provided with an optional door stop. When installed, the door stop will restrict the door from opening past approximately 120° to prevent damage to surrounding cabinetry. To install the door stop, use the two screws provided and secure the bracket to the bottom of the door on the same side as the hinge.

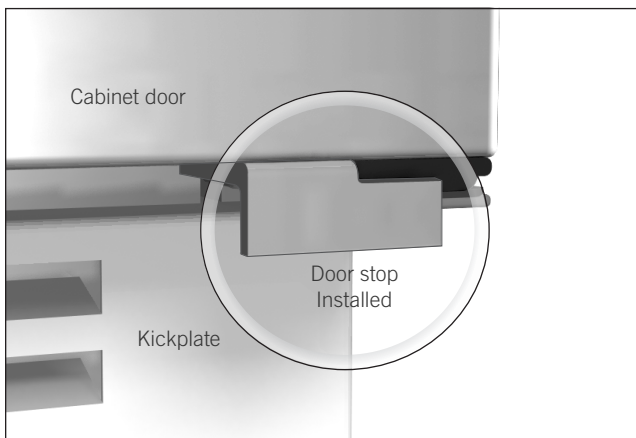
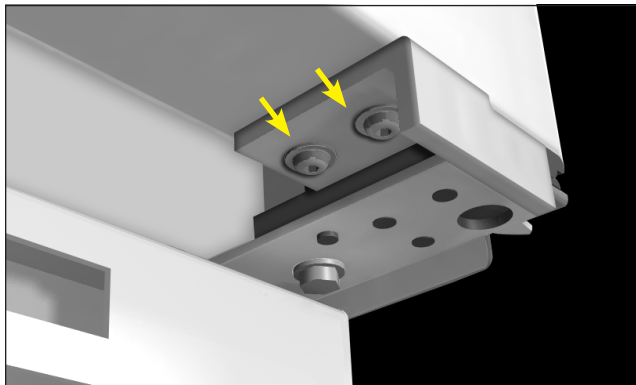
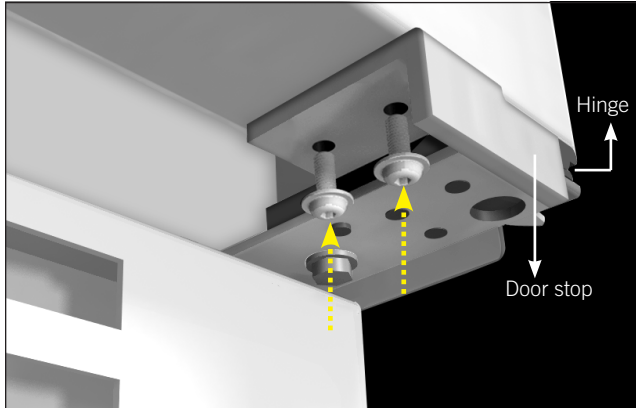

PLUMBING CONNECTIONS

The ice machine must be installed with adequate clearance for water and drain connections at the rear of the unit. Prepare the water supply line and drain connections before installing your ice machine.



LEVELING ICE MACHINE

1. Set unit in its final location. Be sure there is adequate ventilation in your room.
2. Proper leveling of your True unit is critical to operating success. Effective drainage and door operation will be affected by leveling. Adjust leg levelers on the front and back of the cabinet if needed to level the unit.

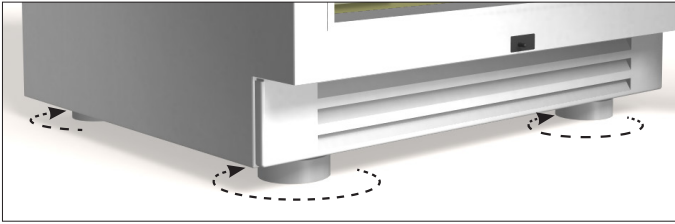

3. The unit should be leveled from the top of the unit front to back and side to side with a level. If the ice machine is not level adjust the stainless steel leg levelers. The leg levelers can be adjusted by turning to reach the desired leveling height as shown in the illustration above.

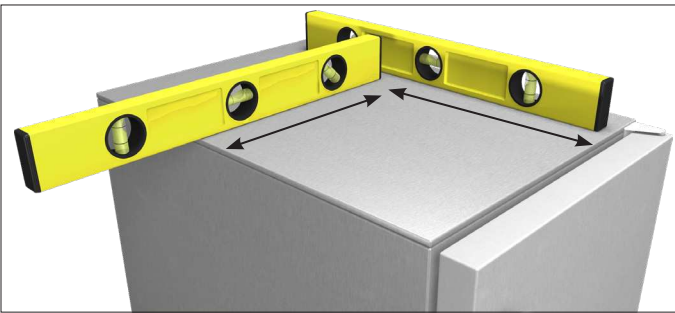

4. Free plug and cord from back of ice machine (do not plug in).
5. The unit should be placed close enough to the electrical supply so that extension cords are never used.
6. Once installed in final location, attach kickplate to the magnets on the front of the unit.

WARNING: COMPRESSOR WARRANTIES ARE VOID IF THE UNIT IS MORE THAN SEVEN FEET (2.1 M) FROM PLUG-IN CONNECTION OR IF AN EXTENSION CORD IS USED.



WATER SUPPLY

Locate the water supply.

The water supply line should be connected to the house supply with an easily accessible shut-off valve between the water supply and the ice machine. A reverse osmosis system can be used, provided there is constant water pressure of 20 psi (1.4 bar) to 80 psi (5.5 bar) supplied to the ice machine at all times. A copper line is not recommended for this application.

CAUTION: WATER PRESSURE MUST BE BETWEEN 20 PSI (1.4 BAR) AND 80 PSI (5.5 BAR). A REVERSE OSMOSIS SYSTEM CAN BE USED, PROVIDED THE WATER PRESSURE STAYS WITHIN THE REQUIRED RANGE ABOVE. IF THE WATER PRESSURE EXCEEDS THE MAXIMUM PRESSURE, INSTALL A WATER PRESSURE REGULATOR.

A cold water supply line must be supplied to the ice machine. Use 1/4" OD copper, braided stainless steel or PEX tubing and compression fittings (not included). The incoming water temperature must remain between 40°F (4°C) and 100°F (38°C).

Do not connect the ice machine to a hot water supply. Be sure all hot water restrictors installed for other equipment are working, such as check valves on sink faucets, dishwashers, etc.

Insulate the water supply line to prevent condensation.

ELECTRICAL & PLUMBING

ELECTRICAL	PLUMBING
Voltage: 115/60/1	Water Supply: 1/4 inch OD copper, braided stainless steel or PEX tubing and compression fittings (not included) Drain Pump Connection: Supplied with 8 ft. of 3/8 inch OD plastic tubing
Min Circuit Ampacity (amps): 15	
Power Cord Length: 8'	
Annual kWh Consumption: 9.5 kwh/100 lb	



115/60/1
NEMA-5-15R



Lumina.

DRAIN CONNECTION

CAUTION: NO MATTER WHAT DRAIN OPTION IS USED WE SUGGEST THOROUGHLY INSPECTING ALL CONNECTIONS AFTER INSTALLED TO ASSURE THERE ARE NO LEAKS.

The True Ice® machine has a built-in drain pump that will pump water up to a drain point, such as a sink.

- Eight feet of 3/8" O.D. plastic tubing is supplied with the ice machine.
- The drain pump has a maximum rise of 8 feet (2.4 m) and a maximum run of 100 feet (33 m).
If higher than 8 feet, an optional pump may be required.
- The floor drain must be large enough to accommodate drainage from all drain lines.
- The drain pump discharge line must terminate at an open site drain.

OTHER DRAIN CONNECTIONS

To accommodate your installation we have also provided a few pieces which allow for different drain configurations:

Fitting 1 - 3/8" to 3/8" union adapter



CAUTION: FOR CONNECTION TO WORK AS DESIGNED, TUBING SHOULD BE CUT AT PERFECT 90° DEGREE ANGLE BEFORE INSTALLING ON UNION ADAPTER.

Fitting 2 - 3/8" O.D. to 1/2" ID barb fitting.



OPTION 1

Extending current 3/8" O.D. drain line.

- To do this install, use provided 3/8" O.D. union adapter.

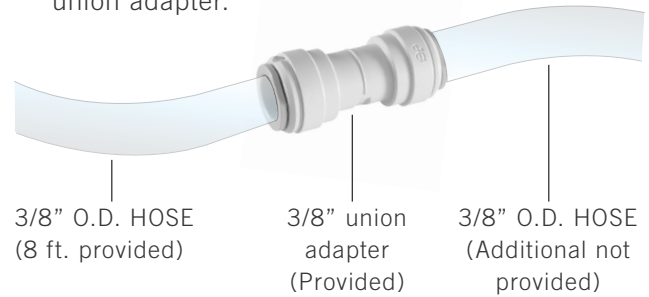

CAUTION: THIS MUST NOT BE EXTENDED MORE THAN 100 FOOT RUN OR HIGHER THAN AN 8 FOOT RISE.

OPTION 2

Adapting provided 8 foot 3/8" O.D. drain line to 1/2" I.D. / 5/8" O.D. drain line.

- To do this connect 3/8" union adapter to current drain line. (Make sure drain line is cut at perfect 90° degree angle before installing union adapter).
- Push smooth end of barb fitting into the 3/8" O.D. union adapter & then connect 1/2" I.D. / 5/8" O.D. to barbed end of plastic fitting securely.

NOTE: 1/2" I.D. / 5/8" O.D. TUBING NOT PROVIDED.

CAUTION: IF THIS OPTION IS CHOSEN, THE MAXIMUM PUMP RISE IS 4 FOOT.

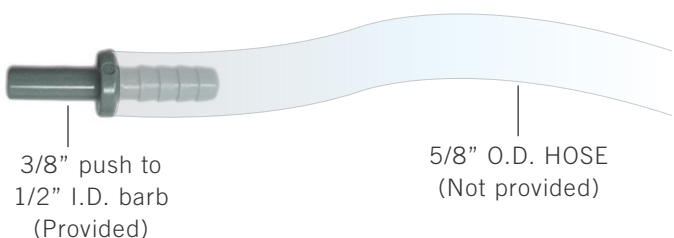

WATER FILTER

The built-in water filter is designed to filter sediment, remove unpleasant taste and odor and inhibit scale. The life expectancy of the filter is twelve months for low scale water and six months if the water has a high level of scale. The ice machine monitors how long the filter has been in operation and will display “FLT” when the filter needs to be replaced. See water filter replacement instructions on page 37.

Replacement water filters are available through your True dealer or online store at www.true-residential.com.

CAUTION: INSTALL THE WATER FILTER BEFORE TURNING ON THE WATER SUPPLY TO THE ICE MACHINE.

CAUTION: DO NOT ALLOW THE ICE MACHINE TO BE EXPOSED TO TEMPERATURES BELOW 32°F (0°C) AS THIS WILL CAUSE ANY WATER IN THE MACHINE TO FREEZE. FAILURES CAUSED BY EXPOSURE TO FREEZING TEMPERATURES ARE NOT COVERED BY THE WARRANTY.

POSITION THE UNIT

Once the unit has been leveled and connected to a drain, the water supply can be connected and turned on. The unit can then be plugged in and energized.

Once these steps are complete, slide the unit into its final desired position, presumably inside the cabinetry. You should then proceed to the “BEFORE OPERATING” step on page 30.

PUMPING HEIGHTS

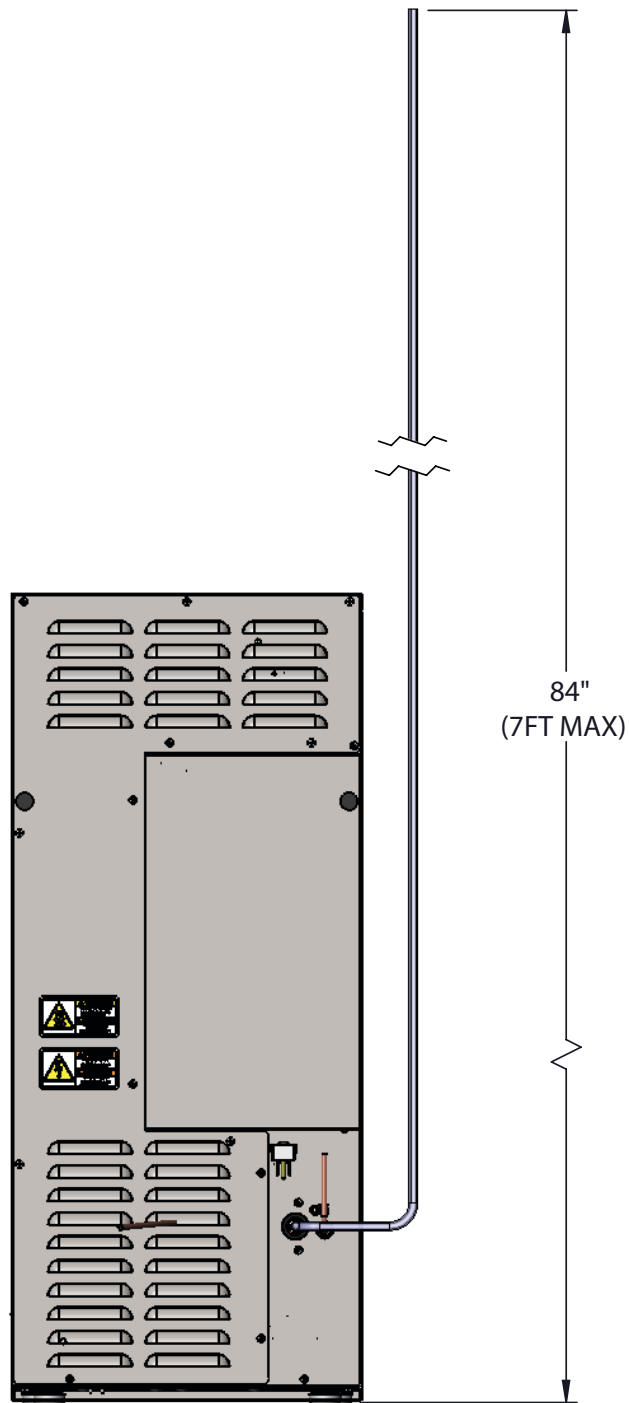

STANDARD PUMP
WITH 3/8" O.D. HOSE

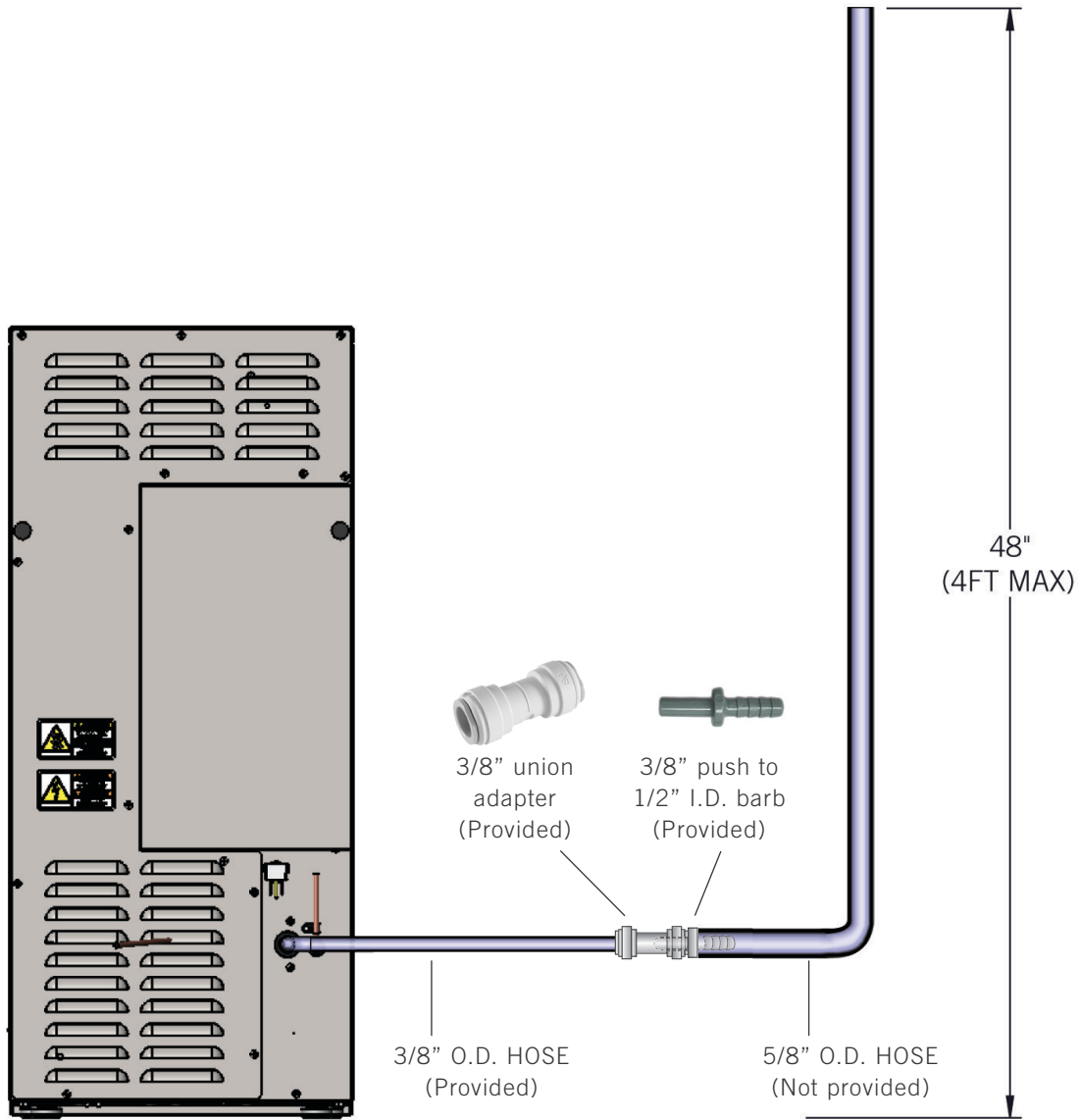

STANDARD PUMP WITH
3/8" O.D. HOSE TO 5/8" O.D. HOSE

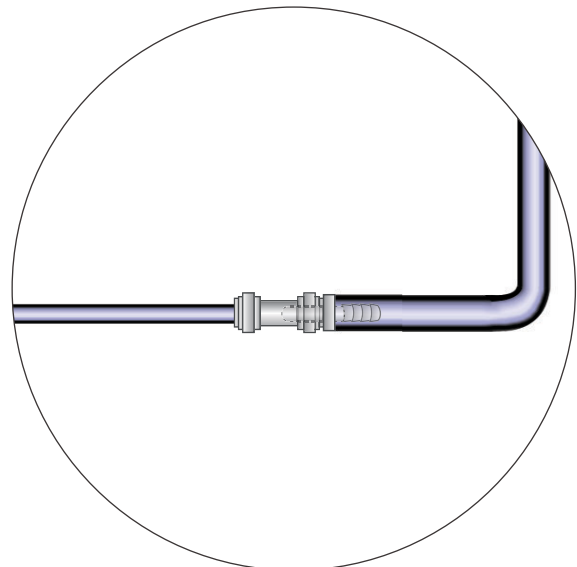

DRAIN ALARM (DRN)

- The control will automatically signal and shut off the water supply in the event of a drain failure.
- If a clogged drain clears the display will read “DRN-OFF”.

CAUTION: ADHERE TO LOCAL AND STATE PLUMBING CODES.

DO NOT EXCEED THE MAXIMUM PLUMBING HEIGHTS FOR THE GIVEN SETUP. THE DRAIN ALARM IS INITIATED BY THE CONTROL BOARD IN THE EVENT OF IMPROPER DRAINAGE.

VERIFY THE ICE MAKER DRAINS THROUGH TWO CYCLES WITHOUT ANY ALARM DURING INSTALLATION.



TRUE PRECISION CONTROL® OPERATION AND
TRUE ICE® MACHINE COMPONENTS

BEFORE OPERATING

POWER AND BIN LIGHT

ICE MAKING SEQUENCE AND CUBE SIZE ADJUSTMENT

BIN THERMOSTAT / ICE LEVEL ADJUSTMENTS



BREAKER RESET

WATER QUALITY SETTING

TRUE PRECISION CONTROL® OPERATION

1. Power Button
2. Bin Light
3. Initiate Cleaning Sequence
4. Adjust Cube Size
5. Display















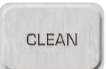

KEY COMBINATIONS	LCD READOUTS	DESCRIPTION
 Off / On (hold 3 sec)		Power unit off / on.
Making Ice		Circulation pump is running, spraying water into the molds to make cubes.
Harvesting Ice		Water will fill for the next batch of ice and drop the ice in the molds.
Fill		Water is filling the reservoir and will run for 2-3 minutes.
Bin is Full		Ice has reached the bar located on the interior right hand wall.
 Replace Water Filter (hold 3 sec)		Unit will shut down. Change water filter, clean, and sanitize machine.
 Color		Switch LED colors - Slowly press and release to switch between 14 colors.
 Cube Size Setting		Factory default cube size is “2” the size can be changed from 1 to 5. 1 being the smallest and 5 being fuller interior cube.

TRUE PRECISION CONTROL® OPERATION

1. Power Button
2. Bin Light
3. Initiate Cleaning Sequence
4. Adjust Cube Size
5. Display



KEY COMBINATIONS	LCD READOUTS	DESCRIPTION
 Clean Mode (hold 3 sec)		Press and hold “CLn” for 3 seconds. Unit will count down from 30 to “off”.
 Add Cleaning Chemicals		In the clean mode. “Add” notification will give you 45 seconds to add the cleaners.
 +  Low-scale Water (hold 3 sec)		Average water quality setting. Low scale is factory setting. Normal operation. Filter change reminder set at 1 year.
 +  High-scale Water (hold 3 sec)		Below average water quality setting. Adds time to harvest. Filter change reminder set at 6 months.
Drain Pump Failure		Clogged or kinked drain line. Drain was not able to clear within 5 minutes of running.
Thermistor 1 Failure		Thermistor 1 is located in condenser discharge air. Probe is open or has a loose connection at control board.
Thermistor 2 Failure		Thermistor 2 is located on the suction line by the evaporator coil. Probe is open or has a loose connection at control board.
Ambient too Hot		Condenser discharge thermistor reached 155°F.
System too Hot		Suction line evaporator thermistor reached 125°F



TRUE PRECISION CONTROL® OPERATION

1. Power Button
2. Bin Light
3. Initiate Cleaning Sequence
4. Adjust Cube Size
5. Display



KEY COMBINATIONS	LCD READOUTS	DESCRIPTION
Ambient too Cold		Condenser discharge thermistor reached 50°F.
System too Cold		Suction line evaporator thermistor reached 5 degrees within the first 10 minutes of "ice" mode.

BEFORE OPERATING

To insure ice quality, please clean and sanitize this machine prior to first use. To ensure proper operation, follow the installation checklist at the front of this manual.

NOTE: COSTS ASSOCIATED WITH ADJUSTMENTS, CLEANING AND SANITIZING PROCEDURES IN THIS GUIDE ARE NOT COVERED BY THE WARRANTY.

WARNING: DO NOT USE THE ICE MACHINE TO STORE ANYTHING OTHER THAN ICE.

WARNING: DO NOT OPERATE EQUIPMENT THAT HAS BEEN MISUSED, NEGLECTED, DAMAGED, ALTERED OR MODIFIED IN ANY WAY.

ICE MAKING SEQUENCE

Your True Ice® machine will produce one batch of ice (24 cubes) roughly every 30 minutes. The following steps occur during ice making:

HARVEST / FILL – The ice machine always begins in the harvest mode. Display will read “HAr.” During harvest all the ice cubes are melted free from the evaporator. The ice machine does this by warming up the evaporator with warm refrigerant. During harvest the ice machine will also fill with water and drain off any excess/residual ice making water. At start up the harvest will last two minutes.

ICE MAKING – During ice making the display will read “ICE.” Water is sprayed into the inverted ice cups while the evaporator is cooled. This causes ultra-clear ice cubes to form inside each ice cup. The compressor, condenser fan and water pump all operate during this mode. The ice machine automatically adjusts the freeze time based on the ambient air temperature.



FULL BIN – The ice machine shuts off automatically when the bin is full of ice. A full bin is detected when ice touches the bin thermostat tube. The machine will come back on when ice is no longer in contact with the thermostat tube.

POWER

- Press the power button once to begin ice making operation. Press the button a second time to turn the ice machine off.
- When unit is plugged in, the control board goes through a sequence of checks to verify all sensors are working properly.
- The drain system is energized when power is supplied to the unit. It automatically turns on when it senses water in the drain tube.
- Display will show “OFF” until the power button is pressed.
- If the unit powers the drain pump but the drain remains clogged for five minutes, the display will show “drn” and cut power to the unit.
- If unit is too cold (below 50°F), too hot, or if the temperature probe is unplugged or has failed, the unit shuts down and displays an error message.

BIN LIGHT

Use the  button as follows:

- PRESS THE  BUTTON REPEATEDLY TO CYCLE THROUGH THE 14 PRESET DESIGNER COLORS.
- HOLD THE  BUTTON FOR FIVE SECONDS TO TOGGLE THE BIN LIGHT ON OR OFF.

CUBE SIZE ADJUSTMENT

Pressing the  button repeatedly allows you to toggle between the available cubes sizes.

There are five cube sizes possible, where

“1” = smallest, “5” = largest.

NOTE: CUBE SIZE VARIATION IS RELATIVELY SMALL. WHEN SET TO “1”, THE CUBES WILL BE HOLLOW, LIKE A THIMBLE OR SHOT GLASS. WHEN SET TO “5”, THE CUBES WILL BE SOLID. ALWAYS LET THE MACHINE MAKE TWO BATCHES OF ICE BEFORE RESETTING THE THICKNESS.

BIN THERMOSTAT / ICE LEVEL ADJUSTMENT

The bin thermostat senses when ice has reached the top of the bin and shuts the machine off. The thermostat is adjusted at the factory for room-temperature operation and normally will not require adjustment.

To check the operation of the bin thermostat, hold three ice cubes in contact with the thermostat tube in the bin. The machine should stop making ice within five minutes. Display will read "FUL". Then remove the ice cubes. The machine should then restart within five minutes.

If necessary, the level of ice in the bin can be adjusted by turning the bin thermostat screw. This screw is located just behind the kickplate on the left side of the machine. Turn the screw clockwise to raise the ice level, counter-clockwise to lower the ice level.

Bin thermostat / Ice level adjustment is located behind front kickplate. Remove front kickplate.

Use a standard screwdriver:

RAISE ICE LEVEL - Turn adjustment clockwise to raise ice level.

LOWER ICE LEVEL - Turn adjustment counter-clockwise to lower ice level.

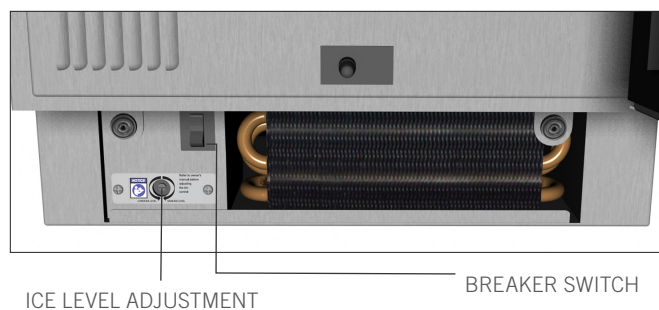

BREAKER RESET

The breaker switch is located behind the kickplate. If the unit trips, flip the switch down. To reset, flip the switch up.

WATER QUALITY SETTING

Your True Ice® machine may operate differently depending on the water quality setting of the machine. To determine your water quality, it is recommended to purchase a water quality test kit from a local source.

LOW SCALE ("LSC" ON THE DISPLAY):

When set to LSC, the machine will make ice more quickly, harvest more quickly and will require a filter change every 12 months.

HIGH SCALE ("HSC" ON THE DISPLAY):

When set to HSC, the machine will allow more time for freezing and harvesting ice to compensate for the presence of scale. The water filter should be replaced more frequently.

Press and hold the **CLEAN** and **SIZE** buttons simultaneously for three seconds to toggle between the LOW SCALE ("LSC") and HIGH SCALE ("HSC") water quality settings on the machine. Set unit to LSC when the total dissolved solids (TDS) are below 300 mg/L. Set unit to "HSC" when the total dissolved solids (TDS) are above 300 mg/L.

NOTES



GENERAL MAINTENANCE

WATER SHUTTERS, ICE GUIDE, AND PUMP CLEAN-OUT CAP SPRAY
BAR DISASSEMBLY

WATER FILTER REPLACEMENT AND REPLACEMENT PARTS

CONDENSER CLEANING

STAINLESS STEEL CLEANING INSTRUCTIONS

DESCALING AND SANITIZING

WINTERIZING INSTRUCTIONS AND RESTART

FREQUENTLY ASKED QUESTIONS

WARRANTY

GENERAL MAINTENANCE

You are responsible for maintaining the ice machine in accordance with the instructions in this manual. Maintenance procedures are not covered by the warranty.

WARNING: IF YOU DO NOT UNDERSTAND THE PROCEDURES OR SAFETY PRECAUTIONS THAT MUST BE FOLLOWED, CALL YOUR LOCAL TRUE SERVICE REPRESENTATIVE TO PERFORM THE MAINTENANCE PROCEDURES FOR YOU.

True recommends that you perform the following maintenance procedures a minimum of once every six months to ensure reliable, trouble-free operation.

1. **EXTERIOR CLEANING:**
Perform as needed. Follow the stainless steel cleaning instructions listed on page 38 to insure your machine always looks like new.
2. **DESCALING AND SANITIZING:**
Perform every six months. Follow the instructions on pages 38-39 or the instructions on the inside of the ice machine door.
3. **WATER FILTER REPLACEMENT:**
Replace the water filter a minimum of every twelve months. More frequent replacement may be required if you have poor water quality. Follow the instructions on page 37.
4. **CONDENSER CLEANING:**
For optimum operation, clean your condenser every six months using the instructions on page 37.

Maintenance	Weekly	Semi-Annual	Annual	After Prolonged Shutdown	At Start-Up
Clean Cabinet Exterior	X			X	X
Sanitize Ice Machine		X	X	X	X
Descale Ice Machine		X	X	X	X
Clean Condenser Coil		X	X	X	
Change the Water Filter		X	X	X	
Check Ice Quality	X	X	X	X	X

WATER SHUTTERS

Water shutters prevent spraying water from escaping the evaporator compartment.

Removing water shutters for cleaning:

1. Lift shutter shaft out of recesses on either end of shaft.
2. To reinstall, insert ends of shaft into recesses above either side of evaporator compartment opening.



ICE GUIDE

The ice guide is seated over the spray nozzles and allows ice to fall into the bin. It must be firmly positioned over the spray bar, with the front edge inside the water trough. Spray nozzles must align with the slots in the ice guide or spray water will fall into the bin.

1. Grab guide and lift up to remove.
2. To reinstall ice guide, grab guide and position over water spray nozzles. Make sure front edge is inside of water trough.



PUMP CLEAN-OUT CAP

1. Remove clamp.
2. Pull down clean-out cap.
3. To reinstall, slide cap over hole underneath pump. Replace clamp.

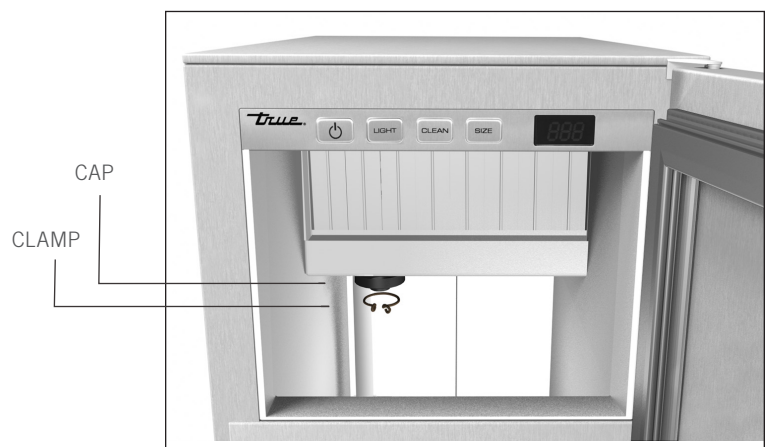

SPRAY BAR DISASSEMBLY

The spray bar is located in the water trough and supplies water to the individual ice making cups. Water from the pump sprays through the nozzles, located on the upper portion of the tubes.

Removing spray bar for cleaning:

1. Grab spray bar with one hand and the water supply hose (located below spray bar) with the other hand.
2. Carefully pull the two apart.
3. To reinstall spray bar attach the water supply hose to the bottom of the spraybar assembly. Re-seat the spray bar in the evaporator compartment.

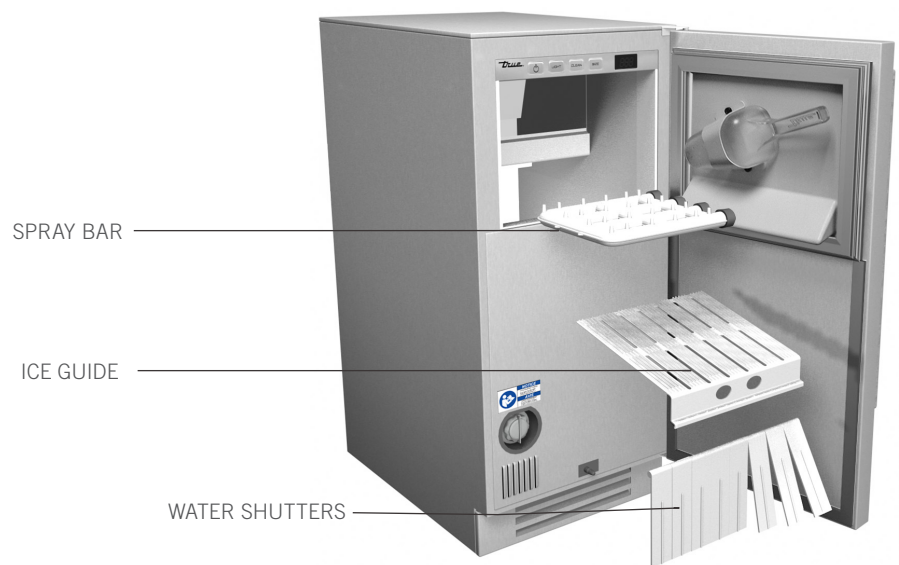
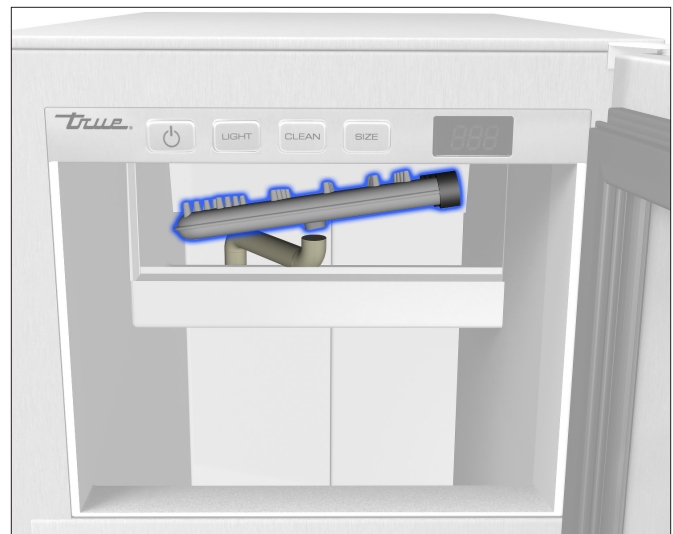
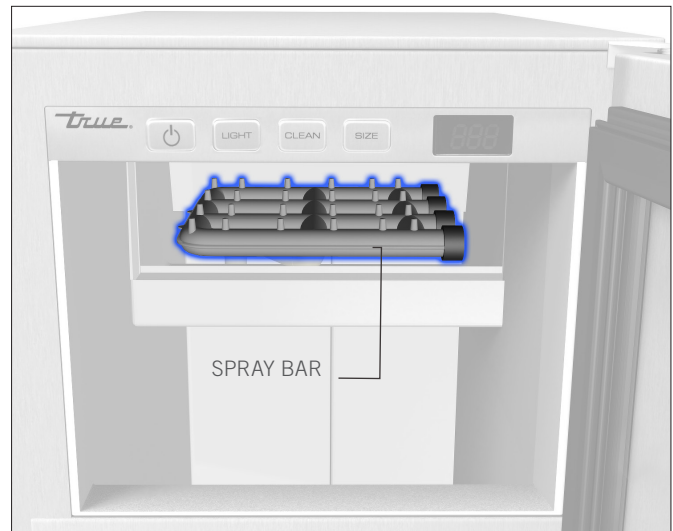

WATER FILTER REPLACEMENT

The built-in water filter is designed to filter sediment, remove unpleasant taste and odor and inhibit scale. The filter is shipped inside the ice machine and must be installed prior to running the ice machine. Install the filter by inserting it into the opening on the front of the machine and twisting it clockwise to lock it in place.

NOTE: PRIOR TO INSTALLATION OF THE FILTER, LUBRICATE THE O-RINGS OF THE FILTER.



THE ICE MACHINE WILL NOT MAKE ICE IF THE WATER FILTER IS NOT INSTALLED.

The life expectancy of the filter is twelve months for low-scale water and six months if the water has a high level of scale. The ice machine monitors how long the filter has been in operation and will display “FLT” when the filter needs to be replaced.

Replacement water filters are available through your True dealer.

CAUTION: DO NOT ALLOW THE ICE MACHINE TO BE EXPOSED TO TEMPERATURES BELOW 32°F (0°C) AS THIS WILL CAUSE ANY WATER IN THE MACHINE OR IN THE WATER FILTER TO FREEZE. FAILURES CAUSED BY EXPOSURE TO FREEZING TEMPERATURES ARE NOT COVERED BY THE WARRANTY.

REPLACEMENT PARTS

True maintains a record of the serial number for your unit. If at any time during the life of your unit, a part is needed, you may obtain that part by furnishing the model number and serial number to the company from whom you purchased your machine.

For replacement parts contact your True dealer or call True parts department at 844-849-6179.

Inquiries can be sent to:

info@true-residential.com

(636) 240-2400 • toll free (888) 616-8783

CONDENSER CLEANING INSTRUCTIONS

- Keeping the condenser coil clean will minimize required service and lower electrical cost.
- The condenser coil should be cleaned by removing dust and other build-up from the tube assembly with vacuum or a clean rag.
 1. Remove kickplate.
 2. Vacuum or use clean rag to remove dust build-up from coil.
 3. Re-install kickplate.



KICKPLATE

STAINLESS STEEL EQUIPMENT CARE AND CLEANING

CAUTION: DO NOT USE ANY STEEL WOOL, ABRASIVE OR CHLORINE BASED PRODUCTS TO CLEAN STAINLESS STEEL SURFACES.

STAINLESS STEEL OPPONENTS

There are three basic things which can break down your stainless steel's passivity layer and allow corrosion to rear its ugly head.

1. Scratches from wire brushes, scrapers, and steel pads are just a few examples of items that can be abrasive to stainless steel's surface.
2. Deposits left on your stainless steel can leave spots. You may have hard or soft water depending on what part of the country you live in. Hard water can leave spots. Hard water that is heated can leave deposits if left to sit too long. These deposits can cause the passive layer to break down and rust your stainless steel. All deposits left from food prep or service should be removed as soon as possible.
3. Chlorides are present in table salt, food, and water. Household and industrial cleaners are the worst type of chlorides to use.

STAINLESS STEEL CLEANING AND RESTORATION

Do not use stainless steel cleaners or similar solvents to clean plastic or powder-coated parts. Instead, use warm soapy water.

- For routine cleaning and removal of grease and oil, apply white vinegar, ammonia, or any good commercial detergent* with a soft cloth or sponge.
- Stainless steel polish (e.g., Zep® Stainless Steel Polish, Weiman® Stainless Steel Cleaner & Polish, Nyco® Stainless Steel Cleaner & Polish, or Ecolab® Ecoshine®) and olive oil can act as a barrier against fingerprints and smears.
- Degreasers* (e.g., Easy-Off® Specialty Kitchen Degreaser or Simple Green® Industrial Cleaner & Degreaser) are excellent for removal of grease, fatty acids, blood and burnt-on foods on all surfaces.

- For restoration/passivation or removing stubborn stains and discoloration, Brillo® Cameo®, Zud® Cleanser, Ecolab® Specifax™ First Impression® Metal Polish, Sheila Shine, or talc can be applied by rubbing in the direction of the polish lines.

**Do not use detergents or degreasers with chlorides or phosphates.*

NOTE: The use of proprietary names is intended for example only and does not constitute or imply an endorsement. Omission of proprietary cleansers from this list does not imply inadequacy.

**8 TIPS TO HELP PREVENT RUST ON STAINLESS STEEL
MAINTAIN THE CLEANLINESS OF YOUR EQUIPMENT**
Avoid build-up of hard stains by cleaning frequently. Use cleaners at the recommended strength (alkaline chlorinated or non-chloride).

USE THE CORRECT CLEANING TOOLS

Use non-abrasive tools when cleaning your stainless steel products. The stainless steel's passive layer will not be harmed by soft cloths and plastic scouring pads.

CLEAN ALONG POLISHING LINES

Polishing lines ("grain") are visible on some stainless steels. Always scrub parallel to polishing lines when visible. Use a plastic scouring pad or soft cloth when you cannot see the grain.

USE ALKALINE, ALKALINE-CHLORINATED OR NON-CHLORIDE CLEANERS

While many traditional cleaners are loaded with chlorides, the industry is providing an ever increasing choice of non-chloride cleaners. If you are not sure of your cleaner's chloride content, contact your cleaner supplier. If they tell you that your present cleaner contains chlorides, ask if they have an alternative. Avoid cleaners containing quaternary salts, as they can attack stainless steel, causing

RINSE

When using chlorinated cleaners, you must rinse and wipe dry immediately. It is better to wipe standing cleaning agents and water as soon as possible. Allow the stainless steel equipment to air dry. Oxygen helps maintain the passivity film on stainless steel.

NEVER USE HYDROCHLORIC ACID (MURIATIC ACID) ON STAINLESS STEEL

Even diluted, hydrochloric acid can cause corrosion, pitting and stress corrosion cracking of stainless steel.

WATER TREATMENT

To reduce deposits, soften hard water when possible. Installation of certain filters can remove corrosive and distasteful elements. Salts in a properly maintained water softener can also be to your advantage. Contact a treatment specialist if you are not sure of the proper water treatment.

REGULARLY RESTORE & PASSIVATE STAINLESS STEEL

Stainless steel gets its stainless properties from the protective chromium oxides on its surface. If these oxides are removed by scouring, or by reaction with harmful chemicals, then the iron in the steel is exposed and can begin to oxidize, or rust. Passivation is a chemical process that removes free iron and other contaminants from the surface of stainless steel, allowing the protective chromium oxides to re-form.



DESCALING AND SANITIZING

Please follow the instructions below when descaling and sanitizing your machine.

Hold the **CLEAN** button for three seconds to initiate the automatic descaling sequence. The descaling sequence begins by harvesting all the ice from the evaporator. Once the harvest is complete, the machine will beep and display “Add” indicating it is time to add cleaning chemicals to the unit.

After the chemicals have been added, the machine will go through a sequence of rinse and drain cycles to descale the machine and drain all the descaling chemicals from the unit. Once complete, the machine will resume whatever it was doing to prior to descaling. If the machine was making ice prior to pressing the **CLEAN** button, it will resume ice making. If the machine was off before **CLEAN** was pressed, it will turn off when descaling is complete.

NOTE: THE DESCALING SEQUENCE CAN BE CANCELED BY HOLDING THE **CLEAN BUTTON FOR THREE SECONDS.**

A full descaling should be performed every six months. Descaling also involves removing key ice machine parts and rinsing them and the inside of the machine with ice machine descaler.

Sanitizing the ice machine is done to remove any biological contamination that may have occurred. That process is identical to the descaling process above except that a sanitizing agent is used in place of the descaling chemicals.

WARNING: WEAR RUBBER GLOVES AND EYE PROTECTION WHEN HANDLING ICE MACHINE DESCALER OR SANITIZER.

CAUTION: DO NOT MIX DESCALER AND SANITIZER TOGETHER.

PERFORM THE FOLLOWING STEPS EVERY SIX MONTHS TO FULLY DESCAL OR SANITIZE YOUR MACHINE.

PERFORM THE **HIGHLIGHTED** STEPS WHEN ONLY A LIGHT DESCALING OR SANITIZING IS NEEDED.

DESCALING

1. Remove the ice from bin.
2. Press and hold the **CLEAN** button for three seconds.
3. When machine says “Add”, pour 6 fl. oz. of undiluted True Ice® Machine Descaler into the spray compartment behind the water shutters.
4. Wait until the rinsing is complete (30 minutes).
5. Remove the four ice machine parts illustrated below.
6. Create a descaling solution by mixing 10 fl. oz. of undiluted True Ice® Machine Descaler with 1 gallon of water.
7. Using 1/2 of solution, clean removed parts with a brush then soak them for 20 minutes.
8. Use the remaining solution to descale the ice bin, the door, the door gasket, the inside of spray compartment, and the top of evaporator.
9. Rinse all parts with clean water.

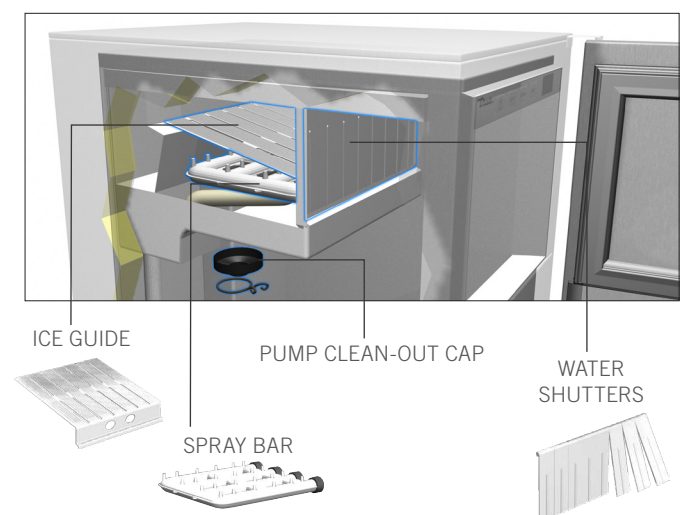

SANITIZING

1. Mix 1.5 fluid ounces (3 tablespoons) of 5.25% hypochlorite solution (chlorine bleach) with 3 gallons of warm water.
2. Use 1/2 of the solution to sanitize the removed parts. Soak the parts in the solution. Do not rinse the parts after sanitizing.
3. Use the remaining solution to sanitize the interior surfaces of the machine and the bin. Do not rinse the sanitized areas.
4. Replace all components.
5. Press and hold the **CLEAN** button for three seconds.
6. When the machine says "Add", pour 2 teaspoons of 5.25% hypochlorite solution (chlorine bleach) into the spray compartment.
7. When the cleaning cycle is complete, the machine will resume its previous mode (either OFF or ICE).
8. Immediately rinse off and dry any exterior areas where sanitizing solution may have spilled.

EXTERIOR CLEANING

Wipe with a damp cloth to remove dust and dirt. Use a solution of mild dish soap and water if a greasy residue persists. Wipe dry with a clean, soft cloth. Never use abrasives, chlorinated or citrus-based cleaners on exterior panels.

WINTERIZING INSTRUCTIONS

Use the following instructions to prepare your ice machine for storage or winterization:

1. Descale and sanitize the ice machine per the instructions in this manual or reference the cleaning and maintenance videos on our YouTube channel at True Residential.
2. Turn off the water supply.
3. Disconnect the incoming water line from the back of the unit.
4. Remove the water filter by twisting it counter clockwise and pulling it out of the unit. Discard the water filter.
5. Drain the evaporator compartment by removing the pump clean-out cap.
6. Pour 1 gallon of propylene glycol (RV antifreeze) into the bin drain to fill the drain pump.
7. Once the drain pump shuts off and all the propylene glycol is drained, unplug the unit or turn off the circuit breaker.
8. Wipe down the interior bin with a dry clean cloth.
9. Re-install the pump clean-out cap.

RESTART INSTRUCTIONS

Use the following instructions to restart your ice machine after winterization:

1. Install a new water filter in the unit.
2. Reconnect the incoming water line and turn on the water supply.
3. Plug in the unit.
4. Descale the ice machine per the instructions on page 39.
5. Press the power button to start ice making.

NOTE: THE FRESH WATER THAT IS INTRODUCED DURING DESCALING AND START-UP WILL FLUSH THE PROPYLENE GLYCOL DOWN THE DRAIN.

FREQUENTLY ASKED QUESTIONS

Q. WHY IS THE MACHINE RUNNING BUT NOT MAKING ANY ICE?

A. The machine will run but not make ice if there is no water supplied to the machine. Check to make sure the water is turned on and that the water filter is installed properly.

Q. WHY DOES THE MACHINE SAY “FUL” BUT THE ICE BIN ISN’T FULL?

A. This is caused by an improperly adjusted thermostat. Adjust the thermostat as needed using the instructions on page 32.

Q. WHY IS THERE WARM AIR COMING FROM THE BOTTOM/FRONT OF THE ICE MACHINE (KICKPLATE AREA)?

A. This is normal as heat dissipation is part of the ice making process for this machine.

Q. WHY IS THE ICE MACHINE MAKING LESS ICE THAN BEFORE?

A. If the ambient temperature or the water temperature goes up significantly, the amount of ice the machine can make will go down. Likewise if the condenser coil becomes obstructed or dirty, ice production will drop. For optimal ice production, make sure the front of the condenser coil, located behind the kickplate, is clean.

Q. WHY DOESN'T THE MACHINE MAKE ICE AFTER I PUT IT THROUGH A CLEAN CYCLE?

A. After cleaning, the machine will resume doing whatever it was doing before cleaning. If you want it to make ice after a clean, make sure it is in the ICE mode when you press the **CLEAN** button to start cleaning.

Q. WHY IS MY ICE MACHINE NOT MAKING FULL CUBES?

A. Your unit may need to be descaled and/or water filter may need to be changed.

TRUE RESIDENTIAL® LIMITED ICE MACHINE WARRANTY

LIMITED 30-DAY COSMETIC WARRANTY

Stainless steel doors and handles are warranted to be free from defective materials and workmanship for a period of thirty (30) days from the date of original retail purchase. Any defects must be reported to the selling dealer within thirty (30) days from the date of original retail purchase. This limited warranty excludes any type of freight / concealed damage.

THREE-YEAR PARTS & LABOR WARRANTY

TRUE warrants to the original purchaser of every new True Ice™ machine, the cabinet and all parts thereof, to be free from defects in material and workmanship under normal and proper use and maintenance as specified by TRUE and upon proper installation and start-up in accordance with the instruction packet supplied with each TRUE unit. TRUE's obligation under this warranty is limited to a period of three (3) years from the date of original installation or thirty-nine (39) months after shipment date from TRUE, whichever occurs first.

Contact the factory regarding warranty for installations in a commercial/light commercial application.

SIX-YEAR SEALED SYSTEM WARRANTY - PARTS & LABOR

TRUE warrants its hermetically sealed system: compressor, evaporator coil, condenser coil, drier, metering device and connecting tubing to be free from defects in both material and workmanship under normal and proper use and maintenance service for a period of six (6) years from the date of original installation but not to exceed six (6) years and three (3) months after shipment from the manufacturer, whichever occurs first.

TERMS APPLICABLE TO EACH WARRANTY

Any part covered under the above warranties that is determined by TRUE to have been defective within the time frame is limited to the repair or replacement, including labor charges, of defective parts or assemblies. The labor warranty shall include standard straight time labor charges only and reasonable travel time, as determined by TRUE.

WARRANTY CLAIMS

All claims for labor or parts must be made directly through TRUE. All claims should include: model number and serial number of ice machine, proof of purchase, and date of installation. In case of warranted compressor, the compressor model tag, or picture of tag must be returned to TRUE along with the above listed information. Warranty labor claim is subject to denial if failed part is requested for return and it is not returned.

WHAT IS NOT COVERED BY THIS WARRANTY

TRUE's sole obligation under this warranty is limited to either repair or replacement of parts, subject to the additional limitations below.

This warranty neither assumes nor authorizes any person to assume obligations other than those expressly covered by this warranty. This warranty does not cover failures related to the water supply, problems in the plumbing going to the unit, or external drain line malfunctions. Also not covered are failures resulting from ambient conditions that are outside the limits specified in the owners manual.

NO CONSEQUENTIAL DAMAGES

TRUE is not responsible for economic loss, profit loss or special, indirect or consequential damages, including without limitation, losses or damages arising from ice loss or ice replacement costs, normal maintenance, after-install adjustments or cleaning or water damage claims whether or not on account of refrigeration failure.



WARRANTY IS NOT TRANSFERABLE

This warranty is not assignable and applies only in favor of the original purchaser / user to whom delivered. Any such assignment or transfer shall void the warranties herein made and shall void all warranties, express or implied, including any warranty of merchantability or fitness for a particular purpose.

IMPROPER USAGE

TRUE assumes no liability for parts or labor coverage for component failure or other damages resulting from improper usage or installation or failure to clean and / or maintain product as set forth in the users manual provided with the unit.

ALTERATION OR NEGLECT

TRUE is not responsible for the repair or replacement of any parts that TRUE determines have been subjected, after the date of manufacture, to alteration, neglect, abuse, misuse, accident, damage during transit or installation, fire, flood, or act of God.

IMPROPER ELECTRICAL CONNECTIONS

TRUE is not responsible for the repair or replacement of failed or damaged components resulting from electrical power failure, high or low voltage, use of extension cords, or improper grounding of the unit.

YOUR RIGHTS UNDER STATE LAW

Some states do not allow the exclusion or limitation of consequential damages or a limitation on how long an implied warranty lasts, so these exclusions or limitations may not apply to you.

This warranty gives you specific legal rights and you may have other rights that vary from state to state.

ENVIRONMENTAL ATTRIBUTES

Any and all environmental attributes, including environmental offset credit rights, with respect to TRUE® refrigeration units manufactured after September 1, 2015, shall remain the property of True Manufacturing Co., Inc. and are not transferred.

OUTSIDE U.S. / CANADA

This warranty does not apply to, and TRUE is not responsible for, any warranty claims made on products sold or used outside the United States or Canada.

SUBMIT WARRANTY CLAIMS TO:

True Residential
Attn: Warranty Dept
2001 East Terra Lane
O'Fallon, MO 63366
Or
TrueResidentialWarranty@truemfg.com



THANK YOU

FOR YOUR PURCHASE

CONTACT US

www.true-residential.com

(636)240-2400 • toll free (888)616-8783



974989

EA | 04/2020 | MISC_2218
TEC_TM_073 REV. B

