



APPLIANCES FOR LIVING

 **ARTUSI**
THE ART OF LIVING

AFGG54W
OPERATION MANUAL

Congratulations, you are now the proud owner of an ARTUSI cooking appliance. Thank you for purchasing ARTUSI and welcome to the ARTUSI Family.

This instruction manual has been specially created to inform you of the full range of features your ARTUSI appliance has to offer and serves as an introduction to getting the very best out of your ARTUSI appliance.

We present detailed information on each of the features your ARTUSI appliance consists of. Once you have read this section you will be able to choose the most appropriate settings for your appliance when cooking different types of food.

We ask you to read the instructions in this booklet very carefully as this will allow you to get the best results from using your appliance. KEEP THE DOCUMENTATION OF THIS PRODUCT FOR FUTURE REFERENCE.

TO REGISTER YOUR PRODUCT WITH ARTUSI, PLEASE FILL OUT THE WARRANTY CARD AT THE END OF THIS BOOKLET AND POST IT TO: **REPLY PAID 83617**
LEICHHARDT NSW 2040

Dear Artusi Customer, please read this user manual carefully before using the product and, keep it permanently at your disposal.

Note: This user manual is prepared for more than one model. Some of the features specified in this Manual may not be available on your appliance.

All our appliances are only for domestic use, not for commercial use. Products marked with (*) are optional.

“THIS APPLIANCE SHALL BE INSTALLED IN ACCORDANCE WITH THE REGULATIONS FORCE AND ONLY USED IN A WELL VENTILATED SPACE. READ THE INSTRUCTIONS BEFORE INSTALLING OR USING THIS APPLIANCE”

“Conforms with the WEEE Regulations.”

SAFETY INSTRUCTIONS

- The appliance becomes hot during operation. Take care not to touch the hot parts inside the oven.
- Please pay attention to children whilst the cooker is in operation, as children do not know the rules of cooker use. In particular, hot surface burners, the oven chamber, grates, the door pane, and pans containing hot liquids standing on the hob may cause burns to children.
- Mind that electrical connection leads from other home appliances (e.g. of a food mixer) do not touch hot parts of the cooker.
- Do not place flammable material into the drawer whilst using the oven, as it may catch a fire.
- Do not leave the cooker unattended when frying. Oils and fats may catch fire due to overheating.
- At the point of boiling, mind to avoid spills on the burner.
- If the cooker is damaged, it may be used again only after the fault has been fixed by a specialist.
- Do not open the tap on the gas connection or cylinder valve before checking that all burner knobs are closed.
- Do not allow the burners to be soiled or liquids to spill on the burners. If soiled, clean and dry burners immediately after they have cooled down.
- Do not put pans directly onto burners.
- Never use the burners or the oven for heating of the room. Never place empty dishes upon the cooking zones.
- Do not place pans with a weight greater than 10kg onto the grate over one burner, or pans with a total weight of over 40 kg on the whole grate.
- Do not open the cooker knobs before already having a lighted match or a gas lighter in your hand.
- Do not put out a burner flame by blowing.
- Before opening the cover, cleaning it of any dirt is recommended. The cooker hob surface should be cooled down before closing the cover.
- A glass cover may crack when heated. Switch off all the burners before lowering the cover. (Cookers with a glass cover).

SAFETY INSTRUCTIONS

- Do not make your own alterations to the cooker in order to adapt it to a different type of gas, move the cooker to another place or make changes to the power supply. These operations may only be carried out by an authorised electrician or fitter.
- Do not use harsh cleaning agents or sharp metal objects to clean the door as they can scratch the surface, which could then result in the glass cracking.
- Keep young children and people not acquainted with the instruction manual away from the cooker.
- IN CASE OF ANY SUSPICION OF GAS LEAKAGE YOU MUST NOT:
Light matches, smoke cigarettes, switch electrical receivers (door bell or light switch) on and off, or use other electric and mechanical devices that create electrical or percussive sparks. In such a case, immediately close the cylinder valve or tap cutting off gas supply, air the room, and then call a person authorized to repair the source of the leakage.
- In the event of any incident caused by a technical fault, disconnect the power (applying the above rule) and report the fault to the service centre to be repaired.
- Do not attach any antenna cords (e.g. radio) to the gas supply.
- In a case of gas escaping from leaky piping and catching fire, close gas supply immediately using a cutting-off valve.
- In a case of gas escaping from a leaky cylinder and catching fire: throw a wet blanket over the cylinder to cool it down and turn off the cylinder valve. After it has cooled down, take the cylinder out to an open space. Do not use the damaged cylinder.
- When the cooker is not to be used for several days, close the main valve on the gas piping; when using a gas cylinder, close it after each use.
- The cooker should not be cleaned using steam equipment.

HOW TO SAVE ENERGY



Using energy in a responsible way not only saves money but also helps the environment. So let's save energy! And this is how you can do it:

- Use proper pans for cooking. A saucepan should never be smaller than a burner crown.
- Ensure burners, the grate the hob are clean. Soils can prevent heat transfer and repeatedly burnt-on spillages can often only be removed by products which cause damage to the environment. In particular, ensure that flame opening in the rings under caps, and opening of burner nozzles are clean.
- Do not uncover the pan too often (a watched pot never boils!). Do not open the cover door unnecessarily often.
- Only use the oven when cooking larger dishes. Meat of up to 1 kg can be prepared more economically in a pan on the cooker burner.
- Make use of residual heat from the oven. cooking time is greater than if the cooking time is greater than 40 minutes it is recommended to switch off the oven 10 minutes before the end time.
- Make sure the oven door is properly closed. Heat can leak through spillages on the door seals. Clean up any spillages immediately.
- Do not install the cooker in the direct vicinity of refrigerators/freezers. Otherwise energy consumption increases unnecessarily.

UNPACKING



During transportation, protective packaging was used to protect the appliance against any damage.

After unpacking, please dispose of all elements of packaging in a way that will not cause damage to the environment. All materials used for packaging the appliance are environmentally friendly; they are 100% recyclable and are marked with the appropriate symbol.

Caution !

During unpacking, the packaging materials (polythene bags, polystyrene pieces, etc.) should be kept out of reach of children.

DISPOSAL OF THE APPLIANCE



Old appliances should not simply be disposed of with normal household waste, but should be delivered to a collection and recycling centre for electric and electronic equipment.

A symbol shown on the product, the instruction manual or the packaging shows that it is suitable for recycling.

Materials used inside the appliance are recyclable and are labeled with information concerning this. By recycling materials or other parts from used devices you are making a significant contribution to the protection of our environment.

Information on appropriate disposal centers for used devices can be provided by your local authority.

DESCRIPTION OF THE APPLIANCE

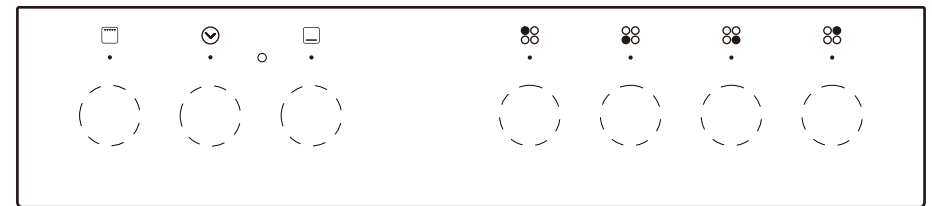
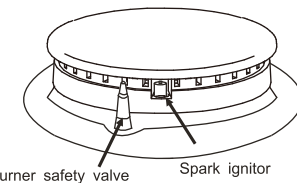
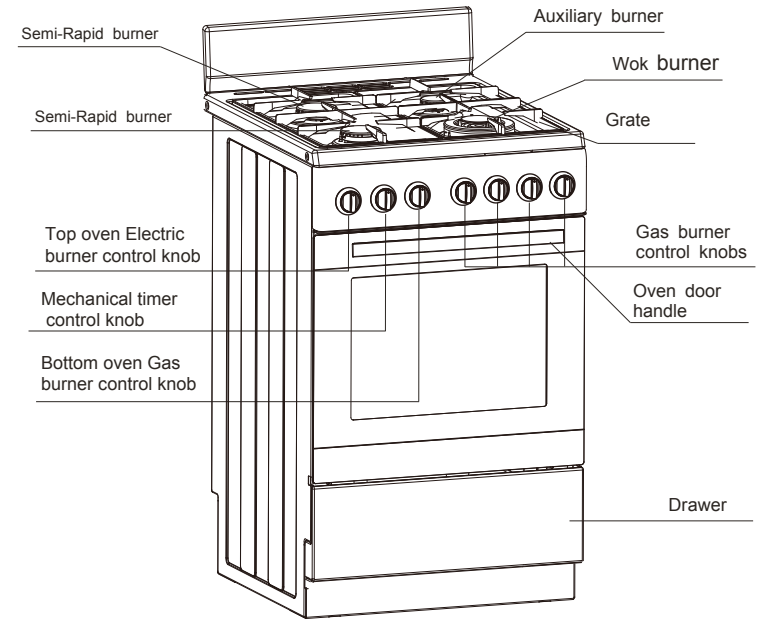

INSTALLATION

The following instructions are addressed to the qualified specialist installing the cooker. These instructions aim at ensuring that installation and maintenance activities are performed as professionally as possible.

▶ Installing the cooker

- The kitchen should be dry and airy and have effective ventilation according to the existing technical provisions.
- The room should be equipped with a ventilation system that pipes away exhaust fumes created during combustion. This system should consist of a ventilation grid or hood. Hoods should be installed according to the manufacturer's instructions. The cooker should be placed so as to ensure free access to all control elements.
- The room should also enable the necessary air supply for proper gas combustion. Air supply should be not less than 2m³/h per 1 kW of burner heat. The air can be delivered from outside by a duct with a section of at least 100 cm², or indirectly from adjoining rooms which are fitted with ventilation ducts leading outside.

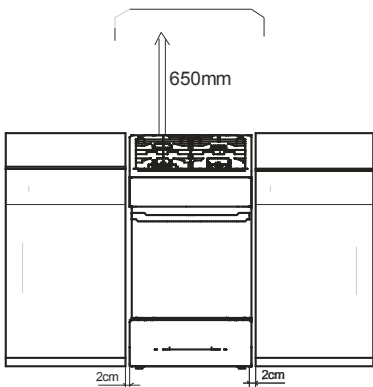

- If the appliance is used intensively and for a long time, it may be necessary to open a window in order to improve ventilation.
- In terms of protection against the overheating of surrounding surfaces, the gas cooker is an X-class appliance and can be built into furniture only up to the level of the cooking hob, that is around 850 mm above the floor. Raising furniture construction over this level is inadvisable. Coating or veneer used on fitted furniture must be applied with a heat resistant adhesive (100°C). This prevents surface deformation or detachment of the coating. If you are unsure of your furniture's heat resistance, you should leave approximately 2 cm of free space around the cooker. The wall behind the cooker should be resistant to high temperatures. During operation, its back side can warm up to around 50°C above the ambient temperature.
- The cooker should stand on a hard, even floor (do not put it on a base).
- Before you start using the cooker it should be leveled, which is particularly important for fat distribution in a frying pan. To this purpose, adjustable feet are accessible after removal of the drawer. The adjustment range is +/- 5mm.

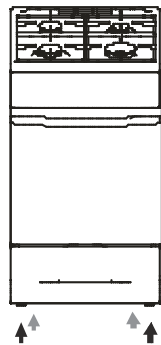

INSTALLATION

- Install the cover. Take the cover and cooker out of the packaging. Select a proper place, and steadily level the cooker. To fit the rear panel/splashback, slide the lugs on the bottom of the panel into the matching slots on the rear of stove and fix with screws provided.

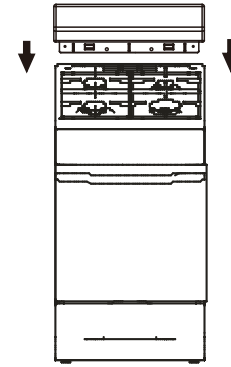

Caution!

The splashback is fixed to the rear wall of cooker. kindly please REMOVE before installation.

Pic: A

Unscrew the splashback from the rear wall of the cooker, Pic: A and fit to the rear of the cooktop section of the cooker, Pic: B

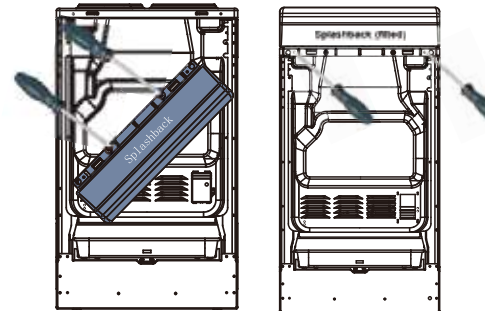

Pic: A

Pic: B

▶ Gas connection

Caution!

The cooker should be connected to a gas supply of the particular type of gas that the appliance is manufactured to function with. Information about the type of gas that the cooker has been adapted to by the factory is shown on the data plate. The cooker should be connected exclusively by an appropriately authorized fitter and only he or she has the right to adapt the cooker to a different type of gas.

Fitting guidelines

A fitter should:

- have a gas fitter's authorisation
- be acquainted with the information included on the data plate of the cooker about the type of gas to which the cooker is adapted; the information should be compared with gas supply conditions at the place of installation.
- check:
 - airing efficiency, that is efficiency of air exchange in the rooms,
 - tightness of gas fitting connections,
 - effectiveness of all functional elements of the cooker,
 - if the electricity supply is adapted to function with a safety ground lead (zero)
- provide the user with a connection certificate and give him or her instructions in cooker use.

Caution!

The cooker may only be connected to a liquid gas cylinder or the existing gas supply by an authorized fitter, observing all safety rules.

INSTALLATION

Hose connection

- Gas cooker is equipped with the gas connection on the right side with exterior thread ISO 7-R1/2.
- Certain appliance are supplied with the attached liquid gas coupling and the sealing gasket.
- The connection R1/2 must be gripped tight during the connection procedure to prevent it from revolving.
- Use metal or non metal gaskets for connection packing. Gaskets are intended for single use only.
- The deformation of the non-metal gasket connection thickness during tightening may not exceed 25%.
- Connect the appliance to the gas coupling by means of certified flexible hose. The hose may not touch the bottom panel of the appliance or the rear panel and ceiling of the oven.
- Connect the appliance in accordance with the regulations of the local gas supplier.

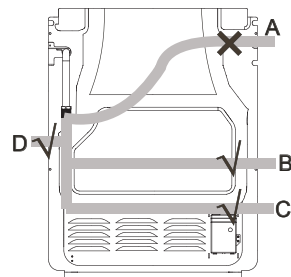

Beginning of operation

Start using the appliance in accordance with the instructions for use. Lit up all burners and check the stability of the flame with high and low setting. Adjust air intake if necessary. After that, take time and explain the operation and control of the appliance to the user and read with him the instructions for use.

Liquefied gas connection

- Pipe coupling liquefied
- Gasket
- Connection R 1/2

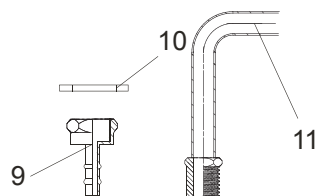

Caution!

On completion of the cooker installation, the tightness of all connections should be checked, e.g. applying water with soap. Do not use fire to check tightness.

Flexible hose connection

In case the appliance is connected by means of a flexible hose the position A of the hose is not permissible. In case the connection hose is made of metal, position A is permissible.

Gas connection

- Accessibility:** Make sure that it is possible to run gas lines to the gas connection point of the appliance. The gas connection point must be accessible without having to remove the oven. If a flexible hose is used, the connection point must also be accessible without having to remove the oven.
- Natural gas connection:** Using the supplied gas regulator, remove the dust seals on the inlet and outlet ports and position the "OUT" port of the regulator towards the gas inlet pipe of the oven.

INSTALLATION

Using a suitable thread sealant, screw the regulator on and ensure that it is orientated with easy access to the test point. Connect the appropriate Natural Gas supply to the "IN" port of the gas regulator.

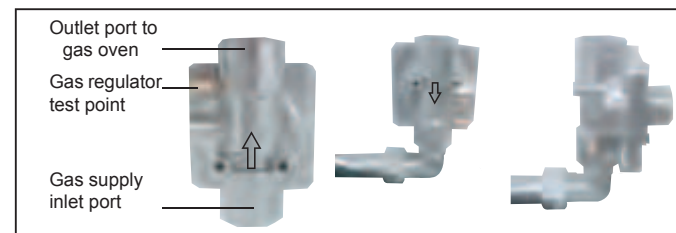

- ULPG connection:** Using the supplied gas regulator, remove the dust seals on the inlet and outlet ports and position the outlet port of the regulator towards the gas inlet pipe of the oven. Using a suitable thread sealant, screw the regulator on and ensure that it is orientated with easy access to the test point. Connect the appropriate ULPG supply to the inlet port of the gas regulator.

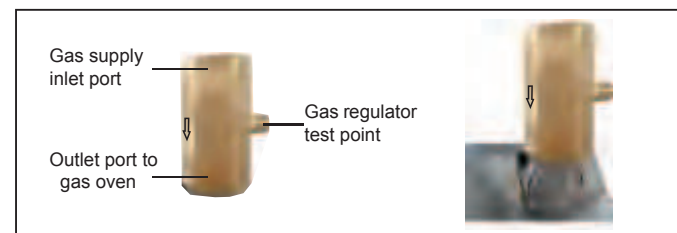

▷ Adapting the cooker to another type of gas

This operation may only be carried out by an appropriately authorised fitter. The cooker is supplied with natural gas (G20/20mbar). If the cooker is to be supplied with differs from the gas provided for the cooker by the manufacturer, burner nozzles must be exchanged and the flame needs to be adjusted.

In order to adapt the cooker to burn a different type of gas, you should:

- exchange nozzles (see tables below),
- adjust the "economical" flame.

Caution!

The cookers provided by the manufacturer have burners which are factory -adapted to use the gas specified on their data plates and guarantee cards.

Burner

Upright	Burner	Gas type	Injector Size(mm)	TPP (kPa)	NGC (MJ/h)
540mm	Auxiliary	Natural gas	0.87	1.0	3.6
	Semi-rapid		1.10x2		6.3x2
	Wok		1.65		12.6
	Oven		1.39		10.8
	Auxiliary	Universal LPG	0.53	2.75	3.6
	Semi-rapid		0.68x2		6.3x2
	Wok		0.95		12.6
	Oven		0.89		10.8

INSTALLATION

Burner flame	Re-arming from liquid gas to natural gas	Re-arming from natural gas to liquid gas
Full	1. Exchange a burner nozzle for the appropriate type according to the nozzle table	1. Exchange a burner nozzle for the appropriate type according to the nozzle table.
Economical	2. Unscrew an adjusting bolt slightly and adjust the flame size.	2. Screw in an adjusting bolt slightly to the end and check the flame size.

In order to perform adjusting operations, take off the knobs. Adjusting elements of the oven burner are accessible after drawing out the oven chamber floor.

Surface burners applied do not require adjustment of primary air. A correct flame has distinct internal cones of blue and green colour. A short, humming flame or long, yellow and smoking one, without clearly outlined cones, shows improper quality of gas in the household piping or a damaged or soiled burner. In order to check a flame, heat a burner for around 10 minutes with a full flame, and next turn the valve knob to the economical flame position. The flame should not go out or jump onto the nozzles.

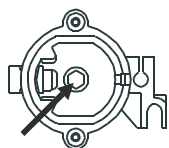

Exchange of a burner nozzle : unscrew the nozzle with special socket spanner No 7 and replace with a new one according to a type of gas (see tables)

In cookers with a safety device, a knob with a surface burner safety valve is used, fig.B. Knobs should be adjusted with the burner switched on and set to the economical flame position, using an adjustment screwdriver of the 2.5mm size.

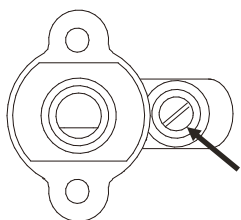

Fig. B
A knob with a surface burner safety valve

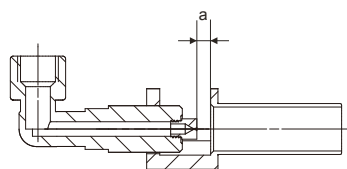

Fig.C
Adjust the air flow of the oven burner

Caution !

- Adapting the appliance to a different type of gas than that indicated by the manufacturer of the cooker on the data plate, or purchasing a cooker for a different type of gas than supplied to the house, is exclusively the responsibility of the user and the fitter.
- After adjustment is completed, place a label indicating the type of gas to which the cooker is now adapted.

OPERATION

▷ Before first use

- Remove packaging elements,
- Gently (slowly) remove labels from the oven door, trying not to break the glue tape. If any visible trace is left on the glass, warm up the oven chamber (see below), spray the warmed-up glass with a glass cleaner, and wipe off with a soft cloth.
- Empty the drawer, clean off factory preservatives from the oven chamber,
- Take out and wash the oven fittings with warm water and a little washing-up liquid,
- Switch on the ventilation in the room or open a window,
- Heat the oven (to a temperature of 250°C , for approximately 30 min.), remove any stains and wash carefully.
- When handling the cooker, follow the safety instructions carefully.

The oven chamber should only be washed with water and a small amount of washing -up liquid .

▷ How to use surface burners

Choice of cookware

Mind that the diameter of a pan base is always larger than the burner flame crown, and that the pan itself is covered. The recommended pan diameter is around 2.5 to 3 times larger than the burner diameter, that is, for:

- An auxiliary burner - a pan with a diameter of 90 to 150 mm,
- A medium burner - a pan with a diameter of 160 to 220 mm,
- A large burner - a pan with a diameter of 200 to 240 mm, and the pan height should not be greater than its diameter.

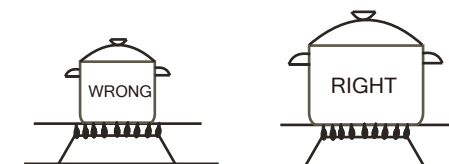

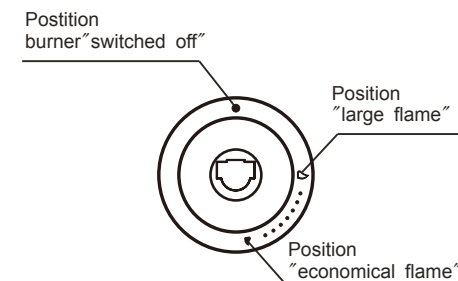

Gas burner control knobs



OPERATION

Ignition without an ignitor



- Light a match.
- Press in the knob to the end and turn it left to the “large flame” position ,
- Ignite gas with a match.,
- Set required flame size (e.g. “economical” ) ,
- Switch off the burner after finishing cooking, turning the knob right (to the off position ).

Knob ignition

- Press in the knob to the end and turn it left to the “large flame” position ,
- Hold until gas is lit,
- After the flame is lighted release the pressure on the knob and set a required flame size.

Selection of the appropriate flame

A correctly adjusted burner has a light blue flame with a clearly visible internal cone. Selection of flame size depends on the position of the burner knob which has been set:

-  Large flame
-  Small flame (“economical flame”)
- Burner switched off (gas supply is cut off)

Depending on requirements, flame size can be set in a continuous manner.

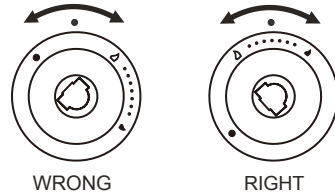

Caution !

In cooker models equipped with a surface burner safety valve, hold the knob pressed down to the end when igniting for 10 seconds at the “large flame” position to activate the safety device.

If the ignition device is out of order, either due to power failure or humid ignition device, use a match or a lighter to ignite the gas.

- Keep the button pressed for approximately 10 second after ignition to stabilize the flame.
- If you failed to ignite the burner after 15 seconds. Shut the burner off and wait for at least one minute before the next attempt.

▶ Mechanical timer (Only for main oven)

When using the oven, you must set food cooking time.

1. Turn mechanical timer to the time position you want. 

2. Turn function knob to the function position you want. 

3. Turn temperature knob to the temperature position you want. 

OPERATION

4. After above operation, oven knob runs normally.
5. When oven works till pre-set time, timer will have sound which means the cooking is finished.

If you don't want the oven work controlled by the mechanical timer, you can turn the mechanical timer to the position.



Caution !

When selecting any oven function, the oven will only be switched on after the temperature has been set by the temperature selection knob.



Static Grill
(Double Grill)

When the “combined grill” is active it enables grilling with the grill and with the top heater switched on at the same time.

This function allows a higher temperature at the top of the cooking area, which causes more intense browning of the dish and permits larger portions to be grilled.



Separate oven lighting

By setting the knob to this position the lighting inside the oven is switched on, e.g. use when washing the oven chamber

Caution !

At this oven function knob position. The oven is not being warmed up.

Caution !

- Button positions between ● in  are not recommended. In these positions the flame is not stabilized and may be extinguished.

- If the flame goes out repeat the procedure.
- If the burner flame goes out (for whatever reason), shut the burner off and wait for at least one minute before next attempt.
- Before igniting the burners cover them with appropriate cookware.

Operation of the burner protection valve

Some models are equipped with an automatic system that cuts off gas supply to a burner when the flame has disappeared.

This system protects the cooker against gas leakage when the flame on a burner goes out e.g. in case of spillage. The user's intervention is needed to re-ignite the burner.

▶ Oven

Oven functions and operation

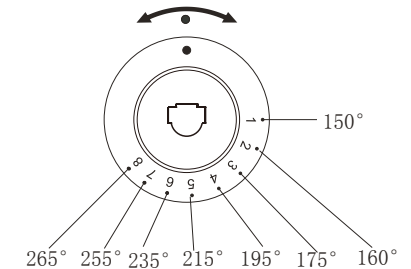

Oven is equipped with gas valve with temperature regulator and anti-outflow protection. To ignite the oven, as in the description below, keep down the pressed knob during about 3 s, this is the time necessary to warm the sensor and to make the protection function. If the flame goes out, repeat ignition operations after a lapse of 3 sec. if the flame does not start burning within 10 sec., repeat the ignition operation after lapse of about 1 min, i.e. after the oven ventilation.

OPERATION

To ignite the bottom burner

- Strike a match,
- Press down the knob to the stop and turn left to the position corresponding to the temperature chosen,
- Put the match to the ignition opening (see the figure below) and keep the knob pressed down about 3 sec. from the gas ignition moment. If the flame has gone out, repeat the ignition operation after lapse of 3 sec.

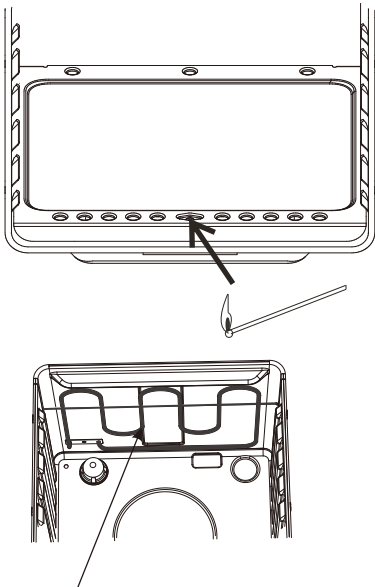

Electric grill top element

Caution!

The temperature control is possible at closed oven door only.

Turn the knob right to the stop in order to turn the oven off.

Oven guide levels

Baking pans and accessories (oven grid, baking tray, etc) may be inserted into the oven in 5 guiding levels. Appropriate levels are indicated in the tables that follow. Always count levels from the bottom upwards!

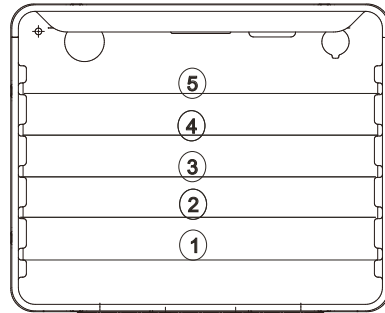

ELECTEIC GRILL

Grilling with electric heater (position)

- Take extra precautions when grilling. Intensive heat from heater makes the oven and the accessories extremely hot. Use thick protective gloves and barbecue accessories!
- Always protect your eyes.
- **Do not let the children stay in the vicinity of the grill.**

Tips for grilling

- Grilling should be carried out with the oven door closed.
- Oil the grill grid before placing the food, otherwise food might stick to the grid.
- Place the grid with meat into the suitable guide, then place the grease pan one level lower, to intercept the dripping grease pan one level lower, to intercept the dripping grease and meat juice.
- Turn the meat round after half of the roasting time has expired. Thinner slices will require only one turn, for larger chunks you might need to repeat the procedure.
- Always use barbecue tongs to avoid piercing the meat and losing natural meat juice.
- Clean the grill, the oven and the accessories each time after use.

BAKING IN THE OVEN

Tips for grilling

- Grilling is carried out with the oven door open.
- Insert the protective shield under the control panel.
- During grilling the oven thermostat is off, and the grill burner operates at full power.
- Grilling tables indicate the recommended temperature, guide levels and quality of meat.

- Pre-heating of oven for grilling is not necessary.
- Oil the grill grid before placing the food, otherwise food might stick to the grid.
- Place the meat upon the grid, then place the grease pan one level lower, to intercept the dripping grease and meat juice.

- Place the meat chunk in the middle of the grid rack, below the burner.
- Turn the meat round after half of the roasting time has expired. Thinner slices will require only one turn, for larger chunks you might need to repeat the procedure.
- Always use barbecue tongs to avoid piercing the meat and losing natural meat juice.

- Dark beef meat is grilled quicker than lighter pork or veal.
- Clean the grill, the oven and the accessories each time after use.

Grill table for gas burner

Type of meat for grill	Weight (in grams)	Guide level (from bottom up)	Grill time (in min)
Meat and sausages		4	25-30
2 beefsteaks	400	4	25-30
2 pork scrag fillets	350	4	25-30
2 pork chops	400	4	18-22
4 lamb cutlets	700	4	18-23
4 grill sausages	400	4	15-20
2 slices of meat cheese	400	3	35-45(1 side) 35-45(1 side)
1 chicken, halved	1400	170	30-50
Fish			
Salmon fillets	400	4	15-20
Fish in aluminum foil	500	4	15-20
Toast			
4 slices of white bread	200	4	5 - 7
2 slices of wholemeal	200	4	6 - 8
Toast sandwich	600	4	6 - 9

BAKING IN THE OVEN

Baking

- We recommend using the baking trays which were provided with your cooker which should be put on the drying rack;

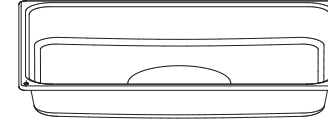

- Before the cake is taken out of the oven, check if it is ready using a wooden stick (if the cake is ready the stick should come out dry and clean after being inserted into the cake);
- After switching off the oven it is advisable to leave the cake inside for about 5 min.;
- The baking parameters given in tables are approximate and can be corrected based on your own experience and cooking preferences;
- If information given in recipe books is significantly different from the values included in this instruction manual, please apply the instructions from the manual.

CAKE TYPE	TEMPERATURE (°C) WARMED UP	TEMPERATURE (°C)	BAKING TIME IN MINUTES	LEVEL FROM THE BOTTOM
Fruit cake	170	160	60-70	2
Victoria sponge	170	150-160	20-40	2-3
Sponge layer cake	170	150-160	20-30	2-3
Buns	180	170	30-50	3
Teacake	180	180	40-50	3
Cake (crispy base)	200	180	40-60	3
Puff pastry	230-250	200-220	15-20	3

BAKING IN THE OVEN

▷ Roasting meat

- Cooking meat weighing over 1 kg in the oven, but smaller pieces should be cooked on the gas burners.
- Use heatproof ovenware for roasting, with handles that are also resistant to high temperatures;
- When roasting on the drying rack or the grate we recommend that you place a baking tray with a small amount of water on the lowest level of the oven;
- It is advisable to turn the meat over at least once during the roasting time and during roasting you should also baste the meat with its juices or with hot salty water - do not pour cold water over the meat.

TYPE OF MEAT	LEVEL FROM THE BOTTON	TEMPERATURE(°C)	TIME* IN MINUTES
BEEF			Per 1 cm
Roast beef or fillet rare	3	250	12-15
Oven warmed up juicy ("medium")	3	250	15-25
Oven warmed up "well done"	3	210-230	25-30
Oven warmed up roast joint	2	200-220	120-140
PORK			
Roast joint	2	200-210	90-140
Ham	2	200-210	60-90
Fillet	3	210-230	25-30
VEAL	2	200-210	90-120
LAMB	2	200-220	100-120
VENISON	2	200-220	100-120
POULTRY			
Chicken	2	220-250	50-80
Goose (approx. 2 kg)	2	190-200	150-180
FISH	2	210-220	40-55

- **The figures presented in the table refer to a portion of 1kg**, if the portion is larger than that an additional 30-40 minutes should be added for each additional kilogram.

CLEANING AND MAINTENANCE

By ensuring proper cleaning and maintenance of your cooker you can have a significant influence on the continuing fault-free operation of your appliance.

Before you start cleaning, the cooker must be switched off and you should ensure that all knobs are set to the "●" position. Do not start cleaning until the cooker has completely cooled.

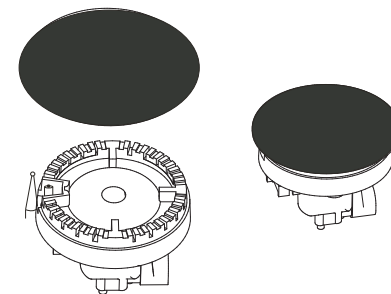

Front side of the casting

For cleaning of frontal part of the cooker use the usual cleaning agents and follow the manufacturer's instructions.

Never use any aggressive cleaning agents or dish cleaning accessories which might cause scratches.

Caution!

Crown caps are coated with black enamel. Discoloration of caps, due to high temperatures, is inevitable, but it has no adversary effect on normal operation of burners.

Enamel coated and plastic surface

Clean the knobs and handles with soft cloth and liquid cleaners, intended for use of smooth enamel surfaces.

▷ Oven

- The oven should be cleaned after every use. When cleaning the oven the lighting should be switched on to enable you to see the surfaces better.
- The oven chamber should only be washed with warm water and a small amount of washing-up liquid.
- After cleaning the oven chamber wipe it dry.

▷ Cooktop

Gas grid, cooking area and burner components should be cleaned with warm water and mild detergent for manual washing of dishes.

Thermal element and ignition device should be cleaned with soft brush. To ensure perfect operation, these elements must always be thoroughly clean.

Clean the crown and the crown cap. Always keep the gas outlets nozzles on the burner crown free of dirt.

Upon completion of cleaning wipe all components dry and replace them carefully to their respective slots. Oblique position of components may cause troubled ignition of burners.

Caution!

Do not use cleaning products containing abrasive materials for the cleaning and maintenance of the glass front panel.

CLEANING AND MAINTENANCE

▷ Changing the Oven Lamp

Before any maintenance is started involving electrical parts, the appliance must be disconnected from the power supply. If the oven has been in use, let the oven cavity and the heating elements cool down before attempting any maintenance.

Changing the bulb

- Unscrew the protective cover. We recommend that you wash and dry the glass cover at this point.
- Carefully remove the old bulb and insert the new bulb suitable for high temperatures (300°C) having the following specifications: 220-240V, 50Hz, 25W, G9 fitting.
- Refit the protective cover.

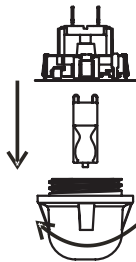

IMPORTANT

Never use screwdrivers or other utensils to remove the light cover. This could damage the enamel of the oven or the lampholder. Remove only by hand.

IMPORTANT

Never replace the bulb with bare hands as contamination from your fingers can cause premature failure. Always use a clean cloth or gloves.

Please note:

The bulb replacement is not covered by your guarantee

▷ Door removal

In order to obtain easier access to the oven chamber for cleaning, it is possible to remove the door, to do this, tilt the safety catch part of the hinge upwards, close the door lightly, lift and pull it out towards you, in order to fit the door back on to the cooker, do the inverse. When fitting, ensure that the notch of the hinge is correctly placed on the protrusion of the hinge holder. After the door is fitted to the oven, the safety catch should be carefully lowered down again, if the safety catch is not set it may cause damage to the hinge when closing the door.

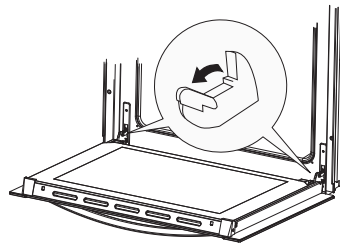

Tilting the hinge safety catches

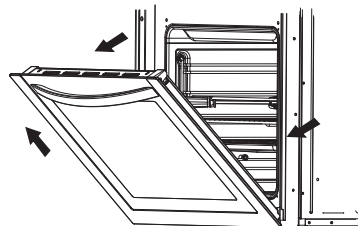

Door removal

CLEANING AND MAINTENANCE

▷ Removal of the internal glass panel

Unscrew and unfasten the plastic latch that is in the corner at the top of the door. Next take out the glass from the second blocking mechanism and remove. After cleaning, insert and block the glass panel, and screw in the blocking mechanism.

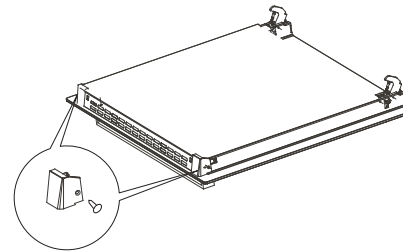

Removal of the internal glass panel

▷ Install door

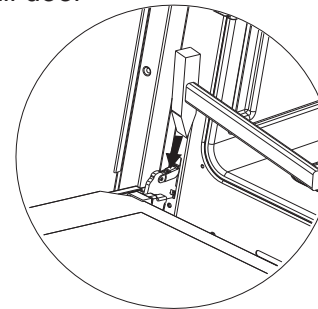

▷ Regular inspections

Besides keeping the cooker clean, you should:

- Carry out periodic inspections of the control elements and cooking units of the cooker, after the guarantee has expired you should have a technical inspection of the cooker carried out at a service centre at least once every two years.
- Fix any operational faults.
- Carry out periodical maintenance of the cooking units of the cooker.

Caution!

All repairs and regulatory activities should be carried out by the appropriate service centre or by an appropriately authorized fitter.

OPERATION IN CASE OF EMERGENCY

In the event of an emergency, you should:

- Switch off all working units of the cooker
- Disconnect the mains plug
- Call the service centre
- Some minor faults can be fixed by referring to the instructions given in the table below. Before calling the customer support centre or the service centre check the following points that are presented in the table.

PROBLEM	REASON	ACTION
Burner flame is not steady.	Wrong setting of gas.	Expert should set the gas escape properly!
Burner flame suddenly changes	Incorrect assembly of burner components.	Assemble the burner components correctly!
The flame goes off after ignition.	Early release of control button. Control button is not pushed in firmly.	Keep the button pressed longer. Before releasing the button, give it one final solid push.
The color of the cooking zone gas grid has changed.	Normal situation, caused by the high temperature.	Clean the grid with metal cleaning agents.
Electric operations are generally disturbed.	Fuse is burned.	Check the fuse in the fuse box, and replace if required.
Electric ignition of burners does not function.	Food residues or detergent block the contact between the ignition device and the burner.	Open and clean carefully the opening between the ignition device and the burner.
Burner crown caps look ugly.	Usual staining.	Clean the crown cap with metal cleaning agents.
Dew forms at oven door glass during heating up.	Normal situation, caused by the temperature difference.	No remedy; it does not impede normal operation.
...if you detect smoke during roasting?	Roasting temperature too high	Reduce roasting temperature.
	Thermostat failure.	Experts should replace the thermostat.
Oven is excessively stained during roasting.	Roasting temperature is too high. Grid rack and grease tray are incorrectly placed.	Reduce the roasting temperature, Place the grid above the grease tray and insert them both in the guide.
Liquid or pastry dough is lifted to on side.	The appliance is not leveled.	Level the appliance into horizontal position by setting the adjustable legs.
Baking results are disappointing.	Wrong oven setting.	Select correct oven setting according to the instructions from the baking tables.
Flat cake is too light from below.	Baking pan was placed in top of roasting pan.	Place the baking tray upon the grid rack.
Pastry is too dry.	Temperature is too low. Baking time too long.	Set higher oven temperature duce baking time.
Pastry is slippery, smeary and mellow. Meat is rare in the middle.	Baking temperature is too high. Roasting time is too short. Excessive quantity of liquid in dough.	Reduce the temperature- baking time may not be reduce d by setting higher temperature (roasted from the outside, raw from the inside) select longer baking time, let the dough rise longer. Add less liquid to the dough.

TECHNICAL INFORMATION

Type	AFGG54W
Dimensions: height/width/depth(mm) Gas inlet: right rear 150mm from top	900/540/600

Injector Table

Upright	Burner	Gas type	Injector Size(mm)	TPP (kPa)	NGC (MJ/h)
540mm	Auxiliary	Natural gas	0.87	1.0	3.6
	Semi-rapid		1.10x2		6.3x2
	Wok		1.65		12.6
	Oven		1.39		10.8
	Auxiliary	Universal LPG	0.53	2.75	3.6
	Semi-rapid		0.68x2		6.3x2
	Wok		0.95		12.6
	Oven		0.89		10.8

Total Gas Consumption

540mm
Natural gas 28.8MJ/h - Universal LPG 28.3MJ/h



Worldwide Appliances Pty Limited

A.B.N. 45868077422

Office:

48-50 Moore Street, Leichhardt N.S.W 2040

Post:

Locked Bag 3000, Annandale, N.S.W 2038

P: 1300 694 583

WARRANTY REGISTRATION

Your ongoing satisfaction with your artusi product is important to us. We ask that you complete the enclosed Warranty Registration Card and return it to us so that we have a record of the artusi product purchased by you.

PRIVACY

Worldwide Appliances respects your privacy and is committed to handling your personal information in accordance with the National Privacy Principles and the Privacy Act 1988 (Cth). A copy of the Worldwide Appliances Privacy Policy is available at www.artusi.com.au. Worldwide Appliances will not disclose any personal information set out in the Warranty Registration Card ("Personal Information") without your consent unless required by:

1. law;
2. any Worldwide Appliances related company;
3. any service provider which provide services to artusi or assist artusi in providing services (including repair and warranty services) to customers. Our purpose in collecting the Personal Information is

to keep a record of the artusi product purchased by you, in order to provide a better warranty service to you in the unlikely event that there is a problem with your artusi product. Worldwide Appliances may contact you at any one or more of the address, email address or telephone numbers set out in the Warranty Registration

Card. Please contact artusi on 1300 694 583 should you not wish to be contacted by Worldwide Appliances.

WARRANTY

1. Warranty

Worldwide Appliances warrants that each artusi product will remain, for a period of either 12 months or 24 months of warranty. All Warranties are valid from the original date of purchase, And warranty claims must be accompanied by the proof of purchase.

24 months warranty products:

All Built-in Appliances – Limited to Ovens, Gas, Induction and Electric Cooktops, and All Rangehoods

Freestanding Cookers - Gas and Electric Models (900mm Width)

Dishwashers - Freestanding, Fully Integrated, Semi Integrated and built-in

12 months warranty products:

Freestanding Cookers - Gas and Electric Models in 50cm, 54cm and 60cm Widths

Portable Appliances* – Benchtop Models and Portable Gas Models

2. What is not Covered by the Warranty.

The Warranty does not apply if an artusi product is defective by a factor other than a defect arising in the manufacture of the artusi product, including but not limited to:

- (a) damage through misuse (including failure to maintain, service or use with proper care), neglect, accident or ordinary wear and tear (including deterioration of parts and accessories and glass breakage);
- (b) use for purpose for which the artusi product was not sold or designed;
- (c) use or installation which is not in accordance with any specified instructions for use or installation;
- (d) use or operation after a defect has occurred or been discovered;
- (e) damage through freight, transportation or

handling in transit (other than when Worldwide Appliances is responsible);

(f) damage through exposure to chemicals, dusts, residues, excessive voltage, heat, atmospheric conditions or other forces or environmental factors outside the control or Worldwide Appliances;

(g) repair, modification or tampering by the purchaser or any person other than Worldwide Appliances, an employee of Worldwide Appliances or an authorised artusi service contractor*;

(h) use of parts, components or accessories which have not been supplied or specifically approved by artusi.

(i) damage to surface coatings caused by cleaning or maintenance using products not recommended in the artusi product handbook provided to the purchaser upon purchase of the artusi product;

(j) damage to the base of an electric oven due to items having been placed on the base of the oven cavity or covering the base, such as aluminium foil (this impedes the transfer of heat from the element to the oven cavity and can result in irreparable damage); or

(k) damages, dents or other cosmetic imperfections not affecting the performance of the artusi in respect of an artusi product purchased as a "factory second" or from display. The Warranty does not extend to light globes used in artusi products.

3. Domestic Use

Each artusi product is made for domestic use. This Warranty may not extend to artusi products used for commercial purposes.

4. Time for Claim under the Warranty

You must make any claim under this Warranty within twenty eight (28) days after the occurrence of an event which gives rise to a claim pursuant to the Warranty, by booking a service call on the telephone number below.

Continued over...

5. Proof of Purchase

Customers must retain proof of purchase in order to be eligible to make a warranty claim in respect of an artusi product.

6. Claiming under the Warranty

Customers will bear the cost of claiming under this Warranty unless Worldwide Appliances determines the expenses are reasonable, in which case the customer must claim those expenses by providing written evidence of each expense to Worldwide Appliances at the address on the Warranty Registration Card.

7. Statutory Rights

(a) These terms and conditions do not affect your statutory rights.

(b) The limitations on the Warranty set out in this document do not exclude or limit the application of the consumer guarantees set out in the Act or any other equivalent or corresponding legislation in the relevant jurisdiction where to do so would:

- (i) contravene the law of the relevant jurisdiction; or
- (ii) cause any part of the Warranty to be void.

(c) Worldwide Appliances excludes indirect or consequential loss of any kind (including, without limitation, loss of use of the artusi product) and (other than expressly provided for in these terms and conditions) subject to all terms,

conditions and warranties implied by custom, the general law, the Act or other statute.

(d) The liability of Worldwide Appliances to you for a breach of any express or non-excludable implied term, condition or warranty is limited at the option of Worldwide Appliances to:

- (i) replacing or repairing the defective part of the artusi product;
- (ii) paying the cost of replacing or repairing the defective part of the artusi product;
- (iii) replacing the artusi product; or
- (iv) paying the cost of replacing the artusi product.

(e) Our goods come with guarantees that cannot be excluded under the Australian Consumer Law. You are entitled to a replacement or refund for a major failure and for compensation for any other reasonably foreseeable loss or damage. You are also entitled to have the goods repaired or replaced if the goods fail to be of acceptable quality and the failure does not amount to a

major failure.

8. Defects

Any part of an artusi product deemed to be defective and replaced by Worldwide Appliances is the property of Worldwide Appliances. Worldwide Appliances reserves the right to inspect and test artusi products in order to determine the extent of any defect and the validity of a claim under the Warranty.

*To locate your closest artusi authorised service agent please contact us on 1300 652 100 or visit www.artusi.com.au

ALL SERVICE CALLS MUST BE BOOKED THROUGH AN AUTHORISED DEALER OR WARRANTY DEPARTMENT ON 1300 652 100 OR stokesaps.com.au/artusi-service 01032014



Warranty Card tear off

WARRANTY REGISTRATION CARD 01052013

Please complete and send to ARTUSI at: REPLY PAID 83617
LEICHHARDT NSW 2040

Last Name:		First Name:	
Address:			
State:	Postcode:	Email:	
Home Phone:		Mobile:	
Purchase Date: / /		(Please attach proof of purchase to validate warranty)	

MODEL NUMBER	SERIAL NUMBER <small>(if you cannot locate the serial number please call ARTUSI on 1300 694 583)</small>
1	
2	
3	
4	

01032014





DISCLAIMER

Worldwide Appliances PTY LTD, trading as ARTUSI, is continually seeking ways to improve the design specifications, aesthetics and production techniques of its products. As a result alterations to our products and designs take place continually. Whilst every effort is made to produce information and literature that is up to date, this brochure should not be regarded as an infallible guide to the current specifications, nor does it constitute an offer for the sale of any particular product. Product dimensions indicated in our literature is indicative only. Actual product only should be used to define dimension cutouts. Distributors, and retailers are not agents of ARTUSI and are not authorised to bind ARTUSI by any express or implied undertaking or representation.

ARTUSI OFFICES ARE OPEN DAILY FROM 9AM-5PM AND SATURDAYS 10AM-4PM

NSW & ACT (HEAD OFFICE)
48-50 MOORE STREET
LEICHHARDT
F 02 8569 4699

VIC, TAS & SA
1211 TOORAK ROAD
CAMBERWELL
F 03 9809 2155

QLD
1/42 CAVENDISH ROAD
COORPAROO
F 07 3397 0850

WA & NT
UNIT 10/55 HOWE STREET
OSBORNE PARK
F 08 9201 9188

NZ
PO BOX 11160
SOCKBURN CHRISTCHURCH
F 03 344 5906

P: 1300 649 583

ARTUSI.COM.AU

