

SEARS

OWNER'S MANUAL

Model Nos.
233.55345590
233.55445590
233.55545590

Caution:
Read and follow
all **Safety Rules** and
Operating Instructions
before first use of this
Product.



Kenmore

RANGE HOOD

- ◆ **Safety Instructions**
- ◆ **Warranty**
- ◆ **Operation**
- ◆ **Care and Maintenance**
- ◆ **Wiring Diag.**
- ◆ **Parts List**

Sears, Roebuck and Co., Hoffman Estates, IL 60179 U.S.A.

READ AND SAVE THESE INSTRUCTIONS

SAFETY INSTRUCTIONS

WARNING

TO REDUCE THE RISK OF FIRE, ELECTRICAL SHOCK, OR INJURY TO PERSONS, OBSERVE THE FOLLOWING:

1. Use this unit only in the manner intended by the manufacturer. If you have questions, contact the manufacturer at the address or telephone number listed in the warranty.
2. Before servicing or cleaning unit, switch power off at service panel and lock service panel to prevent power from being switched on accidentally.
3. Installation work and electrical wiring must be done by a qualified person(s) in accordance with all applicable codes and standards.
4. Sufficient air is needed for proper combustion and exhausting of gases through the flue (chimney) of fuel burning equipment to prevent backdrafting. Follow the heating equipment manufacturer's guideline and safety standards such as those published by the National Fire Protection Association (NFPA), and the American Society for Heating, Refrigeration and Air Conditioning Engineers (ASHRAE), and the local code authorities.
5. When cutting or drilling into wall or ceiling, do not damage electrical wiring and other hidden utilities.
6. Ducted fans must always be vented to the outdoors.
7. To reduce the risk of fire, use only metal ductwork.
8. This unit must be grounded.

TO REDUCE THE RISK OF A RANGE TOP GREASE FIRE:

1. Keep fan, filters and grease laden surfaces clean.
2. Always turn hood ON when cooking at high heat.
3. Use high range settings on range only when necessary. Heat oil slowly on low to medium setting.
4. Don't leave range unattended when cooking.
5. Always use cookware and utensils appropriate for the type and amount of food being prepared.

TO REDUCE THE RISK OF INJURY TO PERSONS IN THE EVENT OF A RANGE TOP GREASE FIRE, OBSERVE THE FOLLOWING:

1. **SMOTHER FLAMES** with a close-fitting lid, cookie sheet, or metal tray, then turn off the burner. **BE CAREFUL TO PREVENT BURNS.** If the flames do not go out immediately, **EVACUATE AND CALL THE FIRE DEPARTMENT.**
2. **NEVER PICK UP A FLAMING PAN** - You may be burned.
3. **DO NOT USE WATER**, including wet dishcloths or towels - a violent steam explosion will result.
4. Use an extinguisher **ONLY** if:
 - A. You know you have a Class ABC extinguisher and you already know how to operate it.
 - B. The fire is small and contained in the area where it started.
 - C. The fire department is being called.
 - D. You can fight the fire with your back to an exit.

* Based on "Kitchen Firesafety Tips" published by NFPA.

CAUTION

1. For general ventilating use only. Do not use to exhaust hazardous or explosive materials and vapors.
2. To avoid motor bearing damage and noisy and/or unbalanced impellers, keep drywall spray, construction dust, etc. off power unit.
3. This product is equipped with a thermostat which may start fan automatically. To reduce the risk of injury, switch power off at service panel and lock service panel to prevent power from being switched on accidentally.
4. Your hood motor has a thermal overload which will automatically shut off the motor if it becomes overheated. The motor will restart when it cools down. If the motor continues to shut off and restart, have the hood serviced.
5. For best capture of cooking impurities, your range hood should be mounted 18-24" above the cooking surface.
6. Please read specification label on product for further information and requirements.

WARRANTY

FULL THREE YEAR WARRANTY ON PARTS

If within 3 years from the date of installation, any part of this range hood fails to function properly due to a defect in material or workmanship, Sears will repair the part or furnish and install a new part, free of charge.

FULL 30-DAY WARRANTY ON FINISH ON PAINTED OR BRIGHT METAL PARTS

If within 30 days from the date of installation, the finish on any painted or bright metal parts of this range hood is defective in material or workmanship, Sears will furnish and install a new part, free of charge.

WARRANTY SERVICE IS AVAILABLE BY CONTACTING THE NEAREST SEARS SERVICE CENTER/DEPARTMENT IN THE UNITED STATES.

This warranty applies only while this product is in use in the United States. This warranty gives you specific legal rights and you may have other rights which vary from state to state.

Sears, Roebuck and Co., Dept 817WA, Hoffman Estates, IL 60179

OPERATING INSTRUCTIONS

Always turn your hood on before you begin cooking to establish air flow in the kitchen. Let the hood run for a few minutes clear the air after you turn the range off. This will help keep the whole kitchen cleaner and brighter.

CONTROLS (FIG. 1)

BLOWER — The blower has 7 speed ranges. Select the range which offers adequate exhaust for the amount and type of cooking being done.

LIGHT — Three light levels are available. Use LOW for a night-light. Use MED or HIGH when cooking.

AUTO TEMP — Your range hood has a unique feature which monitors the temperature inside the hood whenever a speed range has been selected. As the temperature increases, blower speed will increase within the selected speed range. The additional air flow will exhaust heat and cooking by-products more effectively. As the temperature drops, blower speed will decrease.

To manually increase or decrease the blower speed, simply select a higher or lower range.

An indicator lamp lights when the hood is in the AUTO TEMP mode.

HEAT SENTRY™ — Your range hood is equipped with a HEAT SENTRY™ feature. This safety device senses excess heat above the cooking surface and operates as follows:

- 1.) If blower is OFF - it turns blower ON to HIGH speed
- 2.) If blower is ON at a lower speed setting - it turns blower up to HIGH speed.

An indicator lamp lights when the hood is in the HEAT SENTRY™ mode.

When the temperature level drops to normal, the blower will return to its original setting.

HIGH HEAT ALARM — This special safety feature sounds a warning whenever an excessively high temperature is detected. It is active whether the blower is ON or OFF. The alarm is a pulsing, medium tone and resets automatically when the temperature drops.

TEST — Checks operation of Automatic Features:

Depress TEST - Auto Temp and Heat Sentry™ indicators will light, the blower will come ON to HIGH speed, and the High Heat alarm will sound.

Release TEST - Hood will return to normal operating mode. Note: If TEST is depressed when cooking temperature is elevated, some Automatic Features may remain ON after TEST is released. Hood will return to normal operating mode when cooking temperature decreases.

FIG. 1

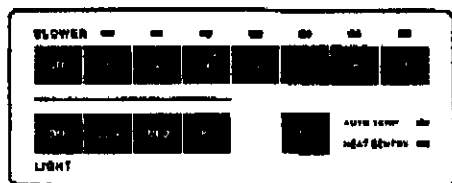

CARE AND MAINTENANCE

LIGHT BULB REPLACEMENT

Remove light lens by squeezing sides of lens toward center to release tabs. Install two 75 Watt max. bulbs, or one 75 Watt bulb in left-hand socket, and one 25 Watt bulb in right-hand socket, for night-light use. Do not use bulbs rated higher than 75 Watts.

FILTER CARE

Remove each filter by grasping the tab at the bottom of filter, lifting up and swinging filter out to the side.

ALUMINUM FILTERS — Clean filters frequently in a detergent solution. They are dishwasher safe.

DUCTFREE MICROTEK® FILTERS — The aluminum filter is the only washable part of the Microtek® System IV Filter. Snap it out of its frame and clean it in a detergent solution or dishwasher.

The particle filter is not washable. It should last up to twelve months with normal use.

CLEANING

Do not allow an excessive accumulation of grease. Use a mild detergent suitable for painted surfaces. DO NOT USE ABRASIVE CLOTH, STEEL WOOL PADS, OR SCOURING POWDERS. Vacuum blower to clean. Do not immerse blower in water.

BLOWER INSTALLATION AND REPLACEMENT (FIG. 2)

This hood is designed to be installed as either a vented or ventless hood. Follow the appropriate directions below for your installation.

1. Set hood upside down and remove bottom cover and screws.
2. Remove filters.
3. Remove wiring box cover and screws.
4. Remove light lens.
5. To make hood lighter and easier to handle, remove blower assembly. Do not grasp blower by the blower wheels.
 - a.) Unplug blower
 - b.) Loosen knurled nuts on mounting rods and swing rods out of the way. Do not remove nuts completely from rods.
 - c.) Lift out blower and set blower aside.

FIG. 2

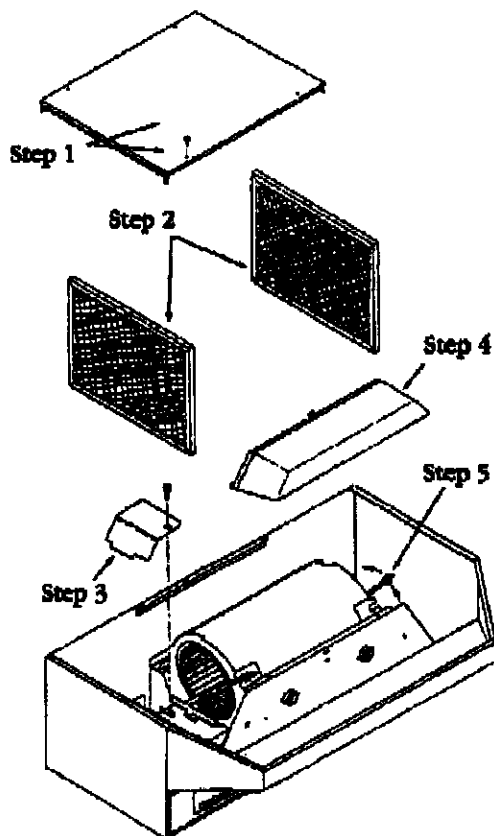

VERTICALLY VENTED INSTALLATIONS (FIG. 3)

Make sure that the blower discharge lines up with the duct opening in the top of the hood. Lift up the blower, slip the blower mounting rods into brackets on blower and tighten knurled nuts securely. Plug in blower.

FIG. 3

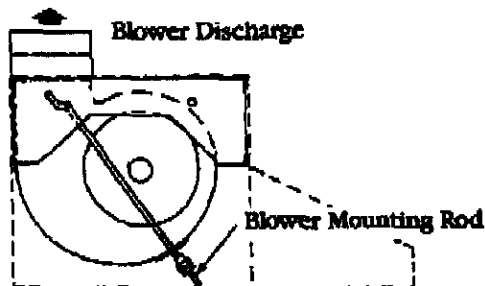

HORIZONTALLY VENTED INSTALLATIONS (FIG. 4)

Make sure that the blower discharge lines up with the duct opening in the back of the hood. Lift up the blower, slip the blower mounting rods into brackets on blower and tighten knurled nuts securely. Plug in blower.

FIG. 4

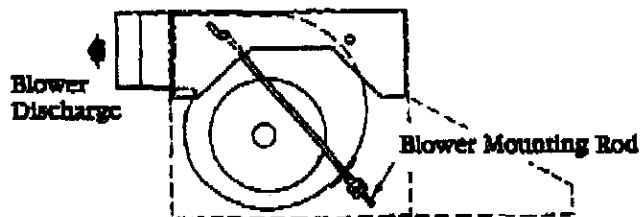

FILTER INSTALLATION - VENTED INSTALLATIONS (FIG. 5)

Push filters up into recess at top of hood. Swing filters in and pull down. Make sure that tab on filter is toward outside and bottom of hood.

FIG. 5

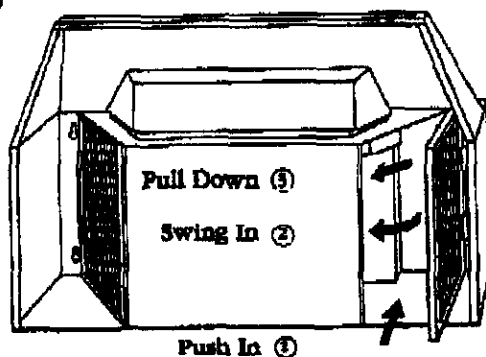

CONVERTING TO VENTLESS (FIG. 6 & FIG. 7)

Order a Ventless Filter Kit #50185 - Contains two (2) Clean Cooking System IV filters.

1. Remove louver cover. Pry off cover with screwdriver or knife (FIG. 6).

Note

Discard damper/duct connector, 1/4" black sheet metal screws, and louver cover.

FIG. 6

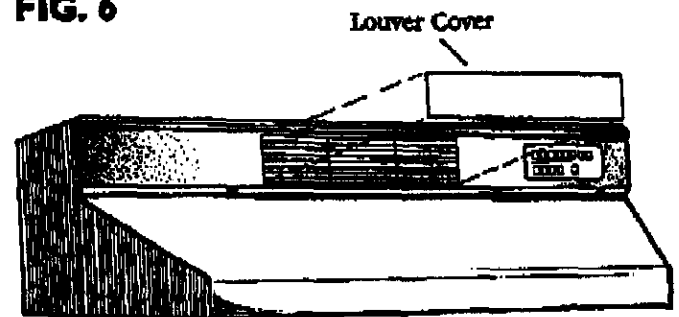

2. Install blower. Move blower mounting rods to front holes in hood support channels. Position blower so that blower lines up with louvered opening on hood front (FIG. 7).

FIG. 7

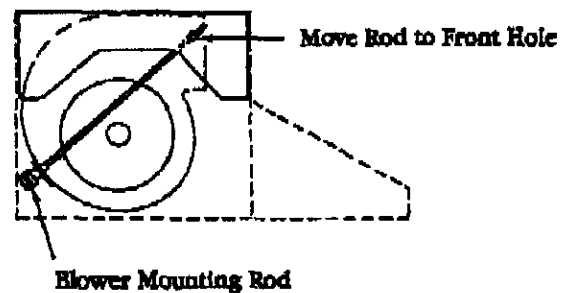

3. Slip blower mounting rods into brackets on blower and tighten knurled nuts securely.

FILTER INSTALLATION - VENTLESS INSTALLATIONS (FIG. 8)

aluminum filter provided with hood into front of Clean Cooking System IV filter. Make sure that tab on aluminum filter lines up with finger pull on Clean Cooking System IV filter. Push filter assemblies up into hood. Flaps on filter will flex against top sides of opening. Push assemblies up until bottom of assembly clears lip on bottom cover. Insert bottom of filter into opening and pull assembly down, collapsing finger pull against aluminum filter.

FIG. 8

Clean Cooking System IV Filter

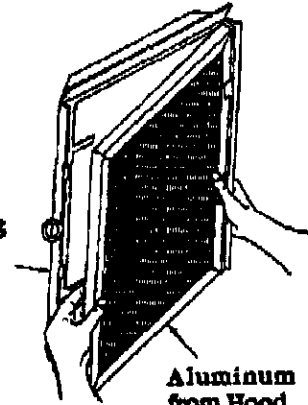

Aluminum Filter from Hood

Flexible Flap Springs Up for Air-Tight Seal

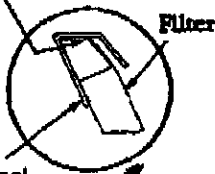

Filter Channel in Hood

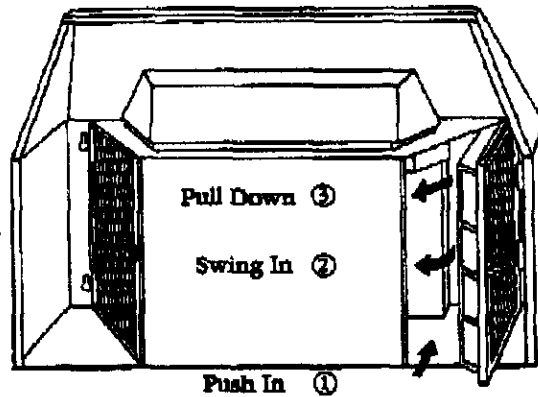

Flap Folds Down when Filter is Pushed into Hood

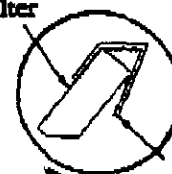

Filter Channel in Hood

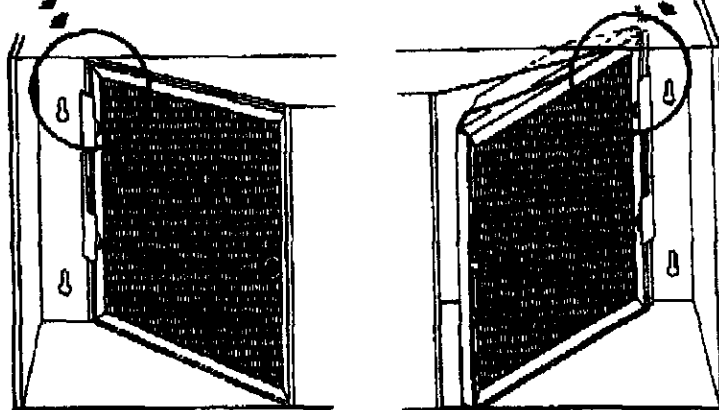

WIRING DIAGRAM

NOTE: If any of the original wire on the hood has to be replaced, use wire having equivalent insulation and temperature rating (105°C Thermoplastic AWM, U.L. Listed).

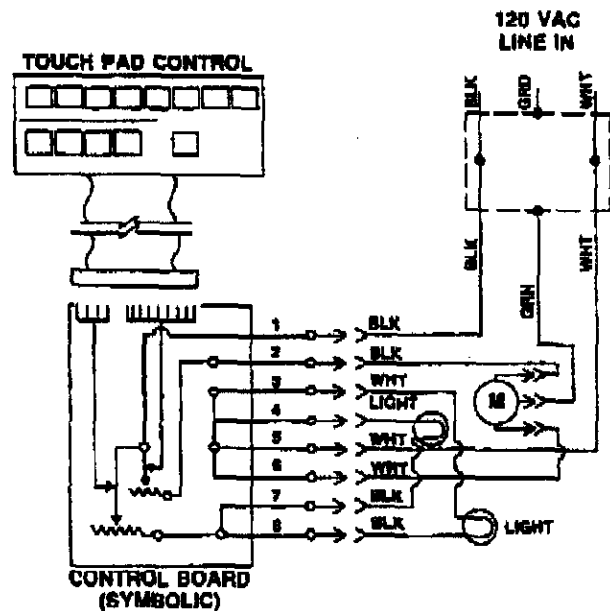

MODELS

233.55345590

233.55445590

233.55545590

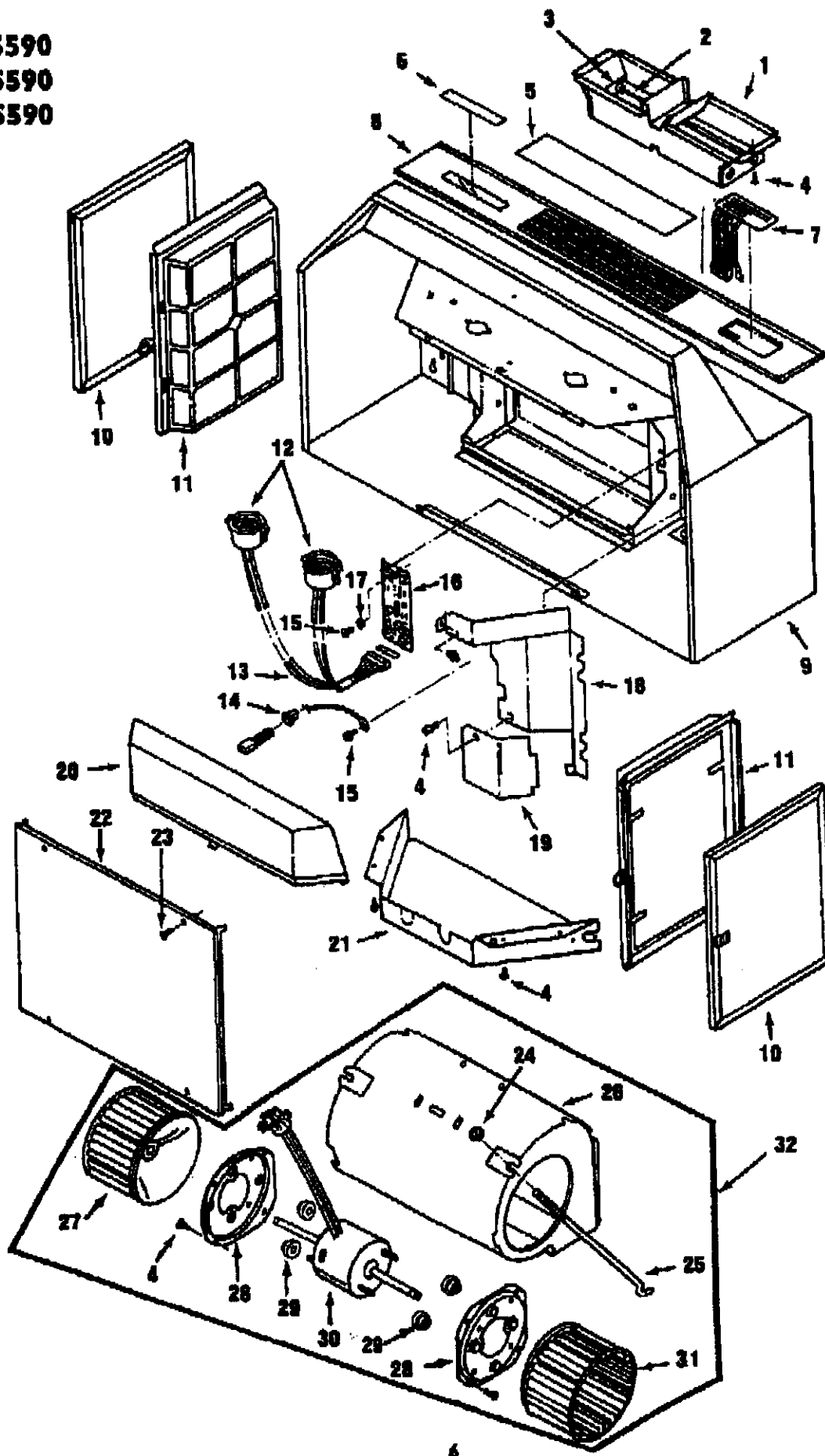

PARTS LIST

KEY NO.	PART NUMBER	DESCRIPTION
1	97008078	Damper Assembly (Includes Key Nos. 2 & 3)
2	98005221	Damper Flap
3	99100379	Damper Bushing (2 Required)
4	99170245	#8-18 x 3/8 Hex Head Sheet Metal Screws (18 Required)*
5	99110820	Louver Cover - Black
	99110847	Louver Cover - White
	99111038	Louver Cover - Almond
6	99090949	Kenmore Medallion - Black
	99090948	Kenmore Medallion - White
	99090950	Kenmore Medallion - Almond
7	99271119	Touch Pad Switch - Black
	99271118	Touch Pad Switch - White
	99271120	Touch Pad Switch - Almond
8	97012388	Control Panel Assembly - Black (30" Wide Hoods) (Includes Key No. 7)
	97012391	Control Panel Assembly - White (30" Wide Hoods) (Includes Key No. 7)
	97012394	Control Panel Assembly - Almond (30" Wide Hoods) (Includes Key No. 7)
	97012389	Control Panel Assembly - Black (36" Wide Hoods) (Includes Key No. 7)
	97012392	Control Panel Assembly - White (36" Wide Hoods) (Includes Key No. 7)
	97012395	Control Panel Assembly - Almond (36" Wide Hoods) (Includes Key No. 7)
	97012390	Control Panel Assembly - Black (42" Wide Hoods) (Includes Key No. 7)
	97012393	Control Panel Assembly - White (42" Wide Hoods) (Includes Key No. 7)
	97012396	Control Panel Assembly - Almond (42" Wide Hoods) (Includes Key No. 7)
9	97009092	Canopy - 30" White (233.55345590)
	97009093	Canopy - 30" Almond
	97010323	Canopy - 30" Stainless Steel
	97012938	Canopy - 30" Black
	97009094	Canopy - 36" White (233.55445590)
	97009095	Canopy - 36" Almond
	97010324	Canopy - 36" Stainless Steel
	97012939	Canopy - 36" Black
	97009096	Canopy - 42" White (233.55545590)
	97009097	Canopy - 42" Almond
	97010325	Canopy - 42" Stainless Steel
	97012940	Canopy - 42" Black
10	97007894	Aluminum Filter Kit (Contains 2 Filters)
11	97007998	Clean Cooking System IV Filter Kit (Contains 2 Filters)
12	99270754	Bulb Holder (2 Required)
13	97009091	Wire Harness with Lamp Holders
14	99400042	Strain Relief Bushing
15	99150471	#10-32 x 1/2 Green Ground Screw* (4 Required)
16	97010824	Control Board Assembly
17	99250945	Washer
18	97009089	Wiring Box Cover
19	98007237	Access Cover
20	99110805	Light Lens
21	98006546	Bulb Holder Cover
22	97007895	Bottom Cover - White
	97007899	Bottom Cover - Almond
	97007831	Bottom Cover - Stainless Steel
	97011974	Bottom Cover - Black
23	99150478	#8-18 x 3/8 Phillips Truss Head Screws (4 Required)*
24	99260476	Blower Mounting Rod Nut (2 Required)
25	99420464	Blower Mounting Rod (2 Required)
26	97007314	Blower Scroll Housing
27	99020138	Blower Wheel, Clockwise
28	99005212	Motor Retaining Ring (2 Required)
29	99100491	Rubber Motor Mount (4 Required)
30	97010736	Motor
31	99020139	Blower Wheel, Counterclockwise
32	97010327	Blower Assembly (Not Including Key Nos. 24 & 25)
**	99042171	Operating Instructions and Parts List
**	99042173	Installation Instructions
**		Light Bulb, 75 Watt Max. (2 Required) Not supplied with hood.

* Standard Hardware. May be purchased locally.

** Not Illustrated.