

**Use & Care Guide**  
**Manual de uso y cuidado**



Models/Modelos: 722.1467\*

# Kenmore Elite®

## Dishwasher

## Lavavajillas

\* = color number, número de color



MFL69706502

Sears Brands Management Corporation

Hoffman Estates, IL 60179 U.S.A.

[www.kenmore.com](http://www.kenmore.com)



---

# TABLE OF CONTENTS

<b>WARRANTY</b> .....	<b>3</b>
<b>DISHWASHER SAFETY</b> .....	<b>4</b>
<b>PARTS AND FEATURES</b> .....	<b>6</b>
Exterior Parts.....	6
Interior Parts.....	7
Product Specifications .....	7
<b>START-UP/QUICK REFERENCE</b> .....	<b>8</b>
<b>CLEANING THE FILTERS</b> .....	<b>9</b>
<b>DISHWASHER EFFICIENCY TIPS</b> .....	<b>10</b>
<b>DETERGENT AND RINSE AID</b> .....	<b>11</b>
Detergent.....	11
Rinse Aid.....	12
<b>LOADING</b> .....	<b>13</b>
Top Rack Loading.....	13
Bottom Rack Loading.....	14
Cutlery & Utensil Rack Loading .....	16
<b>DISHWASHER USE</b> .....	<b>17</b>
Cycles and Options Information .....	17
Dishwasher Control Section .....	19
Dishwasher Feedback Section.....	19
Canceling a Cycle .....	19
Changing a Cycle after Dishwasher Is Started.....	20
Adding a Dish after Dishwasher Is Started .....	20
<b>SMART FEATURES</b> .....	<b>21</b>
Overview .....	21
Getting Connected.....	21
Connecting the Dishwasher.....	21
My Cycle.....	21
FCC Notice.....	22
<b>WASHING SPECIAL ITEMS</b> .....	<b>23</b>
<b>DISHWASHER CARE</b> .....	<b>24</b>
Cleaning.....	24
Dishwasher Maintenance Procedure .....	24
Drain Air Gap.....	25
Vacation or Extended Time Without Use.....	25
<b>DIAGNOSTICS</b> .....	<b>26</b>
<b>TROUBLESHOOTING</b> .....	<b>27</b>
<b>SERVICE</b> .....	<b>Back Cover</b>

# KENMORE ELITE LIMITED WARRANTY

WITH PROOF OF SALE the following warranty coverage applies when this appliance is correctly installed, operated and maintained according to all supplied instructions. In all cases replacement units or parts are warranted only for the unexpired portion of the warranty period from the original date of sale.

FOR ONE YEAR from the date of sale this appliance is warranted against defects in material or workmanship. A defective appliance will receive free repair or replacement at option of seller.

FOR TWO YEARS from the date of sale all parts of this appliance are warranted against defects in material or workmanship. If a part is defective within the first year, a new part will be supplied and installed at no charge. If a part is defective after the first year, a new part will be supplied but not installed at no charge. You are responsible for the labor cost of part installation after the first year from the date of sale.

FOR FIVE YEARS from the date of sale, all parts of the upper or lower dish rack are warranted against rust due to defects in material or workmanship. If a rack part rusts from defects within the first year, a new part will be supplied and installed at no charge. If a rack part rusts from defects after the first year, a new part will be supplied but not installed at no charge. You are responsible for the labor cost of part installation after the first year from the date of sale.

FOR AS LONG AS IT IS USED from the date of sale, the stainless steel tub and inner door panel of this appliance are warranted against leaks due to rust-through. If a tub or panel rusts through within the first year, a new part will be supplied and installed at no charge. If a tub or panel rusts through after the first year, a new part will be supplied but not installed at no charge. You are responsible for the labor cost of part installation after the first year from the date of sale.

For warranty coverage details to obtain free repair or replacement, visit the web page: [www.kenmore.com/warranty](http://www.kenmore.com/warranty)

All warranty coverage applies for only 90 DAYS from the sale date if this appliance is ever used for other than private household purposes.

**This warranty covers ONLY defects in material and workmanship, and will NOT pay for:**

1. Expendable items that can wear out from normal use, including but not limited to filters, belts, bags or screw-in base light bulbs.
2. A service technician to clean or maintain this appliance, or to instruct the user in correct appliance installation, operation and maintenance.
3. Service calls to correct appliance installation not performed by Sears authorized service agents, or to repair problems with house fuses, circuit breakers, house wiring, and plumbing or gas supply systems resulting from such installation.
4. Damage to or failure of this appliance resulting from installation not performed by Sears authorized service agents, including installation that was not in accord with electrical, gas or plumbing codes.
5. Damage to or failure of this appliance, including

discoloration or surface rust, if it is not correctly operated and maintained according to all supplied instructions.

6. Damage to or failure of this appliance, including discoloration or surface rust, resulting from accident, alteration, abuse, misuse or use for other than its intended purpose.
7. Damage to or failure of this appliance, including discoloration or surface rust, caused by the use of detergents, cleaners, chemicals or utensils other than those recommended in all instructions supplied with the product.
8. Damage to or failure of parts or systems resulting from unauthorized modifications made to this appliance.
9. Service to an appliance if the model and serial plate is missing, altered, or cannot easily be determined to have the appropriate certification logo.

## **Disclaimer of implied warranties; limitation of remedies**

Customer's sole and exclusive remedy under this limited warranty shall be product repair or replacement as provided herein. Implied warranties, including warranties of merchantability or fitness for a particular purpose, are limited to one year on the appliance, two years on appliance parts, five years on dish racks, and for as long as used on the tub and inner door panel, or the shortest period allowed by law. Seller shall not be liable for incidental or consequential damages. Some states and provinces do not allow the exclusion or limitation of incidental or consequential damages, or limitation on the duration of implied warranties of merchantability or fitness, so these exclusions or limitations may not apply to you.

This warranty applies only while this appliance is used in the United States.

This warranty gives you specific legal rights, and you may also have other rights which vary from state to state.

**Sears Brands Management Corporation  
Hoffman Estates, IL 60179**

# DISHWASHER SAFETY

## Your safety and the safety of others are very important.

We have provided many important safety messages in this manual and on your appliance. Always read and obey all safety messages.



This is the safety alert symbol.

This symbol alerts you to potential hazards that can kill or hurt you and others.

All safety messages will follow the safety alert symbol and either the word "WARNING" or "CAUTION." These words mean:

**⚠ WARNING**

**You can be killed or seriously injured if you don't follow instructions.**

**⚠ CAUTION**

**Failure to follow instructions may result in minor or moderate injury or product damage.**

All safety messages will tell you what the potential hazard is, tell you how to reduce the chance of injury, and tell you what can happen if the instructions are not followed.

## IMPORTANT SAFETY INSTRUCTIONS

**WARNING:** When using the dishwasher, follow basic precautions, including the following:

- Read all instructions before using the dishwasher.
- Use the dishwasher only for its intended function.
- Use only detergents or rinse agents recommended for use in a dishwasher, and keep them out of the reach of children.
- When loading items to be washed:
  - 1) Locate sharp items so that they are not likely to damage the door seal; and
  - 2) Load sharp knives with the handles up to reduce the risk of cuts.
- Do not wash plastic items unless they are marked "dishwasher safe" or the equivalent. For plastic items not so marked, check the manufacturer's recommendations.
- Do not touch the heating element during or immediately after use.
- Do not operate the dishwasher unless all enclosure panels are properly in place.
- Do not tamper with controls.
- Do not abuse, sit on, or stand on the door, lid, or dish racks of the dishwasher.
- To reduce the risk of injury, do not allow children to play in or on the dishwasher.
- Under certain conditions, hydrogen gas may be produced in a hot water system that has not been used for two weeks or more. **HYDROGEN GAS IS EXPLOSIVE.** If the hot water system has not been used for such a period, before using the dishwasher turn on all hot water faucets and let the water flow from each for several minutes. This will release any accumulated hydrogen gas. As the gas is flammable, do not smoke or use an open flame during this time.
- Remove the door or lid to the washing compartment when removing an old dishwasher from service or discarding it.

## SAVE THESE INSTRUCTIONS

### California Proposition 65

This product contains chemicals known to the State of California to cause cancer and birth defects or other reproductive harm. **Wash hands after handling.** (USA only)

## **! WARNING**

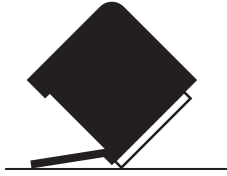

### **Tip Over Hazard**

**Do not use dishwasher until completely installed.  
Do not push down on open door.  
Doing so can result in serious injury or cuts.**

## **! WARNING**



### **Electrical Shock Hazard**

**Electrically ground dishwasher.  
Connect ground wire to green ground connector  
in terminal box.  
Do not use an extension cord.  
Failure to follow these instructions can result in  
death, fire, or electrical shock.**

## **GROUNDING INSTRUCTIONS**

- **For a grounded, cord-connected dishwasher:**  
The dishwasher must be grounded. In the event of a malfunction or breakdown, grounding will reduce the risk of electric shock by providing a path of least resistance for electric current. If the dishwasher is equipped with a cord having an equipment-grounding conductor and a grounding plug, the plug must be plugged into an appropriate outlet that is installed and grounded in accordance with all local codes and ordinances.  
**WARNING:** Improper connection of the equipment-grounding conductor can result in a risk of electric shock. Check with a qualified electrician or service representative if you are in doubt whether the dishwasher is properly grounded. Do not modify the plug if it will not fit the outlet, have a proper outlet installed by a qualified electrician.
- **For a permanently connected dishwasher:**  
The dishwasher must be connected to a grounded metal, permanent wiring system, or an equipment-grounding conductor must be run with the circuit conductors and connected to the equipment-grounding terminal or lead on the dishwasher.

## **SAVE THESE INSTRUCTIONS**

- Install where dishwasher is sheltered from the elements. Avoid possible rupture of fill valve from freezing. Such ruptures are not covered by the warranty. See the "Vacation or Extended Time Without Use" section.
- Install and level dishwasher on a floor that will hold the weight and in an area suitable for its size and use.
- Remove all shipping plugs from hoses and connectors (such as the cap on the drain outlet) before installing. See Installation Instructions for complete information.

# PARTS AND FEATURES

## Exterior Parts

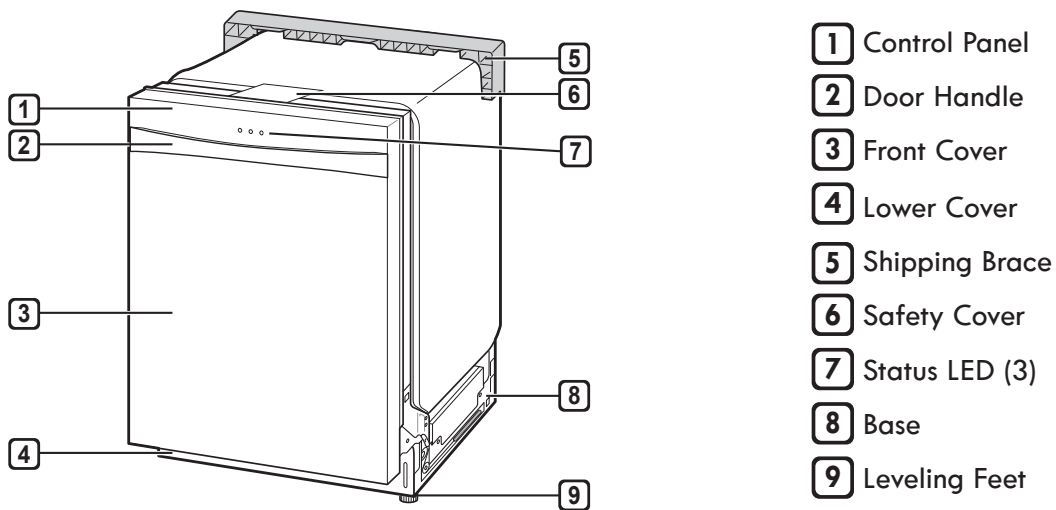

**NOTE:** Do not remove the safety cover at any time.

### Status LED

- Red : Error (See the Error Codes in Troubleshooting section.)
- White (steady): Normal operation
- White (blinking): Cycle has been paused. (After four minutes in pause mode, the machine turns off.)
- Green: Cycle finished normally.

The green light stays on for 90 seconds.

To keep the green light on until the door is opened, turn the power on, and then press and hold Hi Temp Wash on the control panel for three seconds until OFF or On appears in the display. The dishwasher remembers this setting until manually changed.

## Interior Parts

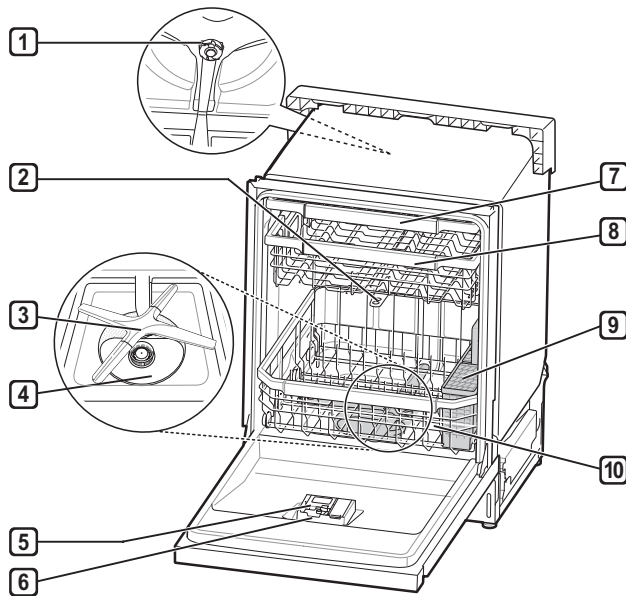

- 1** Top Spray Arm
- 2** Upper Spray Arm
- 3** Lower Spray Arm
- 4** Filtration System
- 5** Detergent and Rinse Aid Dispenser
- 6** Drying Vent Cover
- 7** Cutlery & Utensil Rack
- 8** Top Rack
- 9** Silverware Basket
- 10** Bottom Rack

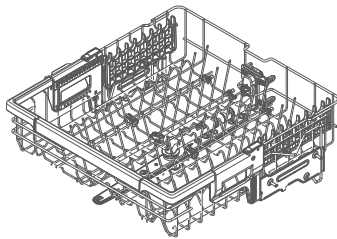

Top Rack

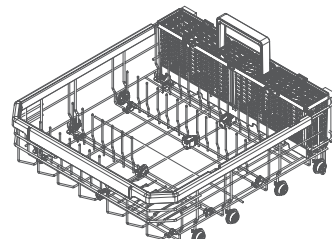

Bottom Rack

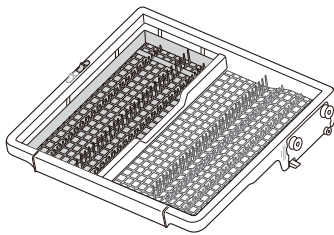

Cutlery & Utensil Rack

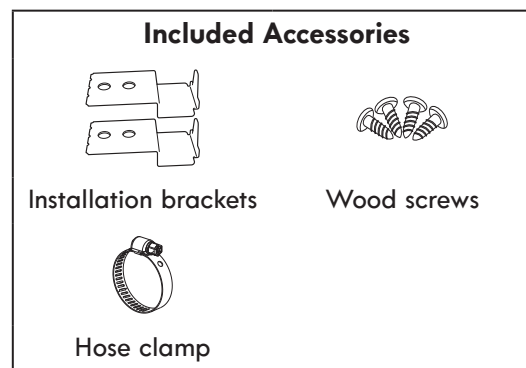

## Product Specifications

The appearance and specifications listed in this manual may vary due to constant product improvements.

<b>Electrical requirement</b>	120 V, 60 Hz AC only, minimum 15 A circuit breaker
<b>Water pressure</b>	20 - 80 psi (140 - 550 kPa)
<b>Dimensions</b>	23 3/4"(W) X 26 3/4"(D) X 33 5/8"(H) 603 mm(W) X 679 mm(D) X 854 mm(H)
<b>Inlet water temperature</b>	120 °F (49 °C) minimum
<b>Net weight</b>	81.5 lbs. (39.6 kg)

# START-UP/QUICK REFERENCE

## Filters Provide Peak Performance

Cleaning the filters periodically helps keep the dishwasher working at peak performance. The filters can be found at the bottom center of your dishwasher.

See [Cleaning the Filters](#) for information on removing and maintaining the filters.



## Drying - Rinse Aid Is Essential

You must use a drying agent such as rinse aid for good drying performance (sample included). Rinse aid along with the Extra Dry option will provide best drying and avoid excessive moisture in the dishwasher interior.

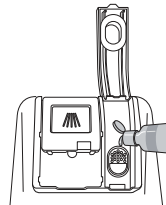

...  
Extra  
Dry

## Express Wash - When You Need Fast Results

High Efficiency dishwashers run longer to save water and energy just as driving a car slower saves on gas. When you need fast results, the Express Wash cycle will clean your dishes using slightly more water and energy. For improved drying, select the Extra Dry option to add additional time to dry.

...  
Express  
Wash

## Smart Wash Cycle

Smart Wash provides improved results using only the amount of water and energy needed. The Smart Wash and Pots & Pans cycles are recommended for tough soil.

...  
Smart  
Wash

## Adding Dishes

The dishwasher will start automatically, after a slight delay, when the door is closed and latched. During the cycle, the display will indicate the estimated time remaining for the cycle and options selected. If the door is opened during the cycle, the dishwasher will stop. When the door is closed, the cycle will resume from the point where it was stopped.

## Measuring Detergent

It is possible to use too much detergent in your dishwasher. This can lead to etching of your dishes. See “Detergent and Rinse Aid” to determine the amount of detergent needed based on your water hardness. High quality dishwasher detergent tablets or packs have been proven to be better than powdered, liquid, or gel detergents at reducing filming on dishes.

# CLEANING THE FILTERS

This dishwasher has the latest technology in dishwasher filtration. This filtration system minimizes sound and optimizes water and energy consumption while providing superior cleaning performance. Maintain the filter regularly to ensure peak cleaning performance throughout the life of the dishwasher.

- The assembled inner filter keeps oversized items and foreign objects, along with very fine food particles, out of the pump.
- The stainless steel filter keeps food from being recirculated onto your dishware.

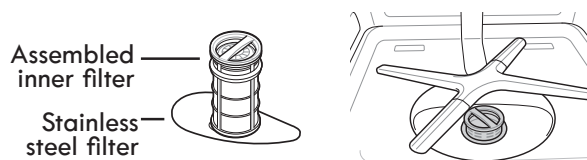

Remove, inspect, and clean the filter system once a month for best performance. Filters may need to be cleaned more often depending on usage. See chart below for details.

The filters may need to be cleaned when:

- Visible objects or soils are on the filter assembly.
- There is degradation in cleaning performance (that is, soils still present on dishes).
- Dishes feel gritty to the touch.

Removing and maintaining the filters is very easy. The chart below shows the recommended cleaning frequency.

## Recommended Filter Cleaning Schedule

Number of Loads Per Week	If you wash dishes before loading	If you scrape and rinse dishes before loading	If you only scrape dishes before loading*	If you do not scrape or rinse dishes before loading
1-3	Every 6 months	Once a year	Four times a year	Once a month
4-7	Every 6 months	Once a year	Four times a year	Twice a month (every 15 days)
8-12	Every 6 months	Every 6 months	Every 1.5 months	Every week
13-14	Every 6 months	Every 6 months	Every 1.5 months	Twice a week

\* Recommended: Only scraping dishes before loading them saves water, energy, and personal time and effort.

## Very Hard Water

If you have hard water (above 15 grains), clean the filter at least once per month. Buildup of white residue on dishwasher surfaces indicates hard water. For tips on removing spots and stains, see Troubleshooting section.

## Filter Removal Instructions

1. Turn the filter assembly counterclockwise and lift out.
2. Grasp the stainless steel filter in the circular opening, lift slightly, and pull forward to remove.
3. Clean the filters as shown in the Cleaning Instructions.

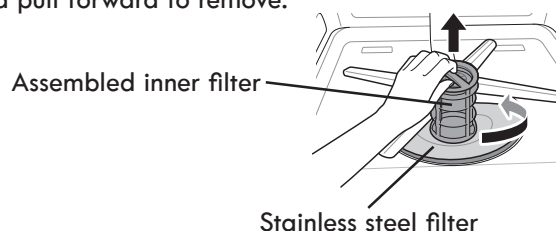

---

## Cleaning Instructions

**IMPORTANT:** Clean the filters with a soft brush under running water.  
Rinse filter under running water until most soils are removed.  
A soft brush may be required to get off hard to remove soil.

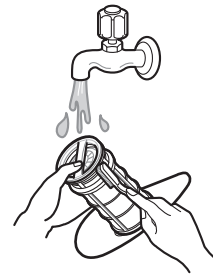

## Filter Reinstallation Instructions

1. To replace the assembled filters, position the spray arm so the wider vee is toward the front.
2. Fit the filters back into the filter holder and secure them by turning the inner filter clockwise until it clicks into place.

### NOTE:

- For best wash performance, clean the filter after each load. If food debris remains in the filter, it may cause an odor.
- In areas with hard water, clean the filter at least once a month with a soft brush.
- Clean the filters using non-abrasive materials and warm running water.
- Make sure the filter is assembled correctly before starting a cycle. When assembling, rotate it firmly until it clicks.

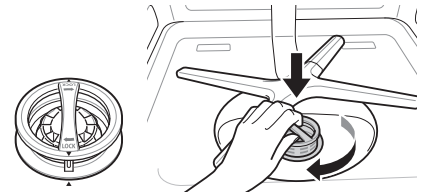

**⚠ WARNING:** Be cautious of sharp edges when handling the stainless steel filter.

**⚠ CAUTION:** Remove food residue caught in filters to prevent the build up of odor-causing bacteria and possible drainage problems.

---

# DISHWASHER EFFICIENCY TIPS

Hot water dissolves and activates the dishwasher detergent. Hot water also dissolves grease on dishes and helps glasses dry spot-free. For best results, water should be 120°F (49°C) as it enters the dishwasher. Loads may not wash as well if the water temperature is too low.

- To save water, energy and time, only scrape dishes. Do not rinse dishes before putting them into the dishwasher.
- Use a delay feature to run the dishwasher during off-peak hours. Contact your local utility for information on peak usage times, and avoid running the dishwasher during those times.
- During the summer, run your dishwasher at night. This reduces daytime heat buildup in the kitchen.
- Use a rinse aid to improve drying.

# DETERGENT AND RINSE AID

## Detergent

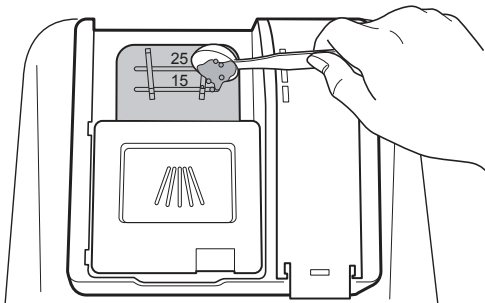

Add dishwashing detergent to the main wash compartment until the level is between the lines marked 15 and 25.

- Fill to over the 25 line for hard water or heavily soiled loads.
- Fill to the 15 line for soft water or lightly soiled loads.

**NOTE:** Do not use detergent if running a rinse cycle.

- Use automatic dishwasher detergent only. Add powdered, liquid or tablet detergent just before starting a cycle.
- Fresh automatic dishwasher detergent results in better cleaning. Store tightly closed detergent container in a cool, dry place.

### Premeasured Detergents

Many detergents now come in premeasured forms (gel packs, tablets, or powder packs). These forms are suitable for all hardness and soil levels. Always place premeasured detergents in main compartment of the dispenser and slide lid to close.

#### To close lid

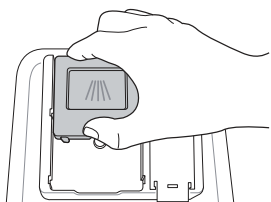

Place selected detergent in the dispenser. Push the detergent lid to slide the lid closed until it clicks.

#### To open lid

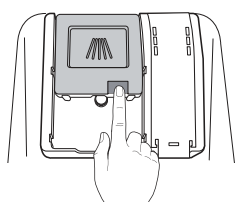

Push the button on the dispenser lid to open the lid cover.

High quality dishwasher detergent tablets or packs have been proven to be better than powdered, liquid, or gel detergents at reducing filming on dishes. Use of tablets and packs will start to reduce or eliminate white film on dishes over time. The rinse aid contained in the tablets or packs also minimizes buildup of film caused by excess detergent.

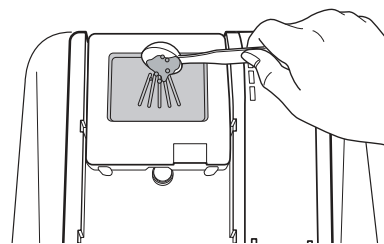

If a prewash is desired, fill the recessed prewash compartment area on the lid with detergent.

**IMPORTANT:** Extremely hard water mineral deposits (15 grains per U.S. gallon or more) can cause damage to your dishwasher and make it difficult to achieve good results. A water softener is recommended to avoid damage and achieve good results.

**NOTE:** Follow instructions on the package when using other dishwasher detergent types.

**WARNING:** Dishwasher detergent and rinse aid contain chemical components, like all other household detergent. So, they must be kept out of the reach of children.

### CAUTION:

- Use only detergent intended for dishwashers. Incorrect detergent may cause the dishwasher to fill with suds during operation. Excess suds may reduce wash performance and may cause the dishwasher to leak.
- To avoid damaging the dispenser, do not pull up on the dispenser to close the dishwasher door.

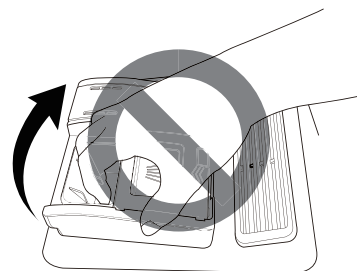

---

## Rinse Aid

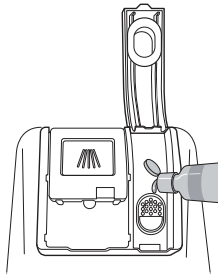

**IMPORTANT:** The dishwasher is designed to use rinse aid. The use of rinse aids greatly improves drying by allowing water to drain from the dishes after the final rinse. Rinse aids also keep water from forming droplets that can dry as spots or streaks.

### Adding Rinse Aid

How often the dispenser needs to be refilled depends on how often dishes are washed and the rinse aid setting used.

The **Rinse Aid** ( RINSE  
AID ) icon flashes when more rinse aid is needed, unless the rinse aid dispenser setting is set to L0.

1. To add rinse aid, open the rinse aid lid by lifting up the flap.
2. Add a liquid rinse aid to the maximum fill level. Do not overfill the rinse aid dispenser.
3. Clean up any spilled rinse aid. Spilled rinse aid can create excessive suds.
4. Close the lid to lock the dispenser. Rinse aid is dispensed automatically during the final rinse cycle.

**NOTE:** Only use liquid rinse aid in the dishwasher.

### Rinse Aid Dispenser Adjustment

The dispenser has five adjustment levels. The dishwasher is programmed at the factory for a rinse aid dispenser level of 2. This can be checked and altered by using the buttons on the control panel.

1. Ensure the appliance is off.
2. Press Mixed Load and Power simultaneously to check the current setting.
3. Press Delay Hours to change the rinse aid dispenser setting. Each press of the button changes the setting one step from L0 to L4.
4. Once the desired rinse aid dispenser setting is selected, press Start to save.

### NOTE:

- Adjust the setting higher if you have hard water and notice calcium buildup on your dishes.
- Setting the rinse aid control too low will contribute to spotting and streaking on dishes and poor drying performance.
- Setting the control too high can cause foaming, which will cause poor wash performance.

# LOADING

## Top Rack Loading

### Loading Recommendations

Place cups and glasses in the rows between tines. Placing them over the tines can lead to breakage and water spots. To avoid damage to your delicate items, be sure china, crystal, stemware and other similar items do not touch during dishwasher operation.

Load lightweight and dishwasher-safe plastic items only in the top rack.

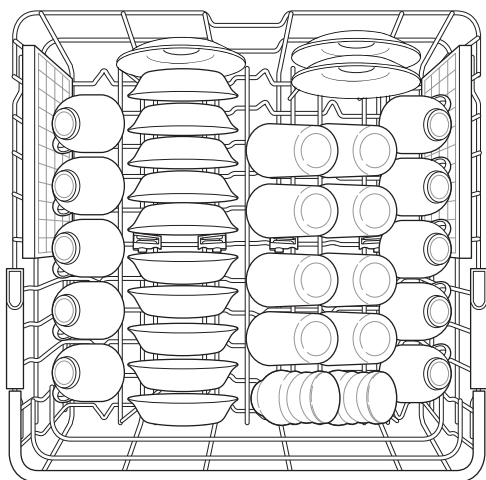

10 place setting load

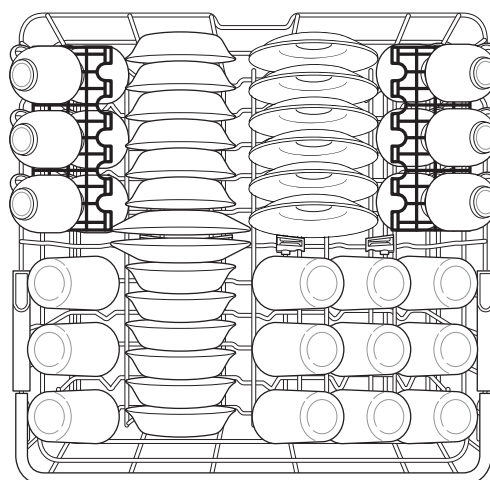

12 place setting load

### Height Adjustable Top Rack

The top rack adjusts up and down. Raise the top rack to allow items up to 14" tall in the bottom rack. Lower the top rack to allow dishes up to 12" tall in the top rack. The dishwasher ships with the top rack raised. There are three available positions for adjusting the height of the top rack to create more space.

1. To raise, lift the rack at the center of each side until the rack locks into place in the upper position. It is not necessary to lift the lock levers to raise the rack.
2. To lower, hold the rack at the center of each side to support its weight. Lift the lock levers on each side to release the rack and lower it until it locks into place.

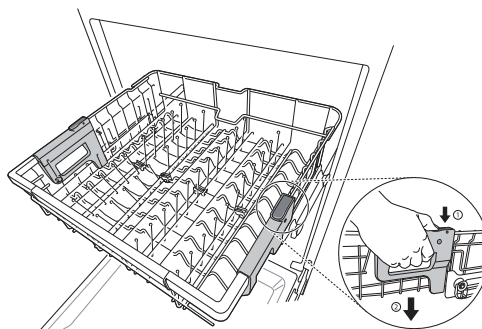

### Fold-Down Tines

Fold tines down to fit larger dishes; pull tines back up to fit smaller dishes.

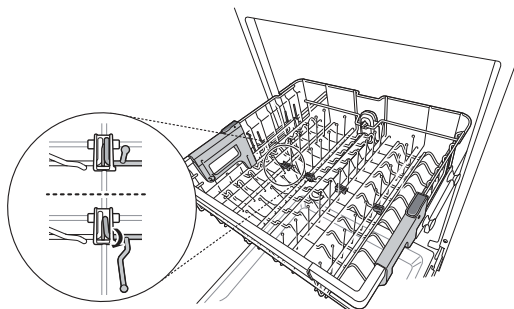

## Bottom Rack Loading

### Loading Recommendations

The bottom rack is best suited for plates, pans, casseroles, and utensils. See recommended loading patterns shown.

Load small items in the bottom rack only if they are secured in place.

Load plates, soup bowls, etc., between tines.

Load bowls securely between the rows of tines. Ensure that there is space between dishes so that the spray will reach all surfaces.

Load heavily soiled items facing the spray.

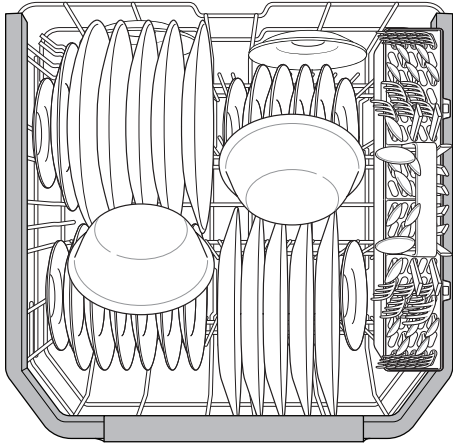

10 place setting load

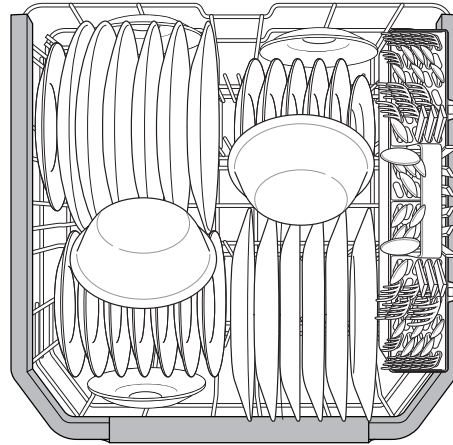

12 place setting load

### Fold-Down Tines

The tines are adjustable to fit dishes of various sizes.

#### Option 1

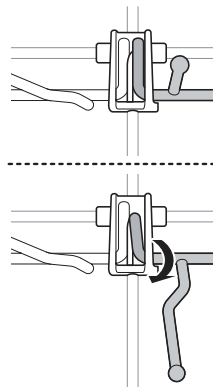

#### Option 2

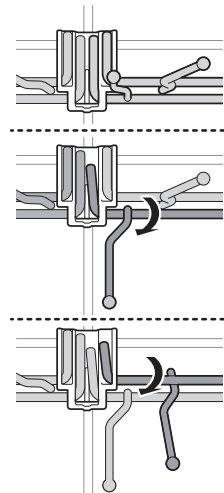

## Silverware Basket

The silverware basket has separators to avoid scratching and tarnishing of delicate silverware.

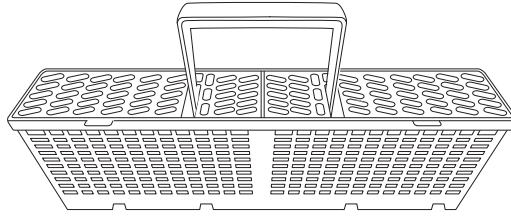

## Loading Silverware

For best cleaning results, use the top separators in the basket when loading silverware. The separators will prevent nesting of silverware.

Load sharp items, such as knives, pointing down.

When unloading the dishwasher, it is best to start with the silverware basket. Doing so will prevent water droplets from falling on your silverware from the upper rack.

10 place settings

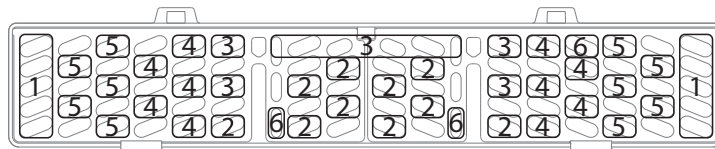

12 place settings

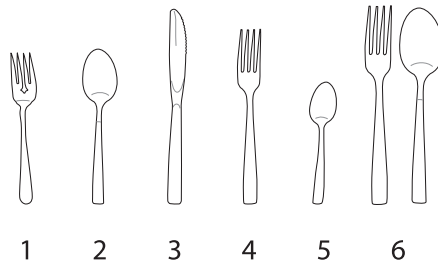
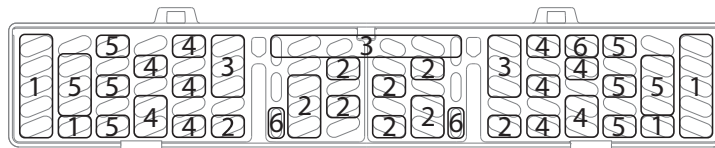

## Cutlery & Utensil Rack Loading

### Loading Recommendations

The cutlery and utensil rack is best suited for flatware and most cooking or serving utensils. It can also fit small prep bowls and lids. The separators on the cutlery and utensil racks help keep flatware separated to avoid damage and improve cleaning.

**NOTE:** For best cleaning performance, place flatware in the silverware baskets. Heavily soiled utensils or items with baked on foods should be placed in the middle rack or spoon basket for best performance.

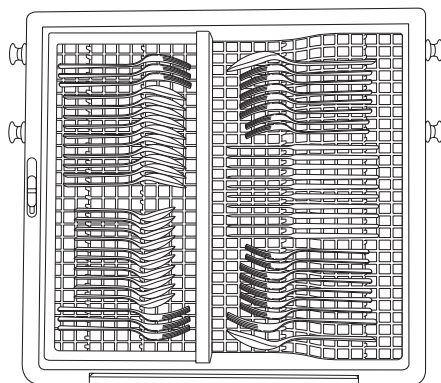

If the handles of your flatware are too thick, then reverse the pieces so that the handles face the other direction.

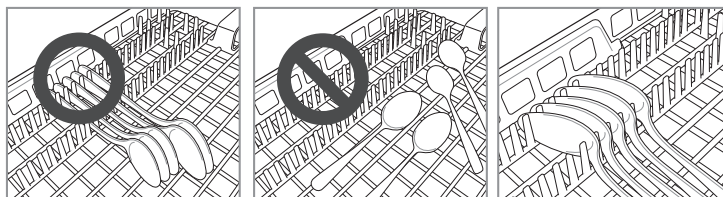

### Height Adjustable Tray

The tray on the left side can be adjusted to a high or low position to accommodate utensils or cutlery of different sizes. Remove dishes before adjusting the tray. Adjust the tray by sliding the lever.

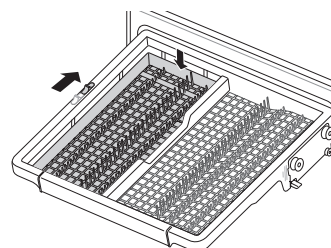

### Removing the Cutlery and Utensil Rack

The entire cutlery and utensil rack can be removed if more space is needed in the upper rack for larger items.

**NOTE:** Always remove the cutlery from the rack before removing the rack.

Pull the rack out to the end of the rails. Then, lift the front of the rack so that the rollers clear the stop on the end of the rail. The rack can now be slid forward and removed from the rails.

**WARNING:** Be careful when loading and unloading items with sharp edges. Load sharp knives with the blade down to reduce the risk of injury.

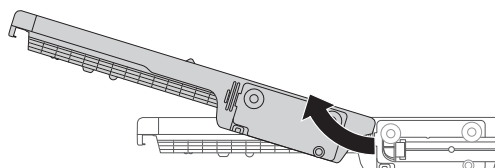

# DISHWASHER USE

## Cycles and Options Information



Cycles	Estimated Time* Displayed: H:MM	Range of Water Usage Gallons (Liters)
<p><b>Smart Wash</b> The most advanced and versatile cycle. This cycle senses the soil amount and toughness of soil. This cycle is optimized to achieve outstanding cleaning with minimal water and energy.</p>	1:58 - 3:00	3.4-5.3 (13.1-20.1)
<p><b>Pots &amp; Pans</b> Works best on your toughest items, such as casseroles with baked-on food residue.</p>	2:19 - 3:34	7.1 (26.9)
<p><b>China Gentle</b> Provides a light wash and gentle dry for delicate items such as china and crystal.</p>	1:35 - 2:13	5.2 (19.7)
<p><b>Normal Wash</b> This cycle with only the Extra Dry option selected, and without other options selected, is recommended to completely wash and dry a full load of normally soiled dishes. The energy usage label is based on this cycle and option combination.</p>	2:03 - 3:10	2.4-5.2 (9.2-19.5)
<p><b>Express Wash</b> To save water and energy, high efficiency dishwashers use advanced filtration which may result in longer cycle times (in some cases over 2 hours). When you need fast results, the Express Wash cycle will clean your dishes using slightly more water and energy. Then, towel dry dishes for immediate use. Select Extra Dry if you want to add a drying option.</p>	0:59 - 2:01	7.3 (27.5)
<p><b>Clean Dishwasher</b> This cycle is for cleaning the inside of the dishwasher. Use the cycle without dishes in the machine. It eliminates residual soils, odor, white spots, and other dirt. Add citric acid or another cleaning agent for more effective results. Press and hold Pots &amp; Pans for three seconds to activate.</p>	1:22	3.2 (12.3)
<p><b>Quick Rinse</b> This cycle is a quick rinse for dishes that will not be washed immediately. The cycle rinses dishes that have excess soil to soften dried on residue. Rinsing the dishes helps prevent odors in the dishwasher. No detergent should be used. This cycle does not have drying. Press and hold Normal Wash for three seconds to activate.</p>	0:12	1.8 (6.8)
<p><b>Quick Wash</b> This cycle will quickly clean lightly soiled dishes. This cycle does not have drying. Select the Extra Dry and Condensation Guard option or another cycle for better drying. Press and hold Express Wash for three seconds to activate.</p>	0:33-1:43	5.4 (20.4)

\*This is the approximate cycle time obtained with 120°F (49°C) hot water available at the dishwasher. A lower incoming water temperature will increase cycle times.

Options	Can be selected with
<p><b>Mixed Load</b> This option automatically sets the spray intensity to soft for the upper spray arm and strong for the lower spray arm. Place heavily soiled dishes like plates and bowls in the lower rack and lightly soiled dishes like cups and small plates in the upper rack to get the best results.</p>	<p>Smart Wash Pots &amp; Pans Normal Wash Express Wash Quick Wash</p>
<p><b>Half Rack</b> For small loads, use just the top or bottom rack to save energy. Each press of the Half Rack button cycles between the top rack only and the bottom rack only. Middle / Bottom</p>	<p>Smart Wash Pots &amp; Pans China Gentle Normal Wash</p>
<p><b>Eco Wash</b> The Eco Wash option saves energy by using less water. This option should only be used with light to medium soiled dishes.</p>	<p>Smart Wash China Gentle Normal Wash</p>
<p><b>Hi Temp Wash</b> Raises the main wash temperature to improve cleaning.</p>	<p>Smart Wash Pots &amp; Pans Normal Wash Express Wash Quick Wash</p>
<p><b>Extra Dry</b> Select the Extra Dry option for better drying performance. This option adds 60 minutes of extra drying time to the cycle.</p>	<p>Smart Wash Pots &amp; Pans China Gentle Normal Wash Express Wash Quick Wash</p>
<p><b>Condensation Guard</b> Dishes are often left in the dishwasher overnight after the cycle ends. This can result in the steam inside the tub condensing on dishes, leaving them wet. The Condensation Guard option runs the ventilation fan periodically to help vent the steam from the tub. Press and hold Extra Dry for three seconds to activate.</p>	<p>Smart Wash Pots &amp; Pans China Gentle Normal Wash Express Wash Quick Wash</p>

**NOTE:** Eco Wash cannot be used at the same time as Extra Dry or High Temp Wash.

## Dishwasher Control Section

### Delay Hours

Use this option to run the dishwasher during off-peak hours. Contact your local utility provider to determine off-peak hours.

### Delaying the Start Time

1. Select a wash cycle and options.
2. Press Delay Hours to choose the number of hours to be delayed.

**NOTE:** The delay time can be set from 1 to 12 hours, in one-hour increments.

### Control Lock Option

The Control Lock feature helps prevent settings from being changed during a cycle. Selecting this feature locks all of the buttons, except for the Power button, on the control panel. This feature does not lock the door.

### Activating the Control Lock:

Press and hold Half Rack and Eco Wash for three seconds. CL appears in the display once the Control Lock is activated. Repeat to deactivate.

**NOTE:** The dishwasher cannot start if the control is locked.

## Dishwasher Feedback Section

### Cycle Indicators and Time Display

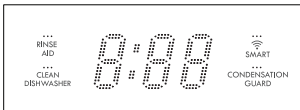

The indicators glow when the dishwasher is washing, drying, sanitizing, and at cycle completion.

They also glow when the control is locked and/or the delay option is selected.

The Status Display is used to follow the progress of the dishwasher cycle and to show other information.

Estimated cycle time is displayed in hours and minutes as you make cycle and option selections.

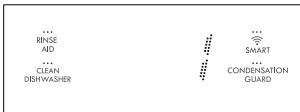

After you start the dishwasher, the display counts down the time.

When you select the Delay Hours option, the time display shows the delay time.

### Selecting Cycles and Options

Select the cycle and options that best fit the load by referring to the Cycles and Options Information .

### Turning OFF/ON the Button and End of Cycle Chimes

Press and hold Mixed Load and Eco Wash for three seconds to toggle sound On and Off.

## Canceling a Cycle

1. Open the door slightly to stop the cycle. Wait for the spraying action to stop before completely opening the door.
2. Press and hold Start for three seconds. The drain pump activates and the cycle cancels.
3. Once the dishwasher finishes draining, the power turns off.

**NOTE:** If the dishwasher is powered on and no cycle is selected for four minutes, the dishwasher powers off.

---

## Changing a Cycle after Dishwasher Is Started

You can interrupt a cycle and restart your dishwasher from the beginning using the following procedure.

1. Open the door slightly to stop the cycle. Wait for the spraying action to stop, then open the door completely.
2. Press and hold Start for three seconds.
3. Add the detergent to the dispenser.
4. Select new cycles and options.
5. Press Start and close the door.

---

## Adding a Dish after Dishwasher Is Started

1. Open the door slightly to stop the cycle. Wait for the spraying action to stop, then open the door completely.
2. Add items to the load.
3. Press Start and close the door.

---

# SMART FEATURES

---

## OVERVIEW

Kenmore Smart connectivity transforms your relationship with your home. You can personalize the way Kenmore Smart products operate based on your schedule and daily routines, making life easier and providing greater peace of mind. It does this by letting you link with and manage your Kenmore Smart products on one app, all from trusted brands, from a smart phone, tablet or computer.

This appliance is a connected-ready appliance, allowing you to remotely monitor and control it from your smart phone via the Kenmore® Smart app.

To get started, you will need the following:

- Kenmore Elite® Smart Appliance
  - WI-FI home router connected to the internet
  - Smart phone
  - Kenmore Smart app
- 

## GETTING CONNECTED

You need the following devices and application to use the My Cycle and other smart features on your dishwasher.

Required Devices: A wireless router, Kenmore Elite Smart Dishwasher, and a mobile device.

Required Application: Kenmore Smart App.

---

## CONNECTING THE DISHWASHER

Refer to the Quick Start Guide that came with your smart appliance for detailed instructions on creating a Kenmore account and setting up the appliance for connected operation from your mobile device. For additional assistance, visit <http://www.kenmore.com/smart>

**NOTE:** When successfully connected to the internet, the SMART icon LED on the control panel will turn on.

---

## My Cycle

Use the My Cycle feature in the Kenmore Smart™ app to select and download an additional cycle to your dishwasher. The default My Cycle on the dishwasher is Extended Total Care. Use the Kenmore Smart™ app to check which cycle has been downloaded.

---

## FCC Notice

(for transmitter module contained in this product)

This equipment has been tested and found to comply with the limits for a Class B digital device, pursuant to Part 15 of the FCC Rules. These limits are designed to provide reasonable protection against harmful interference in a residential installation. This equipment generates, uses, and can radiate radio frequency energy and, if not installed and used in accordance with the instructions, may cause harmful interference to radio communications. However, there is no guarantee that interference will not occur in a particular installation. If this equipment does cause harmful interference to radio or television reception, which can be determined by turning the equipment off and on, the user is encouraged to try to correct the interference by one or more of the following measures:

- Reorient or relocate the receiving antenna.
- Increase the separation between the equipment and receiver.
- Connect the equipment to an outlet on a circuit different from that to which the receiver is connected.
- Consult the dealer or an experienced radio/TV technician for help.

This device complies with part 15 of the FCC rules.

Operation is subject to the following two conditions:

- (1) this device may not cause harmful interference, and
- (2) this device must accept any interference received, including interference that may cause undesired operation of the device.

Any changes or modifications in construction of this device which are not expressly approved by the party responsible for compliance could void the user's authority to operate the equipment.

### Open Source Software Notice

To obtain the source code that is contained in this product under LGPL and other open source licenses, visit <http://kenmore.com/opensource>. In addition to the source code, all referred license terms, warranty disclaimers, and copyright notices are available for download.

### FCC RF Radiation Exposure Statement

This equipment complies with FCC radiation exposure limits set forth for an uncontrolled environment. This transmitter must not be co-located or operating in conjunction with any other antenna or transmitter.

This equipment should be installed and operated with a minimum distance of 20 cm (7.8 inches) between the antenna and your body. Users must follow the specific operating instructions for satisfying RF exposure compliance.

### Labeling

This device includes the following module.

Contains FCC ID: 2AHU4-KMTD17

---

## Wireless LAN Module Specifications

<b>Model</b>	ASR-2KL
<b>Frequency Range</b>	2400 to 2483 MHz
<b>Output Power (Max)</b>	IEEE 802.11 b : 20 dBm IEEE 802.11 g : 17 dBm IEEE 802.11 n : 17 dBm

# WASHING SPECIAL ITEMS

If you have doubts about washing a particular item, check with the manufacturer to see if it is dishwasher safe.

Material	Dishwasher Safe?	Comments
Aluminum	<b>Yes</b>	High water temperature and detergents can affect finish and color of aluminum.
Disposable Aluminum	<b>No</b>	Do not wash disposable aluminum pans in the dishwasher. These might shift during washing and transfer black marks to dishes and other items.
Bottles and Cans	<b>No</b>	Wash bottles and cans by hand. Labels attached with glue can loosen and clog the wash system and reduce washing performance.
Cast Iron	<b>No</b>	Seasoning will be removed and the cookware will rust.
China/Stoneware	<b>Yes</b>	Always check manufacturer's recommendations before washing. Antique, hand-painted, or over-the-glaze patterns may fade. Gold leaf can discolor or fade.
Crystal	<b>Yes</b>	Always check manufacturer's recommendations before washing. Some types of leaded crystal can etch with repeated washing.
Gold	<b>No</b>	Gold-colored flatware will discolor.
Glass	<b>Yes</b>	Milk glass material yellows with repeated dishwasher washing.
Hollow-Handle Knives	<b>No</b>	Handles of some knives are attached to the blade with adhesives which can loosen if washed in the dishwasher.
Pewter, Brass, Bronze, and Copper	<b>No</b>	High water temperatures and detergent can discolor or pit the finish.
Disposable Plastics	<b>No</b>	Cannot withstand high water temperatures and detergents.
Plastics	<b>Yes</b>	Always check manufacturer's recommendations before washing. Plastic items may vary in their ability to withstand high temperatures and detergents. It is recommended that lightweight items such as lids and butter dishes be placed in the upper rack only. Sturdy items such as coolers and high-chair trays may be placed in the lower rack.
Stainless Steel	<b>Yes</b>	Run a rinse cycle if not washing immediately. Prolonged contact with food containing salt, vinegar, milk products, or fruit juice can damage the finish.
Sterling Silver or Silver Plate	<b>Yes</b>	Run a rinse cycle if not washing immediately. Prolonged contact with food containing salt, acid, or sulfide (eggs, mayonnaise, and seafood) can damage finish. Do not wash Sterling Silver silverware with Stainless Steel silverware because electrolytic action will discolor and pit the metals where they touch.
Tin	<b>No</b>	Not recommended
Wooden Ware	<b>No</b>	Wash by hand. Always check manufacturer's instructions before washing. Untreated wood can warp, crack, or lose its finish.
Large Casserole Dish	<b>Yes</b>	Adjust the tines as necessary to load large dishes.

---

# DISHWASHER CARE

---

## Cleaning

### Cleaning the Exterior

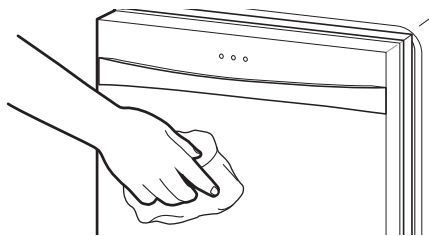

In most cases, regular use of a soft, dry towel is all that is necessary to keep the outside of the dishwasher looking nice and clean. If the dishwasher has a stainless steel exterior, a stainless steel cleaner is recommended.

---

### Cleaning the Interior

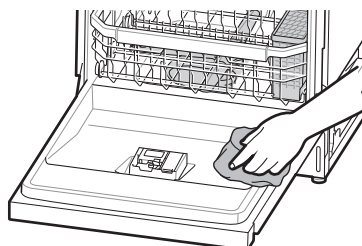

Hard water minerals can cause a white film to build up on the inside surfaces, especially just beneath the door area.

Do not clean the dishwasher interior until it has cooled. You may want to wear rubber gloves. Do not use any type of cleanser other than dishwasher detergent because it may cause foaming or sudsing.

#### To Clean Interior:

Make a paste with powdered dishwasher detergent on a damp sponge and clean.

**OR**

Use liquid automatic dishwasher detergent and clean with a damp sponge.

**OR**

See the vinegar rinse procedure in “Cloudy or spotted dishware” in “Troubleshooting” section.

**NOTE:** Run a normal cycle with dishwasher detergent after cleaning the interior.

---

## Dishwasher Maintenance Procedure

To help avoid hard water residue in your dishwasher, use affresh® Dishwasher Cleaner (recommended) once a month as part of routine maintenance. Using affresh® Dishwasher Cleaner is effective in all dishwasher brands.

### IMPORTANT:

- Read these instructions and the instructions found on the affresh® product package completely before beginning the cleaning process.

### Removal of Hard Water/Filming

1. Load the dishwasher (preferably with dishes affected by filming/hard water).
2. Place tablet in main wash compartment of detergent dispenser or in the bottom of the tub.
3. Select cycle/option best for heavily soiled dishes and start dishwasher.

### NOTE:

- Purchase affresh® Dishwasher Cleaner, part number W10282479, online at: [www.searspartsdirect.com](http://www.searspartsdirect.com) or [searsoutlet.com](http://searsoutlet.com)
- If filming is a problem, switch to a premeasured detergent tablet or pack for regular daily use.

---

## Drain Air Gap

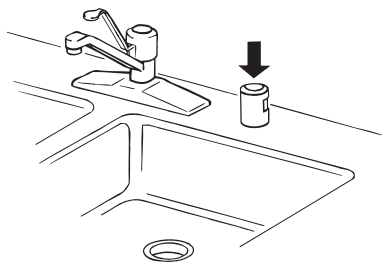

Some state or local plumbing codes require the addition of a drain air gap between a built-in dishwasher and the home drain system. Check the drain air gap when your dishwasher is not draining well.

The drain air gap is usually located on top of the sink or counter top near the dishwasher. To order a drain air gap, call **1-844-553-6667**. Ask for Part Number 300096. You may also purchase the part online:

**www.searspartsdirect.com.**

**NOTE:** The drain air gap is an external plumbing device that is not part of your dishwasher. The warranty provided with your dishwasher does not cover service costs directly associated with the cleaning or repair of the external drain air gap.

---

### Cleaning the Drain Air Gap

Clean the drain air gap periodically to ensure proper drainage of your dishwasher.

With most types, you lift off the chrome cover. Unscrew the plastic cap. Then check for any soil buildup. Clean if necessary.

---

## Vacation or Extended Time Without Use

### Avoiding Property Damage

- If you will not be using the dishwasher during the summer months, turn off the water and power supply to the dishwasher.
- Make sure the water supply lines are protected against freezing conditions. Ice formations in the supply lines can increase water pressure and damage your dishwasher or home. Damage from freezing is not covered by the warranty.
- When storing your dishwasher in the winter, avoid water damage by having your dishwasher winterized by authorized service personnel.

# DIAGNOSTICS

Should you experience any problems with your dishwasher, it has the capability of transmitting data via your telephone to the Diagnostics Team. This gives you the capability of speaking directly to our specially trained technicians. The technician records the data transmitted from your machine and uses it to analyze the issue, providing a fast and effective diagnosis.

If you experience problems with your dishwasher, call 1-844-553-6667. Only use the Diagnostics feature when instructed to do so by the Diagnostics Team. The transmission sounds that you will hear are normal and sound similar to a fax machine.

Diagnostics cannot be activated unless your dishwasher is turned on by pressing the Power button. If your dishwasher is unable to turn on, then troubleshooting must be done without using Diagnostics.

## Using Diagnostics

First, call 1-844-553-6667. If the number of the phone you are using is on file and is associated with your dishwasher, you will be quickly relayed to a Diagnostics team agent. Follow the technician's instructions and perform the following steps only when requested to by the Diagnostics team agent.

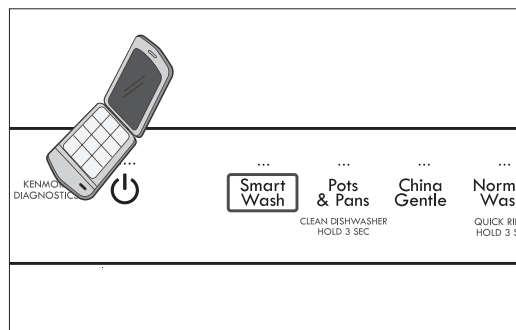
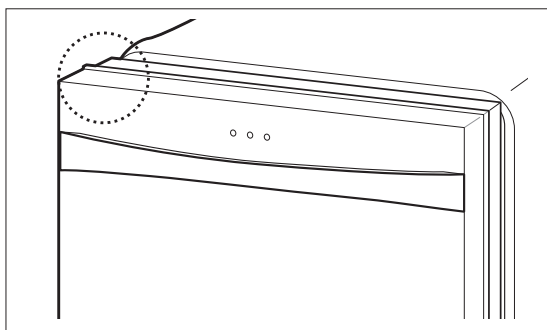

HOLD the mouthpiece of your phone over the speaker near the Power button, when instructed to do so by the Diagnostics Team agent. Hold the phone no more than one inch (but not touching) the machine.

**NOTE:** Do not touch any other buttons or icons on the display.



PRESS AND HOLD the My Cycle button while continuing to hold your phone to the Power button.



LISTEN for three beeps. After you hear the three beeps, release the My Cycle button.

Keep the phone in place until the tone transmission has finished. This takes about 6 seconds, and the display will count down the time. Once the countdown is over and the tones have stopped, resume your conversation with the technician, who will then be able to assist you in using the information transmitted for analysis.

**NOTE:**

- For best results, do not move the phone while the tones are being transmitted.
- If the call center agent is not able to get an accurate recording of the data, you may be asked to try again.

# TROUBLESHOOTING

CHECK THESE POINTS TO HELP SAVE YOU TIME AND MONEY.

Problem	Possible Cause	Solutions
Dishwasher will not operate.	Start button is not pressed.	<ul style="list-style-type: none"> <li>Press the Start button.</li> </ul>
	Door is not completely closed.	<ul style="list-style-type: none"> <li>Make sure that the door is completely closed and latched.</li> </ul>
	Power supply or power cord is not connected.	<ul style="list-style-type: none"> <li>Connect the power supply or cord properly.</li> </ul>
	Fuse is blown or circuit breaker tripped.	<ul style="list-style-type: none"> <li>Replace the fuse or reset the circuit breaker.</li> </ul>
	Control Lock is activated.	<ul style="list-style-type: none"> <li>Deactivate Control Lock.</li> </ul>
Dishwasher operates too long.	Dishwasher is connected to cold water.	<ul style="list-style-type: none"> <li>Check the water supply connection or water heater setting. (Heating cold water takes longer.)</li> </ul>
Odor	The previous cycle was stopped before completion and residual water remains in the dishwasher.	<ul style="list-style-type: none"> <li>Turn on the power, follow the instructions under Canceling a Cycle to remove the residual water, then run the Express Wash cycle using detergent but with the dishwasher empty.</li> </ul>
	There is food in the bottom of the unit or in the filter.	<ul style="list-style-type: none"> <li>Clean the filter and the interior according to the Cleaning the Filters and Dishwasher Care sections of this Use &amp; Care Guide.</li> </ul>
	Unwashed dishes are left in the unit for a long time.	<ul style="list-style-type: none"> <li>Run a cycle with one cup of white vinegar in a dishwasher safe glass or bowl placed on the upper rack. (Vinegar is an acid, and with constant use it could damage your appliance.)</li> </ul>
Water remains in tub after completion of cycle.	Drain hose is kinked or clogged.	<ul style="list-style-type: none"> <li>Adjust hose or clear blockage.</li> </ul>
Food soil remains on dishes.	Improper cycle selection.	<ul style="list-style-type: none"> <li>Select correct cycle based on soil level and type of dishware being washed.</li> </ul>
	Water temperature is too low.	<ul style="list-style-type: none"> <li>Check water supply connection or water heater setting.</li> </ul>
	Dishwashing detergent was not used.	<ul style="list-style-type: none"> <li>Use recommended detergent.</li> </ul>
	Low inlet water pressure.	<ul style="list-style-type: none"> <li>Water pressure should be between 20 and 80 psi.</li> </ul>
	Water jet holes on spray arms blocked.	<ul style="list-style-type: none"> <li>Clean the spray arms.</li> </ul>
	Improper loading of dishes.	<ul style="list-style-type: none"> <li>Make sure dishes do not block spray arm rotation or interfere with detergent dispenser.</li> </ul>
	Filters are clogged.	<ul style="list-style-type: none"> <li>Clean filters.</li> </ul>

Problem	Possible Cause	Solutions
Cloudiness on glassware.	Combination of excessive detergent and hard water.	<ul style="list-style-type: none"> <li>Use less detergent and use a rinse aid to minimize the problem.</li> </ul>
Black or gray marks on dishes.	Aluminum items rubbing dishes during cycle.	<ul style="list-style-type: none"> <li>Reposition the dishes.</li> </ul>
Spots and filming on dishes.	Low water temperature.	<ul style="list-style-type: none"> <li>Water supply should be at least 120 °F for best wash performance.</li> </ul>
	Wrong amount of detergent used.	<ul style="list-style-type: none"> <li>Use the recommended amount of detergent.</li> </ul>
	Overloading.	<ul style="list-style-type: none"> <li>Do not overload the dishwasher.</li> </ul>
	Improper loading.	<ul style="list-style-type: none"> <li>See the Operation section.</li> </ul>
	Insufficient water pressure.	<ul style="list-style-type: none"> <li>Water pressure should be between 20 and 80 psi.</li> </ul>
	Insufficient detergent.	<ul style="list-style-type: none"> <li>Add the recommended amount of detergent. See the Operation section.</li> </ul>
	Rinse aid dispenser is empty.	<ul style="list-style-type: none"> <li>Refill rinse aid dispenser.</li> </ul>
	Hard water buildup in the tub	<ul style="list-style-type: none"> <li>Remove all dishes, silverware and silverware holder from dishwasher. Only racks should remain in tub. For best results, use citric acid powder (can be found in canning sections of most grocery stores or online). Measure 3 tablespoons (45 g) of citric acid powder. Fill main wash compartment with measured powder. If you cannot find citric acid powder, pour approximately 1 <math>\frac{3}{4}</math> -2 cups (400-500mL) of white vinegar into shallow bowl and place in lower rack. Run Normal Wash cycle with Quick Rinse and Hi Temp Wash options. DO NOT USE DETERGENT.</li> </ul>
Noise	Some level of noise is normal during operation.	<ul style="list-style-type: none"> <li>Detergent cover opening.</li> <li>Drain pump at the beginning of drain cycle.</li> </ul>
	The dishwasher is not level.	<ul style="list-style-type: none"> <li>Adjust leveling feet.</li> </ul>
	Nozzle arm knocking against dishes.	<ul style="list-style-type: none"> <li>Reposition the dishes.</li> </ul>

Problem	Possible Cause	Solutions
Yellow or brown film on inside surfaces of dishwasher.	Coffee or tea stains.	<ul style="list-style-type: none"> <li>Eliminate the stain by using a stain removal product.</li> </ul>
Dishes don't dry.	Rinse agent dispenser empty.	<ul style="list-style-type: none"> <li>Check and refill the rinse agent dispenser if empty.</li> </ul>
Lamps do not illuminate.	Power is not connected.	<ul style="list-style-type: none"> <li>Connect power supply.</li> </ul>
Spray arms do not rotate smoothly.	Holes of spray arms are blocked by food particles.	<ul style="list-style-type: none"> <li>Clean the holes of spray arms.</li> </ul>
Top rack is crooked.	Rack is poorly adjusted.	<ul style="list-style-type: none"> <li>See the Height Adjustable Top Rack section.</li> </ul>
Dishwasher continuously beeps when the door is opened, during or right after a cycle has completed.	The contents of the dishwasher are hot and care should be used when placing your hands inside the dishwasher.	<ul style="list-style-type: none"> <li>Close the door until the dishwasher and dishes have cooled down. The beeping will stop if the door is closed or the interior temperature has cooled.</li> </ul>
Dishwasher chimes if panel is touched during operation.	Bumping into or touching the control panel during operation may result in a disabled button sound. Only the Power, Start, and Control Lock buttons are enabled during operation to prevent cycle settings from being changed inadvertently.	<ul style="list-style-type: none"> <li>Button sounds can be turned off by pressing and holding Mixed Load and Eco Wash for three seconds.</li> <li>The end of cycle chime and safety alert sounds will still sound.</li> </ul>
Dishwasher did not finish cycle.	Door was opened during cycle.	<ul style="list-style-type: none"> <li>If the door is opened during a cycle, the Start key must be pressed within 4 minutes or the machine turns off and all settings are lost.</li> </ul>
Leaking in front of unit	Dishwasher not leveled properly.	<ul style="list-style-type: none"> <li>Verify the unit is level from side to side and from front to back. See leveling instructions in the Installation section.</li> </ul>
	Wrong detergent used.	<ul style="list-style-type: none"> <li>If excessive sudsing is causing the leak, allow the foam to subside for 24 hours then clean the inside of the tub with milk.</li> </ul>
n:#, U:#, d:#, t# appears in display. (# = a number)	Test mode is selected.	<ul style="list-style-type: none"> <li>This is not an error code. This code is used when testing the dishwasher. Power the unit off and on and the code will disappear.</li> </ul>
L0, L1, L2, L3 or L4 appears in display.	Rinse Aid Level setting mode is selected.	<ul style="list-style-type: none"> <li>This is not an error code. This code indicates the current rinse aid level. For more information, refer to the Detergent and Rinse-aid section.</li> </ul>
CL appears in display.	Control Lock is activated.	<ul style="list-style-type: none"> <li>This is not an error code. This code indicates that the control lock is activated. Press and hold Half Rack and Eco Wash simultaneously for three seconds.</li> </ul>

## Error Codes

Problem	Possible Cause	Solutions
IE Error	Water inlet problem.	<ul style="list-style-type: none"> <li>• Check for a clogged, kinked or frozen water inlet hose.</li> <li>• Check water supply.</li> </ul>
OE Error	Drainage problem.	<ul style="list-style-type: none"> <li>• Check for a clogged, kinked or frozen drain hose.</li> </ul>
	Air gap or disposal is clogged.	<ul style="list-style-type: none"> <li>• Clean air gap or disposal.</li> </ul>
	Filters are clogged.	<ul style="list-style-type: none"> <li>• Clean filters.</li> </ul>
AE Error	Water leakage problem.	<ul style="list-style-type: none"> <li>• Turn off the water supply to the dishwasher and call 1-844-553-6667. (U.S.A.)</li> <li>• The dishwasher makes an alert sound for 10 seconds, and runs the drain pump intermittently. If power is turned off to the machine, the machine powers back on automatically until the AE error is resolved.</li> </ul>
FE Error	Excessive water supplied.	<ul style="list-style-type: none"> <li>• Please call 1-844-553-6667. (U.S.A.)</li> </ul>
HE Error	Heater circuit failure.	
tE Error	Thermistor failure or very high inlet water temperature (over 194 °F)	
LE Error	Motor trouble	
nE Error	Vario motor trouble	



# Kenmore®

## Customer Care Hotline

To schedule in-home repair service  
or order replacement parts

Para pedir servicio de reparación  
a domicilio, y ordenar piezas

# 1-844-553-6667

[www.kenmore.com](http://www.kenmore.com)

