



Text 1-812-652-2525
(US and Canada only, carrier fees may apply)



Visit www.maxicosi.com



Call 1-800-544-1108



Email support@djgusa.com



Learn More

©2026 Dorel Juvenile Group, Inc. (800) 951-4113 www.maxicosi.com. Styles, colors, and labeling may vary. Made in China. Distributed by Dorel Juvenile Group, Inc., 2525 State St., Columbus, IN 47201-7494. Dorel Juvenile Canada, 2233 Argentia Road, Suite 110, Mississauga, ON L5N 2X7. Representante exclusivo en Chile: DOREL JUVENILE CHILE S.A. Av. del Parque 4161, oficina 602 A, Huechuraba, Santiago, Chile - Fono: 56 2 24971500 - www.infanti.cl - www.dorel.cl. Importado y distribuido en Perú por: COMEXA COMERCIALIZADORA EXTRANJERA S.A. SUCURSAL DEL PERÚ - Los Libertadores 455, San Isidro, Lima 27, Lima, Perú RUC 20431062870 - Fono: 4413029 - www.infanti.com.pe. En Centro América, Caribe y Ecuador por: Best Brands Group S.A. - Av. Balboa, Bay Mall Plaza, Planta Baja, local 9, Panamá. - Fono: (507) 300 2884. En Colombia por: Baby Universe S.A.S. - Vía 40 No. 77-29, Barranquilla, Colombia - Fono: (575) 353 1110 Importador: DJGM, S.A. DE C.V. Gabriel Mancera No. 1041 Del Valle, Benito Juárez C.P. 03100 México, Ciudad de México R.F.C. DJG140305GN9 Tel. (55) 67199202



MAXI-COSI®

Ambra Infant Car Seat

Your model may look different than the one shown.

Read all instructions before using this car seat.
KEEP INSTRUCTIONS FOR FUTURE USE.

⚠ Failure to follow the warnings on the labels and in the instruction manual can result in serious injury or death to your child. Serious injury may include paralysis and/or permanent brain injury.

4358-8762B 01.27.26



Table of Contents

| | | | | | | | |
|---|----|--|-----------|---|----|--------------------------------------|----|
| Getting Started..... | 4 | Using the Car Seat with an Installed Base..... | 35 | Cleaning the Seat Pad Set and Parts of the Car Seat..... | 65 | Replacement and Expiration..... | 90 |
| Parts of the Car Seat..... | 5 | Securing Your Child in the Car Seat..... | 38 | Removing and Installing the Harness System..... | 66 | Registration and Safety Notices..... | 91 |
| Accessory Use..... | 8 | Rear-Facing Mode..... | 43 | Installing the Seat Pad Set..... | 74 | Aircraft Information..... | 92 |
| Car Seat Mode Information..... | 13 | Rear-Facing Child Fit Requirements..... | 45 | Installing the Canopy Hoop..... | 78 | Warranty..... | 93 |
| Using the Canopy..... | 14 | Rear-Facing Use with an Installed Base..... | 49 | Vehicle Belt and LATCH Information..... | 79 | Replacement Parts..... | 95 |
| Carrier Use..... | 15 | Vehicle Installation without the Base..... | 51 | Vehicle Belts..... | 80 | | |
| Using the Load Leg..... | 17 | Adjusting the Buckle Strap for Smaller Infants..... | 56 | LATCH: Lower Anchor Bars..... | 84 | | |
| Vehicle Installation with the Base..... | 19 | Wash and Care..... | 59 | Safety Information..... | 86 | | |
| Installing the Base with a Vehicle Belt..... | 20 | Removing the Canopy..... | 60 | Child Restraint Use..... | 87 | | |
| Installing the Base with Rigid LATCH Connectors..... | 26 | Removing the Seat Pad Set for Cleaning..... | 61 | Vehicle Seating Position..... | 88 | | |
| Changing the Headrest/Harness Height..... | 30 | | | Installation in Vehicle..... | 89 | | |
| Changing the Buckle Position..... | 32 | | | | | | |

Getting Started

To help you get started using your child's new car seat (also known as a child restraint), these are the four main tasks you'll need to complete.

1

Install the car seat in your vehicle.

2

Measure your child.

3

Adjust the car seat to fit your child.

4

Secure your child in the car seat.

Parts of the Car Seat

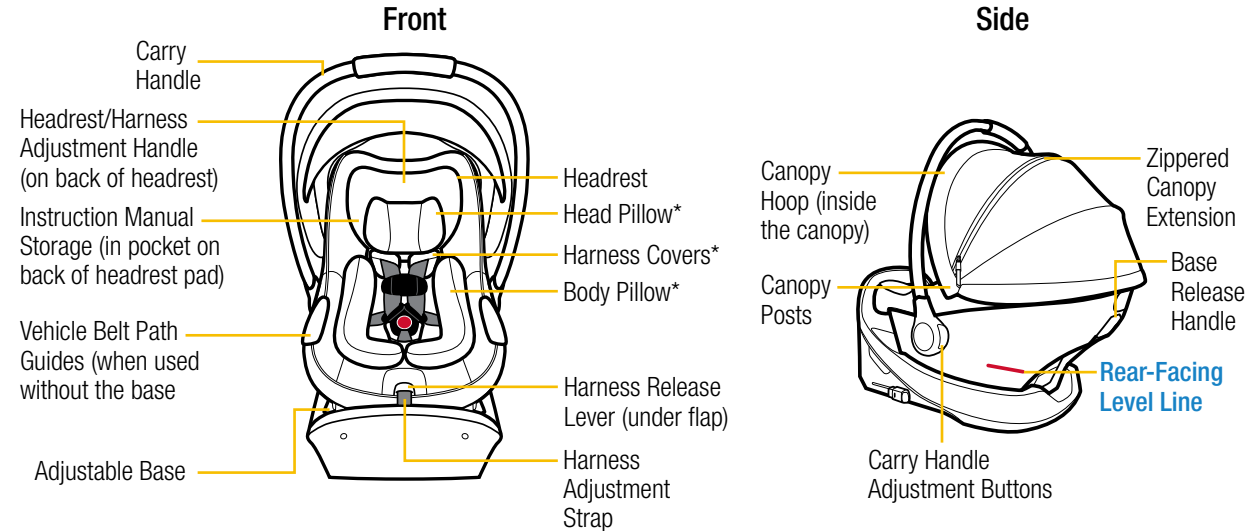

Your model may look different than the one shown. *See page 8 for accessory use.



Harness System

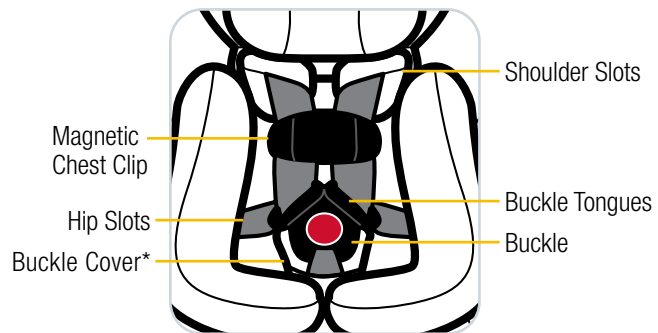

Bottom of the Car Seat

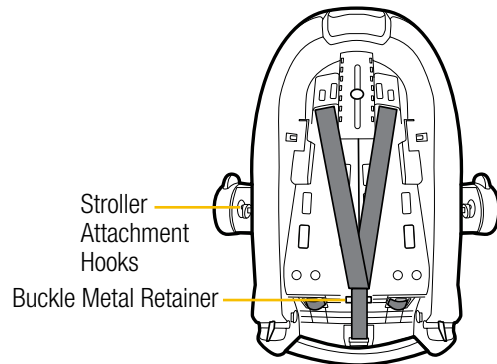

Base

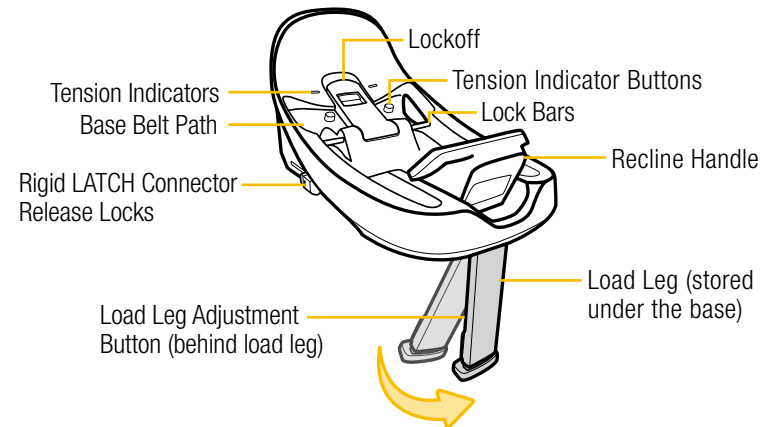

Head and Body Pillows

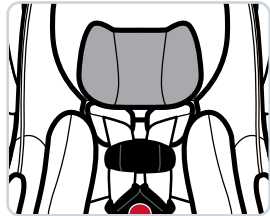

Head Pillow

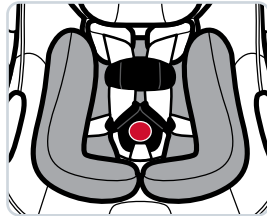
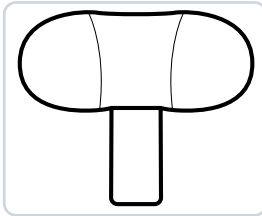

Body Pillow

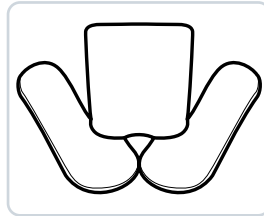

When using the head pillow, make sure it does not cover your infant's face in any way. **The head and body pillows MUST be used together and MUST be used for infants who do not have head control.**

To remove the head and body pillows:

1. Pull the head pillow up from behind the body pillow.
2. Unfasten the chest clip and press the red button to unbuckle the harness. Gently slide the body pillow out from behind the harness straps.

To install the head and body pillows:

1. Unfasten the chest clip and press the red button to unbuckle the harness. Place the center part of the body pillow, wedge side down, in the car seat below the harness shoulder slots and above the buckle strap. Route the harness straps around the sides of the pillow.
2. Place the head pillow above the body pillow and tuck the narrow center panel of the head pillow behind the upper part of the body pillow.

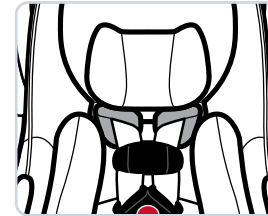

Harness Covers

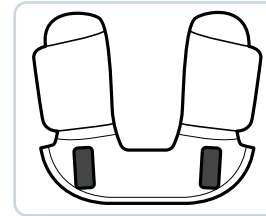

The harness covers help provide comfort to your child's neck. If the harness covers will not allow proper positioning of the chest clip or interfere with getting a tight-enough harness fit for a smaller infant, remove them and **DO NOT** use. Store them until your child is large enough to use the harness covers while maintaining a properly fitting harness.

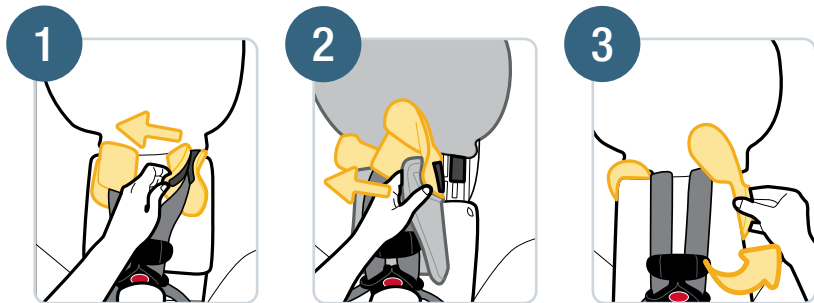

To remove the harness covers:

1. Pull apart the fastening strips and pull the harness straps out of both covers.
2. Pull back the headrest pad near the shoulder slot to access the bottom of the harness covers. Pull apart the fastening strip attaching the bottom of the harness cover to the car seat. Repeat on the other side.
3. Slide the harness covers out from behind the headrest pad.

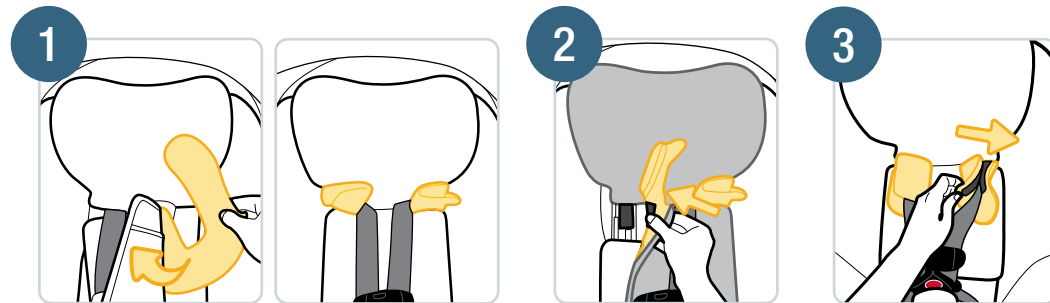

To install the harness covers:

1. Hold the harness covers as shown (fastening strip side down) and slide them behind the bottom of the headrest pad. Pull both sides of the harness covers through the shoulder slots.
2. Pull back the headrest pad near the shoulder slot and attach the fastening strip on the back of the harness cover to the car seat. Repeat on the other side.
3. Place the upper part of the harness strap above the chest clip into both harness covers. Refasten both sides of the fastening strip on each harness cover.

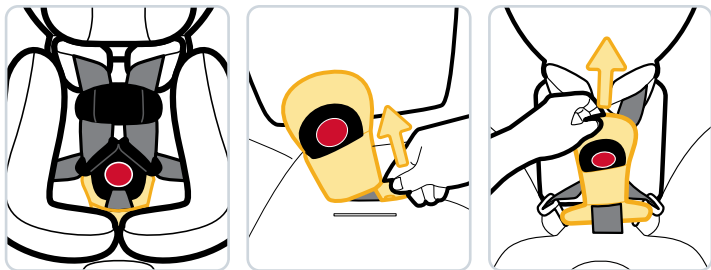

Buckle Cover

To remove the buckle cover: Undo the buckle. Reach into either the left or right edge of the buckle slot to lift the bottom part of the buckle cover out of the slot. Repeat on the opposite side of the buckle slot and then pull the buckle cover off the buckle.

To install the buckle cover: Undo the buckle. Slide the cover over the buckle. Tuck either the left or right bottom part of the cover behind the buckle strap into the same seat pad slot as the buckle. Repeat with the opposite side.

⚠ WARNING

Failure to follow these instructions may result in serious injury or death to your child. Serious injury can include paralysis and/or permanent brain injury. Be certain to measure your child's weight and height (do not guess) before using this car seat. This car seat can only be used **REAR-FACING**.

Your child's height, weight, and age determine how the car seat should be placed in the vehicle.

Children vary widely in body size, shape, and temperament—**please consult your doctor before switching between any modes within the limits and fit requirements of the car seat.**



Rear-Facing Mode

**4–30 lb (1.8–13.6 kg) and
32 in. (81.3 cm) or less in height**

This car seat can only be used **Rear-Facing**. In this **Rear-Facing** only car seat, your child can use this restraint until they outgrow any one of the above.

Rear-Facing Child Fit Requirements PAGE 45
Rear-Facing Use with an Installed Base PAGE 49
Vehicle Installation without the Base PAGE 51

Infants and Toddlers

Children must ride rear-facing and remain rear-facing until they reach the maximum weight or height limits for rear-facing mode. Rear-facing child restraints installed behind another vehicle seat must be installed touching the back of the vehicle seat in front of it, or be as close as possible.

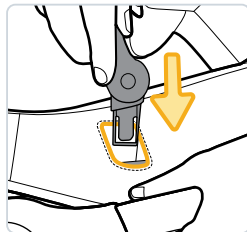

To install the canopy: Make sure the carrier handle is pushed all the way back (see next page). Insert the bottom of the canopy post into the slot on the side of the car seat through the opening on the side of the seat pad. Repeat with the other canopy post.

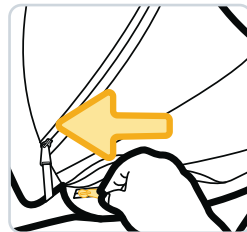

To complete the installation: Zip the canopy around the back of the seat pad.

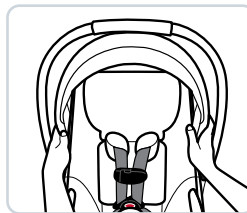

To adjust the canopy: Grasp both sides of the canopy hoop and move it front to back to the desired position.

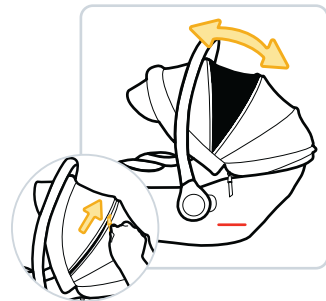
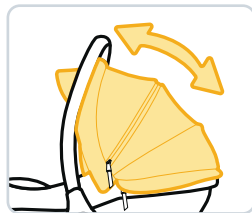

To extend the canopy: Unzip the canopy to extend it and open a mesh screen. To retract the extended canopy, grasp both sides of the canopy hoop and move it slightly back, and then zip it closed. To remove the canopy hoop for cleaning, see page 62.

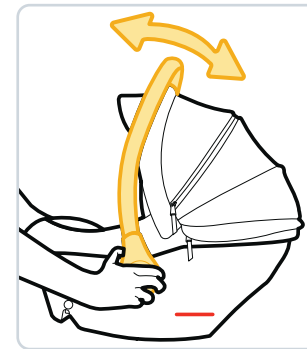
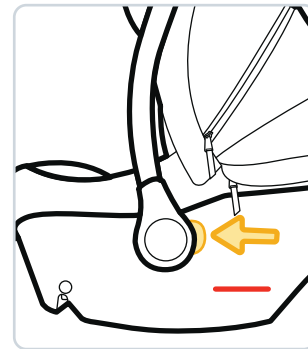

To adjust the carry handle position:

Squeeze the adjustment buttons on both sides of the carry handle.

Rotate the carry handle up or down to the desired position and then release both buttons. Make sure both adjustment buttons are in the locked position.

The carry handle **MUST** be upright **AND** locked when carrying and when installed in the vehicle.

⚠️ WARNING

Read **ALL** instructions before using child restraint as a carrier.

NEVER use carrier unless child is properly secured.

Use only as a carrier by children weighing 4–30 pounds (1.8–13.6 kg) and 32 inches (81.3 cm) or less in height.

NEVER leave child unattended. Always keep child within arm's reach.

Suffocation Hazard: Infant carrier can roll over on soft surfaces and suffocate child.

NEVER place carrier on beds, sofas, or other soft surfaces.

Strangulation Hazard: Children have **STRANGL**ED in loose or partially buckled harness straps. Fully restrain the child even when carrier is used outside the vehicle.



Fall Hazard: Child's activity can move carrier. **NEVER** place carrier on counter tops, tables, or any other elevated surface.

The carrier can fall from the shopping cart. **DO NOT** use on shopping cart.

DO NOT use the carrier if it is damaged or broken, or if any parts are missing.

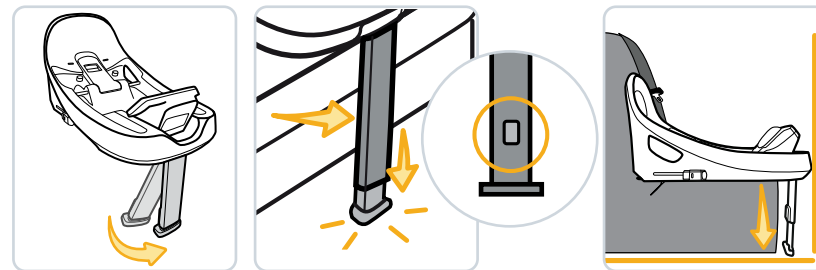

The load leg is an optional feature when installing the base with either a vehicle belt or rigid LATCH connectors. In a crash, load legs reduce downward rotation, limit rebound, and provide additional stability and energy absorption.

To extend the load leg:

1. Reach under the base and pull the load leg down from the storage compartment.

2. Press and hold the top of the button on the back of the load leg and pull the load leg down until it reaches the vehicle floor.
3. Release the button to lock the load leg in position.

When the base is installed, the load leg **MUST BE** perpendicular to the vehicle floor. **DO NOT** fully extend the load leg before installing the base with either a vehicle belt (see page 20) or rigid LATCH connectors (see page 26).

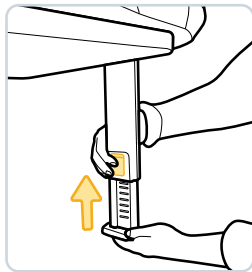

To close the load leg:

1. Press and hold the top of the button on the rear of the load leg with one hand while pushing up the load leg with the other. Release the button once the leg is fully retracted.
2. Fold the leg under the base until it snaps into place in the storage compartment.

⚠ WARNING

DO NOT use the load leg on top of vehicle storage compartments. Review your vehicle owner's manual.
DO NOT use the load leg if it does not reach the floor of your vehicle. When not in use, the load leg **MUST** be stored under the base.

There are two methods for installing the car seat base in your vehicle. **Use only one:**

Vehicle Belt



Lap/Shoulder Belt



Lap Belt

OR

Rigid LATCH Connectors



Before installing the car seat base:

- Review your vehicle owner's manual to determine the type of vehicle belts in your car and how to use them to lock a car seat base in place **OR** to locate the LATCH: lower anchor seating positions. See also Vehicle Belts on page 80 and LATCH: Lower Anchor Bars on page 84.
- Ensure the vehicle is on level ground when installing the base.
- See page 51 if you want to install the car seat without the base.

⚠ WARNING

DO NOT use both the rigid LATCH connectors and vehicle belt at the same time to install the base.

Installing the Base with a Vehicle Belt

1



Unfold the load leg

Reach under the base and pull the load leg down from the storage compartment to use this optional feature. In a crash, load legs reduce downward rotation, limit rebound, and provide additional stability and energy absorption. See page 17 for more details.

⚠️ WARNING

DO NOT fully extend to the vehicle floor yet. **DO NOT** use the load leg to adjust the base angle.

Review your vehicle owner's manual for load leg use.

2

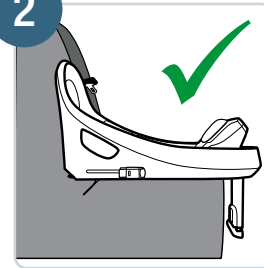

Place the base **Rear-Facing** in the back seat

Center the base in the chosen seating position and push it backwards until contact is made with the vehicle seatback. The car seat base **MUST** be as flat as possible on the vehicle seat.

3



Lift the lockoff release lever

Keep the lockoff open to route the belt.

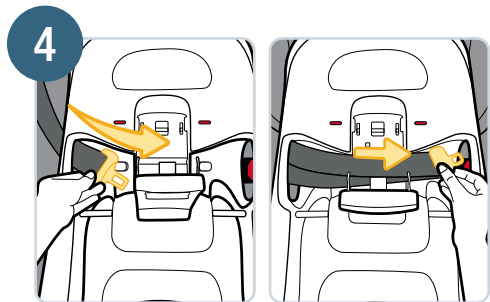

Route the vehicle belt through the base belt path

Insert the lap belt or the lap/shoulder belt into the belt path opening on the base. Pull it across the base and out through the belt path opening on the other side.

DO NOT twist the belt.

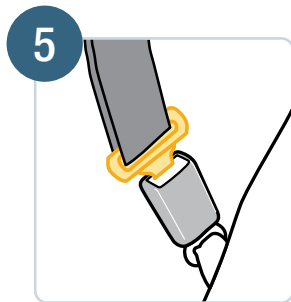

Buckle the vehicle belt

If your vehicle belt has a switchable retractor, wait to put it in locking mode until step 8.

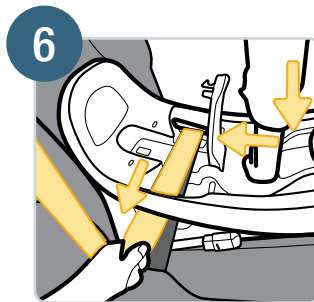

Tighten the belt

Place your hand in the base. Firmly push the base down and back towards the vehicle seatback while pulling the belt towards you in line with the belt path.

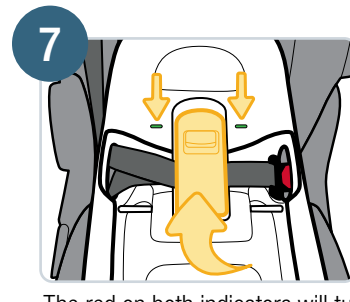

The red on both indicators will turn completely green when the vehicle belt is tightened correctly over both buttons in the belt path. No red should be showing and the base should not move more than 1 in. (2.5 cm) when holding the base at the belt path with your non-dominant hand and pushing and pulling it side to side.

Push the release lever down to close the lockoff and check the tension indicators

If red is showing in one or both indicators or the base moves more than 1 in. (2.5 cm) side to side at the belt path, try:

- Pulling the belt tighter; **OR**
- Making sure the shoulder belt portion of the belt is tucked neatly over the lap portion of the belt in the belt path; **OR**
- Wiggling the base to even out the tension in the belt; **OR**
- Checking that the base is straight and centered on the vehicle seat; **OR**
- Reinstalling the car seat; **OR**
- Changing to a different seating location.

For help with installation, please call Consumer Care at 1-800-544-1108.



If red is still showing or the lockoff cannot close properly, then install the base with the rigid LATCH connectors (see page 26) or install the seat without the base (see page 51).

Note: The tension indicators may not function correctly if the rigid LATCH connectors are not completely retracted. If the indicators are red but you are having trouble closing the lockoff, you may need to loosen the belt slightly to get the lockoff to completely close.

8

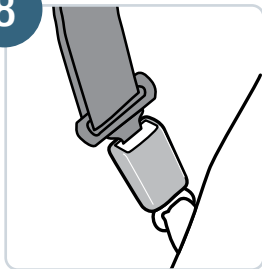

Put the switchable retractor in locking mode

If your vehicle belt has a switchable retractor, make sure it is in locking mode. Refer to page 82 or your vehicle owner's manual.

9

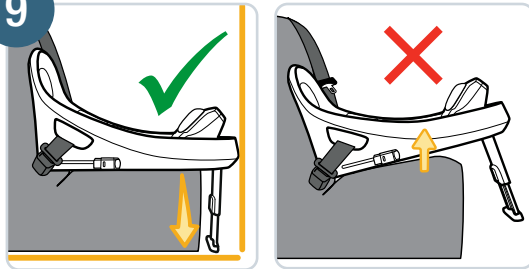

Extend the load leg

Press and hold the top of the button on the back of the load leg and pull the load leg down until it reaches the vehicle floor.

Release the button to lock the load leg in position. The load leg **MUST** be perpendicular to the vehicle floor.

⚠ WARNING

DO NOT use the load leg if it does not reach the floor of your vehicle. **DO NOT** use the load leg on top of vehicle storage compartments. Review your vehicle owner's manual.

FINISHED!

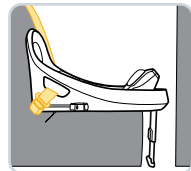

Lap/Shoulder Belt

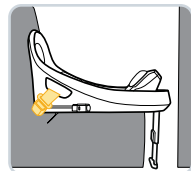

Lap Belt



When using the passenger and driver side locations, the car seat **MUST** be touching the back of the seat in front of it, or be as close as possible.

- Is the vehicle belt locked? See step 5.
- Is the belt tightened enough so that both tension indicators are fully green? Check the tightness of the install often to make sure it has not loosened. See step 7.

To use a car seat with the base, see page 35.

Installing the Base with Rigid LATCH Connectors

1



Unfold the load leg

Reach under the base and pull the load leg down from the storage compartment to use this optional feature. In a crash, load legs reduce downward rotation, limit rebound, and provide additional stability and energy absorption. See page 17 for more details.

WARNING

DO NOT fully extend to the vehicle floor yet. **DO NOT** use the load leg to adjust the base angle. Review your vehicle owner's manual for load leg use.

2

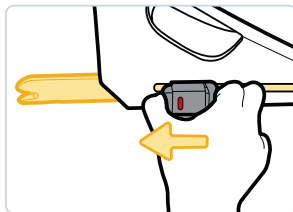
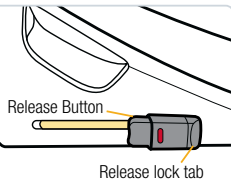

Extend the rigid LATCH connectors from the base

Push to tilt the release lock tab backwards and then push in the release button on the other end to slide the release lock and extend the connector (you may need to pull the extender slightly toward the front of the base first before it will slide freely and fully extend). Repeat on the other side of the base.

3

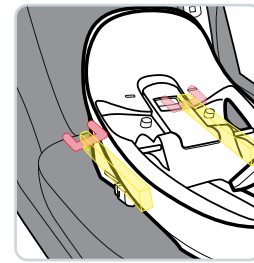
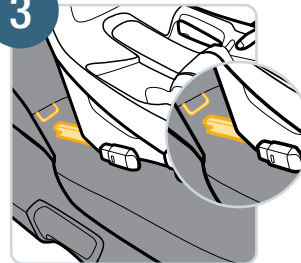

Attach the rigid LATCH connectors to the vehicle

Place the base on the vehicle seat so that both rigid LATCH connectors are aligned with the lower anchors. Push both sides of the base evenly towards the vehicle seatback until both connectors are attached to the anchors **AND** the base is as flat as possible against the vehicle seatback. The connectors will ratchet into the base of car seat as you push it into the seat cushion.

The car seat base **MUST** be as flat as possible on the vehicle seat.

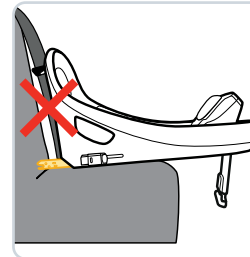

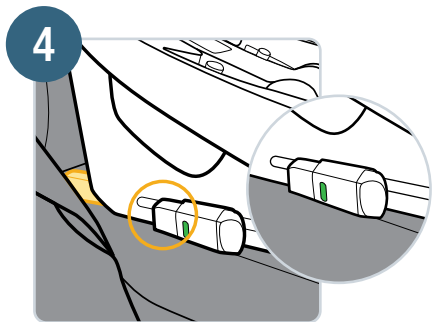

4 Check the rigid LATCH connector installation

Verify the car seat is securely attached to the lower anchors by checking the green indicator on both rigid LATCH connector release locks **AND** pulling the base away from the vehicle seatback.

If the green does not appear on either side or the rigid LATCH connectors are not properly connected to the lower anchors when you pull the car seat away from the vehicle seatback, then repeat steps 2 and 3.

For help with the installation, please call Consumer Care at 1-800-544-1108 or scan the QR code on the back cover of this manual.

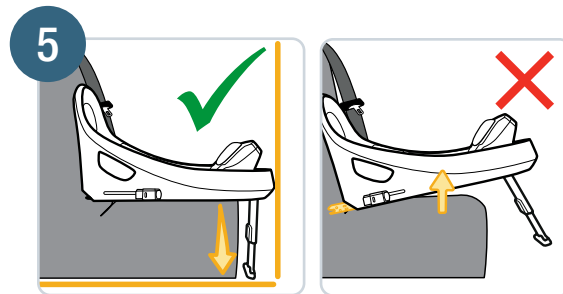

5 Extend the load leg

Press and hold the top of the button on the back of the load leg and pull the load leg down until it reaches the vehicle floor.

Release the button to lock the load leg in position. The load leg **MUST** be perpendicular to the vehicle floor.

⚠ WARNING

DO NOT use the load leg if it does not reach the floor of your vehicle. **DO NOT** use the load leg on top of vehicle storage compartments. Review your vehicle owner's manual.

FINISHED!

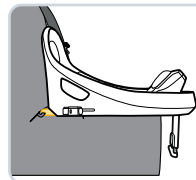

When using the passenger and driver side locations, the car seat **MUST** be touching the back of the seat in front of it, or be as close as possible.

Are the rigid LATCH connectors securely attached to the vehicle's lower anchors? See step 4.

To use a car seat with the base, see page 35.

Changing the Headrest/Harness Height

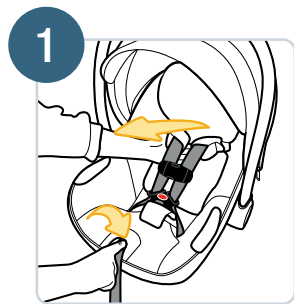

1 Fully loosen the harness straps

Push down on the harness release lever (through the opening in the seat pad) while pulling the harness straps away from the backrest.



2 Adjust the headrest/harness height

Squeeze the adjustment handle to move the headrest up or down and adjust the harness to the proper height for your child. Release the handle to lock the headrest at the chosen height.

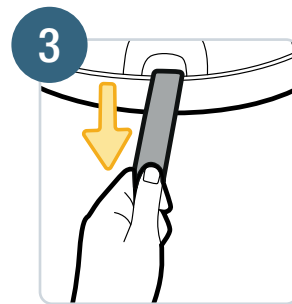

3 Tighten the harness adjustment strap

Pull the harness adjustment strap straight out to tighten the harness. Slide the chest clip up or down as needed.



For **Rear-Facing Child Fit Requirements**, see page 45.

To check harness tightness, see pages 38–41.

Check the harness straps often for any wear or damage.

Changing the Buckle Position

WARNING

Failure to place buckle's metal retainer completely through pad and child restraint can result in serious injury or death. Serious injury can include paralysis and/or permanent brain injury.

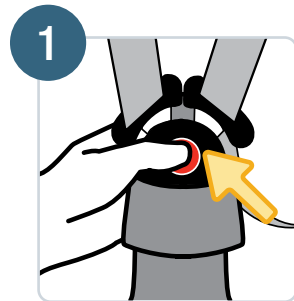

1 Unbuckle the harness

Press the red button to release the buckle tongues.

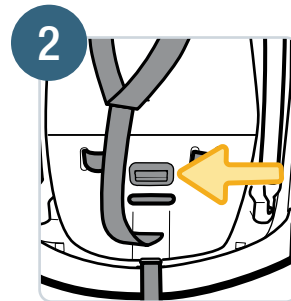

2 Turn the car seat over

Locate the buckle's metal retainer on the bottom of the car seat.

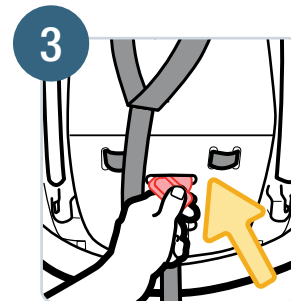

3 Rotate the metal retainer and push it through the slot

Push the metal retainer through the slot in both the car seat and the seat pad.

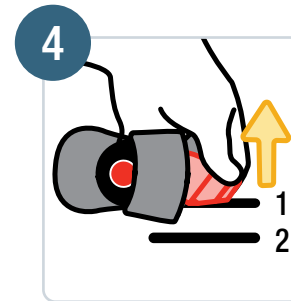

4 Pull the buckle and buckle cover out

From the top of the car seat, pull the buckle cover out if installed (see page 12 for more details). Pull the buckle out from the slot.



5 Insert the metal retainer into the slot closest to the child

The buckle **MUST** face out. The buckle strap should not be underneath or behind your child.

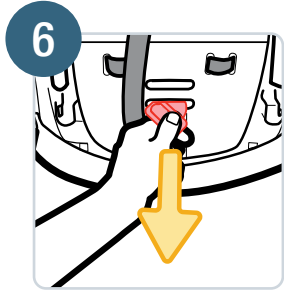

Pull the metal retainer through the slot

Turn the car seat over and pull the metal retainer completely through the slot in both the seat pad and the car seat. Rotate the metal retainer into position.

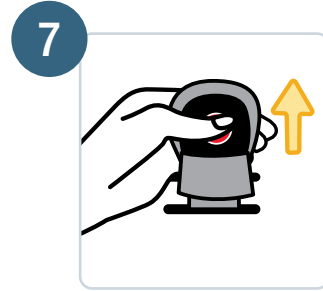

Check the buckle

Pull up on the buckle to make sure it is secured. The buckle **MUST NOT** pull out.



For **Rear-Facing Child Fit Requirements**, see page 45.

To check harness tightness, see pages 38–41.



The base **MUST** be installed in the vehicle before attaching the car seat. For details on installing the base with a vehicle belt, see page 20. For details on installing the base with rigid LATCH connectors, see page 26.

If you want to use the car seat without the base, see page 51.

Attaching the Car Seat to the Base

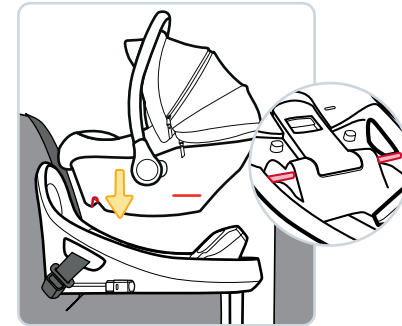

Align the slots on the side of the car seat with the lock bars on the base. Push down firmly on the carry handle and front of the car seat until it clicks, locking it in place on the base.

Pull up on the front two corners of the car seat by your child's feet to make sure it is locked to the base.

The carry handle **MUST** be upright and locked when installed in the vehicle.

See **Rear-Facing Use with an Installed Base** on page 49 for more details, including checking that the **Rear-Facing Level Line** is parallel to the ground.

To remove the car seat from the base, see page 37.

⚠ WARNING

When installing with a base, only use this car seat with a compatible Maxi-Cosi Infant Car Seat Base. Failure to use a correct base can cause serious injury or death.

DO NOT remove or damage the foam on the base. Using a base without foam or damaged foam can result in serious injury or death.

Failure to securely attach child restraint to base can result in serious injury or death. Serious injury can include paralysis and/or permanent brain injury.

Reclining the Car Seat

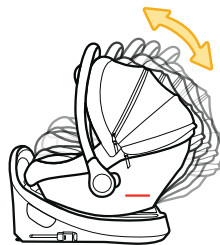
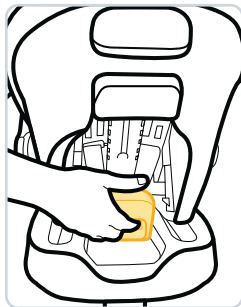

Use the recline handle to adjust the position of the car seat if the **Rear-Facing Level Line** is not parallel with the ground when the carrier is installed on the base.

1
2
3
4
5 Squeeze the recline handle while sliding it forward or back to adjust the angle of the car seat to one of five positions.

For children who cannot sit up unassisted, the **Rear-Facing Level Line** **MUST** be as close to parallel to the ground as possible using any position.

For children who can sit up unassisted, you may use any position to make the seat more upright.

Removing the Car Seat from the Base

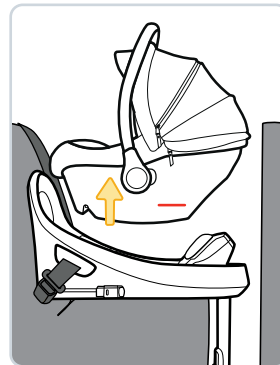
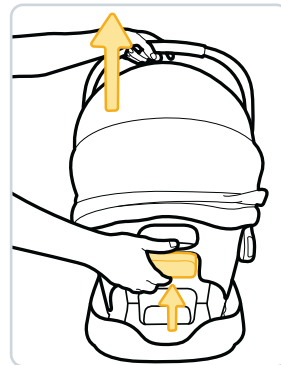

From the back of the car seat, slide the base release handle up and back and then lift the car seat straight up out of the base.

Securing Your Child in the Car Seat

WARNING

**IMPLANTED
ELECTRONIC
MEDICAL
DEVICES**

DO NOT use the magnetic chest clip with children who have an implanted electronic medical device.

A magnet is used to help secure the chest clip locking mechanism together which may interfere with the proper function of an implanted electronic medical device.

Parents or caregivers who have an implanted electronic device should keep their device away from the chest clip and consult their doctor and medical device manufacturer for specific information before using this chest clip. If a parent/caregiver or child has an implanted electronic medical device, please contact Dorel (see back cover) for a replacement (non-magnetic) chest clip free of charge.



Place your child in the car seat

Your child's bottom and back should be flat against the car seat.

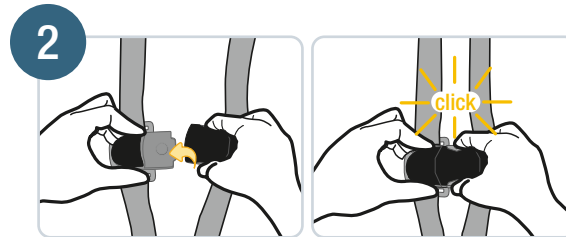

Fasten the chest clip

Lay the right (top) half of the chest clip over the left (bottom) half and it will automatically snap together and lock.

Gently pull on each half of the chest clip to make sure it is locked.

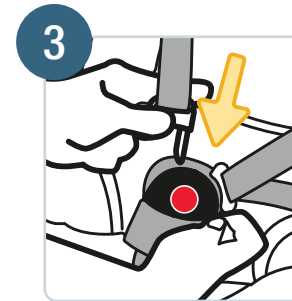

Buckle the harness

Push the buckle tongues into the buckle until they click. Pull the harness straps up to make sure the buckle is locked.

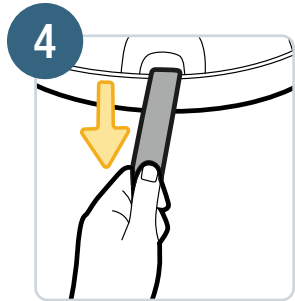

Tighten the harness

Pull the harness adjustment strap straight out to snugly tighten the harness system.

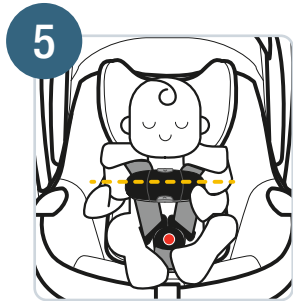

Position the chest clip

Slide the chest clip up the harness straps and position it at mid-chest (even with the armpits) and away from your child's neck.

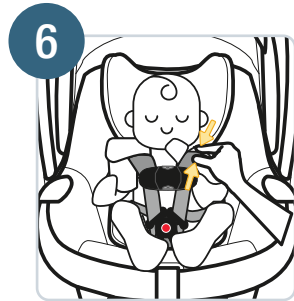

Check the harness tightness

If harness covers are installed, unfasten one of them. Try to pinch the harness at the shoulders vertically between your index finger and thumb as shown.

If your fingers slip off, the harness is tight enough.

If you can pinch the harness strap, tighten it more (see step 4).

Refasten the harness cover if applicable.



A snug strap should not allow any slack. It lies in a relatively straight line without sagging. It does not press on the child's flesh or push the child's flesh or push the child's body into an unnatural position.

If one side of the harness is tighter than the other, check to ensure that the clip in the seating area is centered.

FINISHED!



Your child is now secured in the car seat.

Check your child's fit often and make any needed adjustments to the car seat as they grow.

To remove your child from the car seat:

1. Loosen the harness straps. Push down on the harness release lever (through the opening in the seat pad) while pulling the harness straps away from your child.
2. Unfasten the chest clip. While holding both sides of the chest clip, press in on the top and bottom buttons and pull the chest clip apart.
3. Unbuckle the harness. Press the red button to release the buckle tongues.
4. Remove your child.

Troubleshooting

- **If the buckle or harness release lever sticks: DO NOT LUBRICATE THEM.** Check for dropped food, sticky spilled drinks, dirt, leaves, etc. Clean the buckle or harness release lever with warm water and remove any objects with tweezers. If you cannot adjust the harness to remain tight with the buckle securely locked, **DO NOT** use this car seat.
- **If the harness twists:** Straighten the harness each time you put your child in the car seat. When you remove your child, lock the buckle and tighten the harness so it will be ready for the next use.

! WARNING

Failure to fasten and tighten the harness system correctly may allow the child to be ejected from the child restraint in a crash or sudden stop causing serious injury or death. Serious injury can include paralysis and/or permanent brain injury.



DO NOT mistake comfort for safety. The harness system **MUST** be snugly adjusted.

DO NOT put snowsuits or bulky garments on your child when placing them in the child restraint.

Bulky clothing can prevent the harness straps from being tightened properly.

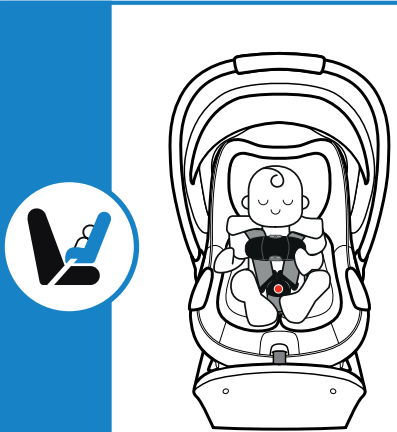

4–30 lb (1.8–13.6 kg) and 32 in. (81.3 cm) or less in height

In this **Rear-Facing** only car seat, your child can use this restraint until they outgrow any one of the following:

- Weight limit: 30 lb (13.6 kg); **OR**
- Height limit: 32 in. (81.3 cm); **OR**
- **Rear-Facing Child Fit Requirements**
PAGE 45

Rear-Facing Use with an Installed Base
PAGE 49

Vehicle Installation without the Base
PAGE 51

WARNING



NEVER install a rear-facing child restraint in the front seat of a vehicle equipped with an active frontal airbag.
DO NOT use the rigid LATCH connectors along with the vehicle lap or lap/shoulder belt.

DO NOT fasten multiple lower anchor connectors on the same lower anchor bar in the vehicle.

Check the vehicle belt or the rigid LATCH connectors before each use.

Use **ONLY** if the belt or rigid LATCH connectors can be tightened properly and locked securely in place.

Even when unoccupied, this child restraint **MUST** be firmly secured to the vehicle with the rigid LATCH connectors or with the vehicle seat belt.

This child restraint **MUST ALWAYS** face the rear of the vehicle.

WARNING

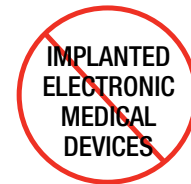

DO NOT use the magnetic chest clip with children who have an implanted electronic medical device.

A magnet is used to help secure the chest clip locking mechanism together which may interfere with the proper function of an implanted electronic medical device.

Parents or caregivers who have an implanted electronic device should keep their device away from the chest clip and consult their doctor and medical device manufacturer for specific information before using this chest clip. If a parent/caregiver or child has an implanted electronic medical device, please contact Dorel (see back cover) for a replacement (non-magnetic) chest clip free of charge.

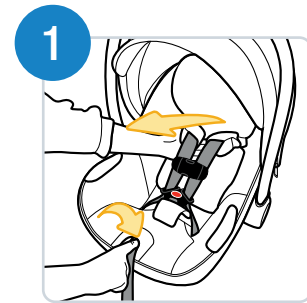

Fully loosen the harness straps

Push down on the harness release lever (through the opening in the seat pad) while pulling the harness straps away from the backrest.

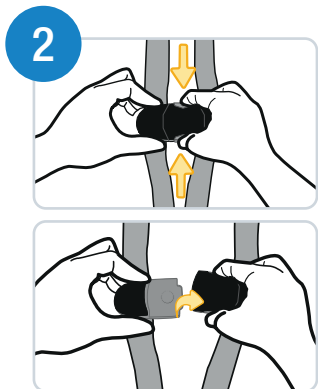

Unfasten the chest clip

Press in on the top and bottom buttons and pull the chest clip apart.

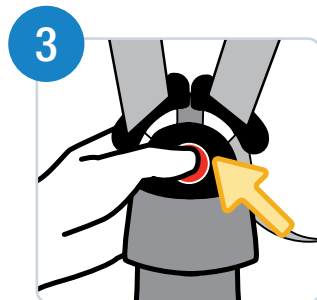

Unbuckle the harness

Press the red button to release the buckle tongues.



Place your child in the car seat to determine the proper harness fit

Your child's bottom and back should be flat against the car seat.

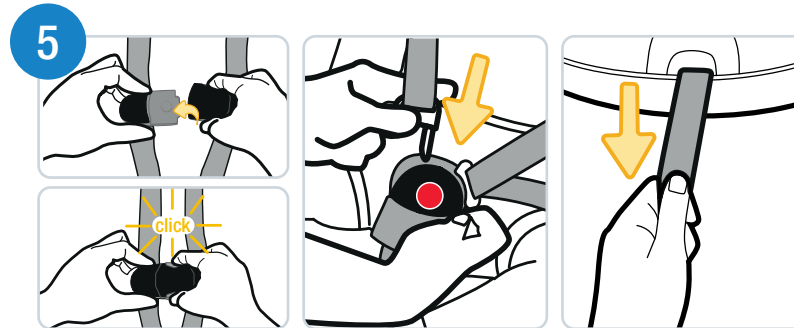

Fasten the chest clip and buckle the harness

Pull the harness adjustment strap straight out to snugly tighten the harness. Position the chest clip mid-chest (even with the armpits) and away from your child's neck.

See *Securing Your Child in the Car Seat* on page 38 for details on chest clip position and checking harness tightness.



Check the head position

The top of your child's head **MUST** be at least 1 in. (2.5 cm) below the top of the car seat's headrest.

To change the headrest position, see page 30.

Rear-Facing Use with an Installed Base

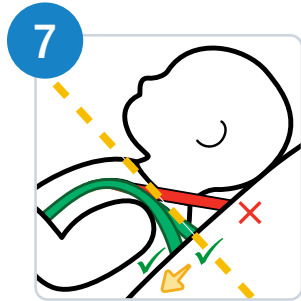

Check the harness strap position

The harness strap **MUST** be placed **at the shoulder** when possible, or slightly below; never above.

To change the harness strap height, see page 30.

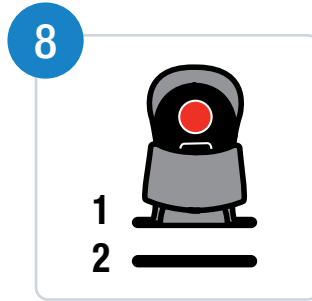

Check the buckle position

- Use the buckle slot closest to your child.
- The buckle strap **should not be underneath or behind** your child.

To change the buckle position, see page 32.

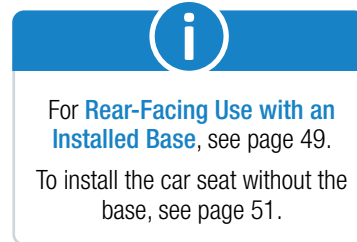

For **Rear-Facing Use with an Installed Base**, see page 49.

To install the car seat without the base, see page 51.



Secure your child in the car seat

For complete details on properly securing your child in the car seat, including how to position the chest clip and check for harness tightness, see pages 38–41.

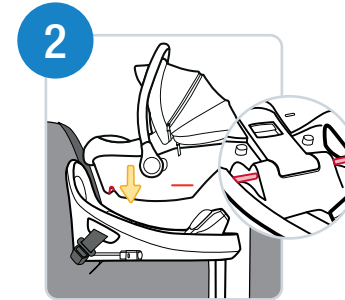

Attach the car seat to the base

Align the slots on the side of the car seat with the lock bars on the base. Push down firmly on the carry handle and front of the car seat until it clicks, locking it in place on the base.

Pull up on the front two corners of the car seat by your child's feet to make sure it is locked to the base.

The carry handle **MUST** be upright and locked when installed in the vehicle.

3

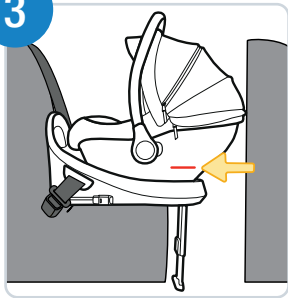

Check the Rear-Facing Level Line

If the **Rear-Facing Level Line** is not parallel to the ground, use the Recline Handle to adjust the angle of the car seat on the base (see page 36).

FINISHED!

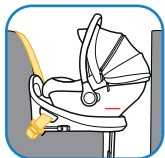

 Lap/Shoulder Belt

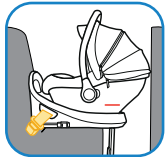

 Lap Belt



 Rigid LATCH Connectors

When using the passenger and driver side locations, the car seat **MUST** be touching the back of the seat in front of it, or be as close as possible.

Is the level line on the car seat parallel to the ground? See step 3.

Check your child's fit often and make any adjustments to the car seat as they grow. Check the tightness of the installation often to make sure it has not loosened.

To remove the car seat from the base, see page 37.

Vehicle Installation Without the Base

There are two methods for installing the car seat without the base in your vehicle. **Use only one:**



Lap/Shoulder Belt

OR



Lap Belt

Before installing the car seat without the base:

- Check whether your vehicle belts will work with this car seat. Not all vehicle belts will work with car seats. Review Vehicle Belts on page 80 and your vehicle owner's manual to determine the type of vehicle belts in your car and how to use them to lock a car seat in place.
- Ensure the vehicle is on level ground when installing the base.

! WARNING



NEVER install a rear-facing child restraint in the front seat of a vehicle equipped with an active frontal airbag.

Check the vehicle belt before each use. Use only if the belt can be tightened properly and locked securely in place.

Even when unoccupied, this child restraint **MUST** be firmly secured to the vehicle with the vehicle seat belt.

This child restraint **MUST ALWAYS** face the rear of the vehicle.

1



Secure your child in the car seat

For complete details on properly securing your child in the car seat, including how to position the chest clip and check for harness tightness, see pages 38–41.

2

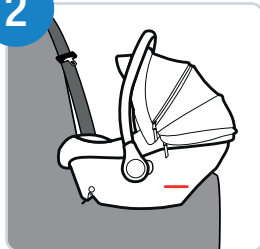

Place the car seat Rear-Facing in the back seat

Center the car seat in the chosen seating position. Make sure the car seat is flat on the vehicle seat and pushed against the vehicle seatback.

The carry handle **MUST** be upright and locked when installed in the vehicle.

3

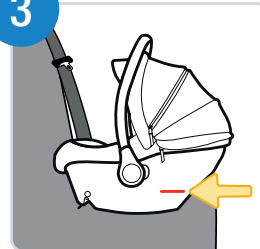

Check the Rear-Facing Level Line

The level line **MUST** be parallel with the ground.

4

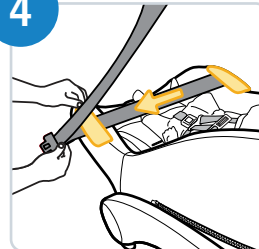

Route the vehicle belt through the belt path guide on the car seat

Insert the lap belt or the lap portion of the lap/shoulder belt under the vehicle belt path guides so that it stretches across your child's lap.

DO NOT twist the belt.

5

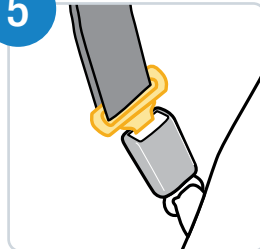

Buckle the vehicle belt

If your vehicle belt has a switchable retractor, make sure it is in locking mode. Refer to page 82 or your vehicle owner's manual.

6

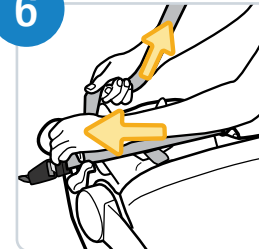

Tighten the vehicle belt

Lay your forearm across the car seat at the belt path while pulling up on the belt to tighten it.

7

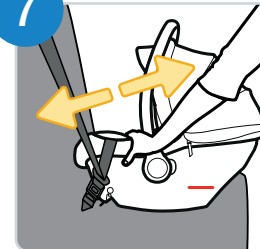

Check the belt tightness

Hold the car seat at the belt path with your non-dominant hand. Push and pull the car seat from side to side. The car seat should not move more than 1 in. (2.5 cm) at the belt path.

If the car seat moves more than 1 in. (2.5 cm), you can try:

- Pulling the belt tighter; **OR**
- Reinstalling the car seat; **OR**
- Changing to a different seating location

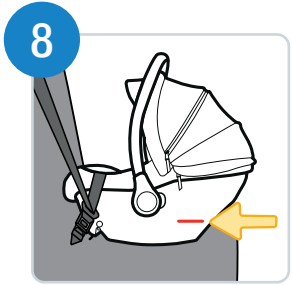

Recheck the Rear-Facing Level Line

The level line **MUST** be parallel with the ground. Redo the installation if necessary.

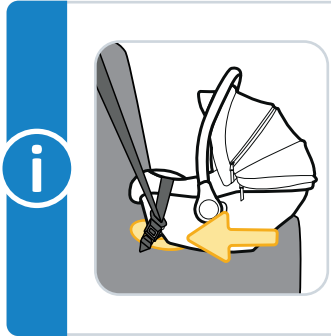

Only if necessary, you may place a tightly rolled towel(s) or foam pool noodle(s) under the front of the car seat base to help make the **Rear-Facing Level Line** parallel with the ground.

Check often to make sure padding is still in place and the belt is tight.

FINISHED!

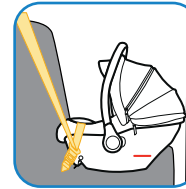

Lap/Shoulder Belt

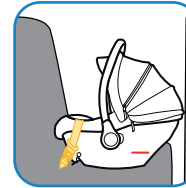

Lap Belt

When using the passenger or driver side locations, the car seat **MUST** be touching the back of the vehicle seat in front of it, or be as close as possible.

- Is the carry handle in the correct position? See step 2.
- Is the vehicle belt buckled and the switchable retractor locked? See step 5.
- Is the belt tightened enough so that the car seat does not move more than 1 in. (2.5 cm) from side to side at the belt path? See steps 6 and 7.
- Is the level line parallel with the ground? See step 8.

Check your child's fit often and make any adjustments to the car seat as they grow.

Adjusting the Buckle Strap for Smaller Infants

Adjusting the Buckle Strap
for Smaller Infants 57

WARNING

The harness system **MUST** be installed correctly. **DO NOT** use a child restraint with damaged harness straps.



The base **MUST** be installed in the vehicle before attaching the car seat. For details on installing the base with a vehicle belt, see page 20. For details on installing the base with rigid LATCH connectors, see page 26.

If you want to use the car seat without the base, see page 51.

1

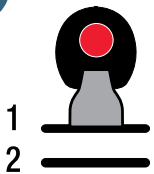

Make sure the buckle is in the first slot

To move the buckle to the first slot, see page 32.

Remove the buckle cover. See page 12.



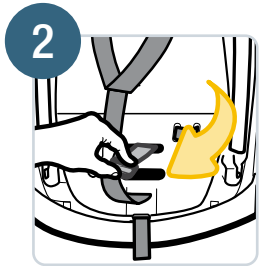

2

Turn the car seat over to move the metal retainer

While keeping the buckle in the first slot, pull the metal retainer towards you and then push it up into the second (front) slot.

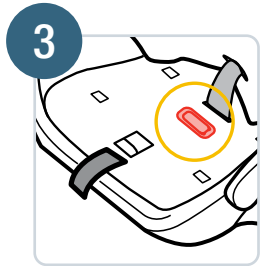

3

Lift up the front of the car seat pad and lay the metal retainer flat against the car seat

Pull the seat pad up from the front of the car seat and around the belt path guides to access the buckle slots. The buckle strap should still be in the first slot while the metal retainer is flat against the car seat in the second slot as shown.



4

Tuck the car seat pad around the front of the car seat and check the buckle

Pull up on the buckle to make sure it is secured. The buckle **MUST NOT** pull out.

Wash and Care

| | |
|---|----|
| Removing the Canopy | 62 |
| Removing the Seat Pad Set for Cleaning | 63 |
| Cleaning the Seat Pad Set and Parts of the Car Seat | 67 |
| Removing and Installing the Harness System | 68 |
| Installing the Seat Pad Set | 75 |
| Installing the Canopy Hoop..... | 78 |

Removing the Canopy



1
Unzip the canopy from the seat pad using the zipper at the bottom of the canopy.

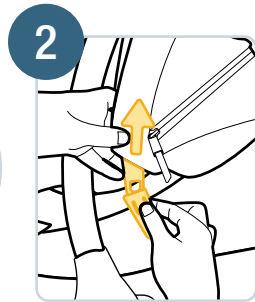

2
Pull back the canopy fabric from the bottom of the canopy hoop just above one of the canopy posts. While pressing the tab on the inner side of the canopy post with one hand, pull the end of the canopy hoop off the post with the other hand.

Repeat on the other side.

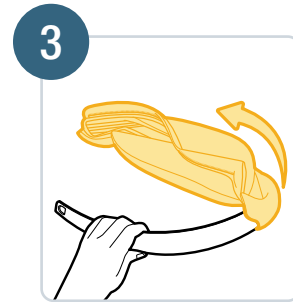

3
Slide the canopy fabric off the canopy hoop.

! WARNING

DO NOT use the child restraint without the seat pad or with damaged harness straps.

Removing the Seat Pad Set for Cleaning

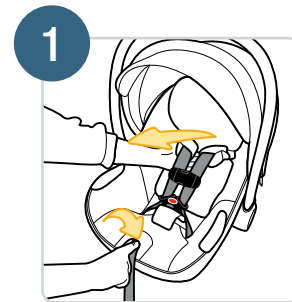

1
Fully loosen the harness straps by pushing down on the harness release lever (through the opening in the seat pad) while pulling the harness straps away from the backrest.

i
You **MUST** remove the canopy before removing the seat pad set. See the previous page.
To remove the head and body pillows, harness covers, and buckle cover, see page 8.

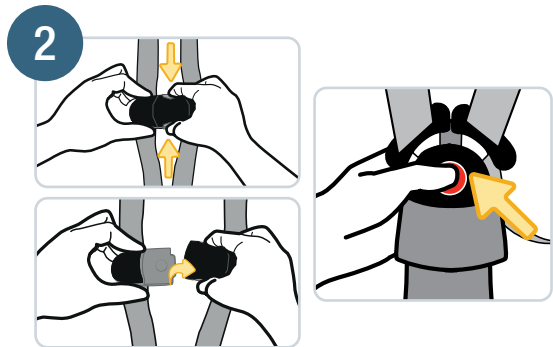

Unfasten the chest clip and press the red button to unbuckle the harness. Pull the harness straps out from the shoulder slots.

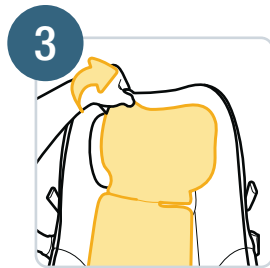

Gently pull the headrest pad off from one side of the headrest and then lift it off the other.



Turn the headrest pad over and remove the foam from the pocket. **DO NOT** wash the foam.

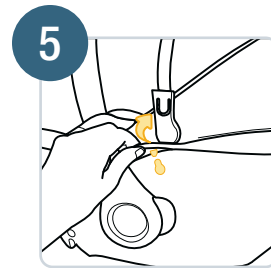

Press down on the peg under the canopy post to slide it out of the slot underneath the seat pad. Repeat with the peg under the other canopy post.

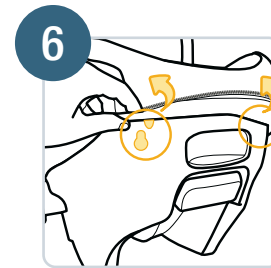

Press down on the peg on the back of the car seat to slide it out of the slot underneath the seat pad. Repeat with the other peg on the back of the car seat.



Unfasten the snap attaching the backrest pad to the side of the seat pad. Repeat on the other side of the backrest pad.



Pull the seat pad down from the top of the seat around the headrest.

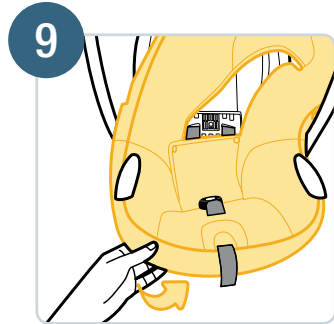

Lift the seat pad off the bottom of the car seat to loosen it around the front.

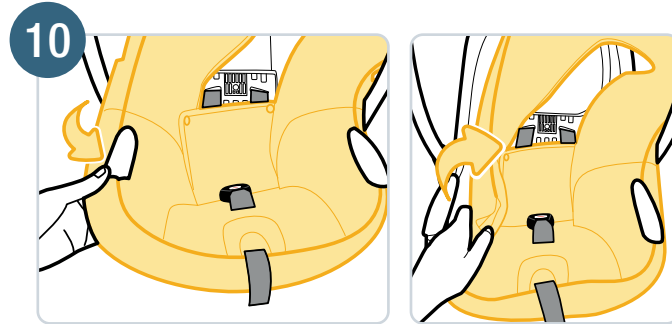

Pull the side of the seat pad down and away from the front of the vehicle belt path guide. Gently pull the remaining fabric from around the back of the belt path guide. Repeat with the fabric around the other belt path guide. Pull the buckle and the harness strap through the seat pad as you pull the remainder of the seat pad off the seat.

To clean the seat pad set and accessories:

Machine wash separately with cold water on gentle cycle. Make sure the foam is removed from the headrest pad before washing the pad (see step 4 on page 62 for how to remove the foam from the headrest pad). **DO NOT** wash the foam. Make sure the harness covers are closed so the fastening strips are not exposed. **DO NOT** use bleach. Tumble dry separately for 10–12 minutes on low heat. Remove immediately.

To clean the harness straps:

Check the harness straps often for wear or damage. Spot clean using warm sudsy water and a damp cloth. Spilled food and liquids on the car seat may result in mold or bacterial growth over time. These spills could also attract insects or rodents.

To clean the buckle and the car seat:

Spot clean using warm sudsy water and a damp cloth. **DO NOT** submerge into water.

To clean the canopy:

Hand wash only using warm sudsy water. Line dry.

WARNING

ONLY remove the foam from the headrest pad when washing the headrest pad. The foam **MUST** be reinstalled in the headrest pad after cleaning and **ALWAYS** used in the car seat. **NEVER** remove any other foam from the car seat or base from cleaning. The removal of any other foam on the car seat or base may result in damage to the car seat or base and can result in serious injury or death to your child, and can result in serious injury or death to your child. Serious injury can include paralysis and/or permanent brain injury.

Removing and Installing the Harness System

WARNING

The harness system **MUST** be installed correctly. **DO NOT** use a child restraint with damaged harness straps.

Removing the Harness System

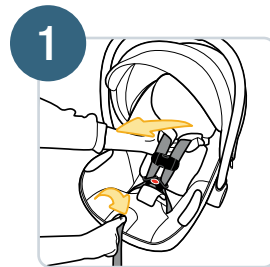

1 Fully loosen the harness straps by pushing down on the harness release lever (through the opening in the seat pad) while pulling the harness straps away from the backrest.

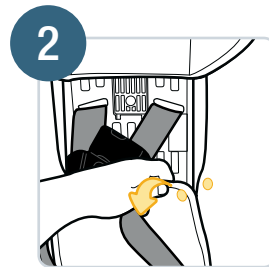

2 Lift up the bottom of the headrest pad and unfasten the snap attaching the backrest pad to the side of the seat pad. Repeat on the other side of the backrest pad.

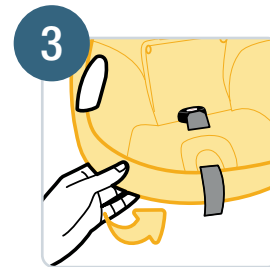

3 Pull the buckle and harness strap through the seat pad as you lift the bottom of the seat pad off the seat.

Lift the seat pad off the bottom of the car seat. Gently pull the sides of the seat pad down and away from the front of the vehicle belt path guides to lift it up over the belt path guides.

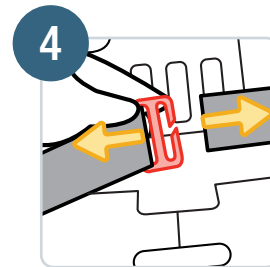

4 Remove the harness strap from the clip under the seat pad. Unloop one side of the harness strap from the clip by pulling it off through the notch in the side on the clip. Repeat to remove the harness strap from the other side of the clip. Set the clip aside for reinstalling the harness straps.



You do not need to remove the harness straps to remove the seat pad set. However, you can partially remove the harness system to spot clean it as described on the previous page or to replace the chest clip or buckle strap.

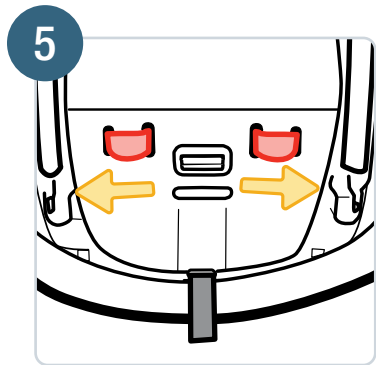

Turn the car seat over. Pull both sides of the harness strap in and out of the bottom of the car seat, turning the car seat back over as needed to pull both sides of the strap through the slots.

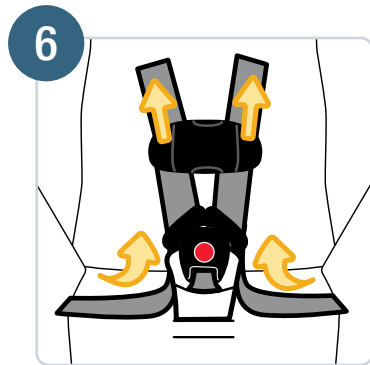

Pull the harness straps out from the buckle and chest clip. The harness straps go through the back of the buckle tongues and then through the chest clip from front to back.

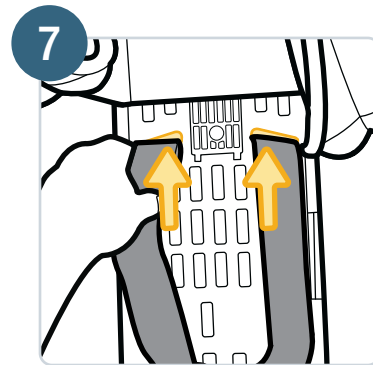

Remove the harness straps from the shoulder slots. Push them through the slots from the front of the car seat and then turn the car seat over to pull them through.

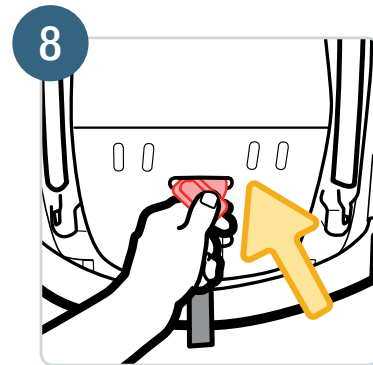

Turn the car seat over. Rotate the metal retainer and push it through the slot in both the car seat and the seat pad.

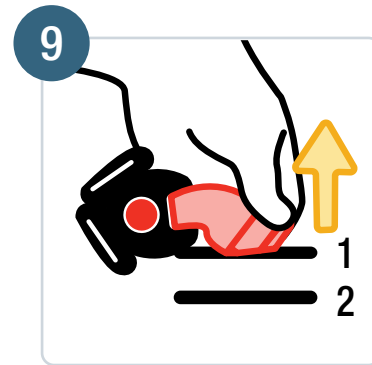

From the top of the car seat, pull the buckle cover out if installed (see page 12 for more details). Pull the buckle out from the slot.

Installing the Harness System



Insert the metal retainer into the slot closest to the child. The buckle **MUST** face out.

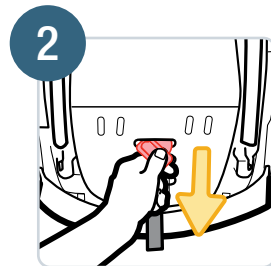

Turn the car seat over and pull the metal retainer completely through the slot in both the seat pad and car seat. Rotate the metal retainer into position.



Turn the car seat back over. Pull up on the buckle to make sure it is secured. The buckle **MUST NOT** pull out.

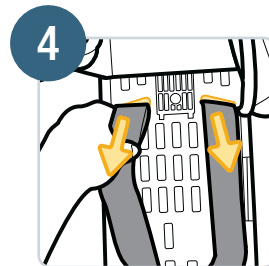

Thread the harness straps through the appropriate shoulder slots from the back of the seat and pull them through the front of the car seat. **DO NOT** twist the harness straps as you insert them into the shoulder slots.

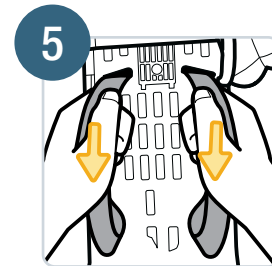

Make sure the harness straps are even in length coming through the shoulder strap. Pull down the shorter side of the strap if needed until both harness straps are the same length.

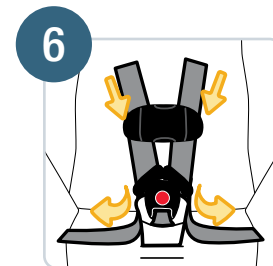

Rethread the harness straps through the buckle and chest clip. The harness strap ends go through the chest clip from front to back and then through the front of the buckle tongues.

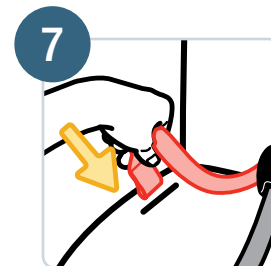

Thread the harness strap down through the hip slot in the car seat. Repeat with the other harness strap

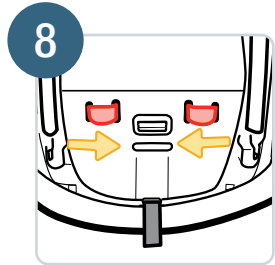

Turn the car seat over. Weave both sides of the harness strap in and out of the bottom of the car seat, turning the car seat back over as needed to pull both sides of the strap through the hip slots on the top of the seat.

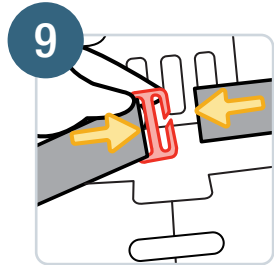

From the front of the car seat, insert one harness strap through the notch on one side of the clip. Repeat with the other harness strap through the opposite side of the clip.

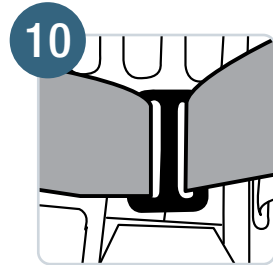

Make sure the clip is in the center of the car seat. Both harness straps should be pulled evenly through the sides of the clip so that the clip lays flat on the car seat.

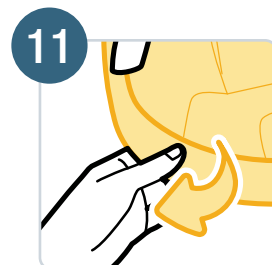

Pull the seat pad around the vehicle belt path guides and the front of the seat, working from front to back. Fasten the snaps on the backrest pad (see Installing the Seat Pad Set on page 76 for more details).

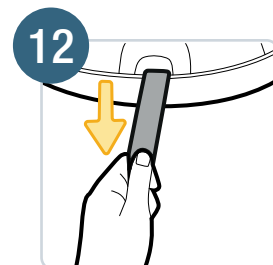

Pull the harness adjustment strap straight out to tighten the harness. Slide the chest clip up or down as needed.



For **Rear-Facing Child Fit Requirements**, see page 45.

To check harness tightness, see pages 38–41.

Installing the Seat Pad Set

⚠ WARNING

DO NOT use the child restraint without the seat pad or with damaged harness straps.

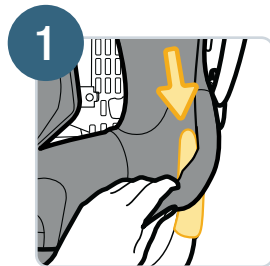

Pull the side of the seat pad around the vehicle belt path guide, working from back to front. Tuck it completely around the belt path guide. Repeat with the other belt path guide.

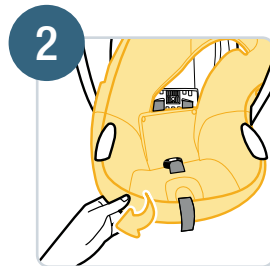

Pull the harness adjustment strap through the front of the seat pad and the buckle through same slot as the car seat. Tuck the seat pad around the front of the car seat.



Pull the openings on both sides of the seat pad around the canopy posts.

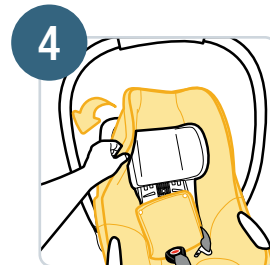

Gently pull the seat pad up around the headrest and tuck it around the top of the car seat.

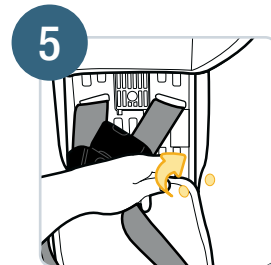

Fasten the snap on the top of backrest pad to the side of the seat pad. Repeat with the snap on the other side of the backrest pad.

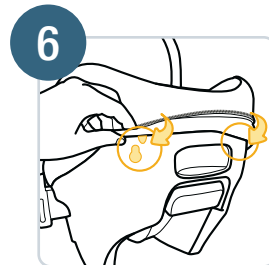

Slide both pegs on the underside of the seat pad into the slots on the back of the car seat. Press down on both pegs to fasten.

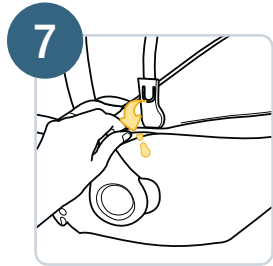

Slide both pegs on the underside of the seat pad into the slots below each canopy post. Press down on both pegs to fasten.

WARNING

The foam **MUST** be used with the headrest pad. **ALWAYS** reinstall the foam properly after cleaning the headrest pad. Using the headrest pad without the foam can result in serious injury or death to your child. Serious injury can include paralysis and/or permanent brain injury.



Insert the headrest foam into the headrest pad as shown. The flat side of the foam **MUST** face the plastic portion of the headrest once installed. The thin section of the foam should be positioned between the harness slots. Close the pocket over the foam.

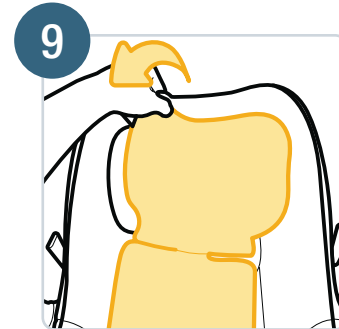

Pull the headrest pad over the headrest. Tuck it completely around the sides and top of the headrest. Make sure the headrest pad is tucked around the headrest adjustment handle.

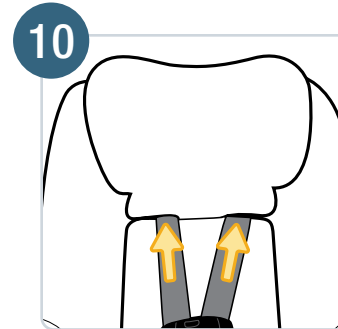

Slide the harness straps into both shoulder slots in the headrest pad. To install the canopy, see the next page. To install accessories, see page 8.

Installing the Canopy Hoop



1 Slide the canopy fabric onto the canopy hoop oriented as shown with the canopy visor pointed up. Continue to slide the canopy fabric around the hoop until the hoop comes through the pocket on the other end.

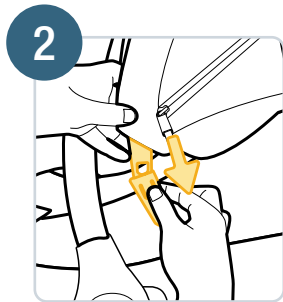

2 Insert the end of the canopy hoop onto the canopy post until the tab pops out and it is secured in place. Repeat on the other side.

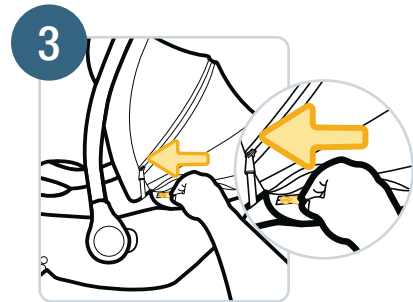

3 Zip the canopy around the back of the seat pad.

Vehicle Belt and LATCH Information

| | |
|--------------------------------|----|
| Vehicle Belts | 80 |
| LATCH: Lower Anchor Bars | 84 |

Vehicle Belts

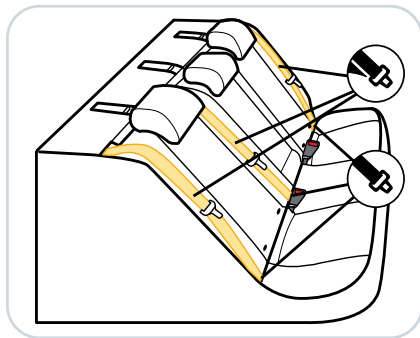

Your vehicle's features may be considerably different than those pictured here.

If LATCH: lower anchors are not an option in your vehicle, you **MUST** use the vehicle seat belt system to install the car seat.

Not all vehicle belts and seating positions will work with car seats. Follow the steps in this section to learn how to lock a car seat in Rear-Facing Mode with a vehicle belt.

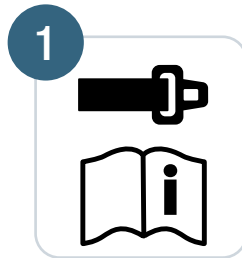

You MUST review your vehicle owner's manual.

Review your vehicle owner's manual to determine the type of vehicle belts in your car and the seating positions available for installing a car seat.



Check how this car seat can be locked into place with the vehicle belt

The vehicle belt **MUST NOT** loosen after tightening it. This requires locking it by using:

- The base lockoff (see step 3) **AND**
- The vehicle belt's retractor (see step 4) **OR**
- The vehicle belt's latch plate (see step 5)



Install the base with the lockoff

When used correctly, the lockoff on the base will lock the vehicle belt. However, you **MUST** also lock the vehicle belt using the retractor or latch plate.

Refer to page 20 for installing the base with the lockoff and then use either the retractor or latch plate as described in steps 4 and 5.

If you are installing the car seat without the base, you **MUST** lock the vehicle belt using the retractor or latch plate. Continue to the next step.

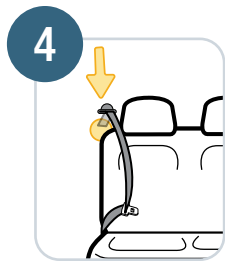

Check the retractor on your vehicle belts

Retractors pull vehicle belts into stored positions and lock the belt to hold passengers in place. The following retractors will work with this car seat:

- **Switchable retractor (most vehicles have this type).** This retractor can be manually switched to a locking mode. Your retractor **MUST** be in this locking mode to use the vehicle belt with this car seat.

To switch to locking mode:

1. Slowly pull the shoulder belt all the way out and then let it go back into the retractor 1–2 in. (2.5–5 cm).
2. As it retracts, you will likely hear a ratcheting sound.
3. Gently pull the belt to see if it has locked. You will not be able to pull any more of the belt out once the lock has engaged.

- **Automatic locking retractor.** This retractor always locks. It will automatically lock after slowly pulling the shoulder belt out at least halfway and letting it go back into the retractor 1–2 in. (2.5–5 cm).

Emergency locking retractor

If the retractor does not lock, it is likely an emergency locking retractor. This retractor only locks during a sudden stop or collision. Continue to step 5 to determine if your vehicle belt's latch plate can lock the belt.

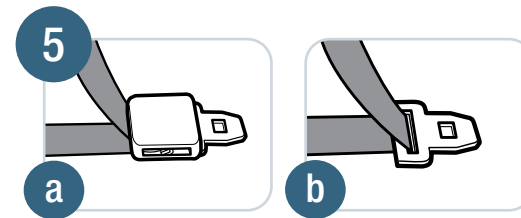

Check the latch plates on your vehicle belts

Latch plates are the part of the vehicle belt that goes into the buckle.

To check if the latch plate locks:

1. Buckle the vehicle belt.
2. Slowly pull up on the lap portion of the vehicle belt.



NEVER use the following with this car seat:

- Emergency locking retractor lap-only belt
- Inflatable seat belts

- a. If the vehicle belt does not slide through the latch plate, it's locked. You can use the locking latch plate with this car seat.
- b. If the vehicle belt slides through the latch plate, it is a sliding latch plate. Sliding latch plates easily slip between the lap and shoulder portions of the belt.

LATCH: Lower Anchor Bars

The lower anchors of **LATCH** (**L**ower **A**nchors and **T**ethers for **C**hildren) is a universal system for installing car seats without using vehicle seat belts. The rigid LATCH connectors can **ONLY** be used in vehicles that have the lower anchor bars installed in designated seating positions. Most vehicles manufactured after September 2002 are equipped with LATCH: lower anchor bars. Check your vehicle owner's manual to see which seating positions may be equipped with LATCH: lower anchor bars. Rigid LATCH connectors cannot be used with raised LATCH anchors in the vehicle seatback.

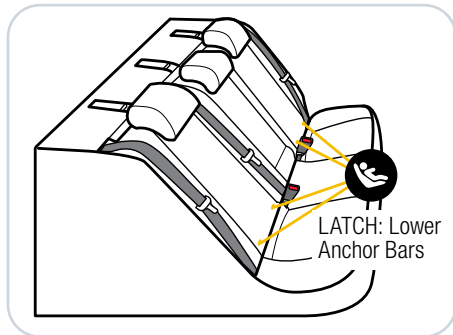

Your vehicle's features may be considerably different than those pictured here.

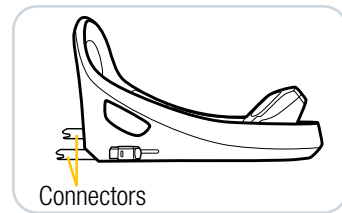
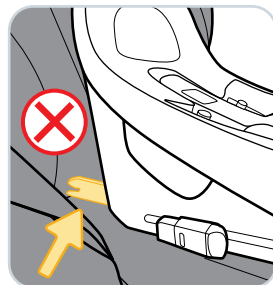

To install the base with rigid LATCH connectors, see page 26.

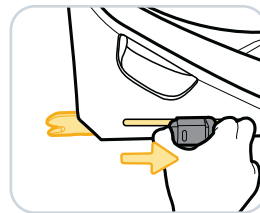

To remove rigid LATCH connectors from the vehicle anchors:

Push to tilt the release lock tab backwards and then push in the release button on the other end to slide the release lock toward the front of the base until the connector fully retracts into the base. Repeat on the other side.

! WARNING

DO NOT use both the rigid LATCH connectors and vehicle belt at the same time.

Safety Information

- Child Restraint Use..... 87
- Vehicle Seating Position 88
- Installation in Vehicle..... 89
- Replacement and Expiration 90
- Registration and Safety Notices 91
- Aircraft Information..... 92
- Warranty 93
- Replacement Parts 95

WARNING

- NEVER** take your child out of the child restraint while the vehicle is moving.
 - NEVER** leave your child unattended. Placing your child in a hot child restraint may result in burns.
 - DO NOT** use a child restraint with damaged or missing parts.
 - DO NOT** use a child restraint with cut, frayed, or damaged harnesses.
 - DO NOT** substitute parts or try to modify the child restraint in any way. **DO NOT** lubricate buckles and fasteners.
 - DO NOT** use any child restraint accessory except those approved by Dorel Juvenile Group.
 - NEVER** allow any child to play with this child restraint; it is not a toy.
 - DO NOT** remove or cover up any of the warning labels or other labels on the child restraint.
- This child restraint has been certified for use in passenger vehicles. **DO NOT** use in a boat, on a motorcycle, or in a cargo van or bus where there are no seat belts or tether anchors.
- When installing with a base, only use this car seat with a compatible Maxi-Cosi Infant Car Seat Base.
- Read all instructions for additional warnings.



WARNING



NEVER place a child rear-facing in a seating position with an active frontal air bag.

Check the vehicle owner's manual for more information about air bag/child restraint use.



Use the child restraint only on vehicle seats that face forward.



DO NOT use on seats that face the sides or rear of the vehicle.

For vehicles without a back seat, refer to your vehicle owner's manual.



According to accident statistics, children are safer when properly restrained in the rear seating positions than in the front seating positions.

Rear seating positions are statistically safer, whether you have air bags, advanced air bags, or no air bags at all.

If you are not sure where to place the car seat in your vehicle:

- Consult your vehicle owner's manual; **OR**
- Contact Dorel Juvenile Group Consumer Care Department; **OR**
- Visit your local Child Passenger Inspection Station. Go to <https://www.nhtsa.gov/vehicle-safety/car-seats-and-booster-seats> to find your closest station.

To avoid your child being seriously burned, take the following precautions:

- Park in the shade or where the sun does not directly hit the car seat.
- Cover the car seat with a sheet or blanket when not in use.
- Check for hot seat and buckles before placing child in car seat.

To help protect your vehicle seat's upholstery from damage: You may use an accessory approved by Dorel Juvenile Group or a single layer towel underneath and behind car seat.

WARNING

Check the vehicle belt or rigid LATCH before each use. Use only if the belt can be tightened properly and locked securely in place.

Even when unoccupied, this child restraint **MUST** be firmly secured to the vehicle with the rigid LATCH or with the vehicle seat belt.

In a crash or sudden stop, an unsecured child restraint could injure occupants.

Replacement and Expiration

DO NOT risk your child's safety.

To keep your child as safe as possible, Dorel Juvenile Group strongly recommends replacing the car seat even after a minor crash, even if it was not occupied at the time.

Replacement After a Minor Crash

The National Highway Traffic Safety Administration states that for a crash to be considered minor **ALL of the following MUST be true:**

- Vehicle able to drive away from the crash site; **AND**
- Vehicle door nearest the car seat was not damaged; **AND**
- No passengers were injured; **AND**
- Airbags did not deploy; **AND**
- There is no visible damage to the car seat.

If the crash your car seat was involved in meets **ALL** the criteria, you may not need to replace the car seat.

If one or more of these criteria are not true or if you are uncertain of any of your answers, replace the car seat immediately.

Replacement After a Moderate to Severe Crash

You **MUST** replace this car seat if it has been in a moderate to severe car crash.

This car seat is intended to protect a child in a single crash. During a crash, the car seat and all of its parts absorb crash energy which can deform or weaken it. Damage is not always visible. A damaged car seat **MUST** be replaced immediately.

Expiration

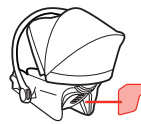

On the side of the car seat, there is a date of manufacture label as shown.

DO NOT use this car seat more than 8 years after the date of manufacture.

Please complete the postage-paid registration card that came with your child restraint, and send it to us.

Child restraints could be recalled for safety reasons.

You must register this restraint to be reached in a recall.

Send your name, address, email address if available, and the restraint's model number and manufacturing date to:

Dorel Juvenile Group

P.O. Box 2609
Columbus, IN 47202

or call 1-800-544-1108 or register online at www.djgusa.com/registration/carseat/us.

For recall information, call the U.S. Government's Vehicle Safety Hotline at 1-888-327-4236 (TTY: 1-800-424-9153), or go to www.NHTSA.gov.

Registration and Safety Notices

0515079 Tear Off and Mail This Part or Register Online 4348-0081D

Consumer: Just fill in your name, address and email. Please print (use dark ink).

Your Name

Your Street Address

City State Zip Code

Email Address (optional)

| Model Number | Model Name | Manufacture Date |
|--------------|---------------|------------------|
| AB123CDE | BRAND CARSEAT | 2024/05/01 |

L#11 B265035

Example of model number, manufacture date, and line code.

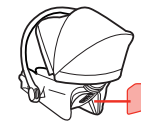

If you don't have the card or if your address changes, you will find the model number, manufacture date, and line code on the label located on the side of the car seat.

This restraint is certified for aircraft use.



Rear-Facing Aircraft Installation

Follow the steps for vehicle belt installation without the base on pages 51–55.

Install the car seat in a window seat to avoid blocking the aisle. If the aircraft lap belt is too short, ask the flight attendant for a belt extender.

Use only on forward-facing aircraft seats. Contact the airline for their specific policies.

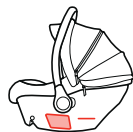

Some airlines may ask to see a label stating that this car seat is certified for aircraft use. There is an airplane certification label located on the side of this car seat as shown.

Dorel Juvenile Group, Inc. (DJG) warrants this product to the original retail purchaser as follows: This product is warranted against defective materials or workmanship for one year from the date of original purchase. An original receipt is required to validate your warranty. DJG will, at its option, provide replacement parts or replace this product. DJG reserves the right to substitute if the part or model has been discontinued.

To make a claim under this warranty contact our Consumer Care Department by phone at 1-800-544-1108; or text us at 1-812-652-2525. Our hours of operation are from 8:00 a.m. to 6:00 p.m. EST Monday through Thursday and from 8:00 a.m. to 4:30 p.m. on Friday.

Proof of purchase is required and shipping charges are the responsibility of the consumer.

Warranty Limitations: This warranty does not include damages which arise from misuse or abuse of this product.

Limitation of Damages: The warranty and remedies as set forth are exclusive and in lieu of all others, oral or written, expressed or implied. In no event will DJG or the dealer selling this product be liable to you for any damages, including incidental or consequential damages, arising out of the use or inability to use this product.

Limitation of warranties and other warranty terms and state law rights: Any implied warranties, including implied warranties of the merchantability and fitness for a particular purpose, shall be limited to the duration and terms of the express written warranty. Some states do not allow limitations as to how long an implied warranty lasts or the exclusion or limitation of incidental or consequential damages, so the above limitations may not apply to you.

This warranty gives you specific legal rights, and you may have other rights, which vary from state to state. Neither DJG nor the dealer selling this product authorized any person to create for it any other warranty, obligation, or liability in connection with this product.

Please note: Our product warranty only applies when purchased from an authorized Maxi-Cosi retailer. The origin of products not purchased through these authorized retailers is unknown and could be counterfeit.

We cannot support products from an unknown origin as we cannot verify the handling or condition of such merchandise. We maintain a strong network of authorized retailers to ensure you are purchasing safe and complete products.

Fulfillment by a third party does not guarantee you are purchasing from one of these authorized retailers.

Pricing which is inconsistent with the majority of retailers is a strong indication that the retailer is not authorized, as we have a consistent price offering across all authorized retailers.

If you are unsure of the authorization status of a retailer you are considering purchasing from, or have purchased from, you can check www.maxicosi.com/us-en/shops.aspx; or call our Consumer Care Department at 1-800-544-1108; or text us at 1-812-652-2525.

For parts availability and questions, call, text, email, or chat. See the Consumer Care contact information on the back cover of this manual.

If the requested color is not available, a similar color will be substituted.

Applicable tax and shipping & handling will also be added.

- Chest Clip
- Buckle Assembly
- Seat Pad Set
- Canopy Hoop
- Base
- Instructions