

Gas Slide-in Range

User manual

NSG90*60****

- For detailed instructions on installation and cleaning of the appliances, visit the Samsung website (<http://www.samsung.com>), go to Support > Support home, and then enter the model name.
- To check the product's model name, see the label enclosed with the product or attached to the product.
- Open a QR code scanner app and scan the QR code image attached to the product. You can access 'Product registration', 'Manual', and 'Customer support'.
- Figures and illustrations are provided for reference only and may differ from the actual product appearance. Product design and specifications may change without notice.
- Your range's model number is found behind the storage/warming drawer, or bottom of the control panel.

SAMSUNG

WARNING

Never Operate the Top Surface Cooking Section of this Appliance Unattended.

- **Failure to follow this warning statement could result in fire, explosion, or burn hazard that could cause property damage, personal injury, or death.**
- **If a fire should occur, keep away from the appliance and immediately call your fire department.**

DO NOT ATTEMPT TO EXTINGUISH AN OIL/GREASE FIRE WITH WATER.

WARNING: If the information in this manual is not followed exactly, a fire or explosion may result causing property damage, personal injury, or death.

- **DO NOT** store or use gasoline or other flammable vapors and liquids in the vicinity of this or any other appliance.
- **WHAT TO DO IF YOU SMELL GAS:**
 - **DO NOT** try to light any appliance.
 - **DO NOT** touch any electrical switch.
 - **DO NOT** use any phone in your building.
 - Immediately call your gas supplier from a neighbor's phone. Follow the gas supplier's instructions.
 - If you cannot reach your gas supplier, call the fire department.
- Installation and service must be performed by a qualified installer, service agency, or the gas supplier.

ANTI-TIP DEVICE

WARNING

To reduce the risk of tipping the range, the range must be secured by a properly installed Anti-Tip device. **AFTER THE RANGE HAS BEEN INSTALLED, CONFIRM THAT THE ANTI-TIP DEVICE HAS BEEN PROPERLY INSTALLED AND VERIFY THAT THE ANTI-TIP DEVICE IS PROPERLY ENGAGED.** Refer to the installation manual for instructions.

- a) If the Anti-Tip device is not installed, a child or adult can tip the range and be killed.
- b) Verify the Anti-Tip device has been properly installed and engaged at right rear (or left rear) of the range bottom.
- c) If you move the range and then move it back into place, ensure the Anti-Tip device is re-engaged at the right or left rear of the range bottom.
- d) Do not operate the range without the Anti-Tip device in place and engaged.
- e) Failure to do so can result in death or serious burns to children or adults.



WARNING

Do not step, lean, or sit on the oven door of the range. You can cause the range to tip, resulting in burns or serious injuries.

Confirm that the Anti-Tip device is installed properly. Then, to verify that the Anti-Tip device is engaged, grasp the top rear edge of the range and carefully attempt to tilt it forward. The Anti-Tip device should prevent the range from tilting forward more than a few inches.

If you pull the range out from the wall for any reason, make sure the Anti-Tip device is properly engaged when you push the range back against the wall. If it is not, there is a risk of the range tipping over and causing injury if you or a child stand, sit, or lean on an open door.

Never completely remove the leveling legs. If you remove the leveling legs, the range will not be secured by the Anti-Tip device properly.

Contents

| | |
|---|-----------|
| Safety Information | 6 |
| Safety information | 6 |
| Important safety symbols | 6 |
| Read all instructions before using this appliance | 6 |
| General safety | 7 |
| Fire safety | 8 |
| Gas safety | 8 |
| Electrical and grounding safety | 9 |
| Installation safety | 10 |
| Location safety | 11 |
| Cooktop safety | 12 |
| Oven safety | 14 |
| Storage drawer safety | 15 |
| Self-cleaning oven safety | 15 |
| California Proposition 65 Warning | 17 |
| Commonwealth of Massachusetts | 17 |
| Key features | 17 |
| At a Glance | 18 |
| Overview | 18 |
| Layout | 18 |
| What's included | 19 |
| Control panel | 20 |
| Smart Features | 21 |
| Before you start | 21 |
| Clock | 21 |
| Oven vent/cooling vent | 21 |
| Cooktop | 22 |
| Ignition | 23 |
| Cookware | 25 |
| Wok grate | 26 |
| Griddle | 27 |
| Gas oven | 28 |
| Using the oven racks | 29 |
| Cooking mode | 31 |
| Recipe guide | 35 |
| Air Fry Max mode | 36 |
| Air Sous Vide mode | 39 |
| Temperature probe | 41 |
| Cooking options | 43 |
| Timer | 43 |

| | |
|---|-----------|
| Special features | 46 |
| Changing settings | 50 |
| Smart control | 55 |
| Voice control | 57 |
| Cleaning and Maintenance | 58 |
| Maintenance | 58 |
| Cleaning | 58 |
| Self-cleaning | 65 |
| Replacing the oven light | 68 |
| Removing and reinstalling the oven door | 69 |
| Troubleshooting | 72 |
| Information codes | 78 |
| Appendix | 79 |
| Warranty (U.S.A) | 79 |
| Warranty (CANADA) | 81 |
| Appendix | 83 |
| Open Source Announcement | 83 |

Safety information

- Congratulations on your new Samsung appliances. This manual contains important information on the installation, use, and care of your appliances. Read this manual thoroughly before using the appliances to ensure that you know how to safely and efficiently operate the features and functions that your new appliances offers.

Important safety symbols

What the icons and signs in this user manual mean:

WARNING

Hazards or unsafe practices that may result in **severe personal injury, death and/or property damage.**

CAUTION

Hazards or unsafe practices that may result in **personal injury and/or property damage.**

Read the instructions

After reading this manual, store it in a safe place for future reference.

Read all instructions before using the appliance.

NOTE

Useful tips and instructions.

These warning icons and symbols are here to prevent injury to you and others. Please follow them explicitly. After reading this section, keep it in a safe place for future reference.

Read all instructions before using this appliance

- All electrical and gas equipment with moving parts can be dangerous. Please read the important safety instructions for this appliance in this manual. The instructions must be followed to minimize the risk of injury, death, or property damage.
- Save this manual. Please Do Not Discard.

General safety

WARNING

To reduce the risk of fire, electric shock, personal injuries, and/or death, observe the following precautions.

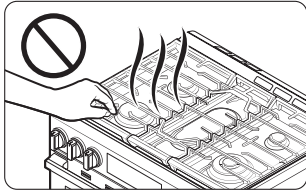

- **Do not touch** any part of the range, including but not limited to, oven burners, surface burners, or interior surfaces during or immediately after cooking.
 - **Know** the location of the gas shut-off valve and how to shut it off.
 - **Make sure** the **Anti-Tip device** is properly installed on the range. See the installation instructions for more information.
- **Do not let children near** the range. Do not let children go into the range or onto the range. Do not let children play with the range or any part(s) of the range. Do not leave children unattended in an area where the range is in use. For children's safety, we recommend utilizing the control/door lockout feature.
 - **Remove** all packaging materials from the range before operating to prevent ignition of these materials. Keep all packaging materials out of children's reach. Properly dispose the packaging materials after the range is unpacked.
 - **Do not store** any object of interest to children on the cooktop or backguard of the range. Children climbing on the range to reach items could be killed or seriously injured.
 - **Do not operate** the range if the range or any part of the range is damaged, malfunctioning, or missing parts.
 - **Do not use** the range as a space heater. Use the range for cooking only.
 - **Do not use** oven cleaners or oven liners in or around any part of the oven.
 - **Use** only dry pot holders. Pot holders with moisture in them can release steam and cause burns if they come in contact with hot surfaces. Keep pot holders away from open flames when lifting cookware. **Never use** a towel or bulky cloth in place of a pot holder.
 - **Do not use** the range to heat unopened food containers.
 - **Do not strike** the oven glass.
 - When disposing of the range, **cut off** the power cord and **remove** the door to prevent children and animals from getting trapped.
 - **Unplug or disconnect** power before servicing.
 - **Make sure** all meat and poultry is cooked thoroughly. Meat should always be cooked to an internal temperature of 160 °F (71 °C). Poultry should always be cooked to an internal temperature of 180 °F (82 °C).
 - Do not make any attempt to operate the electric ignition oven during an electrical power failure.
 - Keep the appliance area clear and free of combustible materials, gasoline, and other flammable vapors and liquids.
 - **Teach** children not to touch or play with the controls or any part of the range. We recommend you utilize the control / door lockout feature to reduce the risk of misuse by children.
 - **Do not lean** on the range as you may turn the control knobs inattentively.
 - **Do not stand** on top of the appliance or place objects (such as laundry, an oven cover, lighted candles, lighted cigarettes, dishes, chemicals, metal objects, etc.) on the appliance.
 - Items, such as a cloth, may get caught in the door.
 - This may result in electric shock, fire, problems with the product, or injury.

Safety information

- Take care not to hurt yourself when cleaning the appliance (externally or internally). You may hurt yourself on the sharp edges of the appliance.
- The range can get hot while in use, so for safety reasons, children or people who are not good at handling should not use it alone.
- If a pet touches the operator, the product may operate unintentionally, so be careful not to allow the pet to access the product.

Fire safety

WARNING

To reduce the risk of fire, electric shock, personal injuries, and/or death, observe the following precautions.

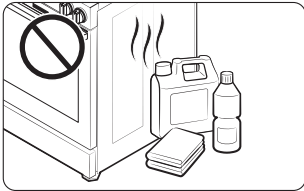

- **Do not store, place or use** flammable or combustible materials such as charcoal, paper, plastic, pot holders, linens, curtains, gasoline or other flammable vapors or liquids near or inside the range.
 - **Do not wear** loose fitting or hanging garments while using the range.
 - To avoid grease buildup, **regularly clean** the vents.
- **Do not let** pot holders or other flammable materials touch a heating element. Do not use a towel or other bulky cloths in place of a pot holder.
 - **Do not use** water on a grease fire. To put out a grease fire, turn off the heat source and smother the fire with a tight-fitting lid or use a multipurpose dry chemical or foam-type fire extinguisher.
 - If a grease fire should occur in the oven, **turn off the oven** by pressing the **Stop** pad. **Keep** the oven door closed until the fire goes out. If necessary, **use a** multipurpose dry chemical or foam-type **fire extinguisher**.
 - **Do not heat** unopened food containers. The buildup of pressure may cause the containers to burst and result in injury.
 - **NEVER use** this appliance as a space heater to heat or warm the room. Doing so may result in carbon monoxide poisoning and overheating of the oven. Do not use the oven for storage. Paper and other flammable items stored in the oven can ignite.
 - **Do not** leave items such as paper, cooking utensils or food in the oven when not in use. Items stored in an oven can ignite.
 - **Do not put** any combustible material or items around the range.

Gas safety

WARNING

To reduce the risk of fire, electric shock, personal injuries, and/or death, observe the following precautions.

If you smell gas:

- **Close the valve** and do not use the range.
- **Do not light** a match, candle, or cigarette.
- **Do not turn on** any gas or electric appliances.

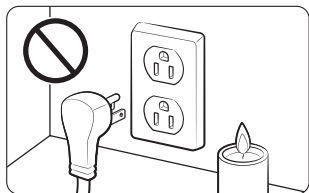

- **Do not touch** any electrical switches or plug a power cord into an outlet.
- **Do not use** any phone in your building.
- **Evacuate** the room, building, or area of all occupants.
- **Immediately call** your gas supplier from a neighbor's phone. Follow the gas supplier's instructions.
- If you cannot reach your gas supplier, call the fire department.

Checking for gas leaks

Leak testing of the appliance must be conducted according to the manufacturer's instructions. **Do not use** a flame to check for gas leaks. Use a brush to spread a soapy water mixture around the area you are checking. If there is a gas leak, you will see small bubbles in the soapy water mixture at the leak point.

Electrical and grounding safety

WARNING

To reduce the risk of fire, electric shock, personal injuries, and/or death, observe the following precautions.

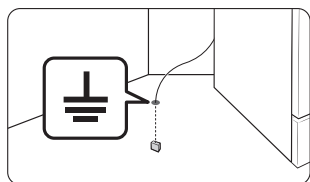

- Plug the range into a grounded 3-prong outlet.
 - **Do not remove** the ground prong.
 - **Do not use** an adapter or an extension cord.
 - **Do not use** a damaged power plug, power cord, or loose power outlet.
 - **Do not modify** the power plug, power cord, or power outlet in any way.
- **Do not put** a fuse in a neutral or ground circuit.
 - Use a dedicated 120-volt, 60-Hz, 20-amp, AC electrical circuit with a time-delay fuse or circuit breaker for this range. Do not plug more than one appliance into this circuit.
 - **Do not connect** the ground wire to plastic plumbing lines, gas lines, or hot water pipes.
 - This range **must be Earth grounded**. In the event of a malfunction or breakdown, grounding will reduce the risk of electrical shock by providing a path for the electric current. This range is equipped with a cord having a grounding plug. The plug must be firmly plugged into an outlet that is properly installed and grounded in accordance with the local codes and ordinances. If you are unsure whether your electrical outlet is properly grounded, have it checked by a licensed electrician.
 - The range is supplied with a 3-pronged grounded plug. This cord must be plugged into a mating, grounded 3-prong outlet that meets all local codes and ordinances. If codes permit the use of a separate ground wire, we recommend that a qualified electrician determine the proper path for this ground wire.
 - Electrical service to the range must conform to local codes. Barring local codes, it should meet the latest ANSI/NFPA No. 70 – Latest Revision (for the U.S.) or the Canadian Electrical Code CSA C22.1 – Latest Revisions.
 - It is the personal responsibility of the range owner to provide the correct electrical service for this range.

Safety information

Installation safety

WARNING

To reduce the risk of fire, electric shock, personal injuries, and/or death, observe the following precautions.

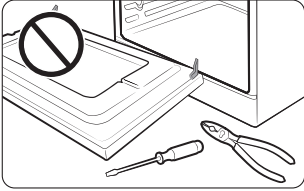

- Have your range installed and properly grounded by a **qualified installer**, in accordance with the installation instructions. Any adjustment and service should be performed only by qualified gas range installers or service technicians.
 - **Do not attempt** to service, modify, or replace your range or any part of your range unless it is specifically recommended in this manual. All other service should be referred to a qualified technician.
-
- Always use new flexible connectors when installing a gas appliance. **Do not use** old flexible connectors.
 - **Make sure** the Anti-Tip device is properly installed on the range. See the installation instructions for more information.
 - Due to the size and weight of the range, have **two or more people** move the range.
 - **Remove** all tape and packaging materials.
 - **Remove** all accessories from the cooktop, oven, and/or lower drawer. Grates and griddles are heavy. Use caution when handling them.
 - **Make sure** no parts came loose during shipping. Do not install in an area exposed to dripping water or outside weather conditions.
 - **Make sure** your range is correctly installed and adjusted by a qualified service technician or installer for the type of gas (natural or LP) you will use. For your range to utilize LP gas, the installer must replace the 5 surface burner orifices and 2 oven orifices with the provided LP orifice set, and reverse the GPR adapter. These adjustments must be made by a qualified service technician in accordance with the manufacturer's instructions and all codes and requirements of the authority having jurisdiction. The qualified agency performing this work assumes the gas conversion responsibility.
 - Installation of this range must conform with local codes or, in the absence of local codes, with the National Fuel Gas Code, ANSI Z223.1/NFPA.54, latest edition. In Canada, installation must conform with the current Natural Gas Installation Code, CAN/CGA-B149.1, or the current Propane Installation Code, CAN/CGA-B149.2, and with local codes where applicable. This range has been design-certified by ETL according to ANSI Z21.1, latest edition, and Canadian Gas Association according to CAN/CGA-1.1, latest edition.

Location safety

WARNING

To reduce the risk of fire, electric shock, personal injuries, and/or death, observe the following precautions.

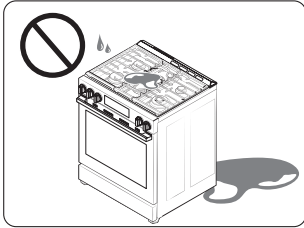

- This range is for indoor, household use only. **Do not install** the range in areas exposed to the weather and/or water.
- **Do not install** the range in a place which is exposed to a strong draft.
- Select a level, well-constructed floor that can support the range's weight. Synthetic flooring, such as linoleum, must withstand 180 °F (82 °C) temperatures without shrinking, warping, or discoloring. **Do not install** the range directly over interior kitchen carpeting unless a sheet of ¼ inch plywood or a similar insulator is placed between the range and carpeting.
- Select a location where a grounded, 3-prong outlet is easily accessible.
- If the range is located near a window, **do not hang** long curtains or paper blinds on that window.
- **Do not block or cover** the vents (air openings) located at the rear of the range and at the top and bottom of the door. The vents allow for air circulation that is necessary for the range to operate properly with correct combustion. Blocking or covering the vents may cause incorrect combustion which could result in gas leaks and fire.
- **Make sure** the wall coverings around the range can withstand heat up to 200 °F (93 °C) generated by the range.
- Cabinet storage above the surface of the range should be avoided. If cabinet storage above the range is necessary, allow a minimum clearance of 40 inches (102 cm) between the cooking surface and the bottom of the cabinets or install a range hood that projects horizontally a minimum of 5 inches (12.7 cm) beyond the bottom of the cabinets.
- **Locate** the range out of kitchen traffic paths and drafty locations to prevent poor air circulation.
- If the range is located near a window, NEVER hang long curtains or paper blinds on that window. They could blow over the surface burners and ignite, causing a fire hazard.

Safety information

Cooktop safety

WARNING

To reduce the risk of fire, electric shock, personal injuries, and/or death, observe the following precautions.

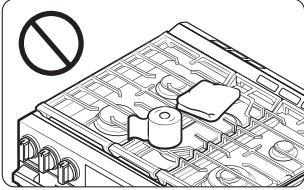

- **Make sure** all burners are off when you are not using the range.
- **Do not use** aluminium foil to line the grates or any part of the cooktop. This can cause carbon monoxide poisoning. Aluminum foil linings may also trap heat, causing a fire hazard. **Do not leave** burners unattended on medium or high heat settings.
- Before igniting the burners, **make sure** all burner caps are properly in place and all burners are level.
 - If you set and use the knob button of safety knob, the original safety function does not work normally.
- **Always use** the Lite position when igniting the burners and make sure the burners have ignited. If ignition fails, turn the knob to Off and wait until the gas has dissipated.
- When you set a burner to simmer, **do not turn** the knob quickly. Make sure the flame stays on.
- **Do not place** any objects other than cookware on the cooktop.
- This cooktop is designed for use with a wok or wok ring attachment.
- To flame food, you must have a ventilation hood. When you flame food, the hood must be on.
- Before removing or changing cookware, turn off the burners.
- Remove food and cookware immediately after cooking.
- Before removing any parts of the burner for cleaning, make sure the range is off and completely cool.
- After cleaning the burner head, make sure it is completely dry before reassembling.
- **Make sure** the spark mark on the dual burner head is placed beside the electrode when it is assembled.
- To avoid carbon monoxide poisoning, do not pour water into the cooktop well while cleaning.
- Select cookware that is designed for range top cooking. Use cookware that is large enough to cover the burner grates. Adjust the burner flames so that the flames do not extend beyond the bottom of the cookware.
- To avoid cookware discoloration, deformity, and/or carbon monoxide poisoning, do not use cookware that is substantially larger than the grate.
- Make sure cookware handles are turned to the side or rear of the cooktop, but not over other surface burners.
- Stand away from the range while frying.
- Always heat frying oils slowly, and watch as they heat. If you are frying foods at high heat, carefully watch during the cooking process. If you are going to use a combination of fats or oils when frying, mix them together before heating.
- Use a deep-fryer thermometer whenever possible. This prevents overheating the fryer beyond the smoking point.
- Use a minimum amount of oil when shallow pan-frying or deep-frying. Avoid cooking unthawed food or food with excessive amounts of ice.
- Before moving cookware full of fats or oils, make sure it has completely cooled.

- To prevent delayed eruptive boiling, always allow heated liquids to stand at least 20 seconds after you have turned off the burner so that the temperature in the liquid can stabilize. In the event of scalding, follow these first aid instructions:
 - Immerse the scalded area in cool or lukewarm water for at least 10 minutes.
 - Do not apply any creams, oils, or lotions.
 - Cover with a clean, dry cloth.

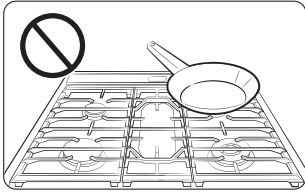

- Place pots in the center of the grate. Do not place a pot larger than 9" in diameter on the rear burners. If you place an oversized pot in the wrong position, it might disrupt necessary air circulation and make the flame on the burner sputter and burn inefficiently.
- **Do not wear** loose or hanging garments when using the range. They could ignite and burn you if they touch a surface burner.
- **Do not leave** plastic items on top of the range. Hot air from the vents on top of the range can melt the plastic and may cause pressure build-up in closed plastic containers. The melted plastic may clog the vents at the rear of the range. Clogged vents may cause incorrect combustion which could result in gas leaks and fire. And you may get severe burns if you touch the surfaces near the vent while the oven is operating.
- **Do not place** portable appliances, or any other object other than cookware on the cooktop. Damage or fire could occur if the cooktop is hot.
- **Always make sure** foods being fried are thawed and dry. Moisture of any kind can cause hot fat to bubble up and over the sides of the pan.
- **Always make sure** the controls are off and the grates are cool before you remove them to prevent any possibility of being burned.
- **Do not put** any combustible material or items around the range.
- **Take care** that your hands do not touch the burners when they are on. Turn off the burners when you change a pan or pot.
- To warm liquid, such as sauces, stir it while warming.
- Opening a window or turning on a ventilation fan or hood is recommended when using the cooktop.

Safety information

Oven safety

WARNING

To reduce the risk of fire, electric shock, personal injuries, and/or death, observe the following precautions.



- **Do not use** the oven for non-cooking purposes such as drying clothes or storage. Use the oven for cooking only.
 - **Make sure** the inner portion of the split oven-rack is in the proper position within the outer rack.
 - **Make sure** the oven racks are placed on the same level on each side.
 - **Do not damage, move, or clean** the door gasket.
- **Do not spray** water on the oven glass while the oven is on or just after you have turned it off.
 - **Do not use** aluminium foil or foil liners anywhere in the oven. Do not use aluminium foil or similar material to cover any holes or passages in the oven bottom or to cover an oven rack. This can cause carbon monoxide poisoning. Aluminum foil linings may also trap heat, causing a fire hazard.
 - Stand away from the oven when opening the oven door.
 - Keep the oven free from grease buildup.
 - When repositioning the oven racks, **make sure** the oven is completely cool.
 - **Only use** cookware that is recommended for use in gas ovens.
 - To avoid damaging the burner control knobs, always bake and/or broil with the oven door closed.
 - **Do not broil** meat too close to the burner flame. Trim excess fat from meat before cooking.
 - When using cooking or roasting bags in the oven, follow the manufacturer's directions.
 - **NEVER cover** any slots, holes, or passages in the oven bottom or cover an entire rack with material, such as aluminum foil. Doing so blocks air flow through the oven and may cause carbon monoxide poisoning. Aluminum foil linings may also trap heat, causing a fire hazard.
 - Opening a window or turning on a ventilation fan or hood is recommended when using the oven.

Storage drawer safety

WARNING

To reduce the risk of fire, electric shock, personal injuries, and/or death, observe the following precautions.



- **Do not use** the drawer for non-cooking purposes such as drying clothes or storage. Use the drawer for cooking purposes only.
- **Do not touch** the interior drawer surface or heating element. These surfaces may be hot and could burn you.
- To avoid steam burns, use caution when opening the drawer.
- **Do not use** aluminium foil to line the drawer.

- **Do not put** the drawer in the oven. Do not put the drawer in the oven during a self-cleaning cycle.
- **Do not leave** containers of fat drippings in or near the drawer.

Self-cleaning oven safety

WARNING

To reduce the risk of fire, electric shock, personal injuries, and/or death, observe the following precautions.

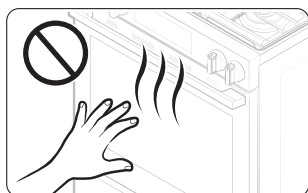

- The self-cleaning feature operates the oven at temperatures high enough to burn away food soils in the oven. The range is extremely hot during a self-cleaning cycle. **Do not touch** any surfaces of the range during a self-cleaning cycle.
- Keep children away from the oven during a self-cleaning cycle.
- Before starting a self-cleaning cycle, **remove** all racks, cookware, and utensils from the oven. Only porcelain-coated oven racks may be left in the oven.
- Before starting a self-cleaning cycle, wipe grease and food soils from the oven.
- **Do not** put the lower drawer into the oven cavity when you run a self-cleaning cycle.
- When opening the door after a self-cleaning cycle, stand away from the oven.
- If the self-cleaning cycle malfunctions, turn off the oven, disconnect the power supply, and contact a qualified service technician.
- Turn off the surface burner while the oven is performing a self-cleaning cycle. Self-Clean will not operate if a surface burner is on.
- Opening a window or turning on a ventilation fan or hood is recommended during and after self-cleaning.

Safety information

1. FCC Notice

FCC STATEMENT:

The manufacturer is not responsible for any radio or TV interference caused by unauthorized modification to this microwave oven. It is the responsibility of the user to correct such interference.

This equipment has been tested and found to comply with the limits for a Class B digital device, pursuant to part 15 of the FCC Rules. These limits are designed to provide reasonable protection against harmful interference in a residential installation. This equipment generates, uses and can radiate radio frequency energy and, if not installed and used in accordance with the instructions, may cause harmful interference to radio communications. However, there is no guarantee that interference will not occur in a particular installation. If this equipment does cause harmful interference to radio or television reception, which can be determined by turning the equipment off and on, the user is encouraged to try to correct the interference by one or more of the following measures:

- Reorient or relocate the receiving antenna.
- Increase the separation between the equipment and receiver.
- Connect the equipment into an outlet on a circuit different from that to which the receiver is connected.
- Consult the dealer or an experienced radio/TV technician for help.

WARNING

Any changes or modifications to this unit not expressly approved by the party responsible for compliance could void the user's authority to operate the equipment.

FCC RF Exposure Requirements

This device complies with FCC RF radiation exposure limits set forth for an uncontrolled environment. The antenna(s) used for this transmitter must not be co-located or operating in conjunction with any other antenna or transmitter and must be installed to provide a separation distance of at least 20 cm from all persons.

2. IC Notice

This device contains licence-exempt transmitter(s)/receiver(s) that comply with Innovation, Science and Economic Development Canada's licence-exempt RSS(s). Operation is subject to the following two conditions:

- 1) This device may not cause interference.
- 2) This device must accept any interference, including interference that may cause undesired operation of the device.
 - CAN ICES(B)/NMB(B)

IC RADIATION EXPOSURE STATEMENT:

This equipment complies with IC RSS-102 radiation exposure limits set forth for an uncontrolled environment. This equipment should be installed and operated so there is at least 8 inches (20 cm) between the radiator and your body. This device and its antenna(s) must not be co-located or operated in conjunction with any other antenna or transmitter.

California Proposition 65 Warning

WARNING

Cancer and Reproductive Harm - www.P65Warnings.ca.gov

Commonwealth of Massachusetts

This product must be installed by a licensed plumber or gas fitter qualified or licensed by the State of Massachusetts. When using ball-type gas shut-off valves, you must use the T-handle type. Multiple flexible gas lines must not be connected in series.

Key features

Bigger is better

With a capacity of 6.0 cubic feet, this Samsung gas oven range offers more space than many other leading brands in the United States and Canadian markets. The enhanced capacity means a better cooking experience.

A cooktop with 5 burners

Power burners, simmer burners, as well as a center oval burner provide flexible cooktop heat for a variety of cookware. The center oval burner delivers heat evenly over a large area, and provides the optimum temperatures for griddle cooking.

Enhanced convenience with easy maintenance

The Samsung gas oven range combines all the benefits of 3 separate home appliances - a gas range, a gas oven, and a storage drawer - to maximize customer convenience with its careful, stylish design.

Overview

Layout

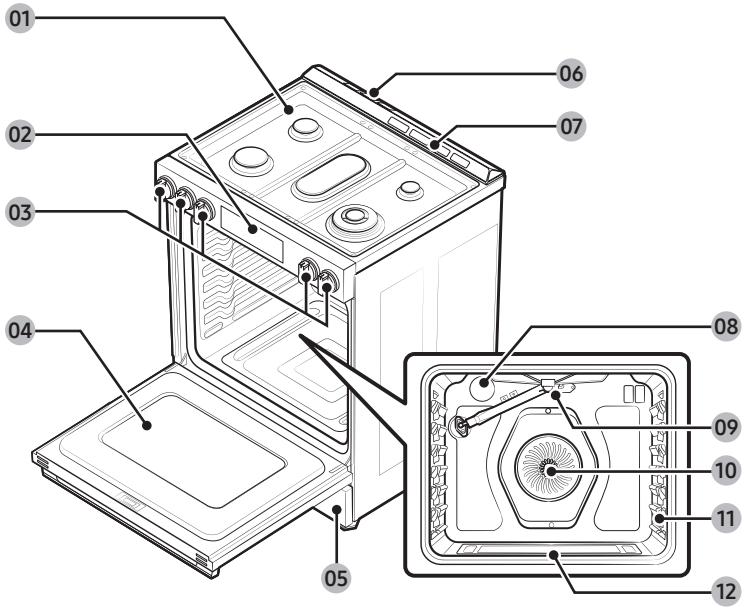

01 Surface burners

03 Surface burner knobs (5 pcs)

05 Storage drawer

07 Oven vents

09 Broil oven burner

11 Oven rack system

02 Control panel

04 Removable oven door

06 Cooling vent

08 Oven light

10 Convection fan / Convection heater

12 Bake oven burner

What's included

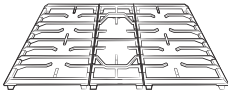

Surface burner grates (3) *



Surface burners and caps (5) *

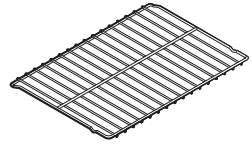

Flat rack (1) *

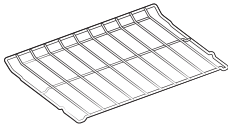

Broil Rack (1) *

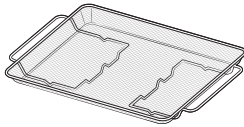

Air Fry Max tray (1) *



Griddle (1) *

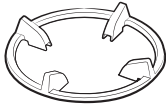

Wok grate (1) *

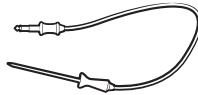

Temp probe (1) *

NOTE

If you need an accessory marked with an asterisk (*), you can buy it from the Samsung Contact Center (1-800-SAMSUNG (726-7864)).

Overview

Control panel

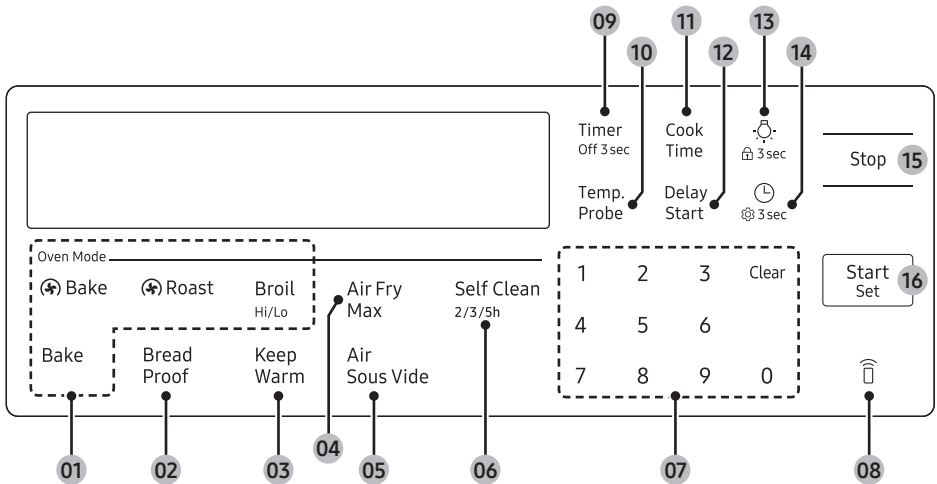

- 01 **Oven modes:** Activates each oven mode (Convection Bake, Convection Roast, Bake or Broil).
- 02 **Bread Proof:** Activates the Bread Proof function.
- 03 **Keep Warm:** Keep Cooked food warm at lower temperature at 175 °F (80 °C).
- 04 **Air Fry Max:** Activates Air Fry Max mode.
- 05 **Air Sous Vide:** Activates the Air Sous Vide function.
- 06 **Self Clean:** Burn off food residues in the oven at very high temperatures.
- 07 **Numbers:** Use to set the times, temperatures, or presets.
- 08 **Smart Control:** Activates the Easy connection.
- 09 **Timer:** Activates or deactivates the timer.
- 10 **Temp. Probe:** Activates the temperature probe (Bake, Convection Bake, or Convection Roast.)
- 11 **Cook Time:** Set the cooking time.
- 12 **Delay Start:** Set the oven to start at a certain time.
- 13 **Oven Light:** Turn on/Turn off the oven light. Press and hold for 3 seconds to use **Lock** feature.
- 14 **Clock:** Set the clock time. Press and hold 3 seconds to use **Setting** feature.
- 15 **Stop:** Cancel the current operation but not the timer.
- 16 **Start/Set:** Start a function or set the time. (Long press to start or set)

Before you start



You should know about the following features and components before you use your range for the first time.

Clock

You must set the clock correctly to ensure the automatic features work properly. This product supports two time formats: 12-hour (default) and 24-hour. To change time format, see page 53.

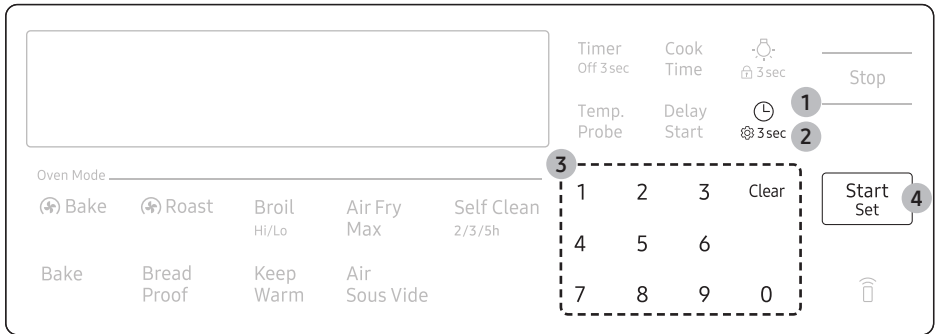
To set the clock time



1. Press .
2. To select AM/PM, press  again. (Skip this step on 24 hour display setting.)
3. Enter the current time using the number pad.
4. Press **Start/Set** to confirm the settings.

NOTE

You can set/change the clock or the kitchen timer before you start a cooking mode or while most cooking modes are operating. However, you cannot set or change the time if a time based function is operating (Time Bake, for example) or the Sabbath option is enabled.

Oven vent/cooling vent

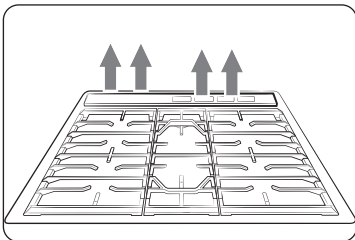

The Oven/Cooling vents are located at the back of the oven range. Proper air circulation prevents combustion problems and ensures good performance.

- Do not block the vent or its surroundings.
- Use caution when placing items near the vent. Hot steam can cause them to overheat or melt.

Cooktop

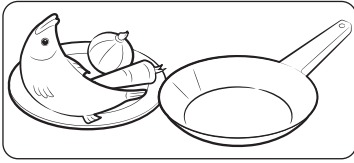

STEP 1

Put all ingredients into a cooking container (pan, pot, etc).

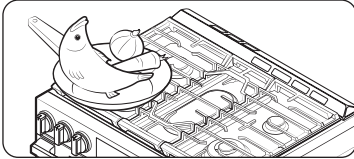

STEP 2

Place the container on a surface burner.

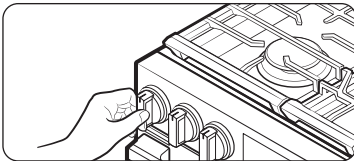

STEP 3

Ignite the surface burner.

Gas burners

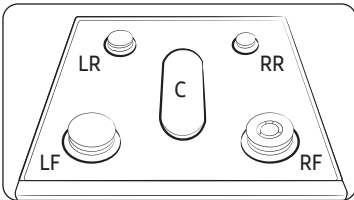

Each burner has a corresponding knob that lets you to set the flame level from Lo to Hi. In addition, each burner knob has a Lite setting. Turning a knob to Lite ignites the corresponding burner. The burner indicators are located above each knob and show which burner the knob controls. Each burner is designed for specific cooking purposes. See the table below.

| Position | Purpose | Food type | Characteristics |
|--------------------------------|----------------------------------|--------------------------------------|---|
| Right Front (RF) 23,000 BTU | Power heating | Boiling food | Maximum output |
| Right Rear (RR) 5,000 BTU | Low simmering | Chocolate, casseroles, sauces | Delicate food that requires low heat for a long time |
| Center (C) 10,000 BTU | General heating/ Griddling | General food/Pancakes, fried eggs | General-purpose cooking |
| Left Front (LF) 16,000 BTU | Quick heating | General | General-purpose cooking |
| Left Rear (LR) 9,500 BTU | General heating/Low simmering | General food, casseroles | General-purpose cooking |

Ignition

CAUTION

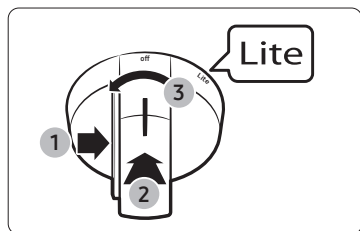

Make sure all surface burners are properly installed. To light a burner:

1. Press the button integrated into the knob.
2. While pressing the button, push in the control knob and then turn it to the Lite position. You will hear a **"Clicking"** sound indicating the electronic ignition system is working properly.
3. After the surface burner lights, turn the control knob to shift it out of the Lite position and turn off the electronic ignition system.
4. Turn the control knob to adjust the flame level.

Manual ignition

If there is a power failure, you can ignite the burner manually. Use caution when doing this.

1. Hold a long gas grill lighter to the surface burner you want to light.
2. Push in the control knob for that burner, and then turn it to the Lite position. Turn on the grill lighter to ignite the burner.
3. After the burner is lit, turn the control knob to adjust the flame level.

Flame level

The flames on the burners should always stay under the cookware, and should not extend beyond the cookware bottom at any time.

CAUTION

- Flames larger than the cookware bottom may result in a fire or physical injury.
- When you set a burner to simmer, do not turn the burner knob quickly. Watch the flame to make sure it stays on.
- After turning on a surface burner, make sure that the burner has ignited. Adjust the level of the flame by turning the burner knob.
- Always turn off the surface burner controls before removing cookware. All surface burner controls should be turned off when you are not cooking.
- Always turn the burners off before you go to sleep or go out.
- If you smell gas, turn off the gas to the range and call a qualified service technician. NEVER use an open flame to locate a leak.
- If you set and use the knob button of safety knob, the original safety function does not work normally.
- To reinstall a removed knob, you must pinch and hold the side buttons while you push the knob all the way onto the shaft until fully seated. Once installed, confirm that the range knob can only be activated with a pinch, push and turn. Failure to do so may result in loss of control or inadvertent activation.

Cooktop

Reinstallation instruction:

CAUTION

Improper installation of knobs can result in deactivation of safety locking.

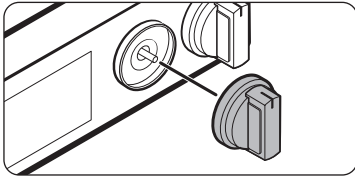

STEP 1

Align and the Knob and shaft.

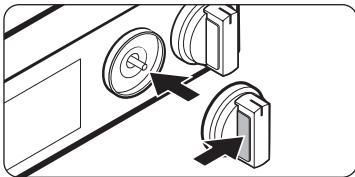

STEP 2

Press and hold the side button.

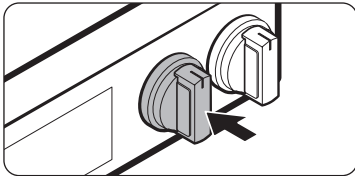

STEP 3

Push the knob fully into the shaft.

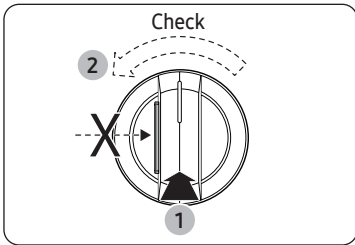

STEP 4

Confirm knob does not rotate without pinch.

Cookware

Requirements

- Flat bottom and straight sides.
- Tight-fitting lid.
- Well-balanced with the handle weighing less than the main portion of the pot or pan.

Material characteristics

- **Aluminum:** An excellent heat conductor. Some types of food may cause the aluminum to darken. However, anodized aluminum cookware resists staining and pitting.
- **Copper:** An excellent heat conductor but discolors easily.
- **Stainless steel:** A slow heat conductor with uneven cooking performance, but is durable, easy to clean, and resists staining.
- **Cast-Iron:** A poor conductor but retains heat very well.
- **Enamelware:** Heating characteristics depend on the base material.
- **Glass:** A slow heat conductor. Use only glass cookware that is specified for range top cooking or oven use.

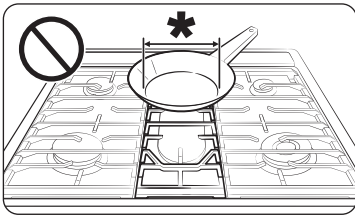

Size limitations

CAUTION

- Do not place a small pan or pot with a bottom diameter of about 6 inches or less on the center grate. This cookware may tip over. Use the rear burners for this small-sized cookware.
- Do not use an oversized pan. The burner flames may spread out, causing damage nearby.

* : 6 inches or less

- Always make sure cookware handles are turned to the side or rear of the cooktop and not over other surface burners. This will minimize the chance of burns, spillovers, and the ignition of flammable materials that can be caused if pots or pans are bumped accidentally.
- When using glass cookware, make sure it is designed for range top cooking.
- **Never leave** plastic items on the cooktop. Hot air from the vent can melt or ignite plastic items or cause build up of dangerous pressure in closed plastic containers. You may get severe burns if you touch the surfaces near the vent while the oven is operating.
- Make sure you hold the handle of a wok or a small one-handled pot while cooking.
- Do not place hot cookware on the control panel, as this may cause discoloration. Be careful not to scratch the surface of the control panel with cookware.

Cooktop

Wok grate

Woks are often used for stir frying, pan frying, deep frying, and poaching. The provided wok grate supports 12" to 14" woks.

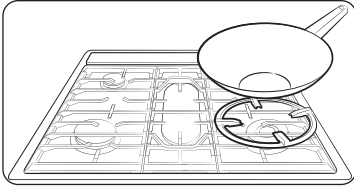

1. Turn off all burners, and wait until the grates completely cool down.
2. Place the wok grate on either side grate.
3. Put a wok on the wok grate. Make sure the wok settles on the wok grate.
4. Turn on the burner, and adjust the flame level as appropriate.

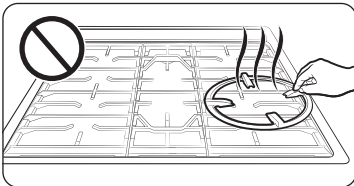

CAUTION

- Do not remove the wok grate until the cooktop grates, surfaces, and wok grate completely cool down.
- When you use the wok with the cooktop or when the oven is on, the wok grate on the cooktop may become very hot. Use oven gloves when placing or removing the wok grate.
- Do not use pans with a flat bottom or woks with a diameter less than the wok ring diameter. The pan or wok may tip over.
- Do not use an oversized pan. The burner flames may spread out, causing damage nearby.
- Do not use the wok grate and the griddle at the same time.
- This cooktop is not designed to flame foods or cook with a wok or wok ring attachment. If foods are flamed, they should only be flamed under a ventilation hood that is on.

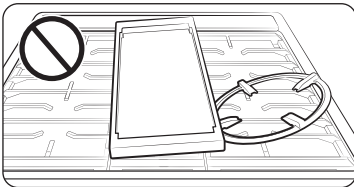

Griddle

The removable coated griddle provides an extra cooking surface. This is useful especially when cooking meat, pancakes, or other foods requiring a large cooking area.

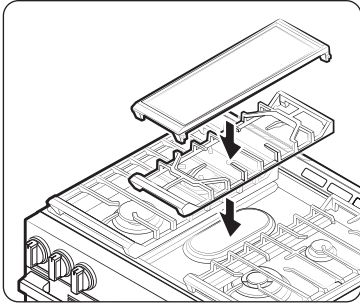

The griddle can be used only with the center burner instead of the center grate. Use caution when putting the griddle on the center burner.

In most cases, you should preheat the griddle before cooking. See the table below.

| Type of Food | Preheating Time | Preheat setting | Cook setting |
|-------------------------|-----------------|-----------------|--------------|
| Pancakes | 5 - 10 min. | Hi | Med - Hi |
| Hamburgers | 5 - 10 min. | Hi | Hi |
| Fried Eggs | 5 - 10 min. | Hi | Med - Hi |
| Bacon | 5 - 10 min. | Hi | Hi |
| Breakfast Sausages | 5 - 10 min. | Hi | Hi |
| Grilled Cheese Sandwich | 4 - 8 min. | Hi | Hi |

CAUTION

- Do not remove the griddle until the cooktop grates, surfaces, and griddle itself cool down.
- If you leave the griddle on the cooktop, it may become very hot when you use the cooktop or oven. Use oven gloves when placing or removing the griddle.
- Do not overheat the griddle. This can damage the coating of the griddle.
- Do not use metal utensils that can damage the griddle surface.
- Do not use the griddle for other purposes, for example, as a cutting board or a storage shelf.
- Do not cook excessively greasy foods. The grease may spill over.
- The griddle is quite heavy because it is made of cast iron. Use both hands when placing or removing the griddle.

NOTE

- You may need to adjust heat settings for the griddle over time.
- The griddle may discolor over time as it becomes seasoned with use.
- Do not let rust remain on the griddle. If rust appears on the griddle, remove it as soon as possible.

Gas oven

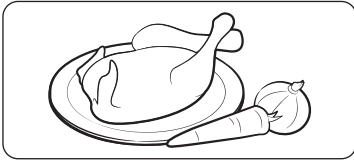

STEP 1

Put all ingredients in a heat-safe container.

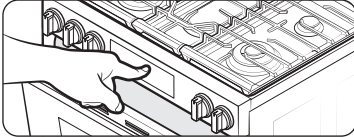

STEP 2

Select a cooking mode, and then start preheating.

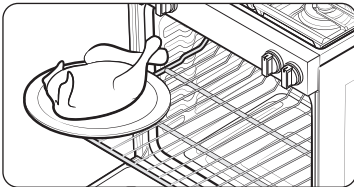

STEP 3

Place the container on a rack.

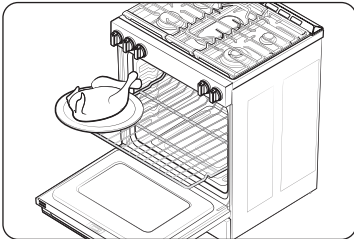

STEP 4

Close the door and start cooking.

NOTE

- The cooling fan automatically runs for a certain amount of time after cooking is complete.
- There can be a slight popping sound during oven cooking. This sound may occur during normal oven burner cycling, when the oven burner flame is extinguished.

Using the oven racks

The rack positions

Your oven range comes with 2 racks and 7 rack positions. The rack positions are delineated by rack guides which support the racks. Each rack guide has a stop that prevents the rack from loosening during the oven's operation. Each rack has stoppers that need to be placed correctly on the rack guides. The stoppers prevent the racks from accidentally coming out of the oven completely when you pull the racks out.

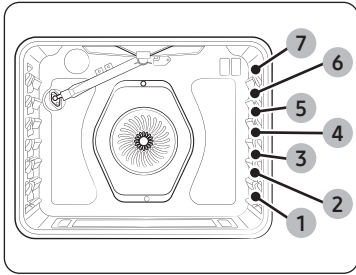

| Type of food | Rack position |
|---|---------------|
| Broiling hamburgers | 6 |
| Broiling meats or small cuts of poultry, fish | 4 - 5 |
| Bundt cakes, Pound cakes, Frozen pies, casseroles | 3 - 4 |
| Fresh Pizza, Angel food cakes, Small roasts | 2 |
| Turkey, Large roasts, Hams | 1 |

CAUTION

- Do not cover an oven rack with aluminum foil. This will hamper heat circulation, resulting in poor baking.
- Do not place aluminum foil on the oven bottom. The aluminum can melt and damage the oven.
- Arrange the oven racks only when the oven is cool.
- When placing an oven rack in the top-most rack position (position 7), make sure the rack is situated stably on the embossed stop.

NOTE

- The Oven Rack Settings table is for reference only.
- We recommend cooking pizza and pies using the 2nd rack position for crispy bottoms.

Inserting and removing an oven rack

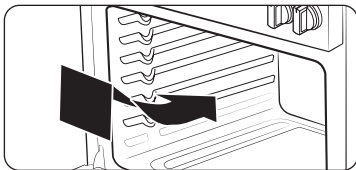

To insert an oven rack

1. Place the rear end of the rack on a rack guide.
2. Slide the rack into the rack guide while holding the front end of the rack.

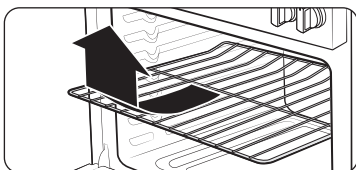

To remove an oven rack

1. Pull out the rack until it stops.
2. Pull up the front end of the rack and remove it from the rack guide.

Gas oven

Rack and Pan placement

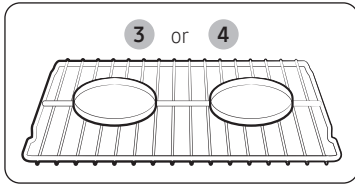

Single Oven Rack

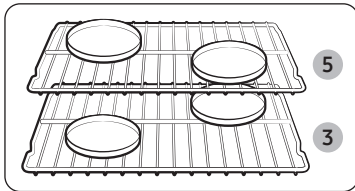

Multiple Oven Rack

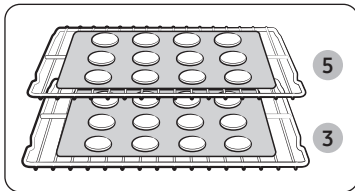

Multiple Oven Rack

Centering the baking pans in the oven as much as possible will produce better results. If baking with more than 1 pan, place the pans so each has at least 1" to 1½" of air space around it.

When baking on a single oven rack, place the oven rack in **position 3 or 4**. See the figure on the left.

When baking cakes and cookies on multiple racks, place the oven racks in **positions 3 and 5**. See the figure on the left.

Using Multiple Oven Racks

| Type of Baking | Rack Positions |
|----------------|----------------|
| Cakes | 3 and 5 |
| Cookies | 3 and 5 |

Before using the racks

The oven has two racks.

Each rack has stops that need to be placed correctly on the supports. These stops will keep the rack from coming completely out.

Removing the racks

1. Pull the rack straight out until it stops.
2. Lift up the front of the rack, and then pull it out.

Replacing the racks

1. Place the end of the rack on the support.
2. Tilt the front end up and push the rack in.

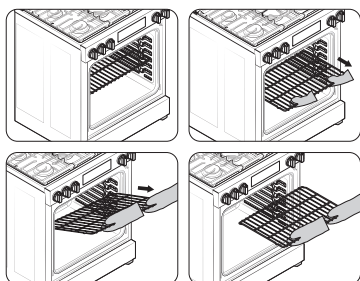

⚠ CAUTION

- Do not cover a rack with aluminum foil or place aluminum foil on the oven bottom. This will hamper heat circulation, resulting in poor baking, and may damage the oven bottom.
- Arrange the oven racks only when the oven is cool.

Cooking mode

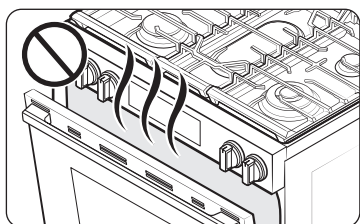

- Make sure to close the door before you start cooking.
- If you leave the door open for 20 - 30 seconds while the oven is in convection baking/roasting, baking, or broiling modes, the oven burner shuts off. To restart the burner, close the door.

Minimum and maximum settings

All the features listed in the table below have minimum and maximum time or temperature settings. A beep will sound each time a pad on the control panel is pressed and the entry is accepted. An error tone will sound in the form of a long beep if the entered temperature or time is below the minimum or above the maximum setting for the feature.

| Mode | Temperature range (°F) | Default temperature (°F) | Temp. Probe | Set Cook Time | Delay Start |
|------------------|------------------------|--------------------------|-------------|---------------|-------------|
| Bake | 175 - 550 | 350 | 0 | 0 | 0 |
| Broil | High - Low | High | X | X | X |
| Convection Bake | 175 - 550 | 325 | 0 | 0 | 0 |
| Convection Roast | 175 - 550 | 325 | 0 | 0 | 0 |
| Air Fry Max | 350 - 500 | 425 | X | 0 | 0 |
| Air Sous Vide | 100 - 205 | 150 | X | 0 | 0 |
| Bread Proof | - | 95 | X | 0 | X |
| Keep Warm | - | 175 | X | X | X |

Gas oven

Baking



Bake is used to cook cakes, cookies, and casseroles. Always preheat the oven first.

Baking temperatures and times will vary depending on the ingredients and the size and shape of the baking pan used. Dark or nonstick coatings may cook faster with more browning.

NOTE

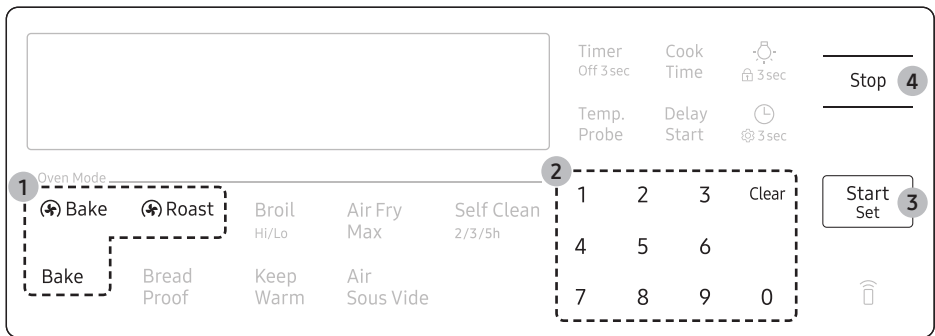
- Place food in the oven after preheating if the recipe calls for it.
- Preheating is very important for good results when baking cakes, cookies, pastry, and breads. After the oven has reached the desired temperature, the oven will beep.
- If you are using an oven thermometer in the oven cavity, the temperature registered by the thermometer may differ from the actual set oven temperature.
- For performance reasons, the convection fan may be turned on or off during the operation.



1. Press  **Bake**,  **Roast**, or **Bake**.
2. If necessary, use the number pad to change the temperature. You can set the oven to any temperature from 175 °F to 550 °F.
3. If necessary, set the Cook Time and Delay Start.
4. Press **Start/Set**.
 - The oven preheats until it reaches the temperature you set.
 - It will beep when it reaches the set temperature.
 - When preheating is complete, place the food in the oven, and then close the door.
5. When cooking is complete, press **Stop**, and then take out the food.

NOTE

- To change the temperature during cooking, repeat steps 1 through 3 above.
- When you have finished cooking, the cooling fan will continue to run until the oven has cooled down.
- For performance reasons, the convection fan may be turned on or off during the operation.

Convection cooking

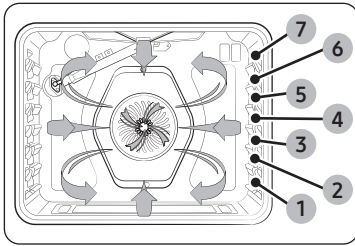

The convection fan at the back of the oven circulates hot air evenly throughout the oven cavity so that food is evenly cooked and browned in less time than with regular heat.

NOTE

- When using convection cooking, always pre-heat the oven for the best results.
- When you have finished cooking, the cooling fan will continue to run until the oven has cooled down.
- For performance reasons, the convection fan may be turned on or off during the operation.

| | |
|----------------------------|--|
| Convection baking | <ul style="list-style-type: none">• Ideal for foods being cooked using multiple racks.• Good for large quantities of food.• Provides the best performance for cookies, biscuits, brownies, cupcakes, cream puffs, sweet rolls, angel food cake, and bread.• Cookies bake best when cooked on flat cookie sheets.• When convection baking using a single rack, place the rack in rack position 3 or 4.• When convection baking using two racks, place the racks in positions 3 and 5 (cakes, cookies).• The oven automatically adjusts the temperature for convection baking. |
| Convection roasting | <ul style="list-style-type: none">• Good for larger, tender cuts of meat, uncovered.• For best performance, place a broiler pan and grid under the meat or poultry. The pan catches grease spills and the grid prevents grease spatters.• Heated air circulates over, under, and around the food. Meat and poultry are browned on all sides as if they were cooked on a rotisserie. |

Gas oven

Broiling

Broiling uses the oven broil burner at the top of the oven to cook and brown food. Meat or fish must be put on a broiling grid in a broiling pan. Preheating for 5 minutes before broiling is recommended.

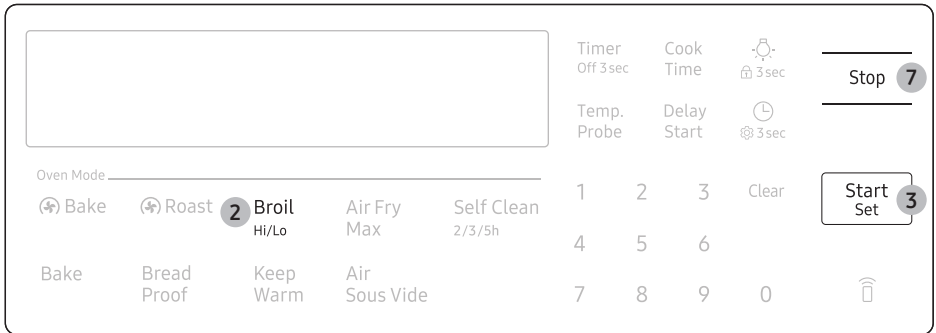

1. Put food on a broiling grid in a broiling pan.
2. Press **Broil** once for Hi temperature broiling or twice for Lo.
3. Press **Start/Set** to start the broiler.
4. Let the oven pre-heat for 5 minutes.
5. Place the pan on the desired rack, and then close the oven door.
6. When one side of the food is browned, turn it over, close the oven door, and start cooking the other side.
7. When cooking is complete, press **Stop**.

NOTE

- Make sure to close the door before you start cooking.
- Use the low temperature setting for poultry or thick cuts of meat to prevent overbroiling.
- In general, to prevent overbroiling, press **Broil** to switch from Hi to Lo.
- Use caution when you open the oven door to turn over the food. The air escaping from the oven will be very hot.
- For information about broiler temperatures, rack settings, and cooking times for different foods, see "**Broiling guide**" on page 35.
- Use the Broil Rack for the best results.

Recipe guide

Broiling guide

 **NOTE**

- This is for reference only.
- Preheating for 5 minutes before broiling is recommended.
- The size, weight, thickness, starting temperature, and your doneness preference will affect broiling times.
- This guide is based on meats at refrigerator temperature.
- If you have covered the meat with aluminum foil and you let it stand covered for 10 minutes after cooking is complete, the internal temperature increases by 5 - 10 °F degrees.
- Use the Broil Rack for the best results.

| Food | Doneness | Size | Thickness | Broil setting | Rack position | Cooking time | |
|----------------|-----------|------------|-----------|---------------|---------------|-----------------|-----------------|
| | | | | | | 1st side | 2nd side |
| Hamburgers | Medium | 9 patties | 1" | Hi | 6 | 4'30" - 5'30" | 3'30" - 4'30" |
| Beef steak | Medium | 1 pc. | 1" | Hi | 5 | 8'00" - 10'00" | 6'00" - 8'00" |
| Chicken pieces | Well done | 2 - 3 lbs. | ¾" - 1" | Lo | 4 | 18'00" - 20'00" | 11'00" - 13'00" |
| Salmon Fillets | Well done | 3 - 4 pcs. | ½" - ¾" | Hi | 5 | 6'00" - 7'00" | 5'00" - 6'00" |
| Pork chops | Well done | 1 - 2 pcs. | ½" - ¾" | Lo | 4 | 12'00" - 14'00" | 12'00" - 15'00" |
| Lamb chops | Medium | 4 - 6 pcs. | 1" | Hi | 5 | 5'00" - 6'00" | 4'00" - 5'00" |

CAUTION

Make sure to close the door after turning over the food.

Gas oven

Air Fry Max mode

This feature represents the next evolution of Air Fry cooking, utilizing advanced heat-distribution algorithms to intelligently adjust temperature and airflow patterns. It delivers crispier and healthier results for frozen or fresh foods, requiring little to no oil compared to traditional convection modes. For optimal performance, use this mode in single oven mode and position the Air Fry Max tray in position 4. The temperature settings range from 350 °F to 500 °F, and preheating is not required.

Enjoy your favorite fried textures up more faster, without compromising flavor or crunch, while achieving perfectly efficient and consistently delicious results every time. Refer to the recipe or package instructions for the appropriate temperature, time, and quantity settings.

How to set the oven for Air Fry Max mode

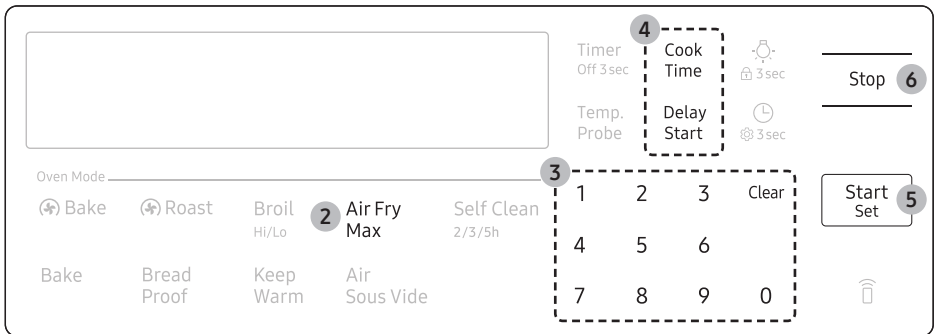

1. Place the tray on rack position 4.
2. Press **Air Fry Max**.
3. Enter the suggested temperature for your food as recommended by its instructions using the number pad.
4. If necessary, set the Cook Time and Delay Start.
5. Press **Start/Set**.
6. When cooking is complete, press **Stop**, and then take out the food.

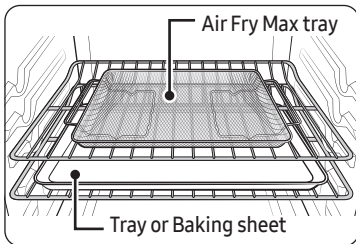

NOTE

- Place a baking sheet or tray on the rack 2 below the Air Fry Max tray for getting any drippings. This will help to reduce splatter and smoke for high fat foods, such as chicken wings.
- Air Fry Max is designed for baking on a single oven rack. Place food on rack position 4 for best results.

Air Fry Max tray recommended placement

- Before using a baking ware, check the maximum allowable temperature of baking sheet.
- Place under a few sheets of paper like parchment paper to absorb the fat for reducing splatter and smoke during the Air Fry Max.

- For cooking fresh or homemade foods, spread the oil over a larger area more evenly, crisping up the food more effectively.
- Wet or thicken coating will not crisp or set to use with the Air Fry Max.

CAUTION

- Foods that are high in fat will smoke when using the Air Fry Max model, such as chicken wings, bacon, sausage and turkey legs.
- Before you start Air Fry Max, turn on an exhaust hood at a high level fan setting.
- Open a window in your kitchen if it is possible to make sure the kitchen is well-ventilated.
- Once the oven has cooled, wipe down the interior of the oven before and after Air Fry Max cooking.
- Regularly, clean the grease filters of exhaust hood for preventing smoke during cooking.
- Avoid opening the oven door, or else it is difficult to maintain the oven temperature, prevent heat loss, and save energy.

Air Fry Max mode guide

NOTE

- Preheating is not necessary.
- Place the Air Fry Max tray on position 4.
- It is recommended to use avocado oil.
- Place a baking sheet or tray on the rack 2 below the Air Fry Max tray to catch any drippings. This will help to reduce splatter and smoke.

| Item | Amount (oz) | Temperature (°F) | Time (min) | Tips |
|-------------------------------|-------------|------------------|------------|---|
| Potatoes | | | | |
| Frozen French Fries | 30 - 35 | 425 - 450 | 25 - 30 | - |
| Frozen French Fries, Seasoned | 25 - 30 | 425 - 450 | 20 - 25 | - |
| Frozen Tater Tots | 40 - 45 | 450 | 20 - 25 | - |
| Frozen Hash Brown | 25 - 30 | 450 | 20 - 25 | - |
| Frozen Potato Wedges | 30 - 35 | 425 - 450 | 20 - 25 | - |
| Homemade French Fries | 25 - 30 | 425 | 25 - 30 | Peel potatoes and cut into sticks with a thickness of 1/3 inch. Soak in cold water for 30 min. Brush with 3tbsp of oil. Add salt and pepper to taste. |
| Homemade Potato Wedges | 25 - 30 | 450 | 30 - 35 | Cut them into wedges. Brush with 3 tbsp of oil. Add salt and pepper to taste. |

Gas oven

| Item | Amount (oz) | Temperature (°F) | Time (min) | Tips |
|--------------------------|-------------|------------------|------------|---|
| Frozen | | | | |
| Frozen Chicken Nuggets | 24 - 28 | 400 - 425 | 18 - 23 | - |
| Frozen Chicken Wings | 30 - 35 | 425 | 25 - 30 | - |
| Frozen Onion Rings | 20 - 25 | 425 | 18 - 22 | - |
| Frozen Fish Fingers | 20 - 25 | 425 | 18 - 22 | - |
| Frozen Chicken Strips | 25 - 30 | 425 - 450 | 20 - 25 | - |
| Frozen Churros | 20 - 25 | 425 | 18 - 22 | - |
| Poultry | | | | |
| Fresh Drumsticks | 35 - 45 | 425 - 450 | 30 - 35 | Brush with 3 tbsp of oil. Add salt and pepper to taste. Air frying foods that are high in fat can create smoke. |
| Fresh Chicken Wings | 30 - 35 | 425 - 450 | 25 - 30 | |
| Chicken Breasts, Breaded | 30 - 35 | 400 - 425 | 35 - 40 | Dip chicken breasts into the flour mixture. Whisk the egg and milk. Dip flour coated breasts into the egg mixture. Place them into breaded crumbs and toss until items are coated with crumbs. Add salt and pepper to taste. Brush with 3 tbsp of oil. |
| Vegetables | | | | |
| Asparagus, Breaded | 15 - 20 | 425 | 25 - 30 | Dip sliced vegetables into the flour mixture. Whisk the egg and milk. Dip flour coated vegetables into the egg mixture. Place them into breaded crumbs and toss until items are coated with crumbs. Add salt and pepper to taste. Brush with 3 tbsp of oil. |
| Egg Plants, Breaded | 20 - 25 | 425 | 25 - 30 | |
| Mushroom, Breaded | 18 - 22 | 425 | 20 - 25 | |
| Onions, Breaded | 18 - 22 | 425 | 25 - 30 | |
| Cauliflowers, Breaded | 30 - 35 | 400 - 425 | 25 - 30 | |
| Vegetable Mix, Breaded | 30 - 35 | 400 - 425 | 25 - 30 | |

Smart Features

Air Sous Vide mode

Air sous vide mode uses low-temperature hot air to implement Sous Vide method without steam or the water tank. In this mode, the oven keeps constant low temperatures, cooking food that can keep its original fragrance and nutrients while offering enriched flavor and soft texture.

How to set the oven for Air Sous Vide mode

1. Place the vacuum sealed bags of food on the rack in position 4.
2. Press **Air Sous Vide**.
3. If necessary, use the number pad to change the default temperature. Enter the suggested temperature for your food as recommended by its instructions. The default temperature is 150 °F.
4. If necessary, set the Cook Time and Delay Start. Air Sous Vide mode can set 99 hrs 59 mins.
5. Press **Start/Set**.
6. When cooking is complete, press **Stop**, and then take out the food.

NOTE

- For cook time setting, see the **Cook Time** section on page 44.
- For delay start setting, see the **Delay Start** section on page 45.



NOTE

- It is not necessary to preheat the oven when using Air Sous Vide mode.
 - Place the vacuum sealed bags of food on the rack 4 of the oven.
 - Use it to cook meat, fish, seafood, poultry or vegetables.
 - Use fresh and quality ingredients only. Trim them in clean conditions and store in the refrigerator.
 - Use heat-resistant vacuum bags for moving and storing ingredients.
 - Never reuse the heat-resistant vacuum bags.
- The cooking time depends on the thickness of food. Addition of salt or sugar may shorten the cooking time.
 - Use Air Sous Vide recommendation guide to find the recommended cooking time and temperature for the food.
 - Only use temperatures below 140 °F (60 °C) to cook foods that can safely be consumed raw.

Tips

- To keep the original taste, we recommend you use less herbs and spices than in ordinary recipes.
- Meat and fish offer better flavors when seared and served.
- Sous vide dishes are best served immediately after cooking.
- If not served immediately after cooked, put the food in ice water and cool down completely. Then, store them under 40 °F (5 °C) to keep the fragrance and texture of food.
- Chicken, especially, is recommended to eat immediately after cooked.

Gas oven

Air Sous Vide recommendation guide

| Food | Doneness | Temperature (°F) | Time (hrs.) |
|----------------------|-----------|------------------|-------------|
| Beef | | | |
| Steak, 1.5" thick | Rare | 130 | 2.5 - 4 |
| | Medium | 140 | 2.5 - 4 |
| | Well done | 155 | 3 - 5 |
| Roast | Medium | 150 | 6 - 12 |
| | Well done | 155 | 6 - 12 |
| Pork | | | |
| Chop, boneless | Tender | 150 | 3 - 5 |
| | Firm | 160 | 3 - 5 |
| Roast | Medium | 150 | 4 - 6 |
| | Well done | 160 | 5 - 7 |
| Pulled pork | Well done | 160 | 15 - 48 |
| Poultry | | | |
| Chicken, breast | Tender | 145 | 3 - 4 |
| | Firm | 160 | 3.5 - 4.5 |
| Duck, breast | Tender | 145 | 3 - 4 |
| Fish | | | |
| Salmon steak | Tender | 130 | 2 - 4 |
| | Well done | 145 | 2 - 4 |
| Cod fillet | Tender | 130 | 2 - 4 |
| Vegetables | | | |
| Asparagus | - | 180 | 0.5 - 2 |
| Potato, sliced | - | 190 | 2 - 4 |
| Sweet potato, sliced | - | 190 | 2 - 4 |
| Carrot, sliced | - | 190 | 2 - 4 |
| Squash, cubes | - | 180 | 2 - 3 |
| Fruit | | | |
| Apple, sliced | - | 180 | 2 - 3 |
| Pineapple, sliced | - | 180 | 1 - 2 |
| Pear, sliced | - | 180 | 2 - 3 |

Temperature probe

The temperature probe lets you cook roasts and poultry to the exact internal temperature you want, taking the guess work out of determining whether a piece of meat is done or not.

You can use the temperature probe with the oven set to **Bake**, **Convection Bake**, or **Convection Roast**. When you use the temperature probe, the internal temperature is shown on the display when it reaches 100 °F.

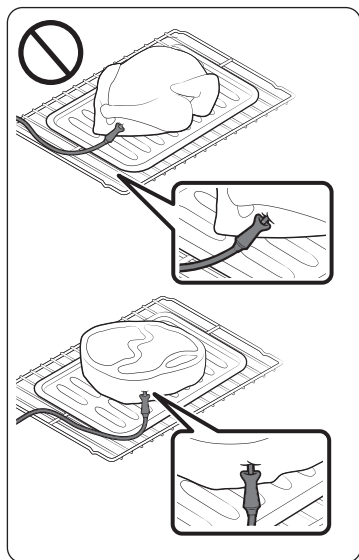

1. Push the temperature probe into the meat so that the tip of the probe reaches the center of the meat.
 - When you insert the temperature probe, make sure it does not contact bone, fat, or gristle.
 - For bone-in meats, insert the probe into the center of the lowest and thickest portion of the piece.
 - For whole poultry (turkey, large chickens, etc.), insert the probe into the thickest part of the inner thigh, parallel to the leg.
 - If you remove the temperature probe while cooking is in process, the oven shuts off in 60 seconds.
 - The temperature probe may not function properly if inserted into frozen food. (The temperature probe icon doesn't appear.)

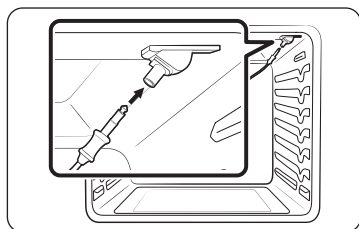

2. Insert the temperature probe plug into the socket on the top side wall of the oven.
3. Select the cooking operation (Convection Bake, Convection Roast, or Bake) and the temperature.

Gas oven

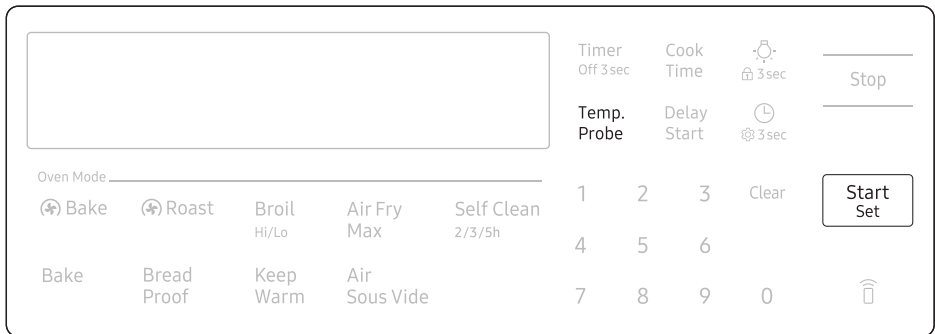

4. Press **Temp. Probe** and use the number pad to set the internal temperature between 100 °F to 200 °F.
5. Set **Delay Start** or **Keep Warm** if necessary.
6. Press **Start**. When the food reaches the set internal temperature, the oven automatically shuts off, and then beeps.

NOTE

Temperature probe operation will shut when the temperature reaches the temperature you set.

Temperature table

| Type of Food | | Internal temperature (°F) |
|--------------|-----------|---------------------------|
| Beef / Lamb | Rare | 140 - 150 |
| | Medium | 160 - 170 |
| | Well done | 170 - 180 |
| Pork | | 170 - 180 |
| Poultry | | 165 - 185 |

CAUTION

- To protect the temperature probe, be careful not to insert the probe so that it comes out of the meat. Make sure that the probe is inserted around the center of the meat.
- Do not store the probe in the oven.
- Do not leave the probe inside the oven during the Self-Cleaning or Broiling cycle. This will cause permanent damage to the probe.
- To avoid damage to the probe, defrost food in advance.
- Do not use tongs when inserting or removing the probe. Tongs can damage the probe.
- Use the temperature probe only for the applicable cooking operations.

NOTE

If you have covered the meat with aluminum foil and you let it stand covered for 10 minutes after cooking is complete, the internal temperature increases by 5 - 10 °F degrees.

Cooking options

CAUTION

Food that can easily spoil, such as milk, eggs, fish, poultry, and meat, should be chilled in a refrigerator before they are placed in the oven. Even when chilled, they should not stand for more than 1 hour before cooking begins and should be removed promptly when cooking is completed.

Timer

The timer gives you an extra timer you can use to time cooking tasks such as boiling eggs. It does not, however, start or stop any cooking operation. You can set the timer from 1 minute to 9 hours and 59 minutes.

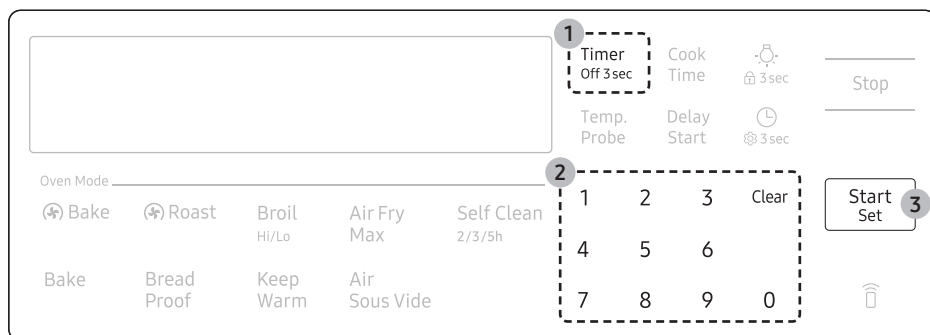

1. Press **Timer Off (3sec)**.
2. Enter a desired time using the number pad.
3. When done, press **Start/Set**.
4. To cancel the Timer settings, press and hold **Timer Off (3sec)** for 3 seconds.
5. When the set time elapses, the oven beeps and displays the "End" message. Press **Timer Off (3sec)** to delete the message.

NOTE

To change the set time, press **Timer Off (3sec)**, enter a different time, and then press **Start/Set**.

Gas oven

Cook Time

Cook Time sets the oven to cook foods at a set temperature for a set length of time. The oven automatically turns off when it finishes.

Mode: Bake / Bake / Roast / Air Fry Max / Air Sous Vide / Bread Proof

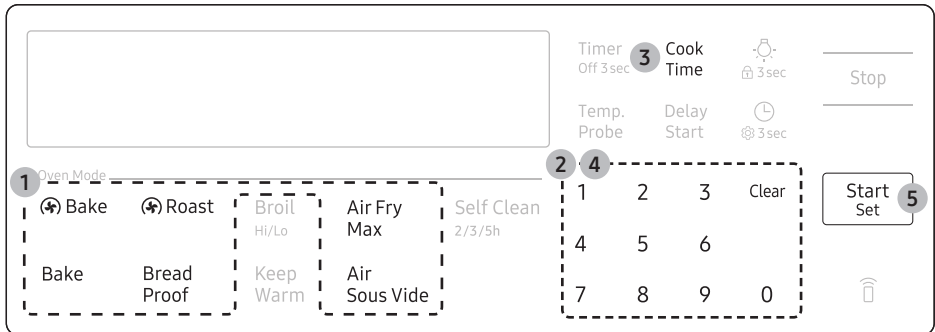

1. Press the pad corresponding to a desired cooking mode such as **Bake**.
2. If necessary, change the temperature using the number pad.
3. Press **Cook Time**.
4. Set the cooking time between 1 minute and 9 hours and 59 minutes (9:59) using the number pad.
5. Press **Start/Set**. The oven will automatically turn on and start preheating. The temperature will increase until it reaches the temperature you set. The oven starts cooking for the amount of time you set.
6. When preheating is complete, put the container with the food on a rack, and then close the door.
7. When the cooking time has elapsed, the oven will automatically shut off and then beep.

NOTE

- To change the programmed cooking time, press **Cook Time**, enter a different time, and then press **Start/Set**.
- If necessary, press **Keep Warm** after setting the cooking time. Then, Keep Warm will start when the cooking time has elapsed.

Delay Start

The Delay Start function lets you use the kitchen timer to automatically start and stop another cooking program. You can set Delay Start so that it delays the automatic start of a cooking operation you select by up to 12 hours.

Mode: Bake / Bake / Roast / Air Fry Max / Air Sous Vide / Self Clean

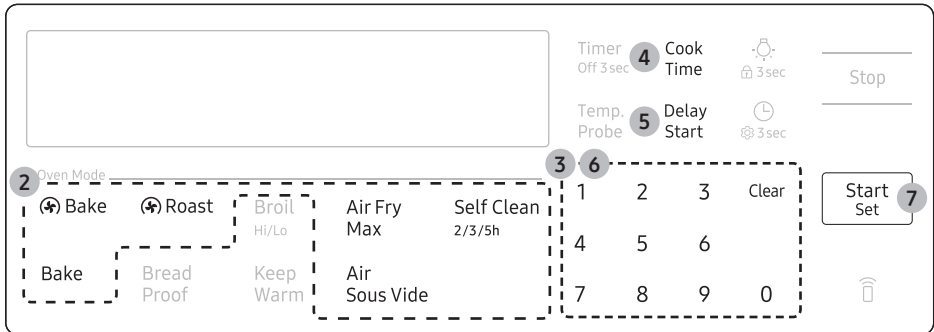

1. Place the container with the food on a rack, and then close the door.
2. Press the pad corresponding to a desired cooking mode such as Bake.
3. If necessary, change the temperature using the number pad.
4. If necessary, press **Cook Time** and set the cooking time (see "Cook Time" on previous page).
5. Press **Delay Start** to change the time elements (AM/PM).
6. Set the starting time using the number pad.
7. Press **Start/Set**.
8. The oven starts cooking at the set time, and turns off automatically when it completes cooking.

NOTE

To change the starting time, press **Delay Start**, and enter a new starting time, and then press **Start/Set**.

Gas oven

Special features

Keep Warm

Keep cooked food warm at a low temperature up to 3 hours.

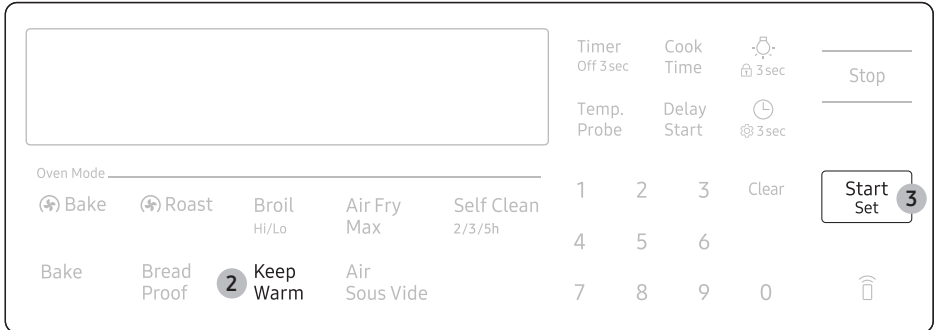

1. Place the container with the food on a rack, and then close the door.
2. Press **Keep Warm**.
3. Press **Start/Set**. The oven heats up to 175 °F (80 °C).

NOTE

- You can cancel warming at any time by pressing **Stop**.
- To set the warming function during a timed cooking, press **Keep Warm** in timed cooking mode. When the timed cooking is complete, the oven will lower the temperature to the warming default, and keep that temperature until the warming finishes or is canceled.

Bread Proof

The Bread Proof function automatically provides the optimum temperature for the bread proof process, and therefore does not have a temperature adjustment.

If you press Bread Proof when the oven temperature is above 100 °F, Hot will appear in the display. Because this function produces the best results when started while the oven is cool, we recommend that you wait until the oven has cooled down and Hot disappears from the display.

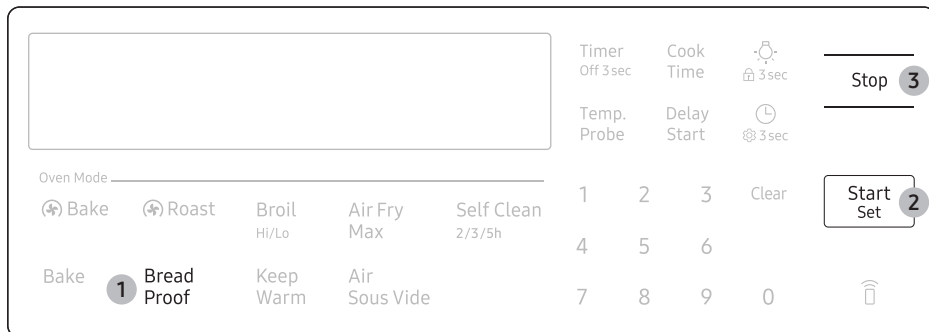

1. Press **Bread Proof**.
2. Press **Start/Set**. (If necessary, press Cook Time and set the cooking time.)
3. Press **Stop** at any time to turn off the Bread Proof function.

NOTE

Use rack position 2 or 3 for bread proofing.

CAUTION

- Do not use Bread Proof when the oven temperature is above 125 °F. If the temperature is above 125 °F, this mode will not heat the oven to the optimal temperature. Wait until the oven cools down.
- Do not use Bread Proof for warming food. The proofing temperature is not hot enough to keep food warm.
- Place the dough in a heat-safe container on rack position 2 or 3 and cover it with a cloth or with plastic wrap. You may need to anchor the plastic wrap underneath the container so that the oven does not blow it off the dough.
- To avoid lowering the temperature and extending proofing time, do not open the oven door.

Gas oven

Pizza (SmartThings App only)

Pizza mode is specifically designed for baking Pizza, delivering a perfectly crispy crust and evenly melted toppings. Utilizing true convection technology, it ensures consistent heat distribution for optimal results.

For the best outcomes, use a pizza stone and place it in the oven during preheating before cooking. The temperature settings range from 350 °F to 500 °F.

This mode can only be started through SmartThings App. Enjoy Pizza dishes easily through App.

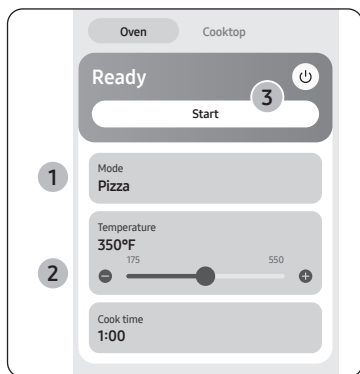

1. Select **Pizza** mode when selecting **Mode** on the Range-Oven Control Screen on SmartThings App.
2. Set Temperature and Cook time on the App.
3. Send **Start** to SET.

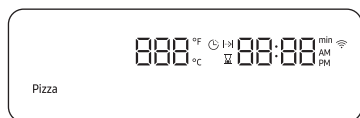

4. The Oven will light up **Pizza** indicator on the display and start cooking in the same way as other normal cooking modes.

The Sabbath Option



(For use on the Jewish Sabbath and Holidays)

Use this option only for baking on the Jewish Sabbath and Holidays. For more information, visit the website at <http://www.star-k.org>

With the Sabbath option

- The oven temperature can be set higher or lower after you have set this option.
- The display doesn't change and the oven will not beep when you change the temperature.
- Once the oven is properly set for baking with the Sabbath option active, the oven will remain continuously on until the Sabbath feature is cancelled. This will override the factory preset 12 hour energy saving feature.
- If the oven light is needed during the Sabbath, press  before activating the Sabbath feature. Once the oven light is turned on and the Sabbath option is active, the oven light will remain on until the Sabbath option is turned off.
- If you want the oven light off, be sure to turn it off before activating the Sabbath feature.
- Do not use the surface cooktop when the Sabbath option is on.

To enable the Sabbath option

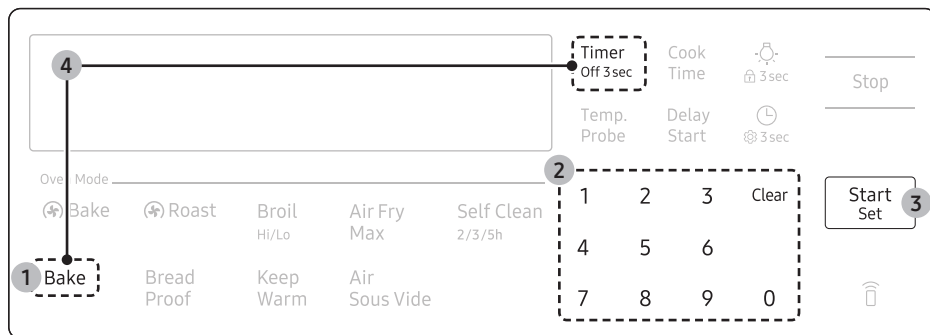

1. Press **Bake**.
2. Enter a desired temperature using the number pad. The default temperature is 350 °F.
3. Press **Start/Set**. The display temperature changes after the oven temperature reaches 175 °F.
4. Press the **Bake** and **Timer** simultaneously for 3 seconds to display "SAb". Once "SAb" appears, the oven control no longer beeps or displays any further changes.

NOTE

- You can change the oven temperature once baking starts, but the display will not change or beep. After changing the temperature, it takes 15 seconds before the oven recognizes the change.
- You can turn off the oven at any time by pressing **Stop**. However, this doesn't deactivate the Sabbath option.
- To deactivate the Sabbath option, hold down **Bake** and the **Timer** simultaneously for 3 seconds.
- You can set the cooking time before activating the Sabbath option.
- After a power failure, the oven will not resume operation automatically. "SAb" will appear in the control panel, but the oven will not turn back on. Food can be safely removed from the oven, but you should not turn off the Sabbath option and turn the oven back on until after the Sabbath/Holidays.
- After the Sabbath observance, turn off the Sabbath option by pressing and holding **Bake** and the **Timer** simultaneously for at least 3 seconds.

CAUTION

- Do not attempt to activate any other functions except for Bake when the Sabbath option is on. Only the following pads will function properly: **Number pads**, **Bake**, **Oven Start/Set**, and **Oven Stop**.
- Do not open the oven door or change the oven temperature for about 30 minutes after you have started the Sabbath option. Let the oven reach the set temperature. The oven fan operates only when the oven temperature increases.

Gas oven

Oven lock

Lock the control panel and the door to prevent accidental operations and/or product tipping. The lock function can prevent children and pets from unintentional oven operation.

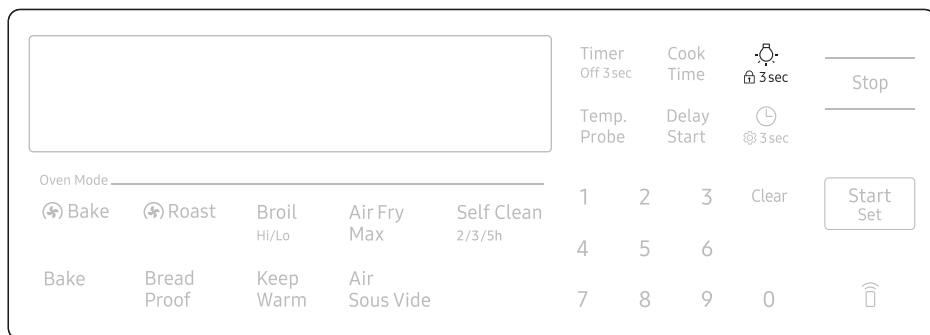

Press and hold  for 3 seconds to lock or unlock both the control panel and the door. When the Oven Lock is on, the oven panel does not operate and the oven door is locked and cannot be opened.

Changing settings

Press and hold  for 3 seconds to change various settings of the range to your preference. The Setting menu is available only when the oven is off.

| Setting | | Description |
|---------|---------------------------|---|
| - | Demo mode | Used by retailers for display purposes only. |
| 1 | Temperature adjust | Recalibrate the oven temperature. |
| 2 | Temp. Unit (°F / °C) | Set the oven control to display temperatures in Fahrenheit or Celsius. |
| 3 | Auto Conversion | Converts regular baking temperatures to convection baking temperatures. |
| 4 | Time format (12hr / 24hr) | Set the clock to display the time in the 12-hour or 24-hour format. |
| 5 | Energy saving | Automatically turns off the oven 12 hours after baking starts or 3 hours after broiling starts. |
| 6 | Sound | Turn the oven's sound (beeps) on or off. |
| 7 | Wi-Fi On/Off | Set the Wi-Fi mode to On/Off. |
| 8 | Welcome Lighting | Shown on cooktop knobs when the oven display wakes up. |

Demo mode

This is used by retailers for display purposes only. In this mode, the heating element does not operate.

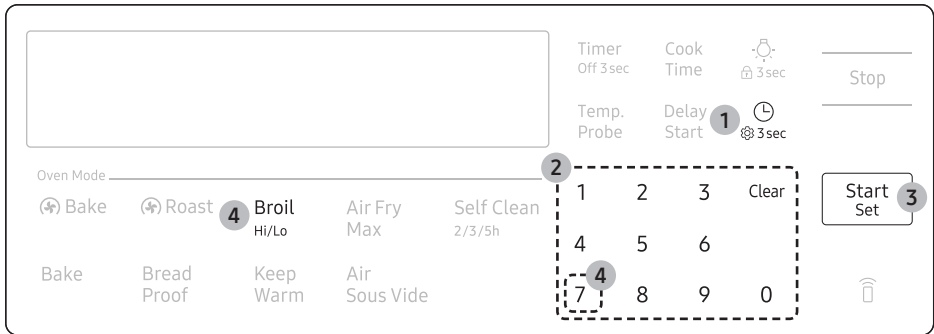

1. Press 3sec.
2. Set the clock time to 12:34.
3. Press **Start/Set** to save change.
4. Press **7** and **Broil** at the same time for 5 seconds.

Temperature adjust

The oven temperature has been calibrated at the factory. When first using the oven, follow the recommended recipe times and temperatures. If it appears that the oven is too hot or too cool, you can recalibrate the oven temperature. Before recalibrating, test a recipe by using a temperature setting that is higher or lower than recommended. The baking results should help you decide how much of an adjustment is needed. The oven temperature can be adjusted by ± 35 °F (± 19 °C).

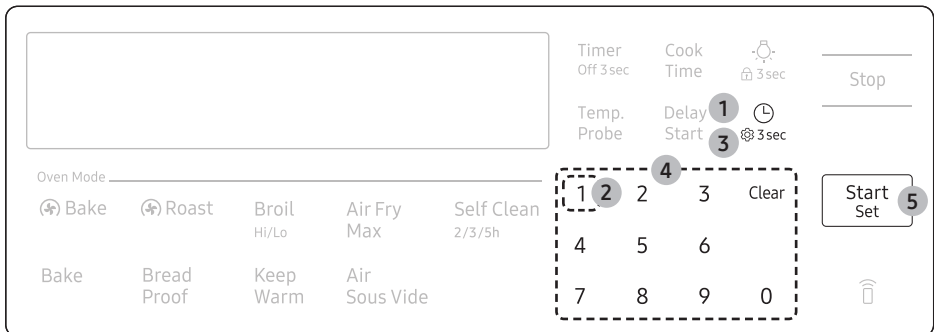

1. Press and hold 3sec for 3 seconds.
2. Press **1** to enter Temperature adjust.
3. Press 3sec pad to select a higher(+) or lower(-) temperature.
4. Enter and adjusting temperature value(0 - 35) using the number pad.
5. Press **Start/Set** to save the change.

Gas oven

NOTE

This adjustment does not affect the broiling or the self-cleaning temperature, and is retained in memory after a power failure.

Temp. Unit (°F / °C)

Change the temperature format of the oven to Fahrenheit or Celsius. The default is Fahrenheit.

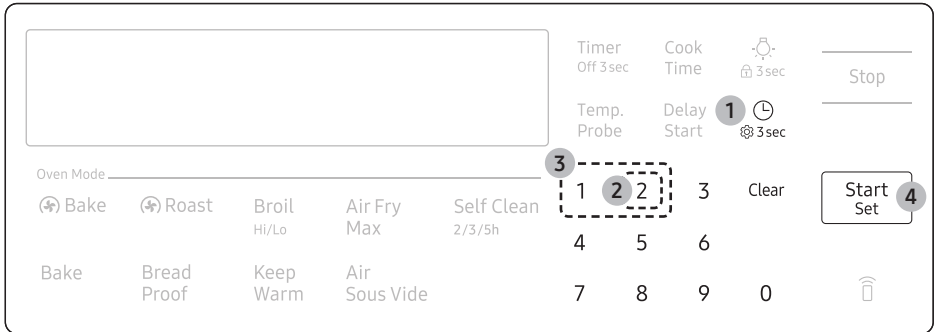

1. Press and hold  for 3 seconds.
2. Press 2 to enter Temperature unit.
3. Press 1 or 2 to change the temperature units. (1 to Fahrenheit, 2 to Celsius.)
4. Press **Start/Set** to save the change.

Auto Conversion

Auto Conversion automatically converts regular baking temperatures to convection baking temperatures. For example, if you enter a regular recipe temperature of 350 °F and press **Start/Set**, the oven displays the converted temperature of 325 °F.

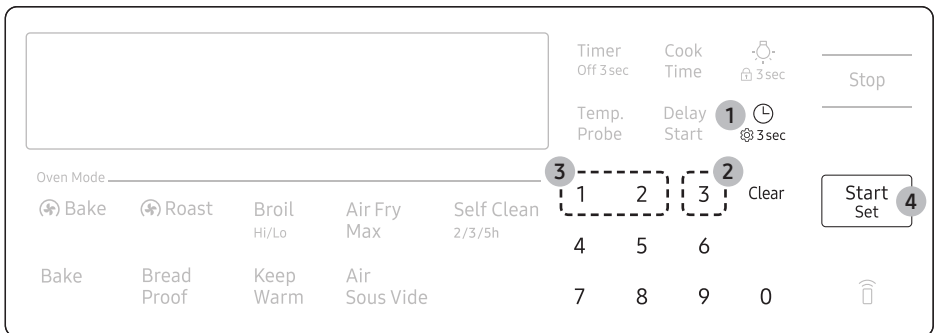

1. Press and hold  for 3 seconds.
2. Press 3 to enter Auto Conversion.
3. Press 1 or 2 to turn Auto Conversion on or off. (1 to on, 2 to off.)
4. Press **Start/Set** to save the change.

Time format

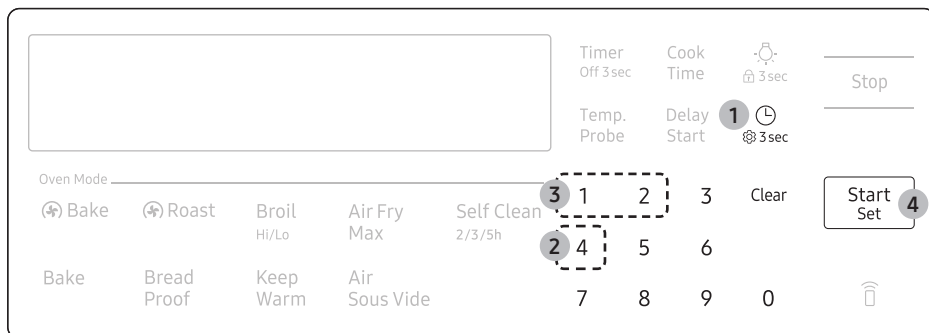

1. Press and hold  for 3 seconds.
2. Press **4** to enter Time format.
3. Press **1** or **2** to change the time format. (1 to 12hr, 2 to 24hr.)
4. Press **Start/Set** to save the change.

Energy saving

This will automatically turn off the oven 12 hours after baking starts or 3 hours after **Broil / Keep Warm** starts.

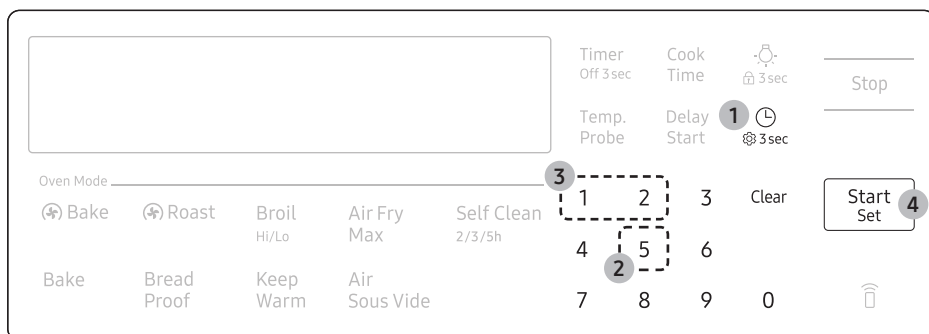



1. Press and hold  for 3 seconds.
2. Press **5** to enter Energy saving.
3. Press **1** or **2** to turn Energy saving on or off. (1 to on(12Hr), 2 to off(--Hr).)
4. Press **Start/Set** to save the change.

Gas oven

Sound

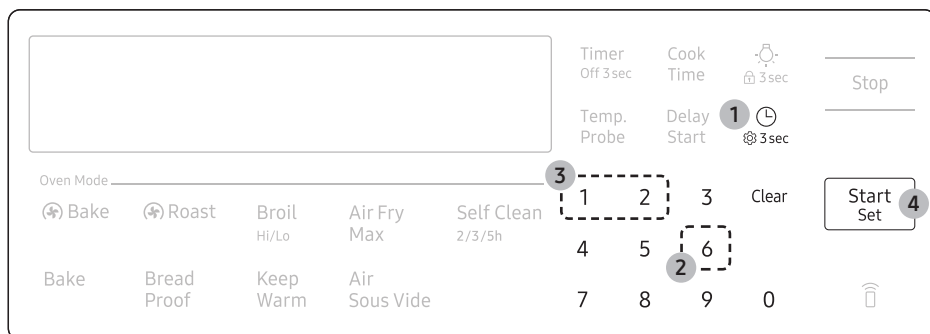
Mute/unmute the range.



1. Press and hold  for 3 seconds.
2. Press **6** to enter Sound.
3. Press **1** or **2** to turn sound on or off. (1 to on, 2 to off.)
4. Press **Start/Set** to save the change.

Wi-Fi On/Off

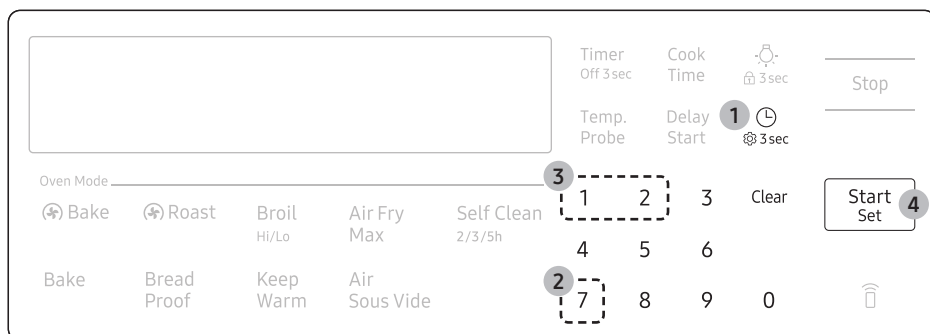

1. Press and hold  for 3 seconds.
2. Press **7** to enter Wi-Fi.
3. Press **1** or **2** to turn Wi-Fi on or off. (1 to on, 2 to off.)
4. Press **Start/Set** to save the change.

Welcome Lighting

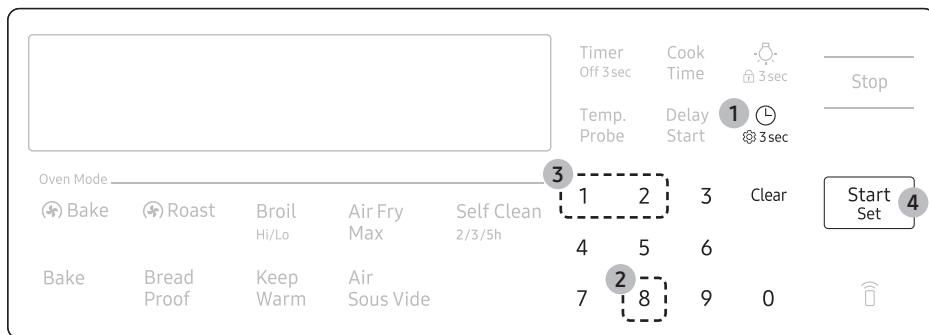

1. Press and hold  for 3 seconds.
2. Press **8** to enter Welcome Lighting.
3. Press **1** or **2** to turn Welcome Lighting on or off. (1 to on, 2 to off)
4. Press **Start/Set** to save the change.

Smart control

Before using smart control feature, set Wi-Fi mode to on (See page 54).

How to connect the oven

1. Download and open the SmartThings app on your smart device.
2. Follow the app's on-screen instructions to connect your range.
3. Once the process is complete, the connected  icon located on your range displays and the app will confirm you are connected.
4. If the connection icon does not turn on, follow the instruction on the app to reconnect.

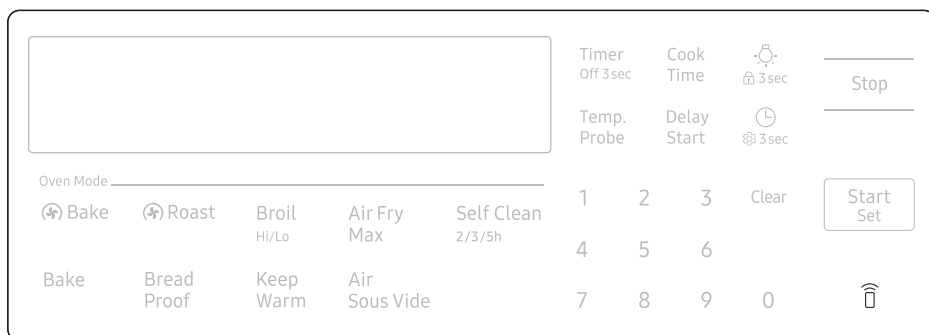



NOTE

You can download a new mode through the SmartThings App.



Gas oven

To control the oven remotely

1. Press **Smart Control**.  appears in the display. The oven can now be controlled remotely with a connected device.
2. Select the oven icon on the SmartThings app to open the Oven Control app. When the app is connected to the oven, you can perform the following functions through the application:

| Oven remote control using the SmartThings app | |
|--|--|
| Oven/ Cooktop Monitoring | <ul style="list-style-type: none">• Check the status of the oven.• Monitor the on/off status of each cooktop burner. |
| Oven Remote Control | <ul style="list-style-type: none">• Set or adjust oven settings remotely. |
| My Cooking | <ul style="list-style-type: none">• Turn the oven off remotely.• Once cooking starts, change the set cooking time and temperature remotely. |
| Error Check | <ul style="list-style-type: none">• Automatically recognize errors. |
| Temp Probe | <ul style="list-style-type: none">• Monitor the current temperature and reset the probe setting. (Available models only.) |
| <ul style="list-style-type: none">• If  is not shown in the display, you are still able to monitor the oven and cooktop status and turn the oven off. | |

NOTE

- Opening the oven door or pressing **Smart Control** will delete  from the display and prevent most of the remote functions from operating.
- When oven cooking is finished or cancelled,  is removed from the display.
- For safety reasons, you cannot turn on the gas oven remotely.
- For safety reasons, you must specify the cooking time to enable remote control.
- The oven continues operating even if the Wi-Fi connection is lost.
- **Smart Control** will not work properly if the Wi-Fi Connection is unstable.
- See the SmartThings app manual for detailed information.

Voice control

To use the Range's Voice Control function, you need Bixby / Amazon Alexa App / Google Assistant App on your mobile device.
Refer to the table below for all available functions.

Bixby

- Bixby is the name of Samsung's artificial intelligence solution that makes it possible to control the product by voice.
- To use the voice recognition function, you need to connect the SmartThings app and the product on your smartphone.
- For models that do not directly recognize voice input for the product after connecting to the app, some functions can still be controlled through Bixby on Samsung smartphones.
- SmartThings App → Voice Assistant → Bixby, you can refer to the Bixby utterance of device.

Amazon Alexa & Google Assistant

Samsung smart home appliances are supported by SmartThings skill in Alexa & action in Google Assistant.

Installation Guide

Here's how to link SmartThings account into Amazon Alexa or Google Assistant. SmartThings App and Alexa App(or Google Assistant App) should be installed on your phone.

1. Setup supported devices on SmartThings
2. After device setup, tap '**Voice assistant**' and link your Samsung account to Amazon Alexa.
3. Check to see if the devices are visible on Amazon Alexa app. If visible, account linking is complete. (Check that the devices are visible and set the location (home & room) of devices in Google home app. Then account linking is complete.)



NOTE

On/Off spec of smart control is same as guided in SmartThings app.

Maintenance



Cleaning

CAUTION

Wear the glove during cleaning.

Control panel

First, lock the control panel and the door to prevent accidental operations and/or product tipping.

1. Press and hold  for 3 seconds to lock both the control panel and the door.
2. Clean the control panel using a soft cloth dampened with plain water, warm soapy water, or glass cleaner. Do not spray cleansers directly onto the control panel.
3. When done, press and hold  again for 3 seconds.

WARNING

- Make sure the control panel turns off and all surfaces of the range are cool before cleaning. Otherwise, you can get burned.
- If the range has been moved away from the wall, make sure the Anti-Tip device is reinstalled properly when the range has been put into place again. Otherwise, the range may tip over, causing physical injuries.
- Do not use steel-wool or abrasive cleansers of any kind. These can scratch or damage the surface.

Stainless steel surface

1. Remove any spills, spots, and grease stains using a soft, wet cloth.
2. Apply an approved stainless steel cleanser to a cloth or paper towel.
3. Clean one small area at a time, rubbing with the grain of the stainless steel if applicable.
4. When done, dry the surface using a soft, dry cloth.
5. Repeat steps 2 through 4 as many times as necessary.

CAUTION

- Do not use a steel-wool pad or abrasive cleanser on stainless steel surfaces. It will scratch the surface.
- Do not spray any type of cleanser into the manifold holes. The ignition system is located in those holes and must be kept free of moisture.

Racks

To keep the racks clean, remove them from the cavity, and soak them in lukewarm soapy water. Then, scour soil off of the racks using a plastic scouring pad. If the racks do not slide in and out smoothly after you have cleaned them, rub the side rail guides with wax paper or a cloth containing a few drops of cooking oil. This will help the racks glide more easily on their tracks.

NOTE

- Do not put the racks in a dishwasher.
- If a rack does not slide in and out smoothly, apply a few drops of cooking oil to the oven rack guides.
- If a rack becomes too difficult to slide in or out, lubricate the rack with graphite lubricant.
- To purchase the graphite lubricant, contact us at 1-800-SAMSUNG (726-7864).
- For online shopping, visit <http://www.samsungparts.com/Default.aspx> and search for part DG81-01629A.

CAUTION

- Do not leave the racks in the oven during the self-cleaning cycle. The extreme heat generated in this cycle can permanently peel off the rack coating and make it difficult to slide the racks on the guide rails.
- Do not spray cooking oil or lubricant directly onto the racks.

Air Fry Max tray

To keep the Air Fry Max tray clean, remove them from the cavity, and soak them in lukewarm soapy water. Then, scour soil off of the Air Fry Max tray using a plastic scouring pad.

NOTE

The air fry max tray is dishwasher-safe.

CAUTION

Do not leave the air fry max tray in the oven during the self-cleaning cycle. The extreme heat generated in this cycle can permanently peel off the air fry max coating, their color will turn slightly blue and finish will be dull.

Oven

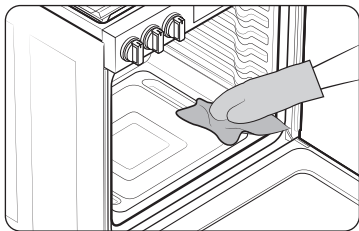

Wear the glove during cleaning.

Door

Do not remove the inner gasket of the oven door for cleaning.

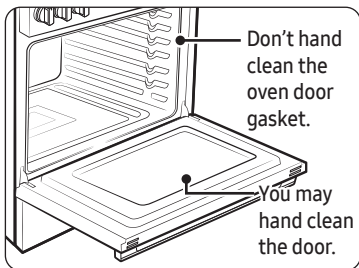

- Use soap and water to thoroughly clean the top, sides, and front of the oven door. Rinse well. You may use a glass cleaner on the outside glass of the oven door. DO NOT immerse the door in water. **DO NOT spray or allow water or the glass cleaner to enter the door vents.** DO NOT use oven cleaners, cleaning powders, or any harsh abrasive cleaning materials on the outside of the oven door.
- **DO NOT clean the oven door gasket.** The oven door gasket is made of a woven material which is essential for a good seal. Care should be taken not to rub, damage, or remove this gasket.

Maintenance

Door inner side

- **Inner surface:** Clean the inner side of the door manually using a soapy plastic scouring pad, and then wipe with a dry cloth. Take care not to get the gasket wet or allow moisture into the door.
- **Inner glass:** The inner glass is cleaned automatically during the self-cleaning cycle.

Door outer side

- **Outer surface:** Follow the cleaning instructions for the stainless steel surface in the previous section.
- **Outer glass:** Clean the outer glass using a glass cleanser or soapy water. Rinse and dry thoroughly. Take care not to get the gasket wet or allow moisture into the door.

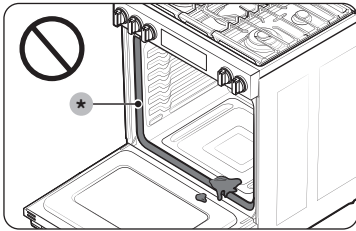

⚠ CAUTION

Do not let moisture enter the door or contact the door gasket. Moisture may reduce the gasket's performance.

Drawer Handle

Remove dust with soft brush or soft cloth covered with water.

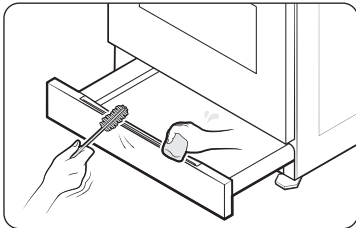

⚠ CAUTION

- Do not use alkaline detergents, sulfuric acid, hydrochloric acid, organic solvents, or disinfectants.
 - Surface can be damaged.

Burner controls

Make sure all surface burner knobs are in the Off position.

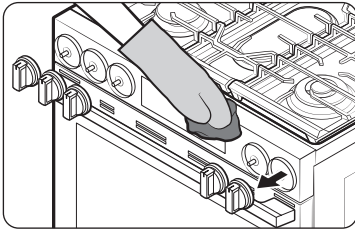

1. Pull knobs off the control valve stems.
2. Clean the knobs in warm, soapy water. Then, rinse and dry them thoroughly.
3. Clean the stainless steel surfaces using stainless steel cleaner.
4. Re-attach the knobs to the control valve stems.

⚠ CAUTION

- Do not clean the control knobs in a dishwasher.
- Do not spray cleansers directly onto the control panel. Moisture entering the electric circuits may cause electric shock or product damage.
- To reinstall a removed knob, you must pinch and hold the side buttons while you push the knob all the way onto the shaft until fully seated. Once installed, confirm that the range knob can only be activated with a pinch, push and turn. Failure to do so may result in loss of control or inadvertent activation.

Cooktop surface

The porcelain-enameled cooktop surface needs to be kept clean. We recommend that you remove food spills immediately after they take place.

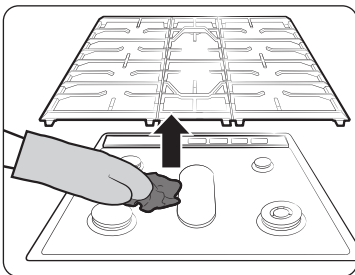

1. Turn off all surface burners.
2. Wait until all burner grates and griddle cool down, and then remove them.
3. Clean the cooktop surface using a soft cloth. If food spills run into gaps of the burner components, remove the burner cap and the head, and wipe up the spills.
4. When cleaning is finished, reinsert the burner components, and then put the burner grates and griddle back into position.

⚠ CAUTION

- Do not use a steel-wool pad or abrasive cleaner, which can scratch or damage the enamel surface.
- Do not remove the cooktop surface to clean it. The gas lines leading to the burner manifolds can be damaged, resulting in a fire or system failure.
- Do not pour water into the cooktop well while cleaning the cooktop. This could leak down into the range gas and electrical systems creating a risk of electrical shock or high levels of carbon monoxide due to corrosion of the gas valves or ports.
- Keep oven vent ducts unobstructed. Clean vents frequently to avoid grease buildup.

Maintenance

Burner grates and components

Turn off all surface burners and make sure they have all cooled down.

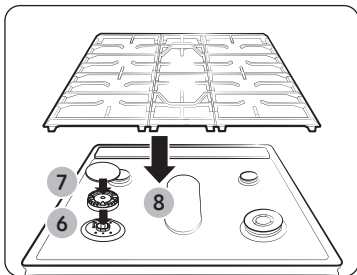
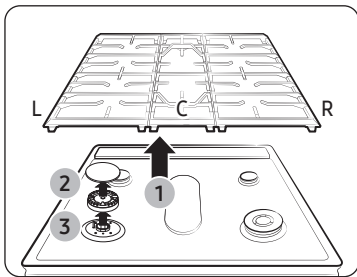

1. Remove the center burner griddle(C) following both sides grates.(L/R)
2. Remove the burner caps from the burner heads.
3. Remove the burner heads from the valve manifolds to reveal the starter electrodes.
4. Clean all removable grates, griddle and burner components in warm, soapy water. Do not use steel-wool pads or abrasive cleaners.
5. Rinse and dry grates, griddle and burner components thoroughly.
6. Return the burner heads to their positions on top of the manifold valves. Make sure a starter electrode is inserted through the hole in each burner head.

NOTE

See the next page for detailed burner component re-assembly instructions.

7. Return the burner caps to their positions on top of the burner heads. To ensure proper and safe operation, make sure the burner caps lie flat on top of the burner heads.
8. Reinstall the burner grates and griddle in their respective positions.
9. Turn on each burner and check if it operates properly. After verifying that a burner operates normally, turn it off.

NOTE

- After cleaning, confirm that the burner port openings aren't plugged.
- Shake out any excess water and then let burner heads and caps dry thoroughly. Placing the center burner upside down will allow the water to drain out more easily.
- Do not wash any burner components in a dishwasher.

CAUTION

- The starter electrodes are not removable. Do not attempt to remove them by force.
- To avoid chipping, do not bang grates and caps against each other or against hard surfaces, such as cast iron cookware.
- The burner head can be blocked by food or dust. Clean the head if it appears blocked. If you clean the head with water, assemble it only after it is completely dry. If the head is wet, it might prevent the burners from igniting.
- To avoid falling down the grates, make sure to remove both sides grates first.
- Do not attempt to remove center oval burner cap from the head.

Burner reinstall guide

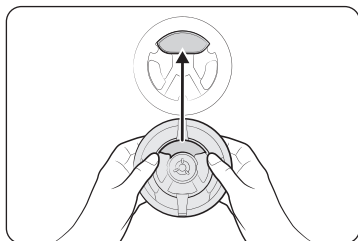

Dual burner head

1. Orient the burner head so that the opening for the electrode lines up with the electrode.
2. Install the burner head so that the electrode passes through the opening for the electrode. Make sure the burner head lies flat on the stove top.

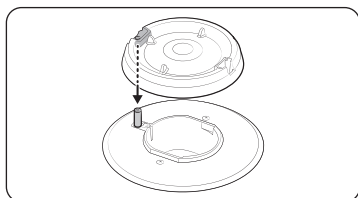
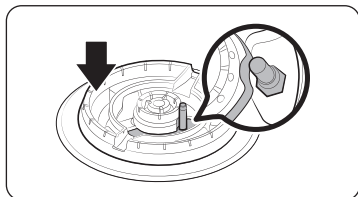

Round burner head

1. Orient the burner head so that the opening for the electrode lines up with the electrode.
2. Install the burner head so that the electrode passes through the opening for the electrode. Make sure the burner head lies flat on the stove top.

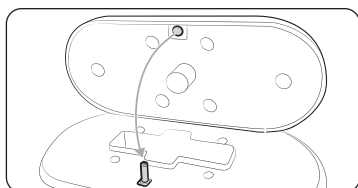
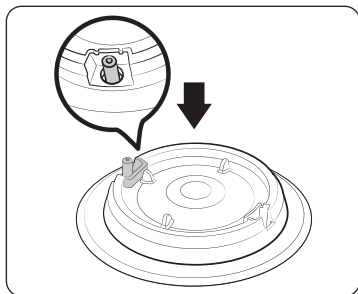

Oval burner

1. Orient the burner head so that the opening for the electrode lines up with the electrode.

Maintenance

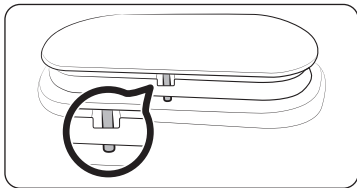

2. Install the burner head so that the electrode passes through the opening for the electrode. Make sure the burner head lies flat on the stove top.

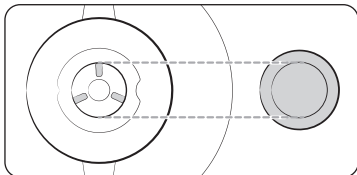

Burner cap

Match the burner caps to the burners by size, and then reinstall the caps on the burner heads.

CAUTION

Make sure each cap is reinstalled on the correct burner head, is centered on the burner head, and lies flat.

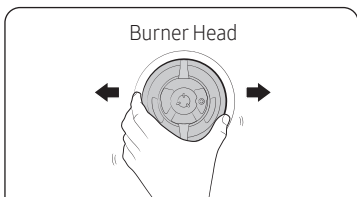
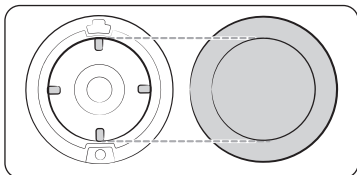
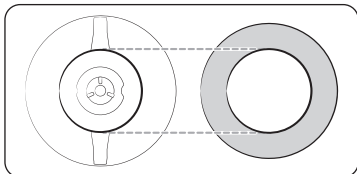

CAUTION

Make sure all burner components (heads and caps) are reinstalled properly. They will be stable and rest flat when correctly installed.

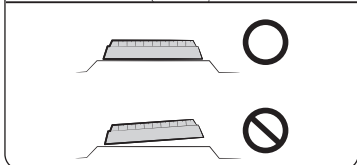

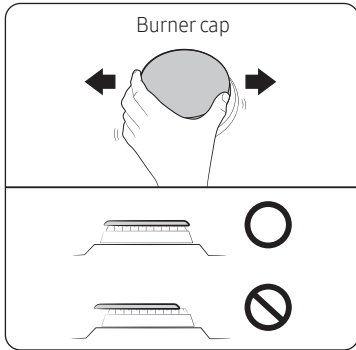

| Top | Bottom |
|-----|--------|
| | |

NOTE

The precise simmer burner (RR) cap and the inner Dual burner (RF) cap are interchangeable.

Self-cleaning

This self-cleaning oven uses high temperatures (well above cooking temperatures) to burn off leftover grease and residue completely or reduce them to a finely powdered ash that you can wipe away with a damp cloth.

CAUTION

- Do not leave small children unattended near the range during the self-cleaning cycle. The outside surfaces of the range can get extremely hot.
- Some birds are extremely sensitive to fumes from a self-cleaning oven. Relocate birds to a well-ventilated room away from the range.
- Do not line the oven, oven racks, or oven bottom with aluminum foil. Doing so will result in poor heat distribution, produce poor baking results, and cause permanent damage to the oven interior. The aluminum foil will melt onto and adhere to the interior oven surfaces.
- Do not force the oven door open during the self-cleaning cycle. This will damage the automatic door-locking system. The door automatically locks when the self-cleaning cycle is started and stays locked until the cycle is cancelled and the oven temperature is below 400 °F.
- Use caution when opening the oven door after the self-cleaning cycle. The gas oven will still be VERY HOT and hot air and steam might escape when the door is open.
- Wipe off any excess spillage before using the self-cleaning operation.
- Do not use oven cleaners. Commercial oven cleaners or oven liners should NEVER be used in or around any part of the oven. Residue from oven cleaners will damage the inside of the oven during a self-cleaning operation.
- Do not turn off the surface burner while the oven is performing a self cleaning cycle. Self-clean will not operate if a surface burner is on.

Maintenance

To perform the self-cleaning cycle

Make sure the door lock is released. Remove all racks from the oven cavity.

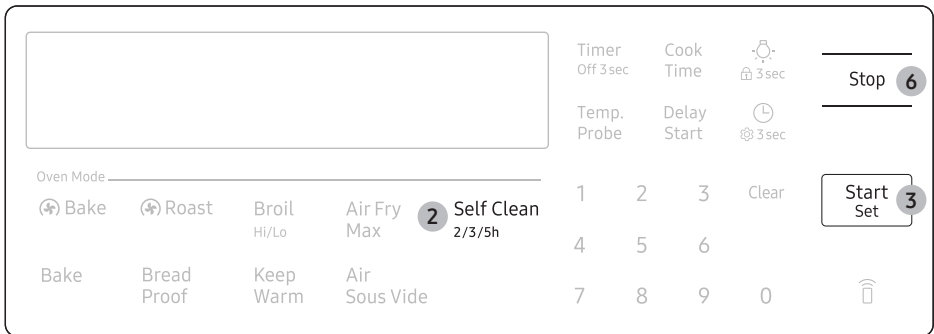

1. Make sure the oven door is closed completely and unlocked.
2. Press **Self Clean** once. Then, select the cleaning time by pressing **Self Clean** one or more times in accordance with the table below.

| Once | Twice | Three times |
|----------------|----------------|----------------|
| 3 - hour cycle | 5 - hour cycle | 2 - hour cycle |

3. Press **Start/Set**. The oven door is locked and the oven begins to heat up.
4. When the self-cleaning cycle is complete, the oven beeps 10 times. The door will remain locked and the Lock icon will blink until the oven temperature falls below 400 °F (204 °C).
5. When the Lock icon changes to an open lock, you can open the oven door. The Lock icon changes to an open lock when the oven temperature drops below 400 °F (204 °C).
6. Press **Stop** to display the time of the day.

CAUTION

Do not use the surface burners while the gas oven is performing a self-cleaning cycle.

WARNING

Be sure all controls are off and all surfaces are COOL before cleaning any part of the range.

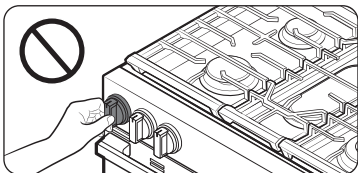

NOTE

Make sure all surface burners are off while the oven is performing a self-cleaning cycle. Self-clean will not operate if a surface burner is on.

To delay starting a self-cleaning cycle

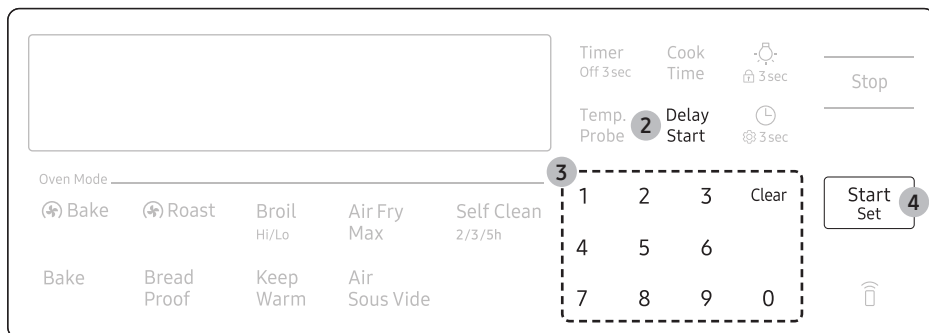

1. Repeat steps 1 and 2 from the previous page.
2. Press **Delay Start**. The oven door locks.
3. Set the time you want the oven to start self-cleaning using the number pad.
4. Press **Start/Set**. The oven will start self-cleaning at your specified time.

To cancel the self-cleaning cycle

You may find it necessary to stop or interrupt a self-cleaning cycle due to smoke in the oven. To turn off the self-cleaning cycle, press **Stop**. The cycle turns off, but the door remains locked and the Lock icon blinks until the oven temperature falls below 400 °F (204 °C).

After self-cleaning

- The door stays locked until the internal oven temperature falls below 400 °F.
- When the oven has cooled down, wipe the oven surfaces with a cloth to remove ash residue.
- Stubborn stains can be removed using a steel-wool pad. Lime deposits can be removed using a vinegar-soaking cloth.
- If you are not satisfied with the cleaning results, repeat the cycle. "HOT" appears on the display until the oven cools down. Wait until the message disappears, and then start a new cycle.
- The cooling fan automatically runs for certain amount of time after self-cleaning.
- Self-cleaning does not operate within 2 hours after running the self-cleaning cycle.

CAUTION

Do not attempt to open the oven door immediately after the self-cleaning cycle is complete. The oven is still very hot when the door unlocks. Escaping hot air and/or steam could burn you.

Maintenance

Replacing the oven light

Oven light

The oven light is a standard 40-watt appliance bulb. It comes on when you open the oven door.

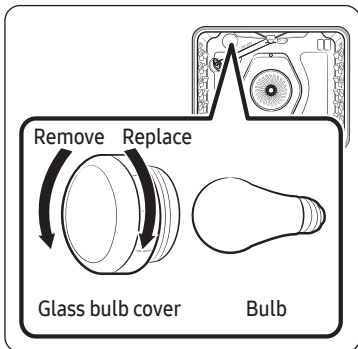

1. Turn off the oven.
2. Make sure the oven and oven light are cool.
3. Open the door, and remove the glass cover by turning it counterclockwise.
4. Remove the oven light from the socket by turning it counterclockwise.
5. Insert a new 40-watt appliance bulb into the socket, and then turn it clockwise to tighten.
6. Reinsert the glass cover, and then turn it clockwise to tighten.

CAUTION

- To prevent electric shock, make sure the oven is turned off and cool before replacing the oven light.
- When replacing the oven light, be careful not to damage the product due to excessive force.

NOTE

- The oven light does not operate during the self-cleaning cycle.
- Remove the racks if they prevent you from accessing the oven light.

Removing and reinstalling the oven door

How to remove the door

CAUTION

- The door is very heavy. Be careful when removing and lifting the door. Do not lift the door by the handle.
 - Turn the power off before removing the door.
1. Open the door completely.
 2. Pull the hinge locks down toward the door frame to the unlocked position.

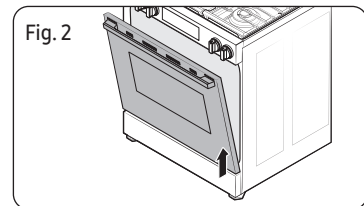
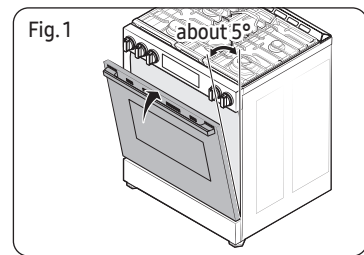
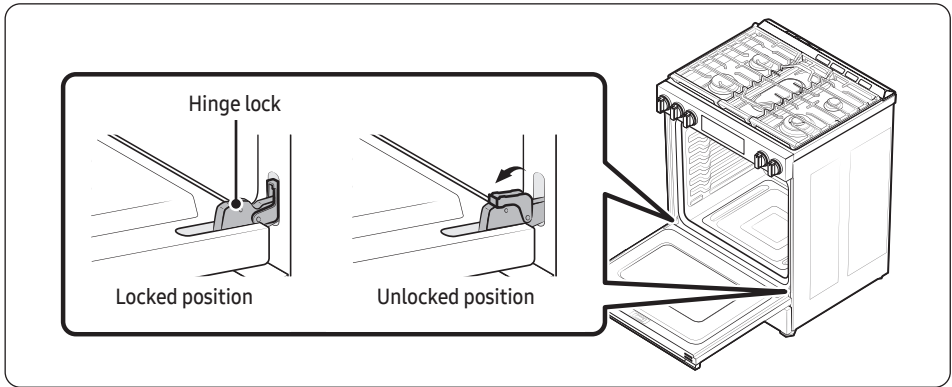

3. Firmly grasp both sides of the door at the top.
4. Close the door to the door removal position, which is approximately 5 degrees from vertical (Fig. 1).
5. Lift the door up and out until the hinge arms are clear of the slots (Fig. 2).

Maintenance

How to reinstall the door

1. Firmly grasp both sides of the door at the top.
2. With the door at the same angle as the removal position, slide the indentations of the hinge arms into the bottom edges of the hinge slots. The notches in each hinge arm must be fully inserted into the bottoms of each slot.

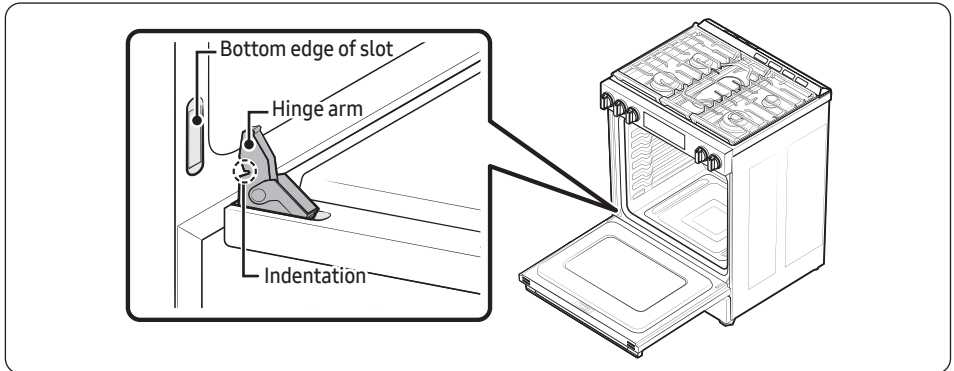

3. Open the door fully. If the door will not open fully, the indentations are not inserted correctly in the bottom edges of each slot.
4. Push the hinge locks up against the front frame of the oven cavity into the locked position.

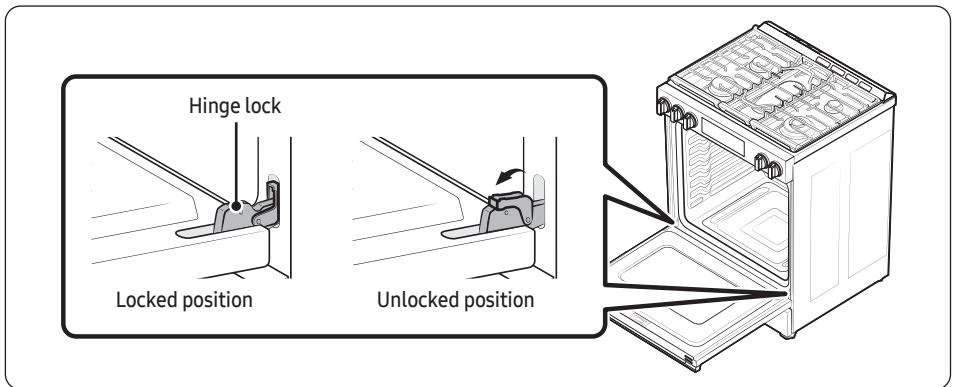

5. Close the oven door.

How to remove and reinstall the Storage drawer

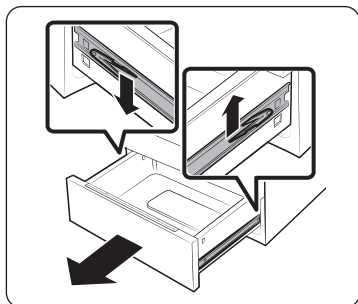

1. Slide open the drawer until it stops.
2. Locate the roller guide clips on either side. Using both hands, pull down the left clip while lifting the right clip, and then remove the drawer.
3. Clean the drawer in warm, soapy water using a cloth or soft brush. Then, rinse and dry it thoroughly.

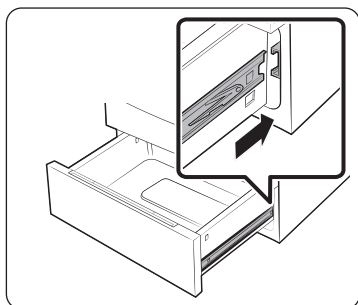

4. Put the drawer in the roller guides on either side, and then snap the clips into place.

Maintenance

NOTE

Please be advised that the Samsung warranty does NOT cover service calls to explain product operation, correct improper installation, or perform normal cleaning or maintenance.

Troubleshooting

If you encounter a problem with the range, check the tables starting below, and then try the suggested actions.

Gas safety

| Problem | Possible cause | Action |
|----------------|--|---|
| You smell gas. | The surface burner knob is not in the Off position and the burner is not lit. | Turn the burner knob to Off . |
| | There is a gas leak. | Clear the room, building, or area of all occupants. Immediately call your gas supplier from a neighbor's phone. Do not call from your phone. It is electrical and could cause a spark that could ignite the gas. Follow the gas supplier's instructions. If you cannot reach your gas supplier, call the fire department. |

Surface burner



| Problem | Cause | Action |
|-------------------------------|---|---|
| All burners do not light. | The power cord is not plugged into the electrical outlet. | Make sure the electrical plug is plugged into a live, properly grounded outlet. |
| | A fuse in your home may be blown or the circuit breaker may have tripped. | Replace the fuse or reset the circuit breaker. |
| | The gas supply is not properly connected or turned on. | See the Installation Instructions that came with your range. |
| Surface burners do not light. | The control knob is not set properly. | Push in the control knob and turn it to the Lite position. |
| | The burner caps are not in place. The burner base is misaligned. | Clean the electrodes. Put the burner cap on the burner head. Align the burner base. |

| Problem | Cause | Action |
|--|---|---|
| Surface burner clicks during operation. | The control knob has been left in the Lite position. | After the burner lights, turn the control knob to a desired setting. If the burner still clicks, contact a service technician. |
| The burners do not burn evenly. | Surface burner components and caps are not assembled correctly and level. | See page 61. |
| | The surface burners are dirty. | Clean the surface burner components. (See page 61.) |
| Very large or yellow surface burner flames. | The wrong burner orifice is installed. | Check the burner orifice size. Contact your installer if you have the wrong orifice (LP gas instead of natural gas or natural gas instead of LP gas). |
| Surface burners light but oven burners do not light. | The oven door lock is turned on. | The display will show the Lock icon. Hold the oven door open and press  for 3 seconds. The oven will beep and the Lock icon will turn off. |
| | The Gas Pressure Regulator shut off switch is in the off position. | Call a qualified service technician. |

Oven

| Problem | Cause | Action |
|--|---|---|
| The oven control beeps and displays an information code. | There may be an issue with your oven. See the "Information codes" chart on page 78. | Press Stop , and then restart the oven. If the problem persists, disconnect all power to the range for at least 30 seconds and then reconnect the power. If this does not solve the problem, call for service. |
| The oven will not turn on. | The oven is not completely plugged into the electrical outlet. | Make sure the electrical plug is fully inserted into a live, properly grounded outlet. |
| | A fuse in your home may be blown or the circuit breaker may have tripped. | Replace the fuse or reset the circuit breaker. |
| The oven temperature is too hot or cold. | The oven temperature needs to be adjusted and recalibrated. | See page 51. |

Maintenance

| Problem | Cause | Action |
|---|---|---|
| The oven burner will not shut off. | The oven door lock is turned on. | The display will show the Lock icon. Hold the oven door open and press  for 3 seconds. The oven will beep and the Lock icon will turn off. |
| | The Sabbath function has been activated. | SAb and the time of day will show in the display. All other controls and signals will be deactivated. To turn off the oven only, press Stop . To cancel the Sabbath function and reactivate the controls and signals, press and hold Bake and Timer simultaneously for 3 seconds. |
| Oven fan is making a noise, or won't turn off. * Slide-In oven model only. | The cooling fan is not visible, but you will hear it running whenever the electronics get hot and turn off when the electronics are cool. | This is normal operation to cool the oven, cooling fan automatically shuts down when the oven cools. |
| The oven light (lamp) will not turn on. | The oven door lock is turned on. | The display will show the Lock icon. Hold the oven door open, and then press  for 3 seconds. The oven will beep and the Lock icon will turn off. |
| | The Sabbath function has been activated. | SAb and the time of day will show in the display. All other controls and signals will be deactivated. To cancel the Sabbath function and reactivate the light switch and other controls, press and hold Bake and Timer simultaneously for 3 seconds. |
| | A loose or burned-out bulb. | See page 68 . |
| | The switch operating the oven light needs to be replaced. | Call for a qualified service technician. |
| The oven smokes excessively during broiling. | Meat or food was not properly prepared before broiling. | Cut away excess fat and/or fatty edges that may curl. |
| | Improperly positioned top oven rack. | See the broiling guide on page 35 . |
| | The controls are not being set properly. | See page 34 . |
| | Greasy buildup on oven surfaces. | Regular cleaning is necessary when broiling frequently. |



| Problem | Cause | Action |
|--|--|--|
| Cooking is finished, but the cooling fan is still running. | The fan automatically runs for a certain amount of time to ventilate the inside of the oven. | This is not a product malfunction. The fan is designed to run automatically for a period of time to cool down the oven. |
| The oven will not self-clean. | The oven door lock is turned on. | The display will show the Lock icon. Hold the oven door open, and then press  for 3 seconds. The oven will beep and the Lock icon will turn off. |
| | The oven is too hot. | Let the oven cool down, and then reset the controls. The self-clean cycle will not lock the oven door if the oven temperature is too hot. The door must lock before the self-clean cycle can start. |
| | The self-cleaning oven controls are not properly set. | Reset the self-cleaning oven controls. (See page 65.) |
| | A surface burner is on. | Turn off the surface burner. Self-clean will not operate if a surface burner is on. |
| A crackling or popping sound. | This is normal. | This is the sound of the metal heating and cooling during any cooking or cleaning function. |
| Excessive smoking during a self-cleaning cycle. | This is the first time the oven has been cleaned. | This is normal. The oven will always smoke more the first time it is cleaned. Wipe up all excessive soil before starting the self-cleaning cycle. If smoke persists, press Stop . Open the windows to clear the smoke from the room. After the oven has cooled and unlocked, wipe up excessive soil, and then reset the oven for self-cleaning. |
| The oven door will not open after a self-cleaning cycle. | This is normal. | The oven door will stay locked until the oven temperature drops below 400 °F. |

Maintenance

| Problem | Cause | Action |
|--|---|---|
| The oven is not clean after a self-cleaning cycle. | A fine dust or ash is normal. | This can be wiped clean with a damp cloth. Set the self-cleaning cycle for a longer cleaning time. The cycle was not long enough to burn off the dirt buildup. Extremely dirty ovens require hand-cleaning of excessive spillovers and food buildup before you start a self-cleaning cycle. Multiple self-cleaning cycles may be necessary to completely clean the oven. |
| There is steam or smoke coming from under the control panel. | This is normal. | The oven vent is located there. More steam is visible when you are using the convection functions or when baking or roasting multiple items at the same time. |
| A burning or oily odor coming from the vent. | This is normal for a new oven and will disappear within 1/2 hour of the first bake cycle. | To speed the process, set a self-cleaning cycle for a minimum of 3 hours. (See page 65.) |
| Strong odor. | This is temporary. | The insulation around the inside of the oven emits an odor the first few times the oven is used. |
| The oven racks are difficult to slide. | This is normal. | Apply a small amount of vegetable oil to a paper towel, and then wipe the edges of the oven racks with the paper towel. Racks become dull and hard to slide if they are left in the oven during a self-clean cycle. |
| Fan noise. | This is normal. | The convection fan runs until the function is over or the door is opened. |
| The convection fan is not working. | This is normal. | The fan starts automatically when the oven reaches the preheat temperature. |



Others

| Problem | Cause | Action |
|---|--|---|
| The product is not level. | The appliance has been installed improperly. The leveling leg(s) is (are) damaged or uneven. | Make sure the floor is level, strong, and stable. If the floor sags or slopes, contact a carpenter. Check and level the range. (See the Installation Instructions.) |
| | The kitchen cabinets are not properly aligned and make the range appear to be not level. | Ensure that cabinets are square and provide sufficient room for installation. |
| The display goes blank. | The electrical outlet Ground Fault Interrupter (GFI or GFCI) has been tripped and needs to be reset. Your digital control has been damaged. | Replace the fuse or reset the circuit breaker. |
| Food does not bake or roast properly in the oven. | The wrong cooking mode was selected. | See page 31. |
| | The oven racks have not been positioned properly for the foods being cooked. | See page 29. |
| | Incorrect cookware or cookware of improper size is being used. | See page 25. |
| | The oven temperature needs to be adjusted and recalibrated. | See page 51. |
| | There is aluminum foil on racks and/or oven bottom. | Remove foil. |
| | The clock or timers are not set correctly. | See pages 21 and 43. |
| Food does not broil properly in the oven. | The oven controls are not set properly. | See page 34. |
| | The oven door was not closed during broiling. | See page 31. |
| | The rack has not been properly positioned. | See the broiling guide on page 35. |

Maintenance

Information codes

| Code symbol | Meaning | Solution |
|--|--|---|
| E-A2 | Check the cooling system. | <ol style="list-style-type: none"> 1. Press Stop, and the restart the oven. 2. If the problem persists, disconnect all power to the oven range for at least 30 seconds and then reconnect the power. 3. If this does not solve the problem, call for service. |
| E-d0 | Control pad malfunction. | |
| E-d1 | Door lock malfunction. | |
| E-F2 | Touch IC and PCB signal malfunction. | |
| E-F6 | Communication between the Main and Sub PCB is interrupted. | |
| E-20 | Oven sensor malfunction. | |
| E-21 | The oven is overheating. | |
| E-22 | Check the Control PBA NTC sensor. | |
| E-23 | Temp probe malfunction. | |
| E-30 | Check the PBA, NTC Sensor. | |
| E-31 | Check the PBA, NTC Sensor. | Call for service. |
| E-24 | Oven vent blocked. | <ol style="list-style-type: none"> 1. If oven vent or cover air is blocked by aluminum foil or others, remove that and restart oven. 2. To reset error, disconnect power or tap Stop after opening the oven door at least 60 seconds. |
| E-25 | Oven temperature did not increase normally. | <ol style="list-style-type: none"> 1. Check if there is a proper gas supply to the oven. 2. Check if the oven liner is being used, then remove it. If the cavity floor hole is blocked, there will be no temperature increase. |
| E-d6 | Gas leakage in the gas connection section. | <ol style="list-style-type: none"> 1. Disconnect power. Open the back cover. Check there are signs of combustion in the gas connection section. 2. If there are signs of combustion, replace GPR and TCO and check the gas leakage. 3. If there are no signs of combustion, check wire-TCO, Wire main - sub connection status and PBA S/W version. |
| <p>** If these solutions do not solve the problem, contact a local Samsung service center or call 1-800-SAMSUNG (1-800-726-7864).</p> | | |

Warranty (U.S.A)

PLEASE DO NOT DISCARD. THE PAGE REPLACES THE WARRANTY PAGE IN THE USE & CARE GUIDE

Samsung GAS RANGE / COOKTOP

LIMITED WARRANTY TO ORIGINAL PURCHASER WITH PROOF OF PURCHASE

This Samsung brand product, as supplied and distributed by Samsung ELECTRONICS AMERICA INC. (Samsung) and delivered new, in the original carton to the original consumer purchaser, is warranted by Samsung against manufacturing defects in materials or workmanship for the limited warranty period, starting on the date of delivery to the original consumer purchaser, of:

One (1) Year Parts and Labor

This limited warranty is valid only on products purchased and used in the United States that have been installed, operated, and maintained according to the instructions attached to or furnished with the product. To receive warranty service, the purchaser must contact Samsung at the address or phone number provided below for problem determination and service procedures. Warranty service can only be performed by a Samsung authorized service center. The original dated bill of sale and/or proof of delivery must be presented upon request as proof of purchase to Samsung or Samsung's authorized service center to receive warranty service.

Samsung will provide in-home service within the contiguous United States during the warranty period at no charge, subject to availability of Samsung authorized servicers within the customer's geographic area. If in-home service is not available, Samsung may elect, at its option, to provide transportation of the product to and from an authorized service center. If the product is located in an area where service by a Samsung authorized servicer is not available, you may be responsible for a trip charge or required to bring the product to a Samsung authorized service center for service.

To receive in-home service, product must be unobstructed and accessible to the service agent.

During the applicable warranty period, a product will be repaired, replaced, or the purchase price refunded, at the sole option of Samsung. Samsung may use new or reconditioned parts in repairing a product, or replace the product with a new or reconditioned product. Replacement parts and products are warranted for the remaining portion of the original product's warranty or ninety (90) days, whichever is longer. All replaced parts and products are the property of Samsung and you must return them to Samsung.

This limited warranty covers manufacturing defects in materials or workmanship encountered in normal household, noncommercial use of this product and shall not cover the following: damage that occurs in shipment, delivery, installation, and uses for which this product was not intended; damage caused by unauthorized modification or alteration of the product; product where the original factory serial numbers have been removed, defaced, changed in any way, or cannot be readily determined; cosmetic damage including scratches, dents, chips, and other damage to the product's finishes; damage caused by abuse, misuse, pest infestations, accident, fire, floods, or other acts of nature or God; damage caused by use of equipment, utilities, services, parts, supplies, accessories, applications, installations, repairs, external wiring or connectors not supplied or authorized by Samsung; damage caused by incorrect electrical line current, voltage, fluctuations and surges; damage caused by failure to operate and maintain the product according to instructions; in-home instruction on how to use your product; and service to correct installation not in accordance with electrical or plumbing codes or correction of household electrical or plumbing (i.e., house wiring, fuses, or water inlet hoses). In addition, damage to the glass cooktop caused by (i) use of cleaners other than the recommended cleaners and pads or (ii) hardened spills of sugary materials or melted plastic that are not cleaned according to the directions in the use and care guide are not covered by this limited warranty.

Warranty (U.S.A)

The cost of repair or replacement under these excluded circumstances shall be the customer's responsibility. Visits by an authorized servicer to explain product functions, maintenance or installation are not covered by this limited warranty. Please contact Samsung at the number below for assistance with any of these issues.

EXCLUSION OF IMPLIED WARRANTIES

IMPLIED WARRANTIES, INCLUDING THE IMPLIED WARRANTIES OF MERCHANTABILITY OR FITNESS FOR A PARTICULAR PURPOSE, ARE LIMITED TO ONE YEAR OR THE SHORTEST PERIOD ALLOWED BY LAW. Some states do not allow limitations on how long an implied warranty lasts, so the above limitations or exclusions may not apply to you. This warranty gives you specific rights, and you may also have other rights, which vary from state to state.

LIMITATION OF REMEDIES

YOUR SOLE AND EXCLUSIVE REMEDY IS PRODUCT REPAIR, PRODUCT REPLACEMENT, OR REFUND OF THE PURCHASE PRICE AT Samsung's OPTION, AS PROVIDED IN THIS LIMITED WARRANTY. Samsung SHALL NOT BE LIABLE FOR SPECIAL, INCIDENTAL OR CONSEQUENTIAL DAMAGES, INCLUDING BUT NOT LIMITED TO TIME WAY FROM WORK, HOTELS AND/OR RESTAURANT MEALS, REMODELING EXPENSES, LOSS OF REVENUE OR PROFITS, FAILURE TO REALIZE SAVINGS OR OTHER BENEFITS REGARDLESS OF THE LEGAL THEORY ON WHICH THE CLAIM IS BASED, AND EVEN IF Samsung HAS BEEN ADVISED OF THE POSSIBILITY OF SUCH DAMAGES. Some states do not allow exclusion or limitation of incidental or consequential damages, so the above limitations or exclusions may not apply to you. This warranty gives you specific rights, and you may also have other rights, which vary from state to state.

Samsung does not warrant uninterrupted or error-free operation of the product. No warranty or guarantee given by any other person, firm, or corporation with respect to this product shall be binding on Samsung.

To obtain warranty service, please contact Samsung at:

Samsung Electronics America, Inc.
700 Sylvan Avenue, Englewood Cliffs, NJ 07632
Phone: 1-800-SAMSUNG (726-7864)
Internet: www.samsung.com

Registration

Please register your product online at www.samsung.com/register.

Questions

For questions about features, operation/performance, parts, accessories, or service, call 1-800-SAMSUNG (726-7864), or visit our Web site at www.samsung.com/us/support.

Model # _____

Serial # _____

Please attach your receipt (or a copy) to this manual. You may need it, along with your model and serial number, when calling for assistance.

Warranty (CANADA)

PLEASE DO NOT DISCARD. THE PAGE REPLACES THE WARRANTY PAGE IN THE USE & CARE GUIDE

Samsung GAS RANGE / COOKTOP

LIMITED WARRANTY TO ORIGINAL PURCHASER

This Samsung brand product, as supplied and distributed by Samsung ELECTRONICS CANADA INC. (Samsung) and delivered new, in the original carton to the original consumer purchaser, is warranted by Samsung against manufacturing defects in materials and workmanship for a limited warranty period of:

One (1) Year Parts and Labor

This limited warranty begins on the original date of purchase, and is valid only on products purchased and used in Canada. To receive warranty service, the purchaser must contact Samsung for problem determination and service procedures. Warranty service can only be performed by a Samsung-authorized service center, and any unauthorized service will void this warranty. The original dated bill of sale must be presented upon request as proof of purchase to Samsung or Samsung's authorized service center. Samsung will provide in-home service during the one (1) year warranty period at no charge subject to availability within the contiguous Canada. In-home service is not available in all areas. To receive in-home service, product must be unobstructed and accessible to the service agent. If service is not available, Samsung may elect to provide transportation of the product to and from an authorized service center.

Samsung will repair or replace this product, at our option and at no charge as stipulated herein, with new or reconditioned parts or products if found to be defective during the limited warranty period specified above. All replaced parts and products become the property of Samsung and must be returned to Samsung. Replacement parts and products assume the remaining original warranty, or ninety (90) days, whichever is longer.

This limited warranty shall not cover cases of incorrect electric current, voltage or supply, light bulbs, house fuses, house wiring, cost of a service call for instructions, or fixing installation errors. Furthermore, damage to the cooktop caused by the use of cleaners other than the recommended cleaners and pads and damage to the cooktop caused by hardened spills of sugary materials or melted plastic that are not cleaned according to the directions in the use and care guide are not covered. Samsung does not warrant uninterrupted or error-free operation of the product.

EXCEPT AS SET FORTH HEREIN, THERE ARE NO WARRANTIES OR CONDITIONS ON THIS PRODUCT EITHER EXPRESS OR IMPLIED AND Samsung DISCLAIMS ALL WARRANTIES AND CONDITIONS INCLUDING, BUT NOT LIMITED TO, ANY IMPLIED WARRANTIES AND CONDITIONS OF MERCHANTABILITY, INFRINGEMENT, OR FITNESS FOR A PARTICULAR PURPOSE.

NO WARRANTY OR GUARANTEE GIVEN BY ANY PERSON, FIRM, OR CORPORATION WITH RESPECT TO THIS PRODUCT SHALL BE BINDING ON Samsung.

Samsung SHALL NOT BE LIABLE FOR LOSS OF REVENUE OR PROFITS, FAILURE TO REALIZE SAVINGS OR OTHER BENEFITS, OR ANY OTHER GENERAL, INDIRECT, SPECIAL, INCIDENTAL, OR CONSEQUENTIAL DAMAGES CAUSED BY THE USE, MISUSE, OR INABILITY TO USE THIS PRODUCT, REGARDLESS OF THE LEGAL THEORY ON WHICH THE CLAIM IS BASED, AND EVEN IF Samsung HAS BEEN ADVISED OF THE POSSIBILITY OF SUCH DAMAGES.

NOR SHALL RECOVERY OF ANY KIND AGAINST Samsung BE GREATER IN AMOUNT THAN THE PURCHASE PRICE OF THE PRODUCT SOLD BY Samsung AND CAUSING THE ALLEGED DAMAGE. WITHOUT LIMITING THE FOREGOING, PURCHASER ASSUMES ALL RISK AND LIABILITY FOR LOSS, DAMAGE, OR INJURY TO

Warranty (CANADA)

PURCHASER AND PURCHASER'S PROPERTY AND TO OTHERS AND THEIR PROPERTY ARISING OUT OF THE USE, MISUSE, OR INABILITY TO USE THIS PRODUCT.

THIS LIMITED WARRANTY SHALL NOT EXTEND TO ANYONE OTHER THAN THE ORIGINAL PURCHASER OF THIS PRODUCT, IS NONTRANSFERABLE, AND STATES YOUR EXCLUSIVE REMEDY.

Some states or provinces do not allow limitations on how long an implied warranty lasts, or the exclusion or limitation of incidental or consequential damages, so the above limitations or exclusions may not apply to you.

This warranty gives you specific legal rights, and you may also have other rights which vary from state to state or province to province.

To obtain warranty service, please contact Samsung at:

Samsung Electronics Canada Inc.

2050 Derry Road West, Mississauga, Ontario L5N 0B9 Canada

1-800-SAMSUNG (726-7864) and www.samsung.com/ca/support (English)

www.samsung.com/ca_fr/support (French)

Registration

Please register your product online at www.samsung.com/register.

Questions

For questions about features, operation/performance, parts, accessories, or service, call 1-800-SAMSUNG (726-7864), or visit our Web site at www.samsung.com/ca/support (English), or www.samsung.com/ca_fr/support (French).

Model # _____

Serial # _____

Please attach your receipt (or a copy) to this manual. You may need it, along with your model and serial number, when calling for assistance.

Appendix

Open Source Announcement

The software included in this product contains open source software.

The following URL http://opensource.samsung.com/opensource/SMART_TP1_0/seq/0 leads to open source license information as related to this product.



Security updates information

Security updates are provided to strengthen the security of your device and protect your personal information. For more information on security updates, visit <https://security.samsungda.com>.

* The website supports only some languages.



Scan the QR code* or visit
www.samsung.com/spsn
to view our helpful
How-to Videos and Live Shows
* Requires reader to be installed on your
smartphone

Scan this with your smartphone

QUESTIONS OR COMMENTS?

| COUNTRY | CALL | OR VISIT US ONLINE AT |
|-------------------------------|--------------------------|---|
| U.S.A Consumer Electronics | 1-800-SAMSUNG (726-7864) | www.samsung.com/us/support |
| CANADA | 1-800-SAMSUNG (726-7864) | www.samsung.com/ca/support (English) www.samsung.com/ca_fr/support (French) |

