

# KÄRCHER

makes a difference

## K 5 Premium Full Control Plus

### Operating Instructions

Please read the operating instructions carefully before using the unit.

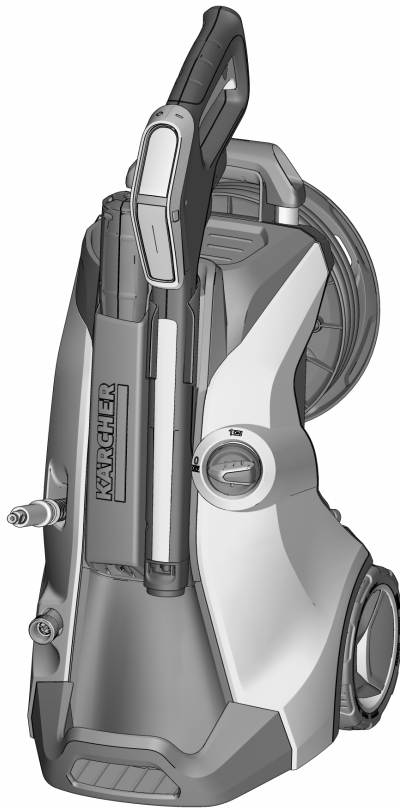

**Register  
your product**

[www.kaercher.com/welcome](http://www.kaercher.com/welcome)

M





59688470 (06/19)

# Contents

|  |    |
|--|----|
| Safety instructions . . . . .          | 3  |
| Description of the Appliance . . . . . | 8  |
| Proper use . . . . .                   | 9  |
| Environmental protection . . . . .     | 9  |
| Assembly . . . . .                     | 10 |
| Start up . . . . .                     | 10 |
| Operation . . . . .                    | 11 |
| Transport . . . . .                    | 12 |
| Storage . . . . .                      | 12 |
| Care and maintenance . . . . .         | 13 |
| Troubleshooting . . . . .              | 13 |
| Accessories and Spare Parts . . . . .  | 14 |
| Warranty . . . . .                     | 14 |
| Customer Service . . . . .             | 14 |
| Technical specifications . . . . .     | 14 |
| Illustration . . . . .                 | 15 |

## Safety instructions

  Please read and comply with these original instructions prior to the initial operation of your appliance and store them for later use or subsequent owners.

Apart from the notes contained herein the general safety provisions and rules for the prevention of accidents of the legislator must be observed.

Warnings and notes that are attached on the appliance provide important notes for the safe operation.

### Hazard levels

#### **DANGER**

Pointer to immediate danger, which leads to severe injuries or death.

#### **WARNING**

Pointer to a possibly dangerous situation, which can lead to severe injuries or death.

#### **CAUTION**

Pointer to a possibly dangerous situation, which can lead to minor injuries.

#### **ATTENTION**

Pointer to a possibly dangerous situation, which can lead to property damage.

## Electric components

### **DANGER**

Risk of electric shock.

- Never touch the mains plug and the socket with wet hands.
- Check the power cord with mains plug for damage prior to every use. Immediately have damaged power cord replaced by an authorised customer service / electrician. Do not operate an appliance if the power cord is damaged.
- All current-conducting parts in the working area must be protected against jet water.
- The mains plug and the coupling of an extension cable must be watertight and must never lie in water. Moreover, the coupling may never lie on the ground. The use of cable reels that ensure that the sockets are at least 60 mm above the ground is recommended.
- Make sure that the power cord or extension cable is not damaged by running over, pinching, dragging or the like. Protect the power cords from heat, oil, and sharp edges.
- Turn off the appliance and remove the mains plug prior to any care and maintenance works.
- Repair work and work on the electrical components may only be performed by an authorised customer service.

## **⚠ WARNING**

- *The appliance may only be connected to an electric supply that has been installed by an electrician in accordance with IEC 60364.*
- *The appliance may only be connected to alternating current. The voltage must correspond with the type plate of the appliance.*
- *Safety class I - Appliances may only be connected to sockets with proper earthing.*
- *For safety reasons, we recommend that you operate the appliance only via a residual current device (max. 30 mA).*
- *An unsuitable electrical extension cable can be hazardous. Only use an electrical extension cable which has been approved and labelled for this purpose and has an adequate cable cross-section outdoors: 1 - 10 m: 1.5 mm<sup>2</sup>; 10 - 30 m: 2.5 mm<sup>2</sup>*
- *Always fully unreel the extension cable from the cable drum.*

## **Safe handling**

### **⚠ DANGER**

- *The user must use the appliance as intended. The person must consider the local conditions and must pay attention to other persons in the vicinity when working with the appliance.*
- *Check important components, such as high-pressure hose, hand spray gun and safety installations, for damage prior to every operation. Immediately replace damaged components. Do not operate appliance with damaged components.*
- *High-pressure jets can be dangerous if improperly used. The jet may not be directed at persons, animals, live electrical equipment or at the appliance itself.*
- *The high-pressure jet must not be directed at other persons or the user him-/herself to clean clothing or footwear.*
- *Vehicle tyres/tyre valves are susceptible to damage from the high-pressure jet and may burst. The first indication for this is a discolouration of the tyre. Damaged vehicle tyres/tyre valves are perilous. Keep a minimum jet distance of 30 cm during cleaning!*

### **⚠ WARNING**

- *Do not use the appliance when there are other persons around unless they are also wearing protective clothing.*
- *The appliance must not be operated by children or persons who have not been instructed accordingly.*
- *This appliance is not intended for use by persons with limited physical, sensory or mental capacities or lacking experience and/or skills, unless such persons are accompanied and supervised by a person in charge of their safety or they have received precise instructions on the use of this appliance and have understood the resulting risks.*
- *Children must not play with this appliance.*
- *Supervise children to prevent them from playing with the appliance.*

### **⚠ CAUTION**

- *Create stability for the appliance prior to any work on or with the appliance to prevent accidents or damage.*
- *The water jet that is emitted from the high-pressure nozzle results in a repulsion power acting on the hand spray gun. Make sure that you have a firm footing and are also holding the hand spray gun and spray lance firmly.*

- *Never leave the appliance unattended as long as it is in operation.*

### **ATTENTION**

- *In case of extended breaks, switch the appliance off at the main switch / appliance switch or pull the mains plug.*
- *Do not operate the appliance at temperatures below 0 °C.*

### **Working with detergent**

#### **⚠ WARNING**

- *This appliance was designed to be used with detergents which are supplied or recommended by the manufacturer. The use of other detergents or chemicals may compromise the safety of the appliance.*
- *The improper use of detergents can cause severe injuries or toxication.*
- *Store detergents away from the reach of children.*

## Other risks

### **⚠ DANGER**

- *The appliance may not be operated in explosive atmospheres.*
- *Never use the appliance to clean objects containing hazardous substances (e.g. asbestos).*
- *Do not spray flammable liquids.*
- *Never draw in fluids containing solvents or undiluted acids and solvents! This includes petrol, paint thinner and heating oil. The spray mist is highly inflammable, explosive and poisonous. Do not use acetone, undiluted acids and solvents, as they corrode the materials used on the appliance.*
- *Keep packaging films away from children, there is a risk of suffocation!*

### **⚠ WARNING**

- *According to applicable regulations, the appliance must never be used on the drinking water net without a system separator. Ensure that the connection of your building water installation on which the high-pressure cleaner is operated is equipped with a system separator pursuant to EN 12729 Type BA.*

- *Water that has flown through a system separator is no longer classified as drinking water.*
- *High-pressure hoses, fixtures and couplings are important for the safety of the appliance. Only use high-pressure hoses, fixtures and couplings recommended by the manufacturer.*
- *When disconnecting the supply or high pressure hose, hot water may leak from the connections after operation.*

### **⚠ CAUTION**

- *Mind the weight of the appliance when selecting the storage location and during transport (see technical data) to prevent accidents or injuries.*
- *Several hours of continuous use of the appliance can lead to numbness in the hands in rare cases.*
- ➔ *Wear gloves.*
- ➔ *Keep hands warm.*
- ➔ *Take breaks at regular intervals.*

## Safety Devices

### CAUTION

- Safety installations serve the protection of the user and may not be modified or bypassed.

### Power switch

The appliance switch prevents unintentional operation of the appliance.

### Lock trigger gun

This lock locks the lever of the trigger gun and prevents the inadvertent start of the appliance.

### Overflow valve with pressure switch

If the lever on the trigger gun is released the pressure switch turns off the pump, the high pressure jet is stopped. If the lever is pulled the pump is turned on again.

### Motor protection switch

The motor protection switch switches off the device if the power consumption is high.

## Symbols on the machine



The high pressure jet must not be directed at persons, animals, live electrical equipment or at the appliance itself. Protect the appliance against frost.



The appliance must not be directly connected to the public drinking water network.

## Personal protective equipment

### CAUTION

- Wear protective clothing and safety goggles to protect against splash back containing water or dirt.
- During the use of high-pressure cleaners aerosols can develop. Inhaling aerosols can cause health damage.
  - Depending on the application, completely shielded nozzles (e.g. surface cleaner) that significantly reduce the emission of aqueous aerosols can be used for high-pressure cleaning.
  - The use of such shielding is not possible with all applications.
  - If the use of a completely shielded nozzle is not possible, a respirator of the category FFP 2 or the like should be used, depending on the environment to be cleaned.

# Description of the Appliance

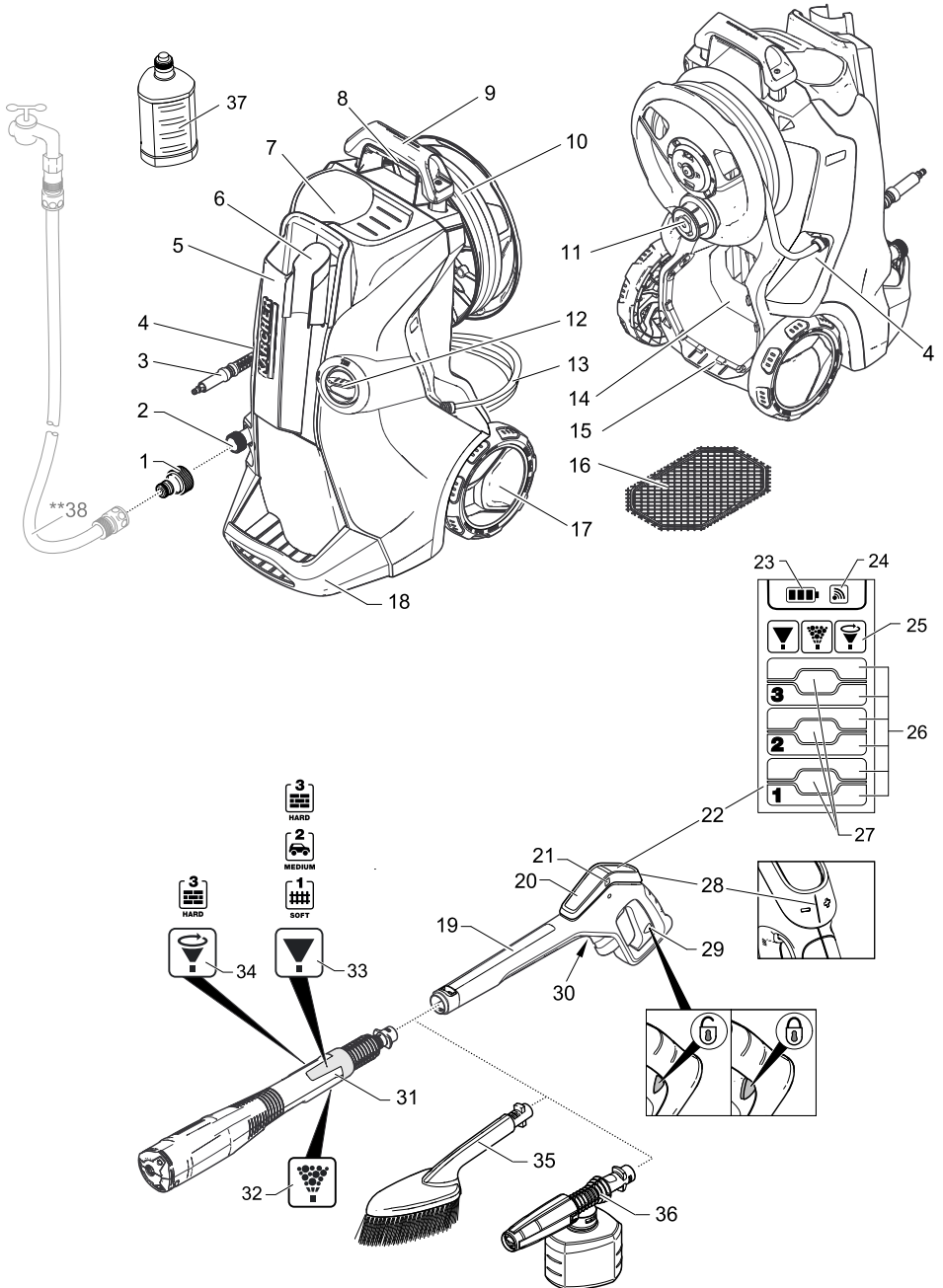

## Description of the Appliance

The scope of delivery of the device (depending on the model) is illustrated on the packaging. These operating instructions describe all possible options.

- 1 Coupling element for water connection
- 2 Water connection with integrated sieve
- 3 High pressure hose
- 4 Hose guide
- 5 Storage for spray lance
- 6 Storage / parking position for trigger gun
- 7 Connection for Plug 'n' Clean detergent
- 8 Carrying handle
- 9 Transport handle, detachable
- 10 High-pressure hose drum
- 11 Hand crank for hose drum
- 12 Appliance switch „0/OFF“ / „I/ON“
- 13 Mains cable with mains plug
- 14 Accessory compartment
- 15 Hooks for fastening the net
- 16 Net for accessory compartment
- 17 Bearing wheel
- 18 Base with carrying handle
- 19 Full Control trigger gun
- 20 Battery compartment
- 21 Battery compartment lock
- 22 LCD display
- 23 Battery status (empty, almost empty, medium, full)
- 24 Signal strength status (four levels)
- 25 Spray type recommendation (flat stream/detergent/dirt blaster)
- 26 Area of application (1 - SOFT / 2 - MEDIUM / 3 - HARD with two pressure levels each)
- 27 Detergent level (1 / 2 / 3)
- 28 Pressure regulation + / -
- 29 Lock trigger gun
- 30 Button for detaching the high-pressure hose from the trigger gun
- 31 3-in-1 multi jet spray lance (with three spray types)
- 32 Detergent nozzle (three dosing levels) - For dosing detergents
- 33 Flat jet nozzle (three areas of application with two pressure levels each) - for the most common cleaning tasks.
- 34 Dirt blaster (one area of application with two pressure levels) - for stubborn contamination.
- 35 Washing brush
- 36 Foam nozzle with detergent container  
With powerful foam for effortless cleaning.
- 37 Plug 'n' Clean detergent bottle with locking lid

### \*\* Additionally required

- 38 Fabric-reinforced water hose with commercially available coupling.
  - Minimum diameter, 1/2 inches (13 mm).
  - Minimum length 7.5 m.

## Proper use

- Use this pressure washer for private households only:
- for cleaning machines, vehicles, buildings, tools, facades, terraces, gardening tools, etc. by means of a high-pressure water jet (if necessary, with additional cleaning agents).
  - with accessories, replacement parts and cleaning agents approved by KÄRCHER. Please observe the information accompanying the cleaning agents.

## Environmental protection

### Notes about the ingredients (REACH)

You will find current information about the ingredients at:

[www.kaercher.com/REACH](http://www.kaercher.com/REACH)



The packaging material can be recycled. Please arrange for the environmentally appropriate disposal of the packaging.



Electrical and electronic devices often contain components which could potentially pose a danger to human health and the environment if handled or disposed of incorrectly. However, these components are necessary for the proper operation of the device. Devices marked with this symbol must not be disposed of with regular household rubbish.

Old appliances contain valuable recyclable materials that should be recycled properly. Batteries and accumulators contain substances that must not enter the environment. Please dispose of old devices and batteries or accumulators in an environmentally friendly way.



Cleaning operations which produce oily waste water, e.g. engine washes, underbody washes, may only be carried out using washing stations equipped with an oil separator.



Work with detergents must only be performed on liquid-tight work surfaces with a connection to the sewer system. Do not let release detergent into waters or earth.



The extraction of water from public waters is prohibited in some countries.

## Assembly

### Illustrations on Page 15

Mount loose parts delivered with appliance prior to start-up.

You will need the 2 included screws as well as a Philips screwdriver PH 2.

### Install wheels

#### Illustration **A**

- Secure the wheels using the included plug. Align the plug properly!
- Insert the cover and screw in.

### Installing the base

#### Illustration **B**

- Insert base.
- Insert the included dowels all the way into the holes.
- Secure the base with the enclosed screws.

### Install storage for spray lance

#### Illustration **C**

- Hook in storage for spray lance.
- Secure the storage for the spray lance by means of two screws.

### Install the transport handle

#### Illustration **D**

- Attach the transport handle.
- Secure the transport handle by means of two screws.

### Attach the net to the accessory compartment

#### Illustration **E**

- Hook the net into the hooks shown in the illustration.

### Coupling of the high-pressure gun

Before **initial** startup, the high-pressure gun must be coupled to the high-pressure cleaner.

- Insert the mains plug into the socket.
- Within one minute, simultaneously press the + and - buttons on the high-pressure gun.
- Hold down the buttons until the entire signal strength symbol flashes. Once coupling is complete, all six pressure levels will be displayed.

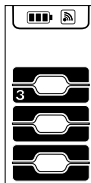

**Note:** You can find a detailed description of the coupling here: <https://www.kaercher.com/FCR>

## Start up

- Park the appliance on an even surface.

#### Illustration **F**

- Put the high-pressure hose through the hose guide from the back.

#### Illustration **G**

- Push the high pressure hose into the trigger gun until it locks audibly.

**Note:** Make sure the connection nipple is aligned correctly.

Check the secure connection by pulling on the high pressure hose.

- Unwind the high pressure hose from the hose drum.
- Insert the mains plug into the socket.

### Water supply

For connection values, see type plate/technical data.

#### **ATTENTION**

*Impurities in the water can damage the high-pressure pump and the accessories. For protection, the use of the KÄRCHER water filter (optional accessory, order no. 4.730-059) is recommended.*

#### Water supply from mains

Observe regulations of water supplier.

#### **ATTENTION**

*Hose couplings made of metal with aquastop can damage the pump! Please use plastic couplings or KÄRCHER brass couplings.*

#### Illustration **H**

- Screw the coupling element to the water connection on the appliance.
- Attach the water supply hose to the coupling on the water connection.
- Connect the water supply hose to the water supply.
- Completely open the water tap.

#### Drawing in water from open reservoirs

This high-pressure cleaner is suited to work with the KÄRCHER suction hose with backflow valve (Optional accessory, order no. 2.643-100) to draw in surface water, e.g. from water butts or ponds (see specifications for max. suction height).

**Note:** With vacuuming operation, the coupling for the water connection is not required.

- Fill the suction hose with water.
- Screw the suction hose into the water connection of the appliance and insert it into the water source (e.g. rainwater drum).

#### Bleed the device as follows prior to operation:

- Turn on the appliance "I/ON".
- Unlock the lever of the trigger gun.
- Push the lever of the trigger gun, the device will switch on.
- Using the +/- buttons, set the high-pressure gun to detergent level 1.
- Let the device run (max. 2 minutes) until the water exits the trigger gun without bubbles.
- Release the lever of the trigger gun.
- Lock the lever of the trigger gun.

## Operation

### ATTENTION









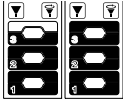

Dry running of more than 2 minutes leads to damage of the high-pressure pump. If the appliance does not build up pressure within 2 minutes, switch the appliance off and proceed in accordance with the instructions in Chapter "Troubleshooting".

### Full Control Plus System

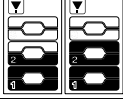
The +/- buttons on the high-pressure gun can be used to select the pressure and detergent dosing levels. It is possible to change spray type by turning the 3-in-1 multi jet spray lance.

### ATTENTION

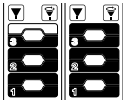
The sensitivity of the materials can strongly differ depending on the age and the condition. The so-called recommendations are non-binding.

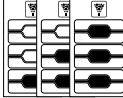
| Pressure level   | For example, recommended for  |
|--|---|
|  <b>Flat jet nozzle</b>    |   |
|                            |  Stone terraces, asphalt, metal surfaces, garden utensils (wheelbarrow, spade, etc.)   |
|                            |  Motorcar / motorcycle, brick surfaces, plastered walls, plastic furniture   |
|                            |  Wooden surfaces, bicycles, sand stone surfaces, rattan furniture  |
|  <b>Dirt blaster</b>       |   |
|                            |  For especially <b>stubborn dirt</b> on stone terraces, asphalt, metal surfaces, garden utensils (wheelbarrow, spade, etc.) |
|  <b>Detergent nozzle</b> |   |
|                          |  Operation with detergent. Dosing the detergent concentration as needed.   |

**Note:** When working with T-Racers and other accessories, the pressure indicator is not indicative. So that correct function is guaranteed, always set the pressure on the high-pressure gun to the highest level. Make any possible adjustments directly on the accessories.

## High pressure operation

### ⚠ CAUTION

Keep a distance of at least 30 cm when using the jet for cleaning painted surfaces to avoid damage.

### ATTENTION

Car tyres, paint or sensitive surfaces such as wood should not be cleaned with the dirt blaster, as there is a risk of damage.

### Illustration

- Push the 3-in-1 multi jet spray lance into the high-pressure gun and fasten it by a 90° rotation (observe alignment!).
- Select spray type, by turning the 3-in-1 multi jet spray lance until the required spray display is visible above.
- Turn on the appliance "I/ON".
- Unlock the lever of the trigger gun.
- Push the lever of the trigger gun, the device will switch on.

**Note:** Release the lever of the trigger gun; the device will switch off again. High pressure remains in the system.

## Operation with washing brush

### ATTENTION

*Risk of damage to the paintwork*

When working with the washing brush, it must be free of dirt or other particles.

- Push the washing brush into the trigger gun and fasten it by a 90° turn.

**Note:** If required, the washing brushes can be used to work with detergent.

## Operation with detergent

Most KÄRCHER detergents can be bought ready to use in a Plug 'n' Clean detergent bottle.

### ⚠ DANGER

When using detergents, the material data safety sheet issued by the detergent manufacturer must be adhered to, especially the instructions regarding personal protective equipment.

**Note:** Detergent can only be added when the device is operated in low pressure mode.

### Illustration

- Remove the cap of the Plug 'n' Clean detergent bottle.
  - Push the detergent bottle with the opening pointing downwards into the connection for the Plug 'n' Clean detergent.
  - Turn the 3-in-1 multi jet spray lance to detergent nozzle "MIX".
- Note:** This will mix the detergent with the water stream.
- Using the +/- buttons of the high-pressure gun, set the desired detergent concentration.

## Foam nozzle

- Fill the detergent solution in the detergent tank of the foam nozzle (observe dosage instructions on the packaging of the detergent).
- Connect the detergent tank to the foam nozzle.
- Connect the foam nozzle to the trigger gun.

## Recommended cleaning method

- Spray the detergent sparingly on the dry surface and allow it to react, but not to dry.
- Spray off loosened dirt with the high pressure jet.

## After operation with detergent

- Remove the Plug 'n' Clean detergent bottle from the intake and close it with the lid.
- For storage, put the detergent bottle into the retainer with the cap pointing up.
- To rinse, operate the device for about 30 seconds in detergent level 1.

## Interrupting operation

- Release the lever of the trigger gun.
  - Lock the lever of the trigger gun.
- Illustration **K**
- Put the trigger gun with the spray lance into the parking position.
  - During longer breaks (more than 5 minutes), also turn the appliance off using the "0/OFF" switch.

## Finish operation

### ⚠ CAUTION

Only separate the high-pressure hose from the trigger gun or the device when there is no pressure in the system.

### ATTENTION

When disconnecting the supply or high pressure hose, warm water may leak from the connections after operation.

- Release the lever of the trigger gun.
- Turn off tap.
- Press the lever of the high-pressure gun for 30 seconds to release any remaining pressure in the system.
- Release the lever of the trigger gun.
- Lock the lever of the trigger gun.
- Detach the appliance from the water supply.
- Turn off the appliance "0/OFF".
- Disconnect the mains plug from the socket.

## Transport

### ⚠ CAUTION

Risk of personal injury or damage!  
Mind the weight of the appliance during transport.

## When transporting by hand

- Lift appliance by the carrying handle and carry it.
- Pull out the transport handle until it audibly snaps into place.  
Pull the appliance by its transport handle.

## When transporting in vehicles

- Prior to horizontal transport: Remove the Plug 'n' Clean detergent bottle from the intake and close it with the lid.
- Secure the appliance against shifting and tipping over.

## Storage

### ⚠ CAUTION

Risk of personal injury or damage!  
Consider the weight of the appliance when storing it.

## Storing the Appliance

- Park the machine on an even surface.
- Detach spray lance from the trigger gun.
- Push the disconnect button on the trigger gun and pull the high-pressure hose out of the trigger gun.
- Place the trigger gun into the storage for the trigger gun.
- Put the 3-in-1 multi jet spray lance into the storage for the spray lance.
- Store the mains connection in the accessory compartment.

### ⚠ CAUTION

Risk of personal injury or damage!  
Observe the rotation direction of the hose reel upon coiling up the high-pressure hose.

- Coil up the high-pressure hose.  
Turn the hose reel in a **counter-clockwise direction** using the crank handle.

Prior to extended storage periods, as during the winter, also observe the instructions in the Care section.

## Frost protection

### ATTENTION

Appliances and accessories that are not completely drained can be destroyed by frost. Completely drain appliance and accessories and protect them against frost.

To avoid damage:

- Detach the appliance from the water supply.
- Detach spray lance from the trigger gun.
- Turn on the appliance "I/ON".
- Push the lever of the trigger gun until no more water is escaping (approx. 1 min).
- Release the lever of the trigger gun.
- Lock the lever of the trigger gun.
- Turn off the appliance "0/OFF".
- Store the appliance and the entire accessories in a frost free room.

## Care and maintenance

### ⚠ **DANGER**

*Risk of electric shock.*

- ➔ Prior to all work on the appliance, switch off the appliance and pull the power plug.

### Clean the sieve in the water connection

Clean the sieve in the water connection regularly.

- ➔ Remove coupling from the water connection.

### **ATTENTION**

*The sieve must not be damaged.*

Illustration **L**

- ➔ Pull the sieve out using flat pliers.
- ➔ Clean the sieve under running water.
- ➔ Reinsert the sieve into the water connection.

### Changing the batteries of the trigger gun

The batteries are depleted if nothing or the following is shown on the display of the high-pressure gun.

Two batteries or accumulators of the size AAA are required.

Illustration **M**

- ➔ Push the locking slide.
- ➔ Open battery compartment.
- ➔ Remove the batteries.
- ➔ Insert new batteries and observe the correct orientation of the terminals.
- ➔ Close battery compartment.
- ➔ Dispose of the used batteries according to the local provisions.



## Troubleshooting

### ⚠ **DANGER**

*Risk of electric shock. Turn off the appliance and remove the mains plug prior to performing any care and maintenance work.*

*Repair work and work on the electrical components may only be performed by an authorised customer service. You can rectify minor faults yourself with the help of the following overview.*

If in doubt, please consult the authorized customer service.

### Appliance is not running

- ➔ Push the lever of the trigger gun, the device will switch on.
  - ➔ Check whether the voltage indicated on the type plate corresponds to the voltage of the mains supply.
  - ➔ Check the mains connection cable for damages.
  - ➔ Motor overloaded, the motor circuit breaker has tripped.
    - Turn off the appliance "0/OFF".
    - Allow the device to cool down for **one hour**.
    - Switch on the device and put it into operation again.
- If the malfunction occurs repeatedly, have the device checked by the customer service.

### Appliance does not start, motor hums

Voltage reduction due to weak mains supply or when using an extension cable.

- ➔ Upon switch-on, push the lever of the trigger gun first and then switch the power switch to "I/ON".

### Pressure does not build up in the appliance

- ➔ Check setting at the spray lance.
- ➔ Check water supply for adequate delivery rate.
- ➔ Pull out the sieve in the water connection using flat-nose pliers and clean under running water.
- ➔ Remove air from appliance before operation. Switch on the appliance without connection the HP hose (max. 2 minutes) and run it until the water discharging from the HP outlet is free of bubbles. Switch off appliance and reconnect HP hose.

### Strong pressure fluctuations

- ➔ Clean high-pressure nozzle: Remove dirt and debris from the nozzle bore, using a needle and rinse through with water from the front.
- ➔ Check water flow quantity.

### Appliance is leaking

- ➔ Dropwise leakage of the device is normal for technical reasons. If the leakage increases contact the authorized customer service.

### No detergent infeed

- ➔ Turn the 3-in-1 multi jet spray lance to detergent nozzle "MIX".
- ➔ Check whether the Plug 'n' Clean detergent bottle is placed into the detergent connection facing down.

### No pressure indicator on the trigger gun

- ➔ Check / replace the batteries
- ➔ Decrease the distance between high-pressure gun and high-pressure cleaner.
- ➔ Couple it to the high-pressure cleaner again.

### Error messages

- ➔ Switch off the device and pull the mains plug out of the socket.
- ➔ After 20 seconds, insert the power cord back into the socket and switch the device on.

If the malfunction occurs repeatedly, have the device checked by the customer service.

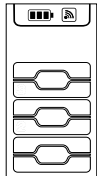

### Emergency operation

If the pressure regulation on the high-pressure gun is defective (electronic defect, battery empty, etc.), the high-pressure cleaner continues operating at the level that was last set.

To activate emergency operation at the maximum level:

- ➔ Switch off the device and pull the mains plug out of the socket.
- ➔ Insert the power cord back into the socket and switch the device on.

## Accessories and Spare Parts

Only use original accessories and spare parts, they ensure the safe and trouble-free operation of the device. For information about accessories and spare parts, please visit [www.kaercher.com](http://www.kaercher.com).

## Warranty

The warranty terms published by the relevant sales company are applicable in each country. We will repair potential failures of your appliance within the warranty period free of charge, provided that such failure is caused by faulty material or defects in manufacturing. In the event of a warranty claim please contact your dealer or the nearest authorized Customer Service centre. Please submit the proof of purchase. Addresses can be found under:

[www.kaercher.com/dealerearch](http://www.kaercher.com/dealerearch)

## Customer Service

### Australia

KÄRCHER Pty. Ltd.  
385 Ferntree Gully Road,  
Mount Waverley, Victoria, AU. 3149

1800 675 714 (Free Call)  
[www.karcher.com.au](http://www.karcher.com.au)

## Technical specifications

### Electrical connection

|                        |                      |
|------------------------|----------------------|
| Voltage                | 230-240 V<br>1~50 Hz |
| Connected load         | 2,1 kW               |
| Type of protection     | IPX5                 |
| Protective class       | I                    |
| Mains fuse (slow-blow) | 16 A                 |

### Water connection

|                       |          |
|-----------------------|----------|
| Max. feed pressure    | 1,2 MPa  |
| Max. feed temperature | 40 °C    |
| Min. feed volume      | 10 l/min |
| Max. Suction height   | 0,5 m    |

### Performance data

|                                 |                    |
|---------------------------------|--------------------|
| Working pressure                | 12,5 MPa           |
| Max. permissible pressure       | 16 MPa<br>2300 psi |
| Water flow rate                 | 7,5 l/min          |
| Max. flow rate                  | 8,3 l/min          |
| Detergent flow rate             | 0,3 l/min          |
| Recoil force of the trigger gun | 17 N               |

### Dimensions and weights

|   |         |
|---|---------|
| Length                                    | 411 mm  |
| Width                                     | 305 mm  |
| Height                                    | 584 mm  |
| Weight, ready to operate with accessories | 15,8 kg |

Subject to technical changes.

# Illustration

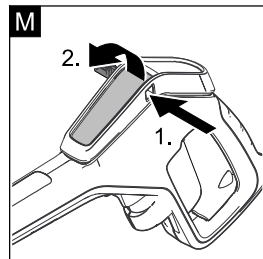
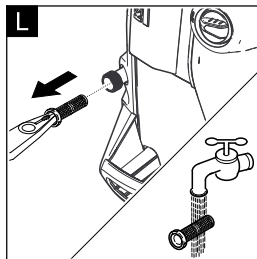
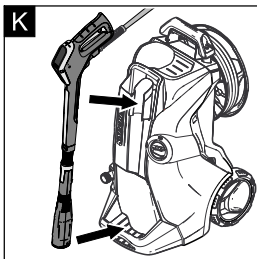
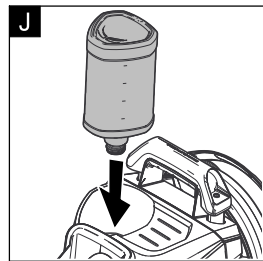
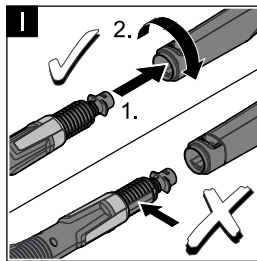
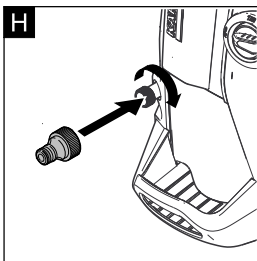
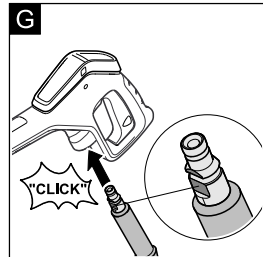
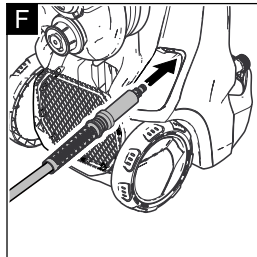
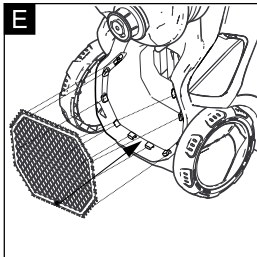
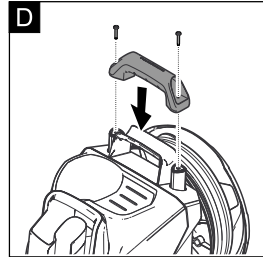
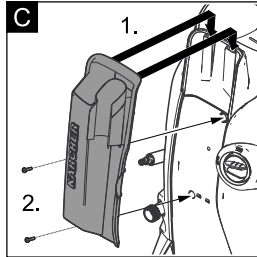
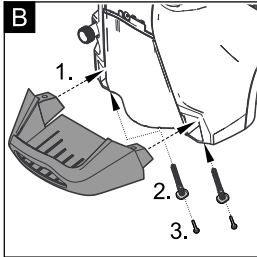
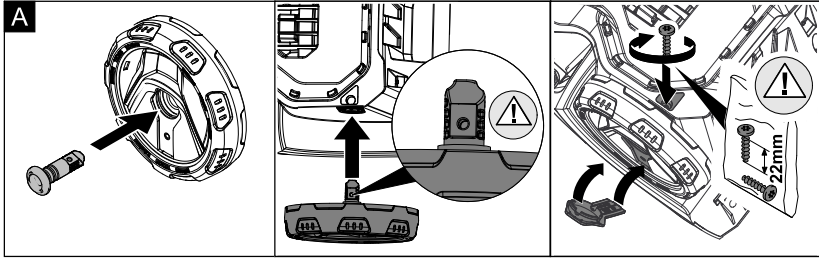



**THANK YOU!**  
**MERCI! DANKE! ¡GRACIAS!**



Registrieren Sie Ihr Produkt und profitieren Sie von vielen Vorteilen.

Register your product and benefit from many advantages.

Enregistrez votre produit et bénéficiez de nombreux avantages.

Registre su producto y aproveche de muchas ventajas.

**[www.kaercher.com/welcome](http://www.kaercher.com/welcome)**



Bewerten Sie Ihr Produkt und sagen Sie uns Ihre Meinung.

Rate your product and tell us your opinion.

Évaluer votre produit et dites-nous votre opinion.

Reseñe su producto y díganos su opinión.



**[www.kaercher.com/service](http://www.kaercher.com/service)**

**Alfred Kärcher SE & Co. KG**  
Alfred-Kärcher-Str. 28-40  
71364 Winnenden (Germany)  
Tel.: +49 7195 14-0  
Fax: +49 7195 14-2212

