

Watch Operation Guide 5743

CASIO®

Contents

About This Watch

General Guide

Watch Face Items

Navigating Between Modes

Mode Overview

Using the Crown

Hand and Day Indicator Movement

Charging

Viewing the Face in the Dark

Useful Features

Linking with a Phone

Getting Ready

Auto Time Correction

Configuring World Time Settings

Setting the Alarm

Configuring Timer Settings

Correcting Hand and Day Indicator Alignment

Phone Finder

Configuring Watch Settings

Changing the Home City Summer Time Setting

Checking the Watch Charge Level

Recording Your Current Location
(TIME&PLACE)

Connection

Connecting with a Phone

Disconnecting from Your Phone

Using the Watch in a Medical Facility or
Aircraft

Unpairing

If you purchase another phone

Time Adjustment

Time Adjustment Using a Time Signal

Overview

Appropriate Signal Reception Location

Time Signal Reception Ranges

Auto Time Calibration Signal Receive

Manual Time Calibration Signal Receive

Signal Reception Precautions

Using Watch Operations to Correct the Time
Setting

Checking the Last Time Correction Result

Using the Watch in a Medical Facility or
Aircraft

World Time

Using the CASIO WATCHES Phone App to
Configure World Time City Settings

Specifying a World Time City

Configuring the Summer Time Setting (World
Time)

Swapping Your Home City Time and World
Time

Moving Between Time Zones

Alarm

Using the CASIO WATCHES Phone App to
Configure Alarm Settings

Configuring Alarm Settings

Turning Off the Alarm

Stopwatch

Measuring Elapsed Time

Timer

Using the CASIO WATCHES Phone App to
Configure Timer Settings

Setting the Timer Start Time

Using the Timer

Hand and Day Indicator Alignment

Using the CASIO WATCHES Phone App to
Adjust Hand and Day Indicator Alignment

Adjusting Hand and Day Indicator Alignment

Other Settings

Resetting Watch Settings

Specifications

Other Information

City Table

Summer Time Table

Supported Phones

Copyrights and Registered Copyrights

Troubleshooting

Precautions

Operating Precautions

User Maintenance

Battery

Mobile Link Precautions

About This Watch

This section provides an overview of the watch and introduces convenient ways it can be used.

Watch Features

- **Phone Linking**

The watch supports connection and communication with a Bluetooth capable phone.

- **Solar Charging**

Sunlight and artificial light generate electricity for watch operation as it charges.

- **Time Signal Reception**

The watch receives a radio signal containing time information and uses it to keep its time setting accurate.

- **World Time**

Displays the current time in any one of 27 cities (38 time zones) around the globe and UTC.

- **Alarm**

A beeper sounds when the alarm time you set is reached.

- **Stopwatch**

You can use the stopwatch to measure up to 24 hours of elapsed time in 1-second units.

- **Timer**

Countdown from a start time specified by you. An alarm sounds when the countdown reaches zero.

Note

- The illustrations included in this operation guide have been created to facilitate explanation. An illustration may differ somewhat from the item it represents.

General Guide

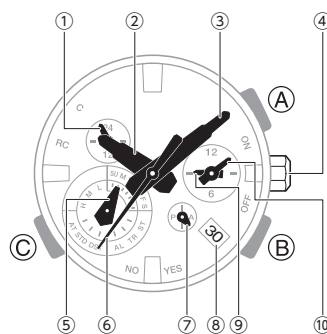

- ① 24-hour hand
- ② Hour hand
- ③ Minute hand
- ④ Crown
- ⑤ Mode hand
- ⑥ Second hand
- ⑦ Small 24-hour hand
- ⑧ Day indicator
- ⑨ Small hour hand
- ⑩ Small minute hand

A button

In the Calendar Mode or Alarm Mode, press this button to illuminate the face.

B button

Pressing this button causes the second hand to indicate the last receive operation result.

C button

Each press cycles between watch modes. Holding down this button for at least one second in any mode enters the Calendar Mode.

Watch Face Items

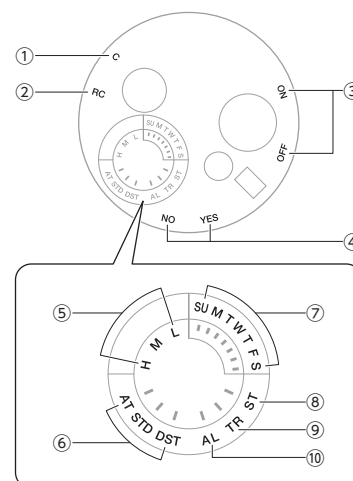

- ① [C]
The second hand will point to [C] if the watch is connected with a phone.
- ② [RC]
The second hand points to this mark while calibration signal reception is in progress.
- ③ Alarm on/off setting
In the Alarm Mode, the second hand indicates if the alarm is enabled or disabled.
[ON]: Alarm enabled
[OFF]: Alarm disabled
- ④ Last receive result/Auto time correction setting
The second hand points to [Y(YES)] or [N(NO)] to indicate the result of the last auto time correction operation based on time signal reception or connection with a phone.
[Y(YES)]: Auto time correction successful
[N(NO)]: Auto time correction failed
The second hand indicates whether auto time correction is enabled or disabled.
[Y(YES)]: Auto time correction enabled
[N(NO)]: Auto time correction disabled

⑤ Battery level

The battery level is indicated by the mode hand after you enter the Calendar Mode.

⑥ Summer time setting

The mode hand points to the current summer time setting.

⑦ Day of week

In the Calendar Mode, the mode hand points to the day of the week in the Home City.

⑧ [ST]

In the Stopwatch Mode, the mode hand points to [ST].

⑨ [TR]

In the Timer Mode, the mode hand points to [TR].

⑩ [AL]

In the Alarm Mode, the mode hand points to [AL].

Navigating Between Modes

Each press of (C) cycles between watch modes.

- Hold down (C) for at least one second to enter the Calendar Mode.

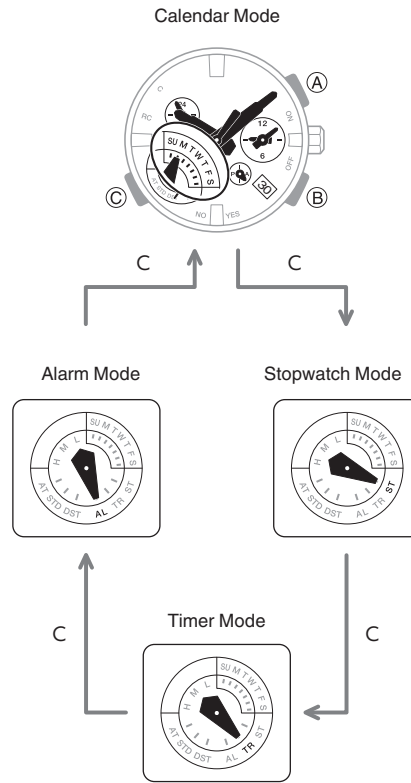

- After you enter the Calendar Mode, the mode hand first indicates the battery charge level and then the current day of the week.

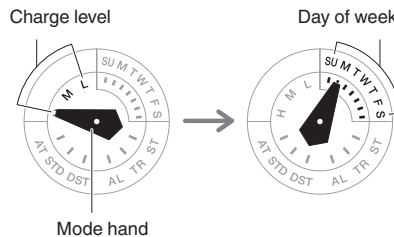

• Connecting with a Paired Phone

Hold down (C) for at least 2.5 seconds to connect with a phone.

- To disconnect, press any button.

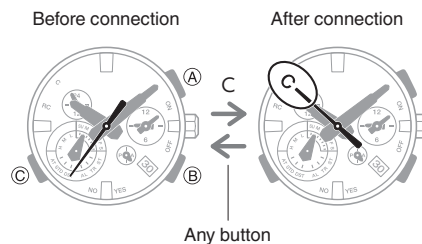

Mode Overview

• Calendar Mode

The main hour, minute, and second hands indicate the current time.

The small hour and minute hands indicate the current World Time.

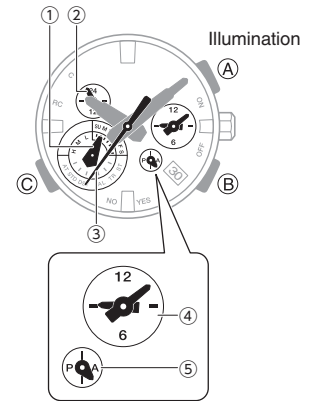

- Day of the week at current location
- Current location 24-hour time
One revolution every 24 hours.
- Current location seconds
- World Time
- World Time 24-hour time
The hand points to the A-side for a.m. times, and to the P-side for p.m. times.

Swapping the Current Location Time and World Time

Hold down (A) for at least three seconds.

Time Adjustment Using a Time Calibration Signal

Hold down (B) for at least 0.5 seconds until the second hand points to [RC].

- A manual time calibration signal receive operation cannot be performed while the watch is paired with a phone.

Connecting with a Paired Phone to Correct the Watch's Time

Hold down (B) for at least 0.5 seconds until the second hand points to [C].

Searching for a Paired Phone

Hold down (B) for at least 3.5 seconds until the second hand points to [C].

● Stopwatch Mode

The main hour and minute hands indicate the current time.

The second hand, and the small hour and minute hands indicate the elapsed stopwatch time.

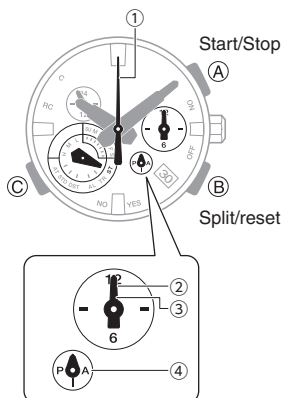

- ① Stopwatch seconds
- ② Stopwatch minutes
- ③ Stopwatch hours
- ④ Stopwatch 24-hour hand

The hand points to the A-side for hours 0 through 11, and to the P-side for hours 12 through 23.

● Timer Mode

The main hour and minute hands indicate the current time.

The second hand, and the small hour and minute hands indicate the current countdown time.

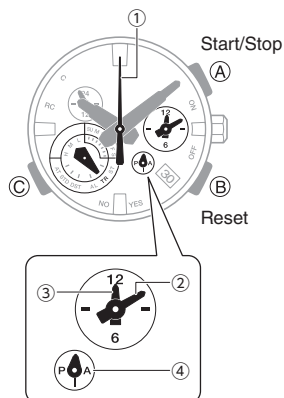

- ① Timer seconds
- ② Timer minutes
- ③ Timer hours
- ④ Timer 24-hour hand

The hand points to the A-side for hours 0 through 11, and to the P-side for hours 12 through 23.

● Alarm Mode

The main hour and minute hands indicate the current time.

The small hour and minute hands indicate the alarm time.

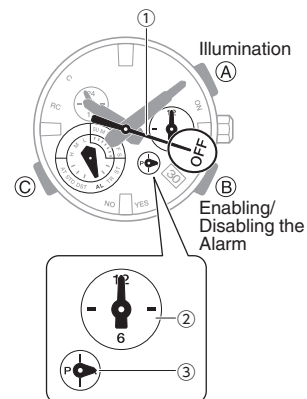

- ① Alarm enabled/disabled
- ② Alarm time
- ③ Alarm 24-hour hand
The hand points to the A-side for a.m. times, and to the P-side for p.m. times.

Using the Crown

The watch's crown is a screw-in (screw lock) type. To use the crown, you first need to rotate it towards you (leftwards) to loosen it.

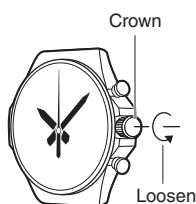

Important!

- To prevent loss of water resistance and/or damage due to impact, be sure to screw the crown in by rotating it away from you as you push it in.

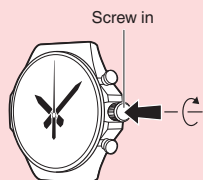

- When pushing the crown back in, take care not to apply too much force.

● Fast Forward/Fast Reverse

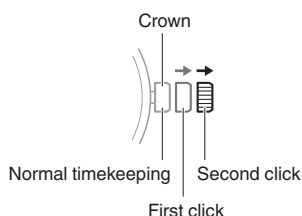

After pulling out the crown to the first or second click, rotating it quickly in succession in either direction will start a fast forward or fast reverse operation. While a fast forward operation is in progress, quickly rotating the crown in succession again will increase the speed even further.

● Stopping Fast Forward/Fast Reverse

Rotate the crown in the direction opposite that of the ongoing operation or press any button.

Note

- If you do not perform any operation for about two minutes after pulling out the crown, crown operations will automatically become disabled. If that happens, push the crown back in and then pull it out again.

Hand and Day Indicator Movement

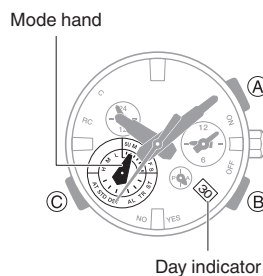

● Mode Hand and Day Indicator Movement

Changing the day setting of the watch will also cause the mode hand to move.

● Day

- It can take anywhere from about 10 to 40 seconds for the day indicator to change after timekeeping reaches midnight. The mode hand moves as the day indicator changes.
- The day may not be indicated correctly while the watch's crown is pulled out.

Charging

This watch runs on power supplied from a rechargeable (secondary) battery that is charged by a solar panel. The solar panel is integrated into the face of the watch, and power is generated whenever the face is exposed to light.

● Charging the Watch

When you are not wearing the watch, put it in a location where it is exposed to bright light.



While you are wearing the watch, make sure that its face (solar panel) is not blocked from light by the sleeve of your clothing. Power generation efficiency is reduced even when the face of the watch is blocked only partially.

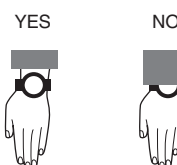

Important!

- Some light sources and environments can cause the watch to become extremely hot during charging, which creates the risk of burn injury and damage to internal watch components. Avoid charging the watch under conditions like the ones described below, where the temperatures may exceed 60 °C (140 °F).
 - On the dashboard of a vehicle parked in the sun
 - Near incandescent lamps, camera lights, halogen lamps, or other sources of heat
 - In locations exposed to direct sunlight for long periods and other hot locations

● Checking the Charge Level

Immediately after you press (C) to return to the Calendar Mode, the mode hand will indicate the battery charge level. After a short while, the mode hand will indicate the current day of the week.

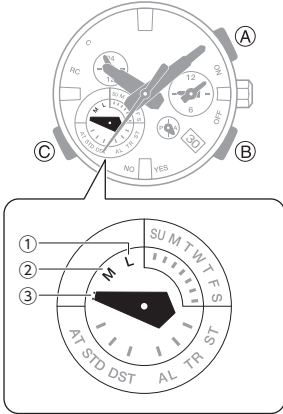

- ① Low Battery
- ② Good (medium charge)
- ③ Good (high charge)

● Remaining Charge and Dead Battery

You can determine if the charge level is low by checking the hand movement. Functions become disabled as battery power goes low.

Important!

- Should the battery go low or go dead, expose the face (solar panel) to light as soon as possible.

Note

- Exposing the watch face to light after the battery goes dead will cause the second hand to revolve counterclockwise until it stops at second 57. This indicates charging has started.

Low Battery Power

The second hand jumps at two-second intervals.



Dead Battery

All hands and the day indicator are stopped.

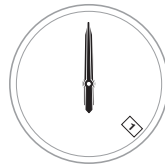

● Charging Time Guidelines

The table below shows guidelines for approximate charging times.

Charging Times Required for 1 Day of Operation

Light Level (Lux)	Approximate Charging Time
50,000	8 minutes
10,000	30 minutes
5,000	48 minutes
500	8 hours

Charge Recovery Times

- Sunny day, outdoors (50,000 lux)

Dead battery → Medium charge	2 hours
Medium charge → High charge	17 hours
High charge → Full charge	5 hours

- Sunny day, near a window (10,000 lux)

Dead battery → Medium charge	5 hours
Medium charge → High charge	63 hours
High charge → Full charge	17 hours

- Overcast day, near a window (5,000 lux)

Dead battery → Medium charge	8 hours
Medium charge → High charge	102 hours
High charge → Full charge	28 hours

- Indoor fluorescent lighting (500 lux)

Dead battery → Medium charge	90 hours
Medium charge → High charge	-
High charge → Full charge	-

Note

- Actual charging time depends on the charging environment, watch settings, and other factors.

● Power Saving

Leaving the watch in a dark location for about one hour between the hours of 10 p.m. and 5:50 a.m. will cause the second hand to stop, and the watch to enter Level 1 power saving. If the watch is left in this condition for six or seven days, all hands will stop at 12 o'clock and the watch will enter Level 2 power saving.

Level 1 :

Second hand stops to save power.

Level 2 :

The following operations are stopped to save power: all hand movement (excluding the day indicator), Bluetooth connection, and alarm alerts.

Note

- Note that the watch also may enter the power saving state if its face is blocked from light by your sleeve while you are wearing it.
- The watch will enter power saving from the Calendar Mode only.

Recovering from Power Saving Operation

Use one of the operations below to exit power saving.

- Press any button.
- Pull out the crown.
- Move the watch to a bright location.

Viewing the Face in the Dark

The watch has an LED light that you can use to illuminate the display for about 1.5 seconds for viewing in the dark. When turned on, illumination becomes gradually brighter and then gradually dimmer.

Illumination can be used in the Calendar Mode and Alarm Mode.

● Turning On Illumination

Press (A) to illuminate the face of the watch.

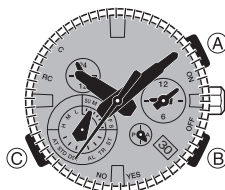

- Illumination turns off automatically if an alarm starts to sound.
- Illumination is disabled while the hands are moving at high speed.

Useful Features

Pairing the watch with your phone makes a number of the watch's features easier to use.

Auto time correction

[Auto Time Correction](#)

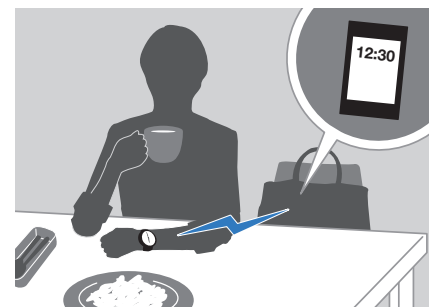

Selection of More Than 300 World Time cities

[Configuring World Time Settings](#)

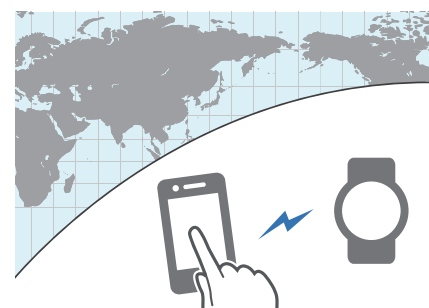

In addition, a number of other watch settings can be configured using your phone.

To transfer data to a watch and to configure settings, you first need to pair the watch with your phone.

[Getting Ready](#)

- Your phone needs to have the "CASIO WATCHES" phone app installed to pair with the watch.

Linking with a Phone

While there is a Bluetooth connection between the watch and phone (Mobile Link), the watch's current time setting is corrected automatically. You can also change the watch's other settings.

Note

- This function is available only while the CASIO WATCHES phone app is running on the phone.
- This section describes watch and phone operations.
 - 🕒 : Watch operation
 - 📱 : Phone operation

Getting Ready

To use your watch in combination with a phone, you first need to pair them. Perform the steps below to pair the watch with a phone.

- ① Install the app on your phone.
- ② Configure Bluetooth settings.
- ③ Pair the watch with a phone.

● ① Install the required app on your phone.

In Google Play or the App Store, search for the "CASIO WATCHES" phone app and install it on your phone.

● ② Configure Bluetooth settings.

Enable the phone's Bluetooth.

Note

- For details about setting procedures, see your phone documentation.

● ③ Pair the watch with a phone.

1. Move the phone to be paired with close to (within one meter of) the watch.
2. 📱 Tap the "CASIO WATCHES" icon.
3. 📱 Tap the + of the "My Watch" tab.
4. 📱 Perform the operation shown on the phone screen to register the watch to the CASIO WATCHES phone app.
5. 🕒 Hold down (C) for at least 2.5 seconds until the second hand points to [C].

When a connection is established between the watch and phone, the second hand moves to [C].

At this time the time settings of your phone and watch are synced with each other.

- If pairing fails, the watch returns to the state it was in before starting this procedure. Perform the pairing procedure again from the beginning.

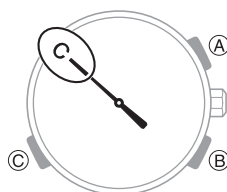

This completes the pairing operation. Once paired, the smartphone and watch automatically connect to synchronize the watch's time setting with that of the smartphone.

Note

- The first time you start up the CASIO WATCHES phone app, a message will appear on your phone asking if you want to enable location information acquisition. Configure settings to allow background use of location information.

Auto Time Correction

Your watch connects with a phone at preset times each day and corrects its time settings automatically.

● Using This Function

Your watch adjusts its time setting four times a day according to a preset schedule. If you leave the watch in the Calendar Mode, it will perform the adjustment operation automatically as you go about your daily life (as shown in the illustration), without any operation required by you.

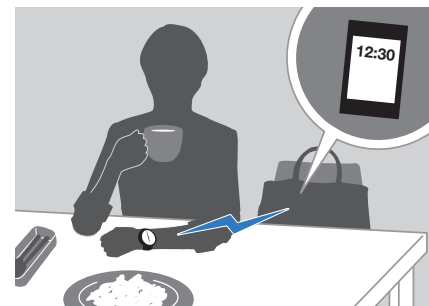

Important!

- Note that the watch will not perform auto time correction if it enters the Calendar Mode while any one of the conditions below exists.
 - Battery power is low.
 - Watch is in Level 2 power saving.
 - While the watch is too far away from its paired phone
 - While communication is not possible due to radio interference, etc.
 - While the phone is updating its system
 - While the CASIO WATCHES phone app is not running on the phone

Note

- If the watch does not indicate the correct time even if it is able to connect with a phone, correct the hand and date indicator positions.
[Correcting Hand and Day Indicator Alignment](#)
- If there is a World Time City specified with the CASIO WATCHES phone app, its time will also be synchronized automatically.
- The watch connects with the phone and performs auto time correction at around 12:30 a.m., 6:30 a.m., 12:30 p.m. and 6:30 p.m. The connection is automatically terminated after auto time correction is complete.

● Triggering Immediate Time Correction

The watch's time setting is corrected automatically whenever you establish a connection between the watch and a phone. Whenever you want to trigger immediate time correction, perform the procedure below to connect with a phone.

1. Move the phone close to (within one meter of) the watch.
2. Hold down (B) for at least 0.5 seconds until the second hand points to [C]. Release the button as soon as the second hand points to [C].

When the watch connects with a phone, the second hand performs one revolution and then points to [C] again. Next, the watch's time setting is adjusted to that of the phone.

- At this time your current location is recorded by your phone.
- The connection is terminated automatically after time correction is complete.



Configuring World Time Settings

Specifying a World Time City with the CASIO WATCHES phone app causes the watch's World Time City to change accordingly. The standard time/summer time setting of the World Time will be corrected automatically without any watch operation required by you.



Note

- The CASIO WATCHES phone app World Time lets you select from among approximately 300 cities as the World Time City.

● To select a World Time City

1. Tap the "CASIO WATCHES" icon.
2. Hold down (C) for at least 2.5 seconds. This establishes a connection between the watch and phone.

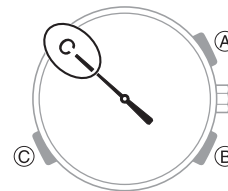

3. Perform the operation shown on the phone screen. The World Time setting will be reflected on the watch.

The dial small hour hand and small minute hands, and the small 24-hour hand indicate the current time in the selected city.

- You can determine whether a World Time is a.m. or p.m. by checking the position of the small 24-hour hand.

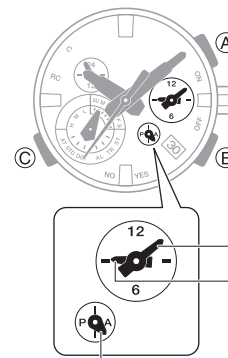

World Time hour (24-hour)

World Time hour and minute

● Configuring the Summer Time Setting

1. Tap the "CASIO WATCHES" icon.
2. Hold down (C) for at least 2.5 seconds.
This establishes a connection between the watch and phone.

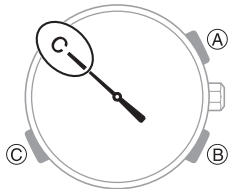

3. Perform the operation shown on the phone screen to select a summer time setting.
 - "Auto"
The watch switches between standard time and summer time automatically.
 - "OFF"
The watch always indicates standard time.
 - "ON"
The watch always indicates summer time.

Note

- While the summer time setting is "Auto", the watch switches between standard time and summer time automatically. You do not need to switch between standard time and summer time manually. Even if you are in an area that does not observe summer time, you can leave the watch's summer time setting as "Auto".
- Changing the time setting manually with a watch operation will cancel auto standard time/summer time switching.
- The CASIO WATCHES phone app screen shows information about summer time periods.

● Swapping Your World Time and Home Time

1. Tap the "CASIO WATCHES" icon.
2. Hold down (C) for at least 2.5 seconds.
This establishes a connection between the watch and phone.



3. Perform the operation shown on the phone screen to swap your Home Time with your World Time.
For example, if your Home City is Tokyo and the World Time City is New York, they will be swapped as shown below.

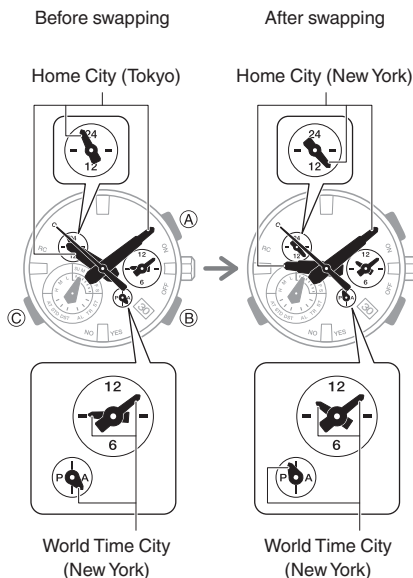

Note

- Auto time correction does not work for 24 hours after swapping the Home Time and World Time.

Setting the Alarm

1. Tap the "CASIO WATCHES" icon.
2. Hold down (C) for at least 2.5 seconds.
This establishes a connection between the watch and phone.

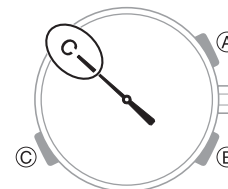

3. Perform the operation shown on the phone screen to configure alarm time settings.

Configuring Timer Settings

1. Tap the "CASIO WATCHES" icon.
2. Hold down (C) for at least 2.5 seconds.
This establishes a connection between the watch and phone.

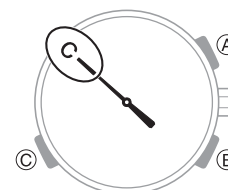

3. Perform the operation shown on the phone screen to configure the timer time setting.

Correcting Hand and Day Indicator Alignment

If the hands and/or day indicator are out of alignment even though auto time correction is being performed, you can use the CASIO WATCHES phone app to adjust them.

1. Tap the "CASIO WATCHES" icon.
2. Hold down (C) for at least 2.5 seconds. This establishes a connection between the watch and phone.

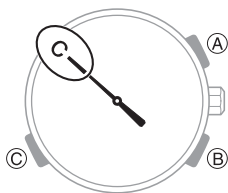

3. Perform the operation shown on the phone screen to correct hand and day indicator alignment.

Phone Finder

You can use phone finder to trigger a tone on the phone to make it easy to find. The tone is forced to sound even if the phone is in vibrate mode.

Important!

- Phone finder will not sound the tone unless the CASIO WATCHES phone app is running on the phone.
- Do not use this function in areas where phone call tones are restricted.
- The tone sounds at a high volume. Do not use this function when listening to phone output over earphones.

1. If the watch is connected with a phone, press any button to terminate the connection.

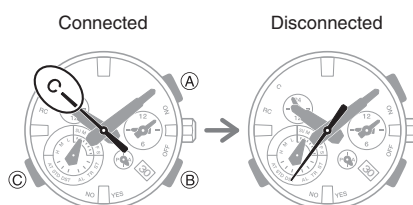

2. Hold down (B) for at least 3.5 seconds until the second hand points to [C]. A connection will be established between the watch and phone, and then the phone's ringtone will sound.

- It takes a few seconds before the phone tone sounds.

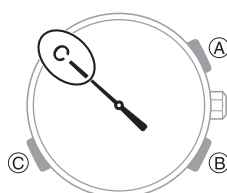

3. Press any button to stop the tone.
 - You can press any watch button to stop the phone tone, but only during the first 30 seconds after it starts to sound.

Configuring Watch Settings

After establishing a connection between the watch and a phone, you can use the CASIO WATCHES phone app to configure watch settings and to view information acquired by the watch.

1. Tap the "CASIO WATCHES" icon.
2. Hold down (C) for at least 2.5 seconds. This establishes a connection between the watch and phone.

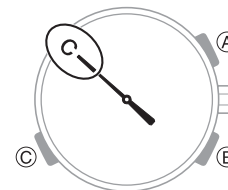

3. Select the setting you want to change and then perform the operation shown on the phone screen.

Changing the Home City Summer Time Setting

1. Tap the "CASIO WATCHES" icon.
2. Hold down (C) for at least 2.5 seconds. This establishes a connection between the watch and phone.

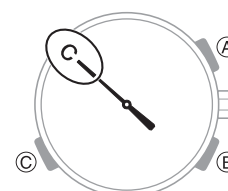

3. Perform the operation shown on the phone screen to change your Home City summer time setting.

Checking the Watch Charge Level

Use the procedure below to check the current charge level with the CASIO WATCHES phone app.

1. Tap the “CASIO WATCHES” icon.
2. Hold down (C) for at least 2.5 seconds.
This establishes a connection between the watch and phone.

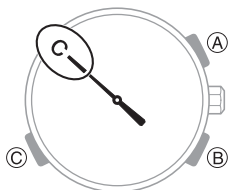

3. Use the CASIO WATCHES phone app to check the charge level.

Recording Your Current Location (TIME&PLACE)

While traveling or otherwise on the go, you can use the procedure below to record your current location, along with the time and date, on your phone. Recorded location information can be viewed on the CASIO WATCHES phone app map.

● Recording Your Current Location

1. Enter the Calendar Mode.
[Navigating Between Modes](#)
2. Hold down (B) for at least 0.5 seconds until the second hand points to [C]. Release the button as soon as the second hand points to [C].

This records, in phone memory, the latitude and longitude of the location you are in when you press (C), along with the date and time of the recording.

- When location recording is successful, the second hand performs one revolution and then points to [C] again. Next, watch syncs its time setting with your phone.

● Viewing a Recorded Location on a Map

1. Tap the “CASIO WATCHES” icon.
2. Perform the operation shown on the phone screen to view recorded location information.

Note

- You can use the CASIO WATCHES phone app to delete recorded location information.

Connection

Connecting with a Phone

Your watch can connect with a phone that is paired with it.

- If the watch is not paired with the phone you want to connect with, refer to the information below and pair them.

[Pair the watch with a phone.](#)

● Connecting with a Phone

1. Move the phone close to (within one meter of) the watch.
2. Hold down (C) for at least 2.5 seconds.
This establishes a connection between the watch and phone.

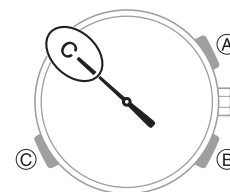

Important!

- If you have problems establishing a connection, it could mean that the CASIO WATCHES phone app is not running on your phone. On your phone's home screen, tap the “CASIO WATCHES” icon. After the app starts up, hold down the watch's (C) button for at least 2.5 seconds.

Note

- The connection is terminated if you do not perform any operation on the watch or phone for a fixed amount of time. To specify the connection limit time, perform the following operation with the CASIO WATCHES phone app: “Watch settings” → “Connection time with the app”. Next, select a setting of 3 minutes, 5 minutes, or 10 minutes.

Disconnecting from Your Phone

Pressing any button terminates the Bluetooth connection and returns the second hand to its normal operation.

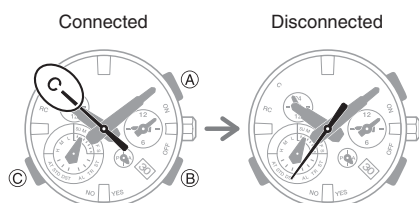

Using the Watch in a Medical Facility or Aircraft

Whenever you are in a hospital, on an aircraft, or in any other location where auto time calibration signal receive or connection with a phone may cause problems, you can perform the procedure below to disable auto time correction. To re-enable auto time correction, perform the same operation again.

1. Tap the "CASIO WATCHES" icon.
2. Hold down (C) for at least 2.5 seconds. This establishes a connection between the watch and phone.

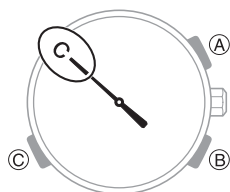

3. Perform the operation shown on the phone screen to enable or disable auto time correction.

Unpairing

Unpairing the watch from a phone requires both the CASIO WATCHES phone app and watch operations.

Deleting Pairing Information from the CASIO WATCHES phone app

1. If the watch is connected with a phone, press any button to terminate the connection.

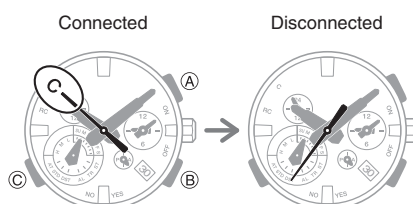

2. Tap the "CASIO WATCHES" icon.
3. Perform the operation shown on the phone screen to unpair.

Deleting Pairing Information from the Watch

1. Pull out the crown to the second click.
2. Hold down (B) for at least 10 seconds. This deletes the pairing information. The second hand will point to [C].

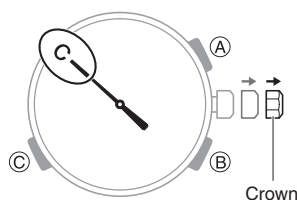

3. Push the crown back in.

If you purchase another phone

You need to perform the pairing operation whenever you want to establish a Bluetooth connection with a phone for the first time.

- ① [Deleting Pairing Information from the Watch](#)
- ② [Pair the watch with a phone.](#)

Time Adjustment

Your watch can obtain date and time information by connecting with a phone and by receiving time signals, which it uses to adjust its settings.

Important!

- Disable auto time correction whenever you are inside an aircraft or in any other area where radio wave reception is prohibited or restricted.
 - ① [Using the CASIO WATCHES Phone App to Configure Settings](#)
 - ② [Using Watch Operations to Configure Settings](#)

Referring to the information below, configure the time setting in accordance with the method that suits your own lifestyle.

Do you use a phone?

Time correction by connecting with your phone is recommended.

[Auto Time Correction](#)



Can you receive a time signal in your area?

If you are able to receive a time signal, time settings can be adjusted in accordance with a received signal.

[Time Signal Reception Ranges](#)

[Setting a Home City](#)

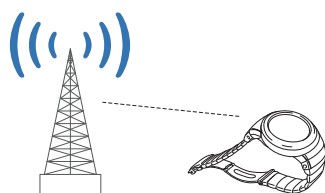

Other than the above.

If you are unable to connect with a phone and are unable to receive a time signal, you can perform watch button operations to adjust its time setting.

[Using Watch Operations to Correct the Time Setting](#)



Time Adjustment Using a Time Signal

Overview

The watch's time and day settings can be configured in accordance with a received time calibration signal.

Important!

- In order to make it possible for the current time setting to be adjusted correctly based on time calibration signal reception, you need to specify the time zone where you are using the watch.
- If the watch was unable to connect with a phone even once for time correction during the previous day while connection with a phone is being used, it will automatically try to receive a time calibration signal.
- Disable auto time correction whenever you are inside an aircraft or in any other area where radio wave reception is prohibited or restricted.
 - [Using the CASIO WATCHES Phone App to Configure Settings](#)
 - [Using Watch Operations to Configure Settings](#)

Note

- Areas where time calibration signal reception is supported are limited. When the watch is in an area where time calibration signal reception is not possible, connect with a phone to adjust time and day settings.
 - [Time Signal Reception Ranges](#)
- If the watch does not indicate the correct time even after it receives a time calibration signal, correct the hand and day indicator positions.
 - [Using CASIO WATCHES to Adjust Alignment](#)
 - [Using Watch Operations to Correct Hand Positions](#)

Appropriate Signal Reception Location

A time calibration signal can be received while the watch is near a window.

- Position the watch so its 12 o'clock side is facing the window.
- Keep metal objects away from the watch.
- Do not move the watch.
- Do not perform any operation on the watch.

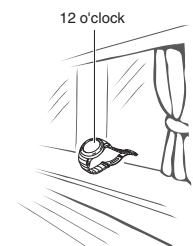

Note

- You may experience time calibration signal reception problems in the areas described below.
 - Among or near buildings
 - While riding in a vehicle
 - Near household appliances, office machines, mobile phones, etc.
 - On a construction site, in an airport, or any other location where radio wave interference occurs
 - Near high-voltage lines
 - In mountainous areas or behind a mountain

Time Signal Reception Ranges

● Japan (JJY)

The Japan time signal radio stations are located on Mt. Otakadoya in Fukushima and Mt. Hagane in Fukuoka/Saga.

The reception range of the Japanese time signals is approximately 1,000 km from each transmission station.

● China (BPC)

The China time signal radio station is located in Shangqiu, Henan Province, China.

The reception range of the Chinese time signal is approximately 1,500 km from the transmission station.

● United States (WWVB)

The United States time signal radio station is located in Fort Collins, Colorado.

The reception range of the U.S. time signal is approximately 3,000 km from the transmission station.

● U.K. (MSF)/Germany (DCF77)

The U.K. time signal radio station is located in Anthorn, Cumbria.

The German time signal radio station is located in Mainflingen, southeast of Frankfurt. The reception range of the U.K. and German time signals is approximately 1,500 km from each transmission station.

Note

- Even if you are within the normal reception range of a time calibration signal, reception may be made impossible by the following factors: geographic contours, weather, the season, the time of day, wireless noise.

Auto Time Calibration Signal Receive

An automatic time calibration signal receive operation is performed and the time and day settings are corrected between midnight and 5:00 a.m. Once a signal receive operation is successful, no more auto receive operations are performed that day.

Getting Ready

Enter the Calendar Mode.

[Navigating Between Modes](#)

Place the watch near a window or some other location appropriate for signal reception.

- The second hand points to [RC] while the receive operation is in progress.
- When the receive operation is successful, the time and day settings will be adjusted automatically.

Note

- Reception takes anywhere from about two minutes to about 10 minutes. It can take as long as 20 minutes.
- If the watch connects with a phone and adjusts its time setting, the watch will not perform auto receive of a time calibration signal for the rest of that day or the next day.

Manual Time Calibration Signal Receive

1. Place the watch near a window or some other location appropriate for time signal reception.
2. Enter the Calendar Mode.
 [Navigating Between Modes](#)
3. Hold down (B) for at least 0.5 seconds until the second hand points to [RC].

This indicates that the receive operation has started. After the receive operation is complete, the watch's time and day settings will be corrected accordingly.

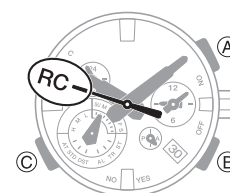

Note

- The receive operation takes anywhere from about two minutes to about 10 minutes. It can take as long as 20 minutes.
- Time calibration signal reception is better at night than during the day.
- A time calibration signal cannot be received while the watch is paired with a phone.

Signal Reception Precautions

- When the watch is unable to correct its time in accordance with a calibration signal for some reason, average timekeeping accuracy is within ± 15 seconds per month.
- Note that an internal decoding process the watch performs after it receives a signal may cause the time setting to be slightly off (by less than one second).
- Time calibration signal reception is not possible under the conditions described below.
 - While battery power is low
 - In any mode besides the Calendar Mode
 - At Power Saving Level 2
 - While the crown is pulled out
 - While the Home City setting is a time zone where time signal reception is not possible
 - While the watch is outside the time signal reception range
 - While the watch is paired with a phone
- To perform a manual time calibration signal receive operation, make sure the watch is not paired with a phone. If it is, delete the watch's pairing information before performing the manual receive operation.

[Unpairing](#)
- When the receive operation is successful, the time and/or day settings will be corrected automatically. Summer time will not be applied correctly in the case described below.
 - When the summer time start date and time, end date and time, or other rules are changed by authorities
- If your watch is connected with a phone, settings must be configured so CASIO WATCHES can acquire location information. Even if you are in an area that is within the reception range of a time signal, reception will not be performed if settings are configured in a way that makes signal reception impossible.

Using Watch Operations to Correct the Time Setting

If your watch cannot connect with a phone for some reason, you can use watch operations to adjust date and time settings.

Setting a Home City

Use the procedure in this section to select a city (time zone) to use as your Home City.

Important!

- If you do not specify the city (time zone) where you are using the watch, the current time setting will not be correct after it is adjusted based on a time calibration signal.

1. Pull out the crown to the second click.

The second hand will move to the city code of the currently selected Home City.

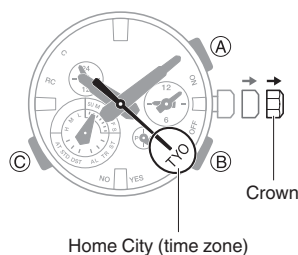

2. Rotate the crown to change the Home City.
 - You can also select a time zone whose name is not indicated on the face of the watch.
 - For details about time zones, refer to the information below.

[City Table](#)
3. Push the crown back in.

Adjusting the Time and Day Setting

1. Pull out the crown to the second click.

The second hand will move to the city code of the currently selected Home City.

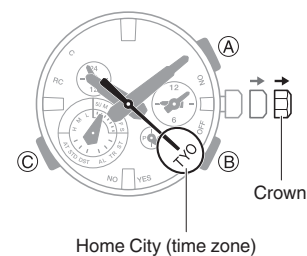

2. Hold down (C) for at least one second.

This causes the second hand to move to 12 o'clock, and enables the minute setting operation.
3. Rotate the crown to change the minute setting.
4. Press (C).

This enables the hour setting operation.
5. Rotate the crown to change the hour setting.
6. Press (C).

This enables the year ten's digit setting operation.
7. Rotate the crown to move the second hand to the desired setting for the year ten's digit.

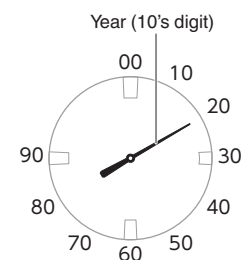

8. Press (C).

This enables the year one's digit setting operation.

- Rotate the crown to move the second hand to the desired setting for the year one's digit.

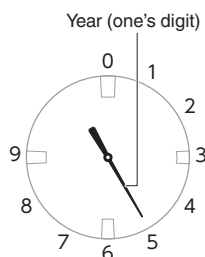

- Press (C).
This enables the month setting operation.

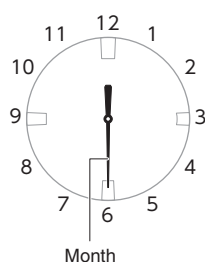

- Rotate the crown to change the month.
- Press (C).
The mode hand will move slightly, indicating that the day setting operation is enabled.



- Changing the day setting will cause the mode hand to rotate repeatedly.
[Hand and Day Indicator Movement](#)

- Rotate the crown to change the day.
 - To return to the minute setting operation, press (C).
- On a time signal at the top of a minute, push the crown back in.

Configuring the Summer Time Setting (Home City)

If you are in an area that observes summer time, you can also configure a summer time setting.

Note

- The initial factory default summer time setting for all cities is [AT (AUTO)]. In many cases, the [AT (AUTO)] setting lets you use the watch without switching between summer time and standard time.
- When performing a manual operation to select a time zone for which there is no city name displayed, use [STD] or [DST] for the summer time setting.

- Pull out the crown to the second click.
The second hand will move to the city code of the currently selected Home City.

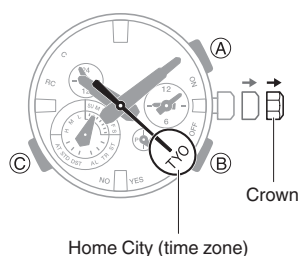

- Hold down (A) for at least one second.
Each time you hold down (A) for at least one second, the summer time setting will cycle to the next available option.

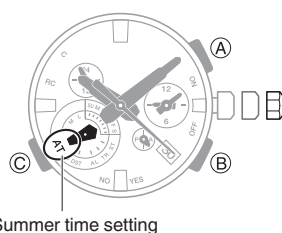

- [AT (AUTO)]
The watch switches between standard time and summer time automatically.
 - [STD]
The watch always indicates standard time.
 - [DST]
The watch always indicates summer time.
- Push the crown back in.

Checking the Last Time Correction Result

- Enter the Calendar Mode.
[Navigating Between Modes](#)
- Press (B).

The second hand will indicate the last time correction operation result. The watch hands will return to indicating the current time if you do not perform any operation for nine or ten seconds.

[Y (YES)]: Last time correction operation successful.

[N (NO)]: Last time correction operation failed.

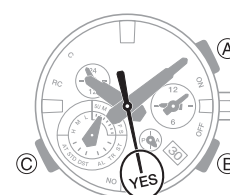

Note

- Even if there was a successful time calibration signal receive operation or connection with a phone, the second hand will point to [N (NO)] if you subsequently adjusted the time and/or date setting manually.

Using the Watch in a Medical Facility or Aircraft

Whenever you are in a hospital, on an aircraft, or in any other location where auto time calibration signal receive or connection with a phone may cause problems, you can perform the procedure below to disable auto time correction. To re-enable auto time correction, perform the same operation again.

1. Enter the Calendar Mode.
[🔗 Navigating Between Modes](#)

2. Press (B).
 The second hand will indicate the last receive result for nine or ten seconds.

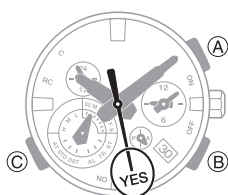

3. Within 10 seconds after pressing (B) above, pull out the crown to the first click.
 - If more than 10 seconds elapse before you pull out the crown after you perform the operation in step 2, the second hand will return to indicating seconds. If this happens, perform step 2 again.

4. Rotate the crown to disable auto time correction.
 [Y(YES)]: Auto time correction enabled
 [N(NO)]: Auto time correction disabled

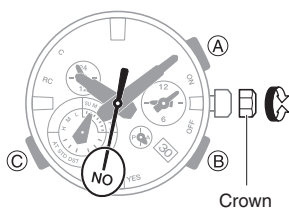

5. Push the crown back in.

Note

- If the watch is paired with a phone, you can use the CASIO WATCHES phone app to disable auto time correction.
[🔗 Using the CASIO WATCHES Phone App to Disable Auto Time Correction](#)

World Time

World Time lets you look up the current time in any one of 27 cities and 38 time zones around the globe.



Using the CASIO WATCHES Phone App to Configure World Time City Settings

If the watch is paired with a phone, you can also use the CASIO WATCHES phone app to set the World Time city.

1. [🔗 Configuring World Time Settings](#)

Note

- World Time cities that can be selected only by using the CASIO WATCHES phone app cannot be selected using watch operations.

Specifying a World Time City

Use the procedure below to specify the city (time zone) whose time you want to view.

1. Enter the Calendar Mode.
[🔗 Navigating Between Modes](#)
2. Pull out the crown to the first click.
 The second hand will point to the currently selected World Time City.

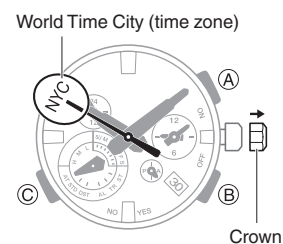

3. Rotate the crown to change the World Time City (time zone).

The World Time hour and minute hands indicate the current time in the selected time zone.

- You can also select a time zone whose name is not indicated on the face of the watch.
- For details about time zones, refer to the information below.
[🔗 City Table](#)

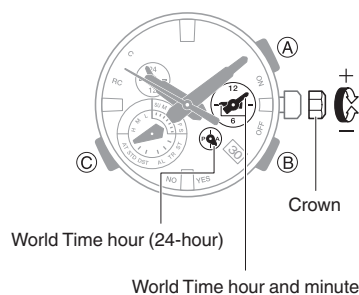

4. Push the crown back in.

Configuring the Summer Time Setting (World Time)

If you are in an area that observes summer time, you can also configure a summer time setting.

Note

- The initial factory default summer time setting for all cities is [AT (AUTO)]. In many cases, the [AT (AUTO)] setting lets you use the watch without switching between summer time and standard time.
- When performing a manual operation to select a time zone for which there is no city name displayed, use [STD] or [DST] for the summer time setting.
- While [UTC] is selected as the city, you will not be able to change or check the summer time setting.

1. Enter the Calendar Mode.

[🔗 Navigating Between Modes](#)

2. Pull out the crown to the first click.

The second hand will point to the currently selected World Time City (time zone).

3. Hold down (A) for at least one second.

Each time you hold down (A) for at least one second, the summer time setting will cycle to the next available option.

- [AT (AUTO)]
The watch switches between standard time and summer time automatically.
- [STD]
The watch always indicates standard time.
- [DST]
The watch always indicates summer time.

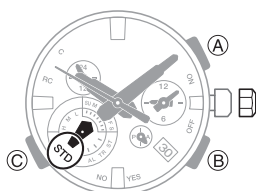

4. Push the crown back in.

Swapping Your Home City Time and World Time

In the Calendar Mode, you can swap your Home City time with your World Time by holding down (A) for at least three seconds.

Example: To swap your Home City “TYO” (Tokyo) with your World Time City “NYC” (New York)

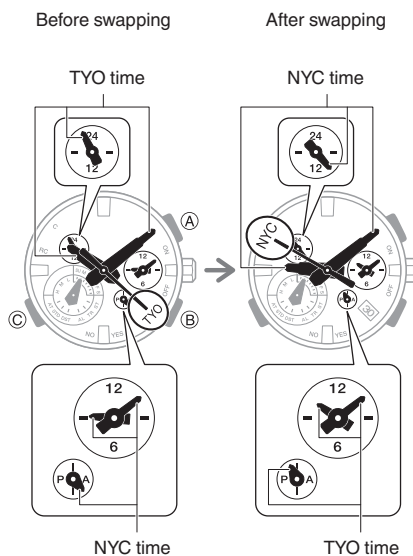

- If a swapping operation causes a change in the day indicator setting, the mode hand will rotate repeatedly.

[🔗 Hand and Day Indicator Movement](#)

Note

- This function comes in handy when you need to move to another time zone. For details about how to use it, go to the section below.

[🔗 Moving Between Time Zones](#)

Moving Between Time Zones

Use the procedure below to easily change day and time settings of the watch to a destination location.

● Before Boarding

1. Configure the World Time to the current time at your destination.

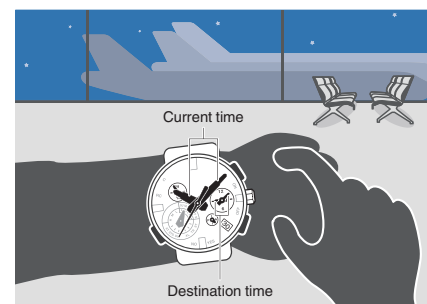

[🔗 Using the CASIO WATCHES Phone App to Configure Settings](#)

[🔗 Using Watch Operations to Configure Settings](#)

2. Disable auto time correction.

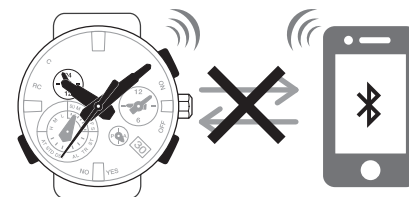

[🔗 Using the CASIO WATCHES Phone App to Configure Settings](#)

[🔗 Using Watch Operations to Configure Settings](#)

● After Arriving

1. Swap the origin time zone time with the destination time zone time.

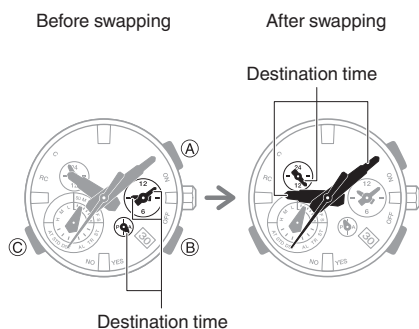

[Using CASIO WATCHES to Configure Settings](#)

[Using Watch Operations to Configure Settings](#)

2. Enable auto time correction.

[Using the CASIO WATCHES Phone App to Configure Settings](#)

[Using Watch Operations to Configure Settings](#)

3. Correct the time setting.

[Triggering Immediate Time Correction](#)

Alarm

The watch will beep when the alarm time is reached.

- The beeper is muted in the cases described below.

- When battery power is low
- When the watch is at Level 2 power saving

[Power Saving](#)

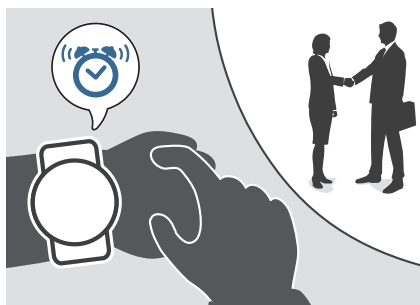

Using the CASIO WATCHES Phone App to Configure Alarm Settings

If the watch is paired with a phone, you can also use the CASIO WATCHES phone app to set alarms.

[Setting the Alarm](#)

Configuring Alarm Settings

1. Enter the Alarm Mode.
[Navigating Between Modes](#)
2. Pull out the crown to the first click.
This turns on the alarm.
3. Rotate the crown to change the alarm time setting.

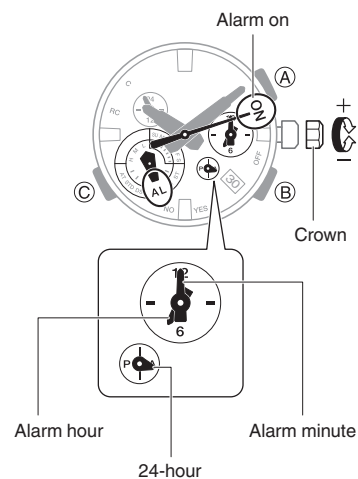

4. Push the crown back in.

Note

- A beeper sounds for 10 seconds when an alarm time is reached.
- The watch will automatically return from the Alarm Mode to the Calendar Mode if you do not perform any operation for about two or three minutes.

● To stop the alarm

To stop the alarm after it starts to sound when an alarm time is reached, press any button.

Turning Off the Alarm

To stop the alarm from sounding, perform the steps below to turn it off.

- To have the alarm sound again, turn it on.

1. Enter the Alarm Mode.

[Navigating Between Modes](#)

2. Press (B) to move the second hand to OFF.

- Each press of (B) toggles between on and off.

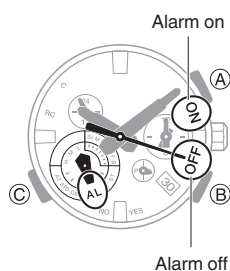

Stopwatch

The stopwatch measures elapsed time in units of one second up to 23 hours, 59 minutes, 59 seconds (24 hours).



Timer

The timer counts down from a start time specified by you. A beeper sounds when the end of the countdown is reached.

- The beeper is muted when battery power is low.



Measuring Elapsed Time

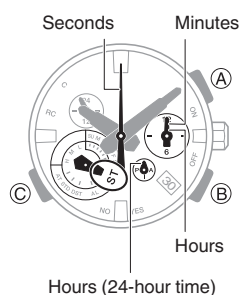

1. Enter the Stopwatch Mode.

[Navigating Between Modes](#)

2. Use the operations below to measure elapsed time.

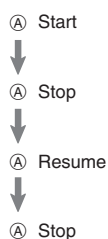

3. Press (B) to reset the stopwatch to all zeros.

Note

- The (C) button operations below can be performed while a stopwatch elapsed time measurement operation is in progress.
 - Connecting with a Paired Phone to Correct the Watch's Time
 - Pairing or Re-pairing the Watch with a Phone

Using the CASIO WATCHES Phone App to Configure Timer Settings

If the watch is paired with a phone, you can also use the CASIO WATCHES phone app to set the timer start time.

[Configuring Timer Settings](#)

Setting the Timer Start Time

- Enter the Timer Mode.
[Navigating Between Modes](#)
- Pull out the crown to the first click.
- Rotate the crown to change the countdown start time setting.
 - The countdown start time can be set in 1-minute units up to 24 hours.

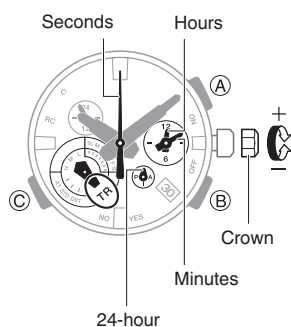

- Push the crown back in.

Note

- To specify a countdown start time of 24 hours, align the small hour and minute hands with 12 o'clock, so the small 24-hour hand aligns with 24.

Using the Timer

- Enter the Timer Mode.
[Navigating Between Modes](#)
- Press (A) to start the timer countdown.

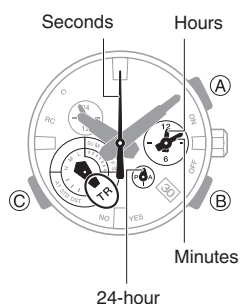

A beeper sounds for 10 seconds when the end of the countdown is reached.

- To pause an ongoing timer countdown, press (A). You can reset a paused timer countdown to its start time by pressing (B).
- Press any button to stop the tone.

Hand and Day Indicator Alignment

Strong magnetism or impact can cause the hands and/or the day indicator to go out of alignment. If this happens, correct hand and day indicator alignment.

- The watch performs alignment of the hour hand, minute hand, second hand, and 24-hour hand automatically.

Using the CASIO WATCHES Phone App to Adjust Hand and Day Indicator Alignment

If the watch is paired with a phone, you can also use the CASIO WATCHES phone app to correct hand and day indicator positions.

- [Correcting Hand and Day Indicator Alignment](#)

Adjusting Hand and Day Indicator Alignment

- Pull out the crown to the second click.
- Hold down (B) for at least five seconds until the second hand points to 12 o'clock. Release the button when the second hand reaches 12 o'clock.

This will start auto alignment of the hour hand, minute hand, second hand, and 24-hour hand.

- After auto alignment is complete, the hands should be in the positions shown below.

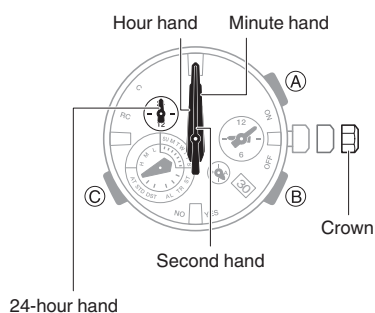

- Press (C).

Confirm that the small hour and minute hands, and the small 24-hour hand are all stopped at 12 o'clock.

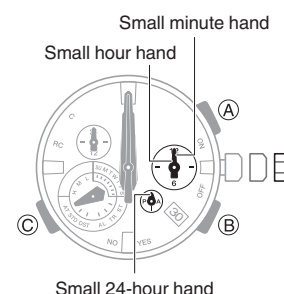

- If the small hour and minute hands, and the small 24-hour hand are not at 12 o'clock, rotate the crown to align them with 12 o'clock.

- Press (C).

Confirm that the mode hand is stopped at 12 o'clock, and check if the day is indicated properly.

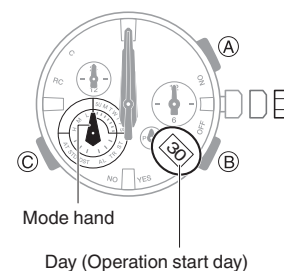

- If the mode hand and/or the day indicator is out of alignment, rotate the crown to move the mode hand to 12 o'clock and the day to the center of the indicator window.

- The movement range of the mode hand and day indicator is limited when you rotate the crown. The maximum left-right movement of the mode hand is 180 degrees in either direction. The day indicator moves only slightly.
- After the mode hand and day indicator are in the positions you want, advance to step 9 of this procedure. If you are unable to make the adjustments you want, go to step 7.

7. Press (C).

Confirm that the day indicator shows "1".

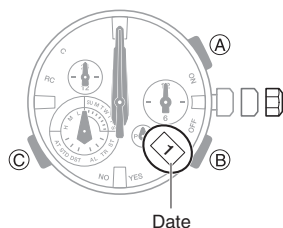

- Changing the date setting will cause the mode hand to rotate repeatedly. In some cases, the mode hand may continue to rotate for about 5 minutes.

Hand and Day Indicator Movement

8. If "1" is not shown for the day, rotate the crown until "1" is shown for the day.

- The mode hand moves in conjunction with crown rotation. Move the mode hand to 12 o'clock.

9. Push the crown back in.

Note

- Leaving the crown pulled out for more than approximately 30 minutes without performing any operation will automatically cause the adjustment operation to become disabled. If this happens, push the crown back in to its normal position and then pull it out again to restart the procedure from the beginning. Pushing the crown in to its normal position part way through the alignment procedure will cause the hands to return to their normal position. Any alignment you performed up to that point will be applied.

Other Settings

This section explains other watch settings you can configure.

Resetting Watch Settings

This section explains how to return the watch settings below to their initial factory defaults.

- Watch Settings
- Stopwatch
- Timer
- Alarm

1. Pull out the crown to the second click.
2. Hold down (C) for at least five seconds until the second hand points to 12 o'clock twice.

Resetting watch settings causes the second hand to move to 12 o'clock.

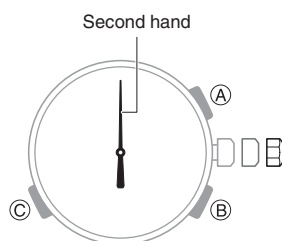

3. Push the crown back in.

Specifications

Accuracy at normal temperature :

±15 seconds per month when time correction by time calibration signal reception or by communication with a phone is not possible.

Timekeeping :

Hour, minute (10-second hand movement), second, day (Full Auto Calendar 2000 to 2099), day of the week

Signal Receive Functions :

Auto receive, manual receive
Auto transmitter selection (for JJY, MSF/DCF77)

Receivable Call Signs

JJY (40kHz/60kHz), BPC (68.5kHz),
WWVB (60kHz), MSF (60kHz), DCF77 (77.5kHz)

Automatic and manual switching between standard time and summer time.

Auto time correction enable/disable switching

World Time :

Current time in 38 time zones (including 27 world cities)* and Coordinated Universal Time (UTC) time display, summer time auto switching

* Subject to updates by connection between the watch and a phone.

Stopwatch :

Measuring unit: 1 second
Measuring capacity: 23:59'59" (24 hours)
Measuring functions: Elapsed time

Alarm :

Daily alarm
Setting units: Hours, minutes
Beeper: 10 seconds

Timer :

Setting unit: 1 minute
Countdown range: 24 hours
Measuring unit: 1 second
10-second beeper when the end of the countdown is reached

Mobile Link :

- Auto Time Correction
 - Time setting corrected automatically at preset time
- One-touch Time Correction
 - Manual connection and time correction
- Phone finder
 - Watch operation sounds the alert sound of the phone.
- Home Time swapping
- Auto Summer Time Switching
 - Automatic switching between standard time and summer time
- Timer Settings
- Alarm Settings
- Hand alignment correction
- TIME&PLACE
 - Auto time correction enable/disable switching
- Data Communication Specifications
 - Bluetooth®
 - Frequency Band: 2400MHz to 2480MHz
 - Maximum Transmission: 0 dBm (1 mW)
 - Communication range: Up to 2 meters (depends on environment)

Other :

- High-luminosity LED light (Super Illumination, afterglow)
- Auto hand alignment correction
- Power Saving
- Battery Indicator
- Low Battery Alert

Power Supply :

- Solar panel and one rechargeable battery (Type: CTL920)
- Battery nominal voltage: 2.3V

Approximate Battery Life :

- Approximately 5 months
- Conditions
 - Auto time correction using a smartphone: 4 times/day
 - Alarm: Once (10 seconds)/day
 - Illumination: Once (1.5 seconds)/day
 - Power Saving: 6 hours/day

Specifications are subject to change without notice.

Other Information

This section provides non-operational information you also need to know. Refer to this information as required.

City Table

You can specify a time zone whose city code is not shown on the face by aligning the second hand with the applicable UTC offset.

City code	City name	Second Hand Position	Offset
UTC	Coordinated Universal Time	0	0
LON*	London	2	0
PAR*	Paris	4	+1
ATH*	Athens	6	+2
JED	Jeddah	8	+3
-	-	9	+3.5
DXB	Dubai	10	+4
-	-	11	+4.5
-	-	12	+5
DEL	Delhi	13	+5.5
-	-	14	+5.75
DAC	Dhaka	15	+6
-	-	16	+6.5
BKK	Bangkok	17	+7
BJS*	Beijing	19	+8
-	-	21	+8.75
TYO*	Tokyo	22	+9
-	-	23	+9.5
SYD	Sydney	24	+10
-	-	25	+10.5
NOU	Noumea	26	+11
WLG	Wellington	28	+12
-	-	29	+12.75
TBU	Nuku'alofa	30	+13
CXI	Kiritimati	32	+14
BAR	Baker Island	36	-12
PPG	Pago Pago	38	-11
HNL	Honolulu	40	-10
-	-	41	-9.5
ANC	Anchorage	42	-9
LAX*	Los Angeles	44	-8
DEN*	Denver	46	-7
CHI*	Chicago	48	-6
NYC*	New York	50	-5
YHZ*	Halifax	52	-4
-	-	53	-3.5
RIO	Rio de Janeiro	54	-3
FEN	Fernando de Noronha	56	-2
RAI	Praia	58	-1

* Time zones where time calibration signal reception is possible.

- The information in the above table is current as of July 2024.

Summer Time Table

When [AT (AUTO)] is selected for a city that observes summer time, switching between standard time and summer time will be performed automatically at the timing shown in the table below.

Note

- Summer time start and end dates for your current location may be different from those shown below. If this happens, you can have new summer time information for your Home City and World Time City sent to the watch by connecting the watch with a phone. If the watch is not connected with a phone, you can change the summer time setting manually.

City name	Summer Time Start	Summer Time End
London	01:00, last Sunday in March	02:00, last Sunday in October
Paris	02:00, last Sunday in March	03:00, last Sunday in October
Athens	03:00, last Sunday in March	04:00, last Sunday in October
Sydney	02:00, first Sunday in October	03:00, first Sunday in April
Wellington	02:00, last Sunday in September	03:00, first Sunday in April
Anchorage	02:00, second Sunday in March	02:00, first Sunday in November
Los Angeles	02:00, second Sunday in March	02:00, first Sunday in November
Denver	02:00, second Sunday in March	02:00, first Sunday in November
Chicago	02:00, second Sunday in March	02:00, first Sunday in November
New York	02:00, second Sunday in March	02:00, first Sunday in November
Halifax	02:00, second Sunday in March	02:00, first Sunday in November

- The information in the above table is current as of July 2024.

Supported Phones

For information about phones that can connect with the watch, visit the CASIO website.

https://world.casio.com/os_mobile/wat/

Copyrights and Registered Copyrights

- The Bluetooth® word mark and logos are registered trademarks owned by the Bluetooth SIG, Inc. and any use of such marks by CASIO Computer Co., Ltd. is under license.
- iPhone and App Store are trademarks of Apple Inc. in the United States and other countries.
- IOS is a trademark or registered trademark of Cisco Systems, Inc.
- Android and Google Play™ are trademarks or registered trademarks of Google LLC.
- Other company names and product names used herein are trademarks or registered trademarks of their respective companies.

Troubleshooting

Signal Reception (Time Calibration Signal)

Q1 The watch cannot perform a receive operation.

Is the watch's battery charged?

Signal reception is not possible while battery power is low. Keep the watch exposed to light until it recharges sufficiently.

↪ [Charging](#)

Is the watch in the Calendar Mode?

Time signal reception is performed only while the watch is in the Calendar Mode. Return to the Calendar Mode.

↪ [Navigating Between Modes](#)

Is auto time correction enabled?

Time signals cannot be received while auto time correction is disabled. Enable auto time correction.

↪ [Using the CASIO WATCHES Phone App to Configure Settings](#)

↪ [Using Watch Operations to Configure Settings](#)

Is your Home City setting correct for your location?

The watch will not indicate the correct time if the Home City setting is wrong. Change your Home City setting so it correctly reflects your location.

↪ [Setting a Home City](#)

After checking the above, the watch still cannot perform a receive operation.

Time calibration signal reception is not possible under the conditions described below.

- When watch is at Level 2 power saving
- When the crown is pulled out
- While the watch is paired with a phone

For information about unpairing, see "Unpairing".

If successful reception is not possible for some reason, you can adjust the time and day settings manually.

Q2 The signal receive operation always fails.

Is the watch in a location that is appropriate for signal reception?

Check your surroundings and move the watch to a location where signal reception is better.

↪ [Appropriate Signal Reception Location](#)

Did you avoid touching the watch while the receive operation was in progress?

Minimize movement of the watch and do not perform any watch operation while a receive operation is in progress.

Is the signal transmitter in your area transmitting a signal?

The transmitter of the time calibration may not be transmitting a signal. Try again later.

Q3 Signal reception should have been successful, but the watch's time and/or day is wrong.

Is the time zone where you are using the watch specified correctly?

Specify the time zone where you are using the watch.

↪ [Setting a Home City](#)

↪ [Specifying a World Time City](#)

Is the hand and/or day indicator alignment correct?

Adjust hand and/or day indicator alignment.

↪ [Hand and Day Indicator Alignment](#)

After checking the above, the time and/or day settings is still wrong.

Adjust time and day settings manually.

↪ [Using Watch Operations to Correct the Time Setting](#)

I can't pair the watch with a phone.

Q1 I've never been able to establish a (pairing) connection between the watch and phone.

Are you using a supported phone model?

Check if the phone model and its operating system are supported by the watch.

For information about supported phone models, visit the CASIO Website.

↪ https://world.casio.com/os_mobile/wat/

Did you install the CASIO WATCHES phone app on your phone?

The CASIO WATCHES phone app needs to be installed on your phone in order to connect with the watch.

↪ [Install the required app on your phone.](#)

Are your phone's Bluetooth settings configured correctly?

Configure the phone's Bluetooth settings. For details about setting procedures, see your phone documentation.

iPhone Users

- "Settings" → "Bluetooth" → On
- "Settings" → "Privacy" → "Bluetooth" → "CASIO WATCHES" → On

Android Users

- Enable Bluetooth.

Other than the above.

Some phones need to have BT Smart disabled to use the CASIO WATCHES phone app. For details about setting procedures, see your phone documentation.

On the Home Screen, tap: "Menu" → "Settings" → "Bluetooth" → "Menu" → "BT Smart settings" → "Disable".

I can't reconnect the watch and phone.

Q1 The watch will not re-connect with the phone after they are disconnected.

Is the CASIO WATCHES phone app running?

The watch cannot re-connect with your phone unless the CASIO WATCHES app is running on the phone. On your phone's Home Screen, tap the "CASIO WATCHES" icon. Next, on the watch, hold down (C) for at least 2.5 seconds.



Have you tried turning your phone off and then back on again?

Turn your phone off and back on, and then tap the "CASIO WATCHES" icon. Next, on the watch, hold down (C) for at least 2.5 seconds.

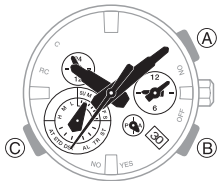

Is the watch's battery charged sufficiently?

Connection with a phone is not possible while the charge is low. Charge the watch and then connect with the phone.

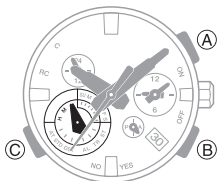

Q2 I can't connect while my phone is in the Airplane Mode.

Connection with the watch is not possible while your phone is in the Airplane Mode. After disabling the phone's Airplane Mode, go to the phone's Home Screen and tap the "CASIO WATCHES" icon. Next, on the watch, hold down (C) for at least 2.5 seconds.

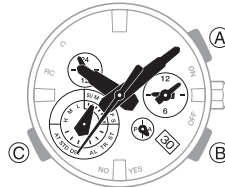

Q3 I can't establish a connection after disabling the auto time correction on the watch.

On the watch, enable auto time correction and then hold down (C) for at least 2.5 seconds.

- 🔗 [Using the CASIO WATCHES Phone App to Configure Settings](#)
- 🔗 [Using Watch Operations to Configure Settings](#)



Q4 I changed the phone's Bluetooth from enabled to disabled, and now I can't connect anymore.

On your phone, re-enable Bluetooth, and then go to the Home Screen and tap the "CASIO WATCHES" icon. Next, on the watch, hold down (C) for at least 2.5 seconds.



Q5 I can't connect after turning off the phone.

Turn your phone off and back on, and then tap the "CASIO WATCHES" icon. Next, on the watch, hold down (C) for at least 2.5 seconds.

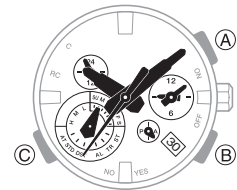

Phone-Watch Connection

Q1 I can't establish a connection between the phone and watch.

Have you tried turning your phone off and then back on again?

Turn your phone off and back on, and then tap the "CASIO WATCHES" icon. Next, on the watch, hold down (C) for at least 2.5 seconds.



Has the watch been re-paired with the phone?

After deleting the pairing information from the CASIO WATCHES phone app and your phone, re-pair the watch and phone.

- 🔗 [Deleting Pairing Information from the CASIO WATCHES phone app](#)
- 🔗 [③ Pair the watch with a phone.](#)

If you are unable to establish a connection...

After deleting pairing information from the watch, re-pair it with your phone.

- 🔗 [Deleting Pairing Information from the Watch](#)
- 🔗 [③ Pair the watch with a phone.](#)

Changing to a Different Phone Model

Q1 How do I connect my watch to a different phone?

Delete the pairing information from your watch and then pair it with the phone you want to connect with.

🔗 [If you purchase another phone](#)

Auto Time Correction by Bluetooth Connection (Time Correction)

Q1 When does the watch correct its time?

Your watch can connect with a paired phone to adjust its time setting. The watch will connect with the phone and perform auto time correction at around 12:30 a.m., 6:30 a.m., 12:30 p.m. and 6:30 p.m. Also, time signal auto-receive will be performed if there has been no auto time correction based on connection between the watch and phone for more than one day.

Q2 Auto time correction is performed, but the time setting is not correct.

Is auto time correction not being performed according to its normal schedule?

Note that auto time correction is not performed for 24 hours after swapping of the Home Time and World Time, or after the time setting is corrected manually on the watch. Auto time correction will resume 24 hours after either of the above operations is performed.

Is auto time correction enabled?

Auto time correction will not be performed at the scheduled times if it is not enabled. Establish a connection between the watch and phone, and then use the CASIO WATCHES phone app to enable auto time correction.

🔗 [Using the Watch in a Medical Facility or Aircraft](#)

Is the watch's battery charged sufficiently?

Connection with a phone is not possible while the charge is low. Charge the watch.



Q3 Time is not displayed correctly.

If your phone is unable to receive a signal because you are outside its service range or for some other reason, the watch may not be able to display the correct time. If this happens, connect the phone to its network and then correct the time setting.

Q4 Time signal reception is not performed while watch is connected with a phone.

The watch does not receive a time signal for time correction while it is connected with a phone. However, time signal auto-receive is performed if there has been no auto time correction based on connection between the watch and phone for more than one day.

World Time

Q1 The time for a World Time City is not correct.

The summer time start date and time, end date and time, or other rules were changed by authorities.

Alarm

Q1 The alarm does not sound.

Is the watch's battery charged?

Keep the watch exposed to light until it recharges sufficiently.

🔗 [Charging](#)

The crown is pulled out.

The alarm will not sound while the crown is pulled out. Push the crown back in to its normal position.

Is the alarm enabled?

Enable the alarm.

🔗 [Configuring Alarm Settings](#)

Hand Movement and Indications

Q1 I don't know what mode the watch is in.

You can determine the current mode by checking the mode hand position. You can use (C) to navigate between modes.

🔗 [Navigating Between Modes](#)



Q2 Why can't I perform any button operations while high-speed hand movement is in progress?

Except for the mode navigation button, button operation is disabled while high-speed hand movement is in progress after a watch setting is changed, etc. Wait until the hands stop moving before performing button operations.

Q3 The second hand is jumping at two-second intervals.

Battery power is low. Keep the watch exposed to light until it recharges sufficiently.

🔗 [Charging](#)

Q4 All hands are stopped at 12 o'clock and buttons do not work.

The battery is dead. Keep the watch exposed to light until it recharges sufficiently.

🔗 [Charging](#)

Q5 The hands suddenly start moving at high speed.

This is due to the reason (or one of the reasons) below, and does not indicate malfunction. Simply wait until normal hand movement resumes.

- The watch is recovering from a power saving state.
 - 🔗 [Power Saving](#)
- A time calibration signal is being received and the time setting is being adjusted.
 - 🔗 [Time Adjustment Using a Time Signal](#)
- Watch is connected with a phone to correct its time setting.
 - 🔗 [Auto Time Correction](#)

Q6 Hands are stopped and buttons do not work.

The watch is in the charge recovery mode. Wait until the recovery process is complete (for about 15 minutes). The watch will recover more quickly if you place it in a brightly lit location.

Q7 Why is the current time indicated by the watch is off by a certain amount of time (nine hours, three hours and 15 minutes, etc.)?

The city setting is not correct. Select the correct setting.

[Setting a Home City](#)

Q8 The current time indicated by the watch is off by one hour or 30 minutes.

The summer time setting is not correct. Select the correct setting.

[Configuring the Summer Time Setting \(Home City\)](#)

Q9 The hand and/or day indicator are not aligned correctly.

Strong magnetism or impact can cause the hands and/or the indicator to go out of alignment. Correct hand and/or day indicator alignment.

[Correcting Hand and Day Indicator Alignment](#)

- Check the information below to find out how to align the hands and/or day indicator manually.

[Hand and Day Indicator Alignment](#)

Q10 The time setting is correct, but the day indicator is between days.

Is the date setting being updated?

For information about how the day changes, see the section below.

[Hand and Day Indicator Movement](#)

Other than the above.

The day indicator is not aligned correctly. Correct day indicator alignment.

[Correcting Hand and Day Indicator Alignment](#)

- Check the information below to find out how to align the hands and/or day indicator manually.

[Hand and Day Indicator Alignment](#)

Crown Operations

Q1 Nothing happens when I rotate the crown.

If you do not perform any operation for about two minutes after pulling out the crown (approximately 30 minutes in the case of hand and day indicator alignment), crown operations will automatically become disabled. Push the crown back in to its normal position and then pull it out again to re-enable crown operations.

[Using the Crown](#)

Q2 Crown operation does not work.

Crown operation is disabled while high-speed hand movement is in progress after a watch setting is changed, etc. Wait until the hands stop moving before performing crown operations.

Charging

Q1 The watch does not work even though it is exposed to light.

The watch stops operating whenever the battery goes dead. Keep the watch exposed to light until it recharges sufficiently.

[Charging](#)

Other

Q1 I can't find the information I need here.

Visit the website below.

<https://world.casio.com/support/>

Precautions

Operating Precautions

● Water Resistance

- The information below applies to watches with WATER RESIST or WATER RESISTANT marked on the back cover.

Water Resistance Under Daily Use

Marking on watch front or on back cover	No BAR mark
---	-------------

Example of Daily Use

Hand washing, rain	Yes
Water-related work, swimming	No
Windsurfing	No
Skin diving	No

Enhanced Water Resistance Under Daily Use

5 Atmospheres

Marking on watch front or on back cover	5BAR
---	------

Example of Daily Use

Hand washing, rain	Yes
Water-related work, swimming	Yes
Windsurfing	No
Skin diving	No

10 Atmospheres

Marking on watch front or on back cover	10BAR
---	-------

Example of Daily Use

Hand washing, rain	Yes
Water-related work, swimming	Yes
Windsurfing	Yes
Skin diving	Yes

20 Atmospheres

Marking on watch front or on back cover	20BAR
---	-------

Example of Daily Use

Hand washing, rain	Yes
Water-related work, swimming	Yes
Windsurfing	Yes
Skin diving	Yes

- Do not use your watch for scuba diving or other types of diving that requires air tanks.

- Watches that do not have WATER RESIST or WATER RESISTANT marked on the back cover are not protected against the effects of sweat. Avoid using such a watch under conditions where it will be exposed to large amounts of sweat or moisture, or to direct splashing with water.

- Even if a watch is water resistant, note the usage precautions described below. Such types of use reduce water resistance performance and can cause fogging of the glass.
 - Do not operate the crown or buttons while your watch is submersed in water or wet.
 - Avoid wearing your watch while in the bath.
 - Do not wear your watch while in a heated swimming pool, sauna, or any other high temperature/high humidity environment.
 - Do not wear your watch while washing your hands or face, while doing housework, or while performing any other task that involves soaps or detergents.

- After submersion in seawater, use plain water to rinse all salt and dirt from your watch.
- To maintain water resistance, have the gaskets of your watch replaced periodically (about once every two or three years).
- A trained technician will inspect your watch for proper water resistance whenever you have its battery replaced. Battery replacement requires the use of special tools. Always request battery replacement from your original retailer or from an authorized CASIO service center.
- Some water-resistant watches come with fashionable leather bands. Avoid swimming, washing, or any other activity that causes direct exposure of a leather band to water.

- The inside surface of the watch glass may fog when the watch is exposed to a sudden drop in temperature. No problem is indicated if the fogging clears up relatively quickly. Sudden and extreme temperature changes (such as coming into an air conditioned room in the summer and standing close to an air conditioner outlet, or leaving a heated room in the winter and allowing your watch to come into contact with snow) can cause it to take longer for glass fogging to clear up. If glass fogging does not clear up or if you notice moisture inside of the glass, immediately stop using your watch and take it to your original retailer or to an authorized CASIO service center.

- Your water-resistant watch has been tested in accordance with International Organization for Standardization regulations.

● Band

- Tightening the band too tightly can cause you to sweat and make it difficult for air to pass under the band, which can lead to skin irritation. Do not fasten the band too tightly. There should be enough room between the band and your wrist so you can insert your finger.

- Deterioration, rust, and other conditions can cause the band to break or come off of your watch, which in turn can cause band pins to fly out of position or to fall out. This creates the risk of your watch falling from your wrist and becoming lost, and also creates the risk of personal injury. Always take good care of your band and keep it clean.

- Immediately stop using a band if you even notice any of the following: loss of band flexibility, band cracks, band discoloration, band looseness, band connecting pin flying or falling out, or any other abnormality. Take your watch to your original retailer or to a CASIO service center for inspection and repair (for which you will be charged) or to have the band replaced (for which you will be charged).

● Temperature

- Never leave your watch on the dashboard of a car, near a heater, or in any other location that is subject to very high temperatures. Do not leave your watch where it will be exposed to very low temperatures. Temperature extremes can cause your watch to lose or gain time, to stop, or otherwise malfunction.

● Impact

- Your watch is designed to withstand impact incurred during normal daily use and during light activity such as playing catch, tennis, etc. Dropping your watch or otherwise subjecting it to strong impact, however, can lead to malfunction. Note that watches with shock-resistant designs (G-SHOCK, BABY-G, G-MS) can be worn while operating a chain saw or engaging in other activities that generate strong vibration, or while engaging in strenuous sports activities (motocross, etc.)

● Magnetism

- The hands of analog and combination (analog-digital) watches are moved by a motor that uses magnetic force. When such a watch is close to a device (audio speakers, magnetic necklace, cell phone, etc.) that emits strong magnetism, the magnetism can cause timekeeping to slow down, speed up, or stop, resulting in the incorrect time being displayed.
- Very strong magnetism (from medical equipment, etc.) should be avoided because it can cause malfunction of your watch and damage to electronic components.

● Electrostatic Charge

- Exposure to very strong electrostatic charge can cause your watch to display the wrong time. Very strong electrostatic charge even can damage electronic components.

● Chemicals

- Do not allow your watch to come into contact with thinner, gasoline, solvents, oils, or fats, or with any cleaners, adhesives, paints, medicines, or cosmetics that contain such ingredients. Doing so can cause discoloration of or damage to the resin case, resin band, leather, and other parts.

● Storage

- If you do not plan to use your watch for a long time, thoroughly wipe it free of all dirt, sweat, and moisture, and store it in a cool, dry place.

● Resin Components

- Allowing your watch to remain in contact with other items or storing it together with other items for long periods while it is wet can cause color on resin components to transfer to the other items, or the color of the other items to transfer to the resin components of your watch. Be sure to dry off your watch thoroughly before storing it and make sure it is not in contact with other items.
- Leaving your watch where it is exposed to direct sunlight (ultraviolet rays) for long periods or failure to clean dirt from your watch for long periods can cause it to become discolored.
- Friction caused by certain conditions (strong external force, sustained rubbing, impact, etc.) can cause discoloration of painted components.
- If there are printed figures on the band, strong rubbing of the printed area can cause discoloration.
- Leaving your watch wet for long periods can cause fluorescent color to fade. Wipe the watch dry as soon as possible after it becomes wet.
- Semi-transparent resin parts can become discolored due to sweat and dirt, and if exposed to high temperatures and humidity for long periods.
- Daily use and long-term storage of your watch can lead to deterioration, breaking, or bending of resin components. The extent of such damage depends on usage conditions and storage conditions.

● Leather Band

- Allowing your watch to remain in contact with other items or storing it together with other items for long periods while it is wet can cause the color of the leather band to transfer to the other items or the color of the other items to transfer to the leather band. Be sure to dry off your watch thoroughly with a soft cloth before storing it and make sure it is not in contact with other items.

- Leaving a leather band where it is exposed to direct sunlight (ultraviolet rays) for long periods or failure to clean dirt from a leather band for long periods can cause it to become discolored.

CAUTION:

Exposing a leather band to rubbing or dirt can cause color transfer and discoloration.

● Metal Components

- Failure to clean dirt from metal components can lead to formation of rust, even if components are stainless steel or plated. If metal components exposed to sweat or water, wipe thoroughly with a soft, absorbent cloth and then place the watch in a well-ventilated location to dry.
- Use a soft toothbrush or similar tool to scrub the metal with a weak solution of water and a mild neutral detergent, or with soapy water. Next, rinse with water to remove all remaining detergent and then wipe dry with a soft absorbent cloth. When washing metal components, wrap the watch case with kitchen plastic wrap so it does not come into contact with the detergent or soap.

● Bacteria and Odor Resistant Band

- The bacteria and odor resistant band protects against odor generated by the formation of bacteria from sweat, which ensures comfort and hygiene. In order to ensure maximum bacteria and odor resistance, keep the band clean. Use an absorbent soft cloth to thoroughly wipe the band clean of dirt, sweat, and moisture. A bacteria and odor resistant band suppresses the formation of organisms and bacteria. It does not protect against rash due to allergic reaction, etc.

Note that CASIO Computer Co., Ltd. assumes no responsibility for any damage or loss suffered by you or any third party arising through the use of your watch or its malfunction.

User Maintenance

● Caring for Your Watch

Remember that you wear your watch next to your skin, just like a piece of clothing. To ensure your watch performs at the level for which it is designed, keep it clean by frequently wiping with a soft cloth to keep your watch and band free of dirt, sweat, water and other foreign matter.

- Whenever your watch is exposed to sea water or mud, rinse it off with clean fresh water.
- For a metal band or a resin band with metal parts, use a soft toothbrush or similar tool to scrub the band with a weak solution of water and a mild neutral detergent, or with soapy water. Next, rinse with water to remove all remaining detergent and then wipe dry with a soft absorbent cloth. When washing the band, wrap the watch case with kitchen plastic wrap so it does not come into contact with the detergent or soap.
- For a resin band, wash with water and then wipe dry with a soft cloth. Note that sometimes a smudge like pattern may appear on the surface of a resin band. This will not have any effect on your skin or clothing. Wipe with a cloth to remove the smudge pattern.
- Clean water and sweat from a leather band by wiping with a soft cloth.
- Not operating a watch crown, buttons, or rotary bezel could lead to later problems with their operation. Periodically rotate the crown and rotary bezel, and press buttons to maintain proper operation.

● Dangers of Poor Watch Care

Rust

- Though the metal steel used for your watch is highly rust-resistant, rust can form if your watch is not cleaned after it becomes dirty.
 - Dirt on your watch can make it impossible for oxygen to come into contact with the metal, which can lead to breakdown of the oxidization layer on the metal surface and the formation of rust.
- Rust can cause sharp areas on metal components and can cause band pins to fly out of position or to fall out. If you ever notice any abnormality immediately stop using your watch and take it to your original retailer or to an authorized CASIO service center.
- Even if the surface of the metal appears clean, sweat and rust in crevasses can soil the sleeves of clothing, cause skin irritation, and even interfere with watch performance.

Premature Wear

- Leaving sweat or water on a resin band or bezel, or storing your watch an area subject to high moisture can lead to premature wear, cuts, and breaks.

Skin Irritation

- Individuals with sensitive skin or in poor physical condition may experience skin irritation when wearing a watch. Such individuals should keep their leather band or resin band particularly clean. Should you ever experience a rash or other skin irritation, immediately remove your watch and contact a skin care professional.

Battery

- The special rechargeable battery used by your watch is not intended to be removed or replaced by you. Use of a rechargeable battery other than the special one specified for your watch can damage your watch.
- The rechargeable (secondary) battery is charged when the solar panel is exposed to light, so it does not require regular replacement as the primary battery requires. Note, however, that long use or operating conditions can cause the capacity or charging efficiency of the rechargeable battery to deteriorate. If you feel that the amount of operation provided by charging is too short, contact your original retailer or CASIO service center.

Mobile Link Precautions

● Legal Precautions

- This watch complies with or has received approval under the radio laws of various countries and geographical areas. Using this watch in an area where it does not comply with or has not received approval under applicable radio laws may be a criminal offense. For details, visit the CASIO Website.

<https://world.casio.com/ce/BLE/>

- Use of this watch inside of aircraft is restricted under the aviation laws of each country. Be sure to follow the instructions of airline personnel.

● Precautions when using Mobile Link

- When using this watch in combination with a phone, keep the watch and phone close to each other. A range of two meters is recommended as a guideline, but the local environment (walls, furniture, etc.), the structure of a building, and other factors may require a much closer range.
- This watch can be affected by other devices (electrical devices, audio-visual equipment, office equipment, etc.) In particular, it can be affected by operation of a microwave oven. The watch may not be able to communicate normally with a phone if a microwave oven is operating nearby. Conversely, this watch may cause noise in radio reception and the video image of a TV.
- Bluetooth of this watch uses the same frequency band (2.4 GHz) as wireless LAN devices, and use of such devices in close proximity of this watch may result in radio interference, slower communication speeds and noise for the watch and the wireless LAN device, or even communication failure.

● Stopping Radio Wave Emission by This Watch

The watch is emitting radio waves whenever the second hand is pointing to [C]. Even if the second hand is not pointing at [C], the watch will automatically attempt to connect with a phone four times a day to adjust its time settings.

When in a hospital, on an aircraft, or in any other area where the use of radio waves is not allowed, use the operation below to stop radio wave generation.

● Stopping Radio Wave Generation

Press any button to terminate the Bluetooth connection.

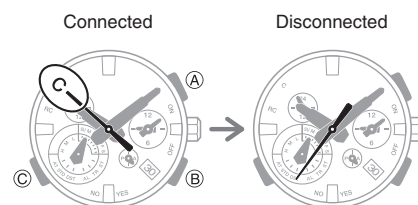

● Disabling Auto Time Correction

Configure CASIO WATCHES phone app settings to disable synchronization between the watch and phone.

[🔗 Using the Watch in a Medical Facility or Aircraft](#)