

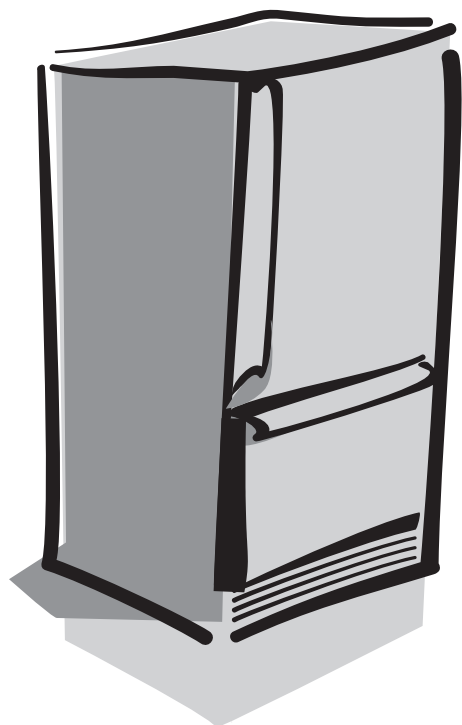

# Owner's Manual



## Bottom Freezer Refrigerator

### Questions about your features?

Please contact us with your model and serial number:

Maytag Appliances  
Attn: Amana CAIR® Center  
P.O. Box 39  
403 West 4th Street North  
Newton, Iowa 50208-0039  
Ph# 1-800-843-0304 in U.S.A.  
1-866-587-2002 au Canada  
Internet: [http:// www.amana.com](http://www.amana.com)

**Keep instructions for future reference.**

Keep this manual and your sales receipt together in a safe place in case warranty service is required.

### Contents

Introduction .....	2
Important Safety Information .....	3
Installing Your Refrigerator .....	4-11
Measuring the Opening .....	4
Transporting Your Refrigerator .....	4
Selecting the Best Location.....	4
How to Remove the Doors and Hinges.....	4
How to Reverse Refrigerator Door .....	5
How to Install and Remove Handles .....	6
How to Replace the Doors and Hinges.....	7
How to Remove and Install Panels .....	7
How to Remove and Install the Pullout Drawer .....	8
How to Connect the Water Supply .....	9
How to Level Your Refrigerator .....	10
How to Adjust the Temperature Controls .....	11
How to Perform A Temperature Test.....	11
About Your Water Filter.....	12
Water Filter Removal and Installation .....	12
Fresh Food Features .....	13-15
Water Dispenser .....	13
Interior Shelves.....	13
Door Storage .....	13
Climate-Controlled Drawers .....	14
Storage Drawers.....	14
Accessories .....	15
Freezer Features .....	16-17
Automatic Ice Maker.....	16
Shelves.....	16
Drawers .....	16
Door Storage .....	17
Accessories .....	17
Hints and Care .....	18-19
How to Clean Your Refrigerator .....	18
Removing Odors From Refrigerator .....	19
Energy Saving Ideas .....	19
How to Remove and Replace Light Bulbs .....	19
Trouble Shooting .....	20-22
Operation.....	21
Ice.....	22
Water Filter Data .....	23-24
Warranty .....	26

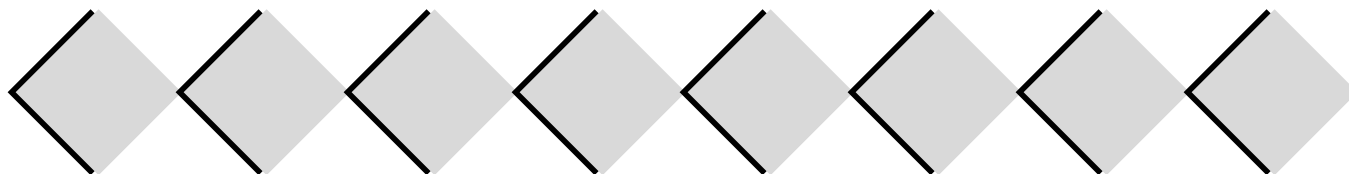

# THANK YOU FOR BUYING AN AMANA REFRIGERATOR!

Please read this Owner's Manual thoroughly. This manual provides proper maintenance information.

**Complete registration card and promptly return.** If registration card is missing, see contact information on the front cover of your manual.

**Warranty service must be performed by an authorized servicer.** Amana also recommends contacting an authorized servicer if service is required after warranty expires. To locate an authorized servicer, call **1-800-NAT-LSVC (1-800-628-5782)**. You may also contact us on the web at **www.amana.com**.

When contacting Amana, please provide the following information. Product information is on the serial plate, located on the interior of the fresh food section.

Model Number \_\_\_\_\_

'P' Number \_\_\_\_\_

Serial Number \_\_\_\_\_

Purchase Date \_\_\_\_\_

Dealer Name \_\_\_\_\_

Dealer Address \_\_\_\_\_

Dealer Phone \_\_\_\_\_

## ASURE™ EXTENDED SERVICE PLAN

Amana offers long-term service protection for this new refrigerator. **ASURE™ Extended Service Plan** is specially designed to supplement Amana's strong warranty. This plan covers parts, labor, and travel charges. Call **1-866-232-6244**, or contact us at **www.amana.com** for more information.

## BEFORE CALLING SERVICE...

If something seems unusual, please check **Trouble Shooting** section, which is designed to help you solve problems before calling service.

## WHAT IF THESE FEATURES ARE DIFFERENT FROM MINE?

This book is intended to show the variety of features that are available in the product line. If your refrigerator does not have all the options that are shown, many of these options may be purchased. See contact information on the front cover of your Owner's Manual.

# IMPORTANT SAFETY INFORMATION

## WHAT YOU NEED TO KNOW ABOUT SAFETY INSTRUCTIONS

Warning and Important Safety Instructions appearing in this manual are not meant to cover all possible conditions and situations that may occur. Common sense, caution, and care must be exercised when installing, maintaining, or operating refrigerator.

Always contact your dealer, distributor, service agent, or manufacturer about problems or conditions you do not understand.

## RECOGNIZE SAFETY SYMBOLS, WORDS, LABELS

### ⚠ DANGER

**DANGER** – Immediate hazards which **WILL** result in severe personal injury or death.

### ⚠ WARNING

**WARNING** – Hazards or unsafe practices which **COULD** result in severe personal injury or death.

### ⚠ CAUTION

**CAUTION** – Hazards or unsafe practices which **COULD** result in minor personal injury.

### ⚠ DANGER

To reduce risk of injury or death, follow basic precautions, including the following:

**IMPORTANT:** Child entrapment and suffocation are not problems of the past. Junked or abandoned refrigerators are still dangerous – even if they sit out for “just a few days.” If you are getting rid of your old refrigerator, please follow the instructions below to help prevent accidents.

Before you throw away your old refrigerator or freezer:

- > Take off the doors.
- > Leave the shelves in place so children may not easily climb inside.

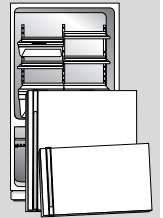

### ⚠ WARNING

To reduce risk of fire, electric shock, serious injury or death when using your refrigerator, follow these basic precautions, including the following:

1. Read all instructions before using the refrigerator.
2. Observe all local codes and ordinances.
3. Be sure to follow grounding instructions.
4. Check with a qualified electrician if you are not sure this appliance is properly grounded.
5. **DO NOT** ground to a gas line.
6. **DO NOT** ground to a cold-water pipe.
7. Refrigerator is designed to operate on a separate 103 to 126 volt, 15 amp., 60 cycle line. **DO NOT** modify plug on power cord. If plug does not fit electrical outlet, have proper outlet installed by a qualified electrician.
8. **DO NOT** use a two-prong adapter, extension cord or power strip.
9. **DO NOT** remove warning tag from power cord.
10. **DO NOT** tamper with refrigerator controls.
11. **DO NOT** service or replace any part of refrigerator unless specifically recommended in Owner's Manual or published user-repair instructions. **DO NOT** attempt service if instructions are not understood or if they are beyond personal skill level.
12. Always disconnect refrigerator from electrical supply before attempting any service. Disconnect power cord by grasping the plug, not the cord.
13. Install refrigerator according to Installation Instructions. All connections for water, electrical power and grounding must comply with local codes and be made by licensed personnel when required.
14. Keep your refrigerator in good condition. Bumping or dropping refrigerator can damage refrigerator or cause refrigerator to malfunction or leak. If damage occurs, have refrigerator checked by qualified service technician.
15. Replace worn power cords and/or loose plugs.
16. Always read and follow manufacturer's storage and ideal environment instructions for items being stored in refrigerator.

SAVE THESE INSTRUCTIONS

# INSTALLING YOUR REFRIGERATOR

These instructions are provided to aid you in the installation of your refrigerator. Amana cannot be responsible for improper installation.

## MEASURING THE OPENING

A one-half inch ( $\frac{1}{2}$ " ) of air space should be provided for the back of the refrigerator. When installing your refrigerator, measure carefully.

Subflooring or floor coverings (i.e. carpet, tile, wood floors, rugs) may make your opening smaller than anticipated.

Some clearance may be gained by using the leveling procedure under **How to Level Your Refrigerator** (page 10).

**IMPORTANT:** If refrigerator is to be installed into a recess where top of refrigerator is completely covered, use dimensions from floor to top of hinge cap to verify proper clearance.

## TRANSPORTING YOUR REFRIGERATOR

Follow these tips when moving the refrigerator to final location:

- **NEVER** transport refrigerator on its side. If an upright position is not possible, lay refrigerator on its back. Allow refrigerator to sit upright for approximately 30 minutes prior to plugging refrigerator in to assure oil return to the compressor. Plugging refrigerator in immediately may cause damage to internal parts.
- Use an appliance dolly when moving refrigerator. **ALWAYS** truck refrigerator from its side or back—**NEVER** from its front.
- Protect outside finish of refrigerator during transport by wrapping cabinet in blankets or inserting padding between the refrigerator and dolly.
- Secure refrigerator to dolly firmly with straps or bungee cords. Thread straps through handles when possible. **DO NOT** overtighten. Overtightening restraints may dent or damage outside finish.

## SELECTING THE BEST LOCATION

Observe these points when choosing the final location for your refrigerator:

- **DO NOT** install refrigerator near oven, radiator or other heat source. If not possible, shield refrigerator with cabinet material.
- **DO NOT** install where temperature falls below 55° F (13° C). Malfunction may occur at this temperature.
- To assure proper door closure, verify that the refrigerator is leveled with a  $\frac{1}{4}$ " tilt to the back.

## HOW TO REMOVE THE DOORS AND HINGES

Some installations require door removal to get refrigerator to final location. If removal of the pullout drawer is required, see later section entitled **How to Remove and Install the Pullout Drawer** (page 8).

### ⚠ WARNING

To avoid electrical shock which can cause severe personal injury or death, observe the following:

- Disconnect power to refrigerator before removing doors. Connect power only after replacing doors.

### ⚠ CAUTION

To avoid damage to walls and flooring, protect soft vinyl or other flooring with cardboard, rugs or other protective material.

1. Unplug power cord from power source.
2. Remove toe grille and bottom bracket cover(s).
  - Open freezer door as wide as possible.

- Depending on the model of your refrigerator, you may have one or two bracket covers.

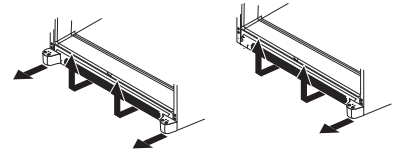

3. Remove top hinge cover from refrigerator door by removing Phillips screw.

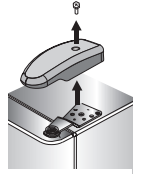

- Retain screw and cover for replacement.

4. Unscrew  $\frac{5}{16}$ " hex head screws from top hinge to remove hinge.

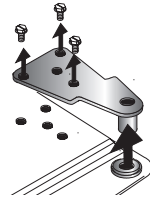

- Retain all screws for later use.

5. Lift refrigerator door from center hinge pin.

6. **For freezer door models only:** Hold freezer door while removing hinge pin with a  $\frac{5}{16}$ " hex head driver. Remove door from bottom hinge.

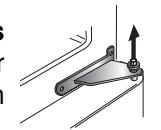

- Retain hinge pin for later use.

**For freezer drawer models only:** Remove center hinge pin with a  $\frac{5}{16}$ " hex head driver.

- Retain hinge pin for later use.

7. Remove Phillips screws to remove center hinge.

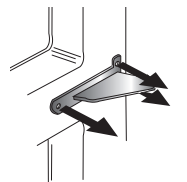

- Retain all screws for later use.

8. Remove bottom hinge or stabilizing bracket with  $\frac{3}{8}$ " hex head driver.

- Retain screws for later use.
- Lift out bottom hinge pin (some models).

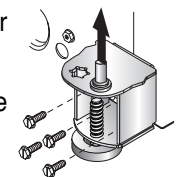

# HOW TO REVERSE REFRIGERATOR DOOR

## DOORS WITH TRIM AND PANELS

1. Perform all steps listed in **How to Remove the Door and Hinges** (page 4).

2. Transfer cabinet plugs and screws to opposite side of cabinet.

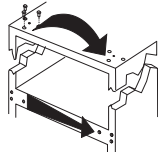

- Remove plugs with flat blade of screwdriver wrapped in masking tape.
- Remove center mullion screws with a  $\frac{5}{16}$ " hex head driver.
- **For swing doors only:** Remove bottom mullion screws with  $\frac{3}{8}$ " hex head driver.

### CAUTION

When working directly on doors, place doors on a nonabrasive surface protected by towels or rugs to avoid damage to door finish.

3. Locate door stop (A) and door cap (B) on bottom edge of fresh food door. Remove with a Phillips screwdriver.

- Retain all items for later replacement.



4. Remove top door extension with  $\frac{1}{4}$ " hex head driver. Flip door extension (A) so notched corner turns in toward interior of door (B).

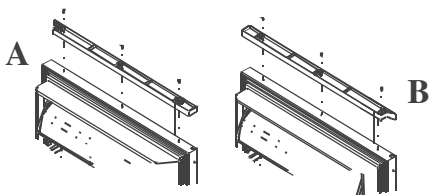

### WARNING

To avoid possible injury and damage to property, tape decorative panels (some models) securely into place before removing side door trim and handles.

5. Remove side door trim (A) and handle trim (B) from door by tapping bottom edges upward with soft rubber mallet.

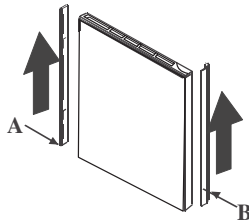

- Trim will slide up approximately  $\frac{3}{4}$ " and release from door.

6. Replace bottom door cap removed previously. Install door stop on opposite side of door.

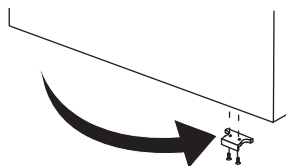

7. Retrieve alternate side door trim shipped with refrigerator. Install trim by aligning notches of trim with metal mounting tabs on side of door.

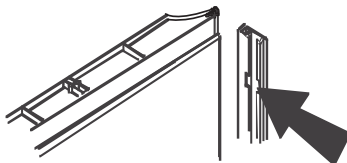

- Slide trim down until piece locks into place.
- Tap top of trim with rubber mallet to insure snug fit.

8. Remove tape from panels.

9. Proceed to **How to Install and Remove Handles** to reinstall handle (page 6).

## STANDARD DOOR DESIGN

1. Perform all steps listed in **How to Remove the Doors and Hinges** (page 4).

2. Transfer cabinet plugs and cabinet screws to opposite side of cabinet.

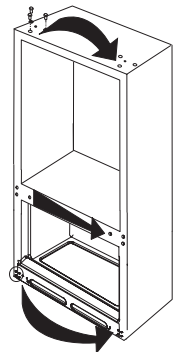

- Remove cabinet plugs with flat blade of screwdriver wrapped in masking tape.

- Remove center mullion screws with  $\frac{5}{16}$ " hex head screwdriver.

- **For swing doors only:** Remove bottom mullion screws with  $\frac{3}{8}$ " hex head driver.

### CAUTION

To avoid possible injury and damage to property:

- Place doors on a nonabrasive surface protected by towels or rugs while working directly on doors.

3. Transfer door stops from bottom edge of fresh food door and freezer door (some models) to opposite side of door edge.

- Use a Phillips screwdriver for removal and installation.



4. See **How to Install and Remove Handles** (page 6) to remove and reinstall handles.

5. Proceed to **How to Replace the Doors and Hinges** to mount doors (page 7).

# INSTALLING YOUR REFRIGERATOR, CONT.

## HOW TO INSTALL AND REMOVE HANDLES

For easier installation, some refrigerators may have been delivered with the handles off. Please see the interior of the fresh food section, or the back of your refrigerator, to locate the handle assembly. In case future transport of the refrigerator is necessary, or panels need to be removed and replaced, the removal instructions have been included here for your convenience.

Handle design may vary from refrigerator to refrigerator. Please reference the instructions for the appropriate handle design below.

### FRESH FOOD HANDLES

#### Installing Front-Mounted Handles

1. Remove ¼" hex head screws from door face with hex head driver, and a Phillips screw from top of door.
  - If reversing door, remove door plugs from opposite side of door and insert in screw holes.
2. Align handle holes with screw holes on door face and secure with 2 door face screws from step 1.
3. Locate handle trim in literature pack and install over top and bottom of handle, as illustrated.
  - Secure top handle trim with remaining screw removed in step 1.
  - Snap bottom trim over bottom portion of handle.

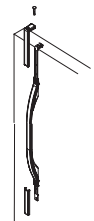
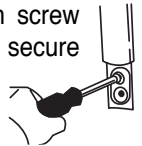
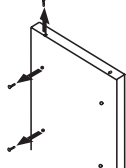

#### Installing Side-Mounted Handles

- Install handle by fastening with screws\* removed from edge of door.
- NOTE:** If reversing door, remove door plugs from opposite side of door and insert in screw holes.

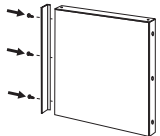

#### Installing Stainless Steel Front-Mounted Handles

1. Loosen door clip on door with ¼" hex head driver.
  2. Locate predrilled hole at base of handle, and fit hollow end of handle over door clip.
  3. Fit other end of handle over other door clip and slide up as far as possible.
- NOTE:** If top of handle does not fit over top clip, loosen lower clip further until fit can be accomplished.
4. Insert ¼" hex head driver into predrilled hole at base of handle to tighten screw. Insert screw plug(s) into hole(s), as illustrated.

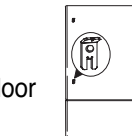

#### Installing Trim and Panel Extruded Handles

1. Make sure bottom door cap is installed and top door cap is removed.
  - Use a Phillips screwdriver for installation and removal.
2. Install handle by aligning handle notches with metal mounting tabs on side of door.
  - Slide handle down until piece locks.
  - Tap top of handle with rubber mallet to insure snug fit.

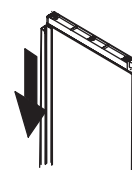

**IMPORTANT:** If reversing trim and panel door, use alternate top hinge shipped with refrigerator.

3. Install top door cap with Phillips screwdriver.

#### Removing Front-Mounted Handles

1. Remove top handle trim by removing top handle screw.
  - Retain trim and screw for later replacement.
2. Pry bottom handle trim from handle with screwdriver flat blade wrapped in masking tape.
  - Retain trim for later replacement.
3. Remove two ¼" hex head screws.
  - Retain trim for later replacement.

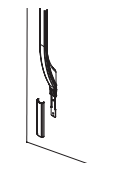
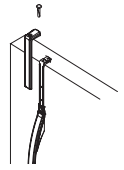

#### Removing Side-Mounted Handles

- Remove handle by removing three screws\* from side of door.
  - Retain screws for later replacement.

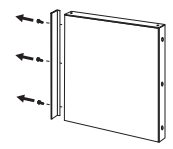

#### Removing Stainless Steel Front-Mounted Handles

1. Remove screw plug at base of handle with a very small flat-blade screwdriver.
  - Insert ¼" hex head driver into predrilled hole to remove screw.
2. Slide handle down to remove from door clip.

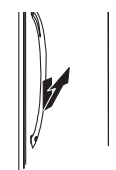

#### Removing Trim and Panel Extruded Handles

1. Make sure bottom door cap is installed and top door cap is removed.
  - Use a Phillips screwdriver for installation and removal.
2. Remove handle (A) from door by tapping bottom edge upward with soft rubber mallet.

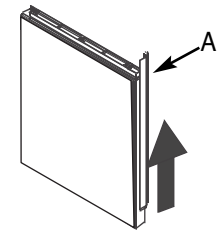

\* Fasteners may require either a T-15 Torx® driver or a Phillips screwdriver. Torx® is a registered trademark of Textron Inc.

## FREEZER HANDLES

### Installing Partial-Width Extruded Handle

- Install handle by fastening with screws removed from edge of door.

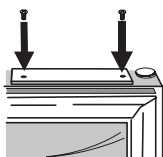

- If reversing freezer door, remove door plugs from top edge of door and insert into screw holes.

### Installing Full-Width/Trim and Panel Extruded Handle

- Install handle by fastening with screws\* removed from edge of door.

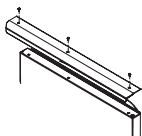

### Removing Partial-Width Extruded Handle

- Remove handle screws with Phillips screwdriver.

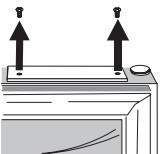

- Retain screws for later replacement.

### Removing Full-Width/Trim and Panel Extruded Handle

- Remove handle by removing three screws\* from handle.

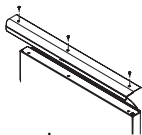

- Retain screws for later replacement.

## HOW TO REPLACE THE DOORS AND HINGES

### 1. Install hinge assemblies.

- Install top hinge loosely with  $\frac{5}{16}$ " hex head screws.
- Install center hinge with Phillips screws.
- Install bottom hinge with  $\frac{3}{8}$ " hex head screws.

### 2. Insert bottom hinge pin (some models).

- Locate bottom hinge hole closest to outside edge of cabinet, and insert bottom hinge pin. Replace any door shims, if present.

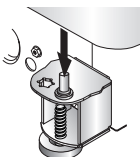

### 3. For freezer door models only:

- Place hinge side of freezer door on bottom hinge pin and hold freezer door upright while installing center hinge pin with  $\frac{5}{16}$ " hex head driver.

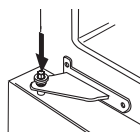

- Replace any applicable door shims.
- Make sure the hinge pin is installed tightly.

- For freezer drawer models only:** Install center hinge pin with a  $\frac{5}{16}$ " hex head driver.

- Replace any applicable door shims.
- Make sure the hinge pin is installed tightly.

### 4. Place hinge side of refrigerator door on center hinge pin.

- 5. While holding refrigerator door upright, tighten down top hinge with  $\frac{5}{16}$ " hex head driver and replace hinge cover.

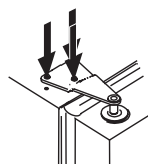

## HOW TO REMOVE AND INSTALL PANELS

### (SOME MODELS)

#### ⚠ WARNING

To avoid personal injury or property damage, fresh food panel should not weigh more than 30 lbs (14 kgs) and freezer panel should not weigh more than 15 lbs (7 kgs).

- To remove panels, remove door handle and slide panel out the handle side of door.

- Install panels by sliding panel in grooves provided by bottom door cap and side trim.

- Replace the handles, when completed.

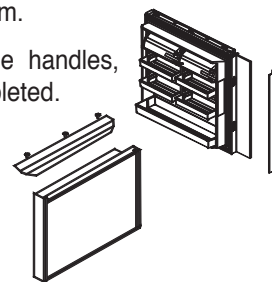

## WHAT IF I AM INSTALLING RAISED PANELS?

If raised panels are used, allow  $2\frac{1}{2}$ " (A) minimum clearance between raised edge of panel and handle.

Please see the recommended dimensions for panelling.

**Raised Panel B** – 42" x 35 $\frac{5}{8}$ "  
(106.7 cm x 90.5 cm)

**Raised Panel C** – 23 $\frac{1}{4}$ " x 36 $\frac{1}{16}$ "  
(59.1 cm x 91.6 cm)

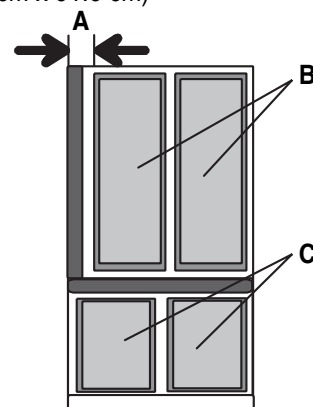

\* Fasteners may require either a T-15 Torx® driver or a Phillips screwdriver. Torx® is a registered trademark of Textron Inc.

# INSTALLING YOUR REFRIGERATOR, CONT.

## HOW TO REMOVE AND INSTALL THE PULLOUT DRAWER

### ⚠ DANGER

To prevent accidental child entrapment or suffocation risk, DO NOT remove the divider in the top freezer basket.

### ⚠ WARNING

To avoid electrical shock which can cause severe personal injury or death, disconnect power to refrigerator before removing doors. After replacing doors, connect power.

### ⚠ CAUTION

To avoid possible injury, product, or property damage, you will need two people to perform the following instructions.

#### To remove:

1. Pull upper basket out to full extension and lift out to remove.

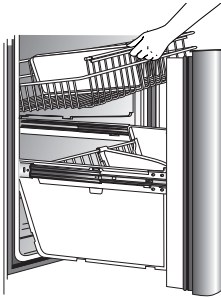

2. Remove lower basket by pressing inward on basket sides, then lift basket.

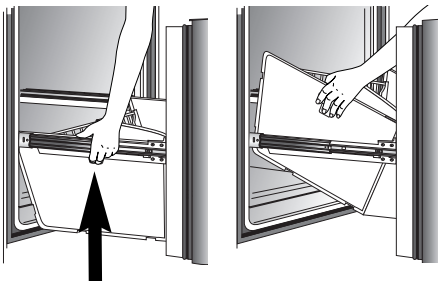

Press Tab Here

3. Pull drawer open to full extension.
4. Remove Phillips screw from each side of rail system. (Some models)

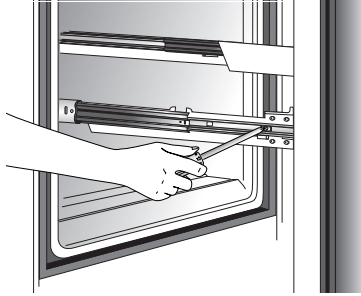

5. Lift top of door to unhook door supports from rail system. Lift door out to remove.

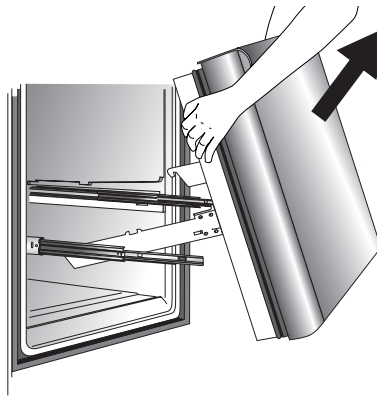

#### To install:

1. Pull both rails out to full extension.

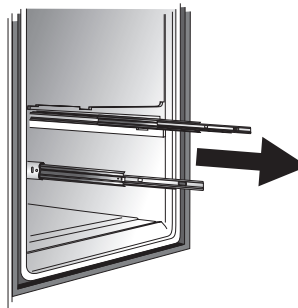

2. While supporting door, hook door supports into tabs located on inside of rail.

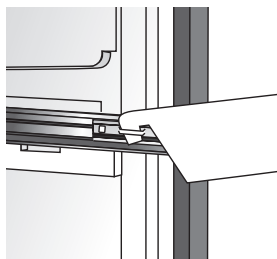

3. Lower door into final position.
4. Replace and tighten Phillips screws that were removed from each side of rail system.

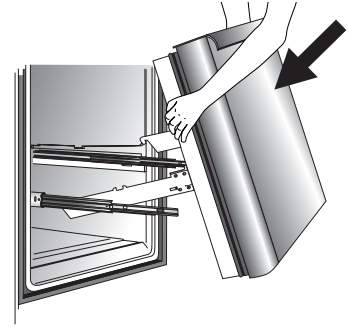

5. With drawer pulled out to full extension, insert lower basket by aligning tabs on both sides of lower basket with notches in rail assembly. Verify that the basket sides are hooked securely over the rails.

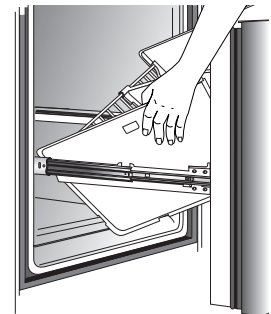

6. Slide upper basket into freezer. Make sure that rear of basket hooks behind rail catch.

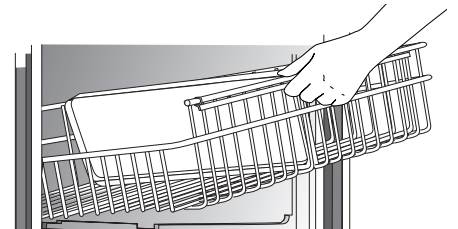

# HOW TO CONNECT THE WATER SUPPLY

(SOME MODELS)

## ⚠ WARNING

To reduce the risk of injury or death, follow basic precautions, including the following:

- Read all instructions before installing device.
- DO NOT attempt installation if instructions are not understood or if they are beyond personal skill level.
- Observe all local codes and ordinances.
- DO NOT service device unless specifically recommended in Owner's Manual or published user-repair instructions.
- Disconnect power to refrigerator prior to installing device.

## ⚠ CAUTION

To avoid property damage or possible injury, follow basic precautions, including the following:

- Consult a plumber to connect copper tubing to household plumbing to assure compliance with local codes and ordinances.
- Confirm water pressure to water valve is between 20 and 100 pounds per square inch. If water filter is installed, water pressure to water valve must be a minimum of 35 pounds per square inch.
- DO NOT use a self-piercing, or  $\frac{3}{16}$ " saddle valve! Both reduce water flow, become clogged with time, and may cause leaks if repair is attempted.
- Tighten nuts by hand to prevent cross threading. Finish tightening nuts with pliers and wrenches. Do not overtighten.
- Wait 24 hours before placing refrigerator into final position to check and correct any water leaks.

## MATERIALS NEEDED

- $\frac{1}{4}$ " outer diameter flexible copper tubing
- Shut-off valve (requires a  $\frac{1}{4}$ " hole to be drilled into water supply before valve attachment)
- Adjustable wrench
- $\frac{1}{4}$ " hex nut driver

**NOTE:** Add 8' to tubing length needed to reach water supply for creation of service loop.

1. Create service loop with tubing using care to avoid kinks in tubing.

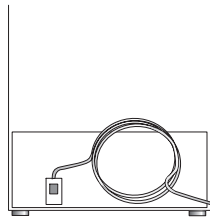

2. Remove plastic cap from water valve inlet port.



3. Place brass nut (A) and sleeve (B) on copper tube end as illustrated.

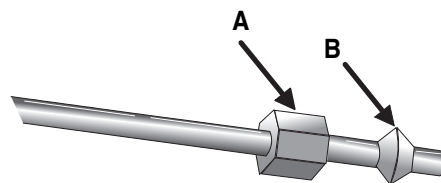

4. Place end of copper tubing into water valve inlet port. Shape tubing slightly – DO NOT KINK – so that tubing feeds straight into inlet port.



5. Slide brass nut over sleeve and screw nut into inlet port. Tighten nut with wrench.

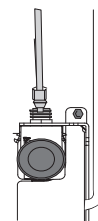

**IMPORTANT:** DO NOT overtighten. Cross threading may occur.

6. Pull on tubing to confirm connection is secure. Connect tubing to frame with water tubing clamp (C) and turn on water supply. Check for leaks and correct, if present.

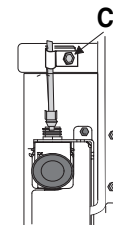

7. Monitor water connection for 24 hours. Correct leaks, if necessary.

# INSTALLING YOUR REFRIGERATOR, CONT.

## HOW TO LEVEL YOUR REFRIGERATOR

If your refrigerator requires an ice maker water supply connection, proceed to **How to Connect the Water Supply** (page 9) section before leveling your refrigerator.

### ⚠ CAUTION

To protect personal property or refrigerator from damage, observe the following:

- Protect soft vinyl or other flooring with cardboard, rugs, or other protective material.
- Do not use power tools when performing leveling procedure.

### MATERIALS NEEDED

- 3/8" hex head driver
- Level

1. Remove toe grille and bottom hinge covers (see previous instructions).
2. Turn both front adjustment screws (A) clockwise to raise and counterclockwise to lower.

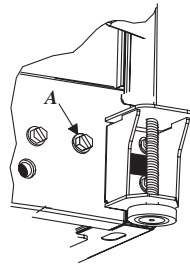

3. Turn both rear adjustment screws (B) clockwise to raise and counterclockwise to lower.

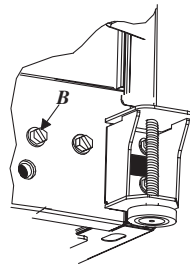

4. Turn stabilizing legs (C) clockwise until firmly against floor.

- **For Pullout Drawer Models:** After completing the above listed steps, turn roller adjustment screws (A) 2 to 3 times counterclockwise, so that full weight of refrigerator rests on stabilizing legs.

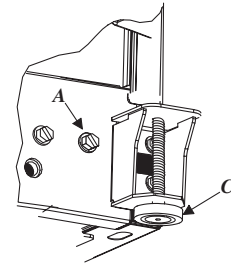

5. Using a level, make sure front of refrigerator is 1/4" (6 mm) or 1/2 bubble higher than back of refrigerator. See leveling step 3 for assistance.

6. Replace toe grille and bracket cover(s). See markings on inside of toe grille to insure proper placement.

- **Snap bottom portion into place first.** Press down on top part of grille until top portion snaps into place.

# HOW TO ADJUST THE TEMPERATURE CONTROLS

The controls are located at the top front of the refrigerator and freezer compartments. **NOTE:** The freezer control turns the cooling system on. Neither section will cool if freezer control is set to off.

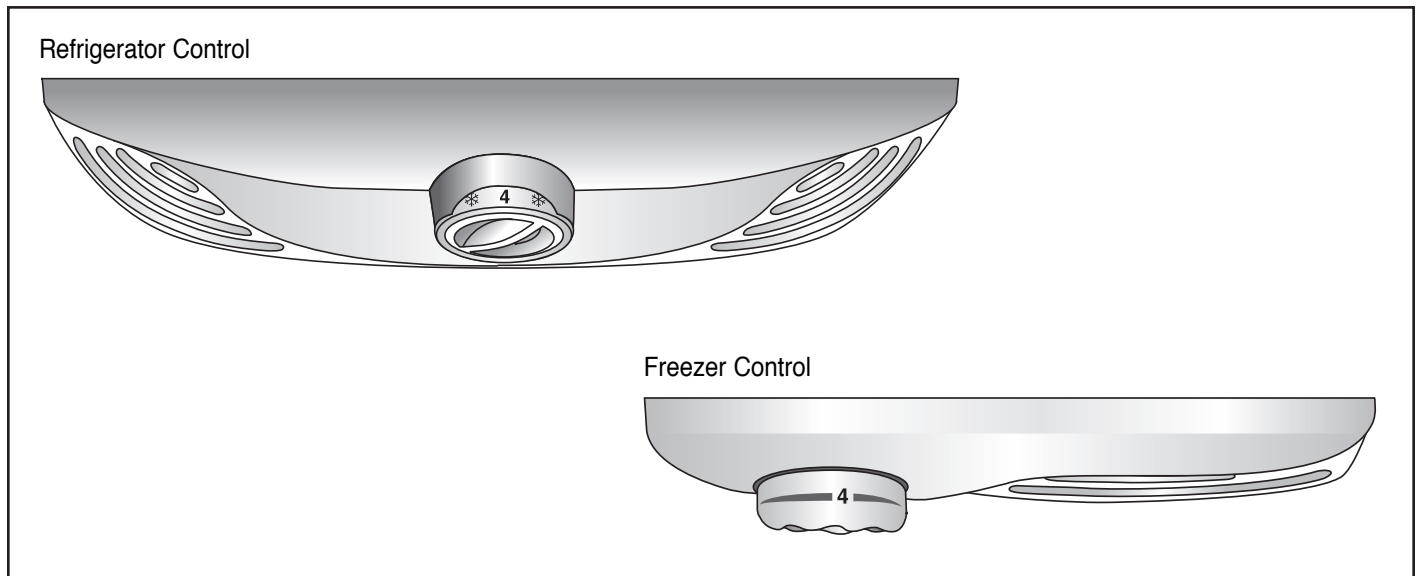

This refrigerator is designed to operate at a household temperature of 55° to 110° F (13° to 43° C). For initial temperature setting, follow all five steps listed below. If simply adjusting the temperature for an operational refrigerator, only steps 3 through 5 are required.

1. Locate refrigerator controls at the top of fresh food compartment and freezer controls at top of freezer section. Set both controls to 4.
2. Allow 24 hours for temperatures to stabilize.
3. Check to see if freezer temperature is 0° to 2° F (-17° to -16° C).
  - Turn control to next highest number if too warm.
  - Turn control to next lowest number if too cold. Allow 5 to 8 hours for adjustments to take effect.

4. Check to see that fresh food section is 38° to 40° F (3° to 4° C).
  - Turn control to next highest number if too warm.
  - Turn control to next lowest number if too cold.
  - Allow 5 to 8 hours for adjustments to take effect.
5. Repeat steps 3 & 4, as necessary.

## HOW TO PERFORM A TEMPERATURE TEST

### MATERIALS NEEDED

- 2 thermometers measuring -5° to 50° F (-21° to 10° C)
- 2 drinking glasses

### For Freezer

- Place thermometer in glass of vegetable oil in middle of freezer and continue with step 3 of temperature adjustment section.

**IMPORTANT:** Always start temperature adjustments with freezer section.

### For Refrigerator

- Place thermometer in glass of water in middle of refrigerator and continue with step 3 of temperature adjustment section.

# ABOUT YOUR WATER FILTER...

## WATER FILTER REMOVAL AND INSTALLATION

### ⚠ WARNING

To avoid serious illness or death, do not use refrigerator where water is unsafe or of unknown quality without adequate disinfection before or after use of filter.

### ⚠ CAUTION

- Bypass cartridge DOES NOT filter water. Be sure to have replacement cartridge available when filter change is required.
- If water filtration system has been allowed to freeze, replace filter cartridge.
- If system has not been used for several months, and water has an unpleasant taste or odor, flush system by dispensing 2–3 glasses of water. If unpleasant taste or odor persists, change filter cartridge.

## INITIAL INSTALL OF WATER FILTER

1. Remove blue bypass cap and retain for later use.

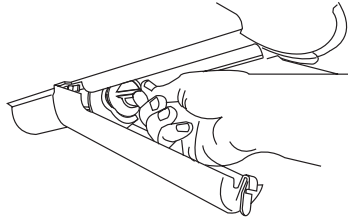

2. Remove sealing label from end of filter and insert into filter head.
3. Rotate gently clockwise until filter stops, and snap filter cover closed.

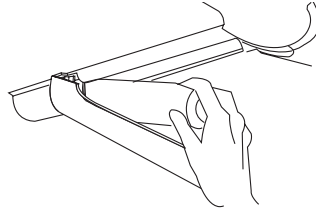

4. Reduce water spurts by flushing air from system. Run water continuously for 2 minutes through dispenser until water runs steady.
  - Additional flushing may be required in some households where water is of poor quality.

## REPLACING WATER FILTER

**IMPORTANT:** Air trapped in system may cause water and cartridge to eject. Use caution when removing.

1. Turn filter counterclockwise until it releases from filter head.
2. Drain water from filter into sink, and dispose in normal household garbage.
3. Wipe up excess water in filter cover and continue with **Initial Install of Water Filter**, steps 2 and 3.

## WHEN DO I CHANGE THE WATER FILTER?

The filter should be changed approximately every 6 months.

**IMPORTANT:** Condition of water and amount used determines life span of water filter cartridge. If water use is high, or if water is of poor quality, replacement may need to take place more often.

## HOW DO I ORDER A REPLACEMENT FILTER CARTRIDGE?

Amana® Replacement Water Filter cartridge model WF 50 is available through Amana® dealers and servicers. You may also order by calling 1-877-232-6771 within the U.S., or visit our local website [www.amana.com](http://www.amana.com).

## I'M TRYING TO DISPENSE WATER TO FLUSH THE SYSTEM. WHERE'S THE WATER?

During initial use, allow about a 1 to 2 minute delay in water dispersal to allow internal water tank to fill.

## WHAT IF I CHOOSE NOT TO USE THE WATER FILTRATION SYSTEM?

Dispenser feature may be used without water filter cartridge. If you choose this option, replace filter with blue bypass cap.

# FRESH FOOD FEATURES

## WATER DISPENSER

(SOME MODELS)

The **Water Dispenser** is located on the left side wall of the fresh food section. This design is for cold water dispensing only.

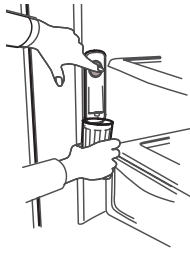

**To dispense water:**

- Hold container under spout and press dispenser pad.

## INTERIOR SHELVES

### ⚠ CAUTION

To avoid personal injury or property damage, observe the following:

- Confirm shelf is secure before placing items on shelf.
- Handle tempered glass shelves carefully. Shelves may break suddenly if nicked, scratched, or exposed to sudden temperature change.

## SPILLSAVER™

(SOME MODELS)

**Spillsaver™ Stationary Shelves** hold simple spills for easier cleaning.

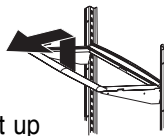

- To remove shelves, lift up and out.
- To install shelves, reverse above procedure.

Some models feature the **Spillsaver™ EasyGlide™ Shelves**.

EasyGlide™ shelves feature the convenience of easy cleaning with a pullout design to reach items in the back. For ease of cleaning, glass shelf may be removed by pulling to full extension and lifting out of frame.

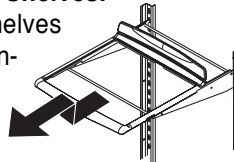

- To remove shelf and frame, see previous instructions for Spillsaver™.

## REAR SHELF EXTENSIONS

(SOME MODELS)

**Rear Shelf Extensions** help prevent articles from falling off the back of the shelf.

**To remove and install shelf extension:**

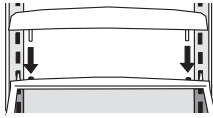
- To remove, pull extension straight up from rear of shelf.
- 
- To install, insert posts of the shelf extension into holes in the shelf frame.

## DOOR STORAGE

### DAIRY CENTER

The **Dairy Center** provides convenient storage for items such as butter, yogurt, cheese, etc.

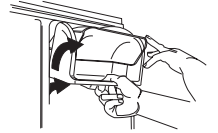

This compartment is an adjustable feature located in the door. It can be moved to several different locations to accommodate storage needs.

- To remove, open dairy door, pull upward and tilt out.
- To install, reverse above procedure.

### DOOR BUCKETS

**Door Buckets** adjust to meet individual storage needs.

- To remove, slide bucket up and pull straight out.

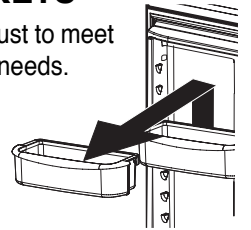

- To install, reverse above procedure.

### FULL-WIDTH DOOR SHELF

**Full-Width Door Shelf** removes for easy cleaning.

- To remove, slide shelf up and pull straight out.
- To install, reverse above procedure.

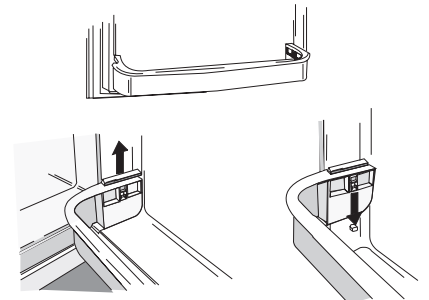

# FRESH FOOD FEATURES, CONT.

## CLIMATE-CONTROLLED DRAWERS

### HUMIDITY-CONTROLLED CRISPER DRAWERS

The **Crisper Drawer** keeps produce fresh longer by providing an environment with adjustable humidity.

#### Controls

The **crisper controls** regulate the

amount of humidity in the crisper drawer. Use the **low** setting for produce with outer skins. Use the **high** setting for leafy produce.

#### To remove and install crisper drawers:

- To remove drawer, pull drawer out to full extension. Tilt up front of drawer and pull straight out.
- To install, insert drawer into frame rails and push back into place.

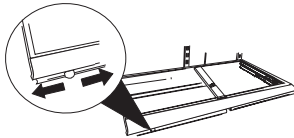

### PRODUCE STORAGE TIPS

Please observe the following rules when storing produce in humidity-controlled crisper drawers:

- DO NOT wash produce before placing in crispers. Any additional moisture added to the drawers may cause produce to prematurely spoil.
- DO NOT line crispers with paper towels. Towels will retain moisture.
- DO NOT place leafy vegetables in the temperature-controlled drawer. Colder temperatures will damage leafy produce.
- Follow control instructions carefully. Not setting controls correctly may damage produce.

See chart below for assistance with humidity drawer controls:

<b>LOW</b>	• cauliflower	• apples
	• corn	• oranges
	• zucchini	• grapes
	• cucumbers	
<b>HIGH</b>	• lettuce	• asparagus
	• spinach	• cabbage
	• celery	• broccoli
	• fresh sprouts	• fresh herbs

### TEMPERATURE-CONTROLLED DRAWER

#### Chef's Pantry™

The **Chef's Pantry™** system provides a drawer with a variable temperature control that keeps the compartment colder than refrigerator temperature. This drawer can be used for large party trays, deli items, or beverages.

#### Control

The **Chef's Pantry™** control regulates the air temperature in the drawer. Set control level to **cold** to provide normal refrigerator temperature. Use the **coldest** setting for meats or other deli items.

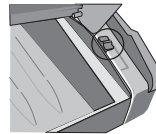

**NOTE:** Cold air directed to the Chef's Pantry™ can decrease refrigerator temperature. Refrigerator control may need to be adjusted.

#### To remove and install pantry:

- To remove drawer, lift lid and pull drawer out to full extension. Tilt up front of pantry and pull straight out.
- To install, push metal glide rails to the back of the refrigerator. Place drawer onto rails and slide drawer back until it falls into place.

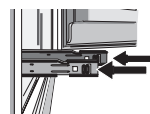
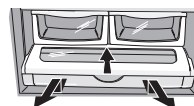

### HOW DO I REMOVE THE GLASS AND CRISPER FRAME IF I WANT TO CLEAN IT?

Some drawers feature glass shelves that can be removed for easy cleaning.

- Remove drawers as indicated above.
- Place hand beneath the frame to push up glass from underneath. Lift glass out.
- Lift frame from refrigerator liner rails.
- To install, repeat above instructions in reverse order.

## STORAGE DRAWERS

### SNACK DRAWER

#### (SOME MODELS)

The **Snack Drawer** can be used for storage of miscellaneous items or extra produce.

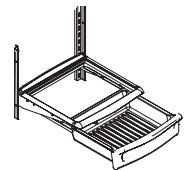

Some models feature a control that regulates the air temperature in the drawer. Set the control level to **cold** to provide normal refrigerator temperature. Use the **coldest** setting for meats and other deli items.

#### To remove and install drawer:

- To remove drawer, pull drawer out to full extension. Tilt up front of drawer and pull straight out.
- To install, insert drawer into frame rails and push back into place.

### BEVERAGE ORGANIZER™

#### (SOME MODELS)

The **Beverage Organizer™** slides out from underneath the Spillsaver™ stationary shelf. The Beverage Organizer™ holds up to twelve 12-ounce beverage cans.

#### To remove and install organizer:

- To remove drawer, pull drawer out to full extension. Tilt up front of drawer and pull straight out.
- To install, insert drawer into frame rails and push back into place.

## ACCESSORIES

### GRIP PADS (SOME MODELS)

The **Grip Pads** prevent objects from sliding in the door bucket. Grip Pads are removable and are top-rack dishwasher safe for easy cleaning.

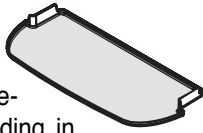

### WINE TRIVET/CAN RACK (SOME MODELS)

The **Wine Trivet/Can Rack** accessory fits in the bottom of most drawer assemblies.

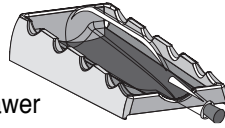

Bottles can be laid crosswise, or a single bottle may be laid in the center depression. Cans may also be stored, as illustrated.

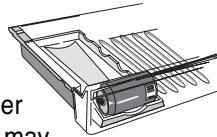

### PANTRY DIVIDER (SOME MODELS)

The **Pantry Divider** is used to organize the Chef's Pantry™ into sections.

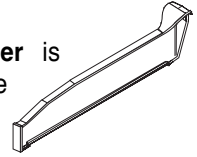

#### To remove and replace divider:

- To remove, raise front of divider to unhook divider from rear wall of pantry, and pull out.



- To install, hook back of divider over rear wall of pantry and lower into place.

**NOTE:** For easiest removal and replacement, remove pantry. If removal is not possible, pull drawer open to its fullest extension.

# FREEZER FEATURES

## AUTOMATIC ICE MAKER

(SOME MODELS)

### ⚠ CAUTION

To avoid property damage, observe the following:

- Do not force ice maker arm down or up.
- Do not place or store anything in ice storage bin.

### Using Ice Maker for the First Time

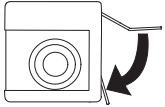
1. Confirm ice bin is in place and ice maker arm is down. 
2. After freezer section reaches between 0° to 2° F (-18° to -17° C), ice maker fills with water and begins operating.
3. Allow approximately 24 hours after installation to receive first harvest of ice.
4. Discard ice created within first 12 hours of operation to verify system is flushed of impurities.

### Operating Instructions

1. Confirm ice bin is in place and ice maker arm is down.
2. After freezer section reaches 0° to 2° F (-18° to -17° C), ice maker fills with water and begins operating. You will have a complete harvest of ice approximately every 3 hours.
3. Stop ice production by raising ice maker arm until click is heard. 
4. Ice maker will remain in the *off* position until arm is pushed down.

## SHELVES

### ICE SERVICE RACK

To install and remove rack:

- To install, slide L-shaped groove of shelf down over back wall screw. Push rack back until screw is stopped in L-shaped groove (1). Slide front portion of shelf over front wall screw (2). 

- To remove, perform above steps in reverse order.

### FIXED FREEZER SHELF

To remove and install shelves:

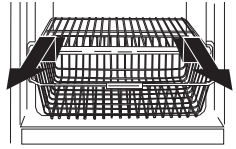
- Remove shelf by pulling out to full extension. Tilt up front of shelf and pull straight out. 
- To install, insert shelf into refrigerator liner rails and push to back of compartment.

### SLIDE-OUT FREEZER SHELF

To remove and install shelves:

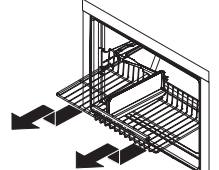
- Remove shelf by pulling out to full extension. Tilt up front of shelf and pull straight out. 
- To install, insert shelf into refrigerator liner rails and push to back of compartment.

## DRAWERS

### WIRE BASKET

To remove and install basket:

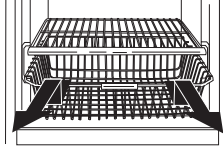
- To remove basket, pull basket out to full extension. Tilt up front of basket and pull straight out. 
- To install, insert basket into refrigerator liner rails and push back into place.

### PULLOUT DRAWER BASKETS

(SOME MODELS)

(Door assembly of drawer removed from illustration for visual clarity.)

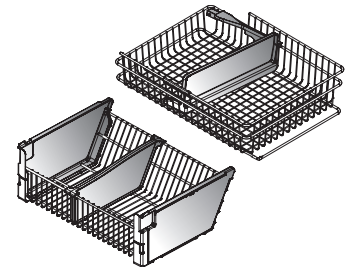

To remove and replace baskets:

- See page 8 for basket removal and replacement instructions.

### ⚠ DANGER

To prevent accidental child entrapment or suffocation risk, **DO NOT** remove the divider in the top freezer basket.

## DOOR STORAGE

### FIXED DOOR SHELF (SOME MODELS)

The **Fixed Door Shelf** provides convenient storage for frozen food items in freezer door.

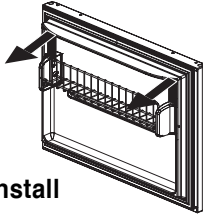

#### To remove and install door shelf:

- To remove shelf, lift assembly from side liner tabs and pull out.
- To install, fit ends of shelf assembly on liner tabs and slide down.

### TILT-OUT BIN (SOME MODELS)

The **Tilt-Out Bin (A)** provides convenient storage for frozen food items in freezer door and tilts forward for easy access of those items.

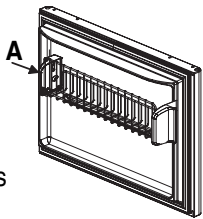

#### To remove and install door shelf:

- See above instructions listed for Fixed Door Shelf.

## ACCESSORIES

### ICE CUBE TRAY (SOME MODELS)

The **Ice Cube Tray** provides an area to freeze cubes for manual dispensing of ice.

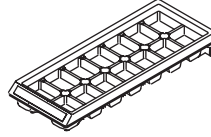

To release ice cubes from tray, hold tray upside down over a storage container and twist both ends of tray until cubes release.

### LOWER BASKET DIVIDER (SOME MODELS)

The **Lower Basket Divider** allows the option to organize the basket area into sections.

#### To remove and replace divider:

- To remove, pull divider straight up.
- To install, hook top corners of divider over top horizontal basket rungs.

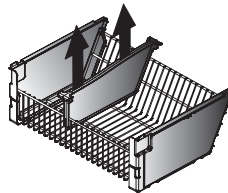

# HINTS AND CARE

## HOW TO CLEAN YOUR REFRIGERATOR

### ⚠️ WARNING

To avoid electrical shock which can cause severe personal injury or death, disconnect power to refrigerator before cleaning. After cleaning, connect power.

### ⚠️ CAUTION

To avoid personal injury or property damage, observe the following:

- Read and follow manufacturer's directions for all cleaning products.
- **DO NOT** place buckets, shelves or accessories in dishwasher. Cracking or warping of accessories may result.

PART	DO NOT USE	DO
<b>Textured Doors and Exterior</b> <b>Cabinet Interior</b>	<ul style="list-style-type: none"> <li>➤ Abrasive or harsh cleaners</li> <li>➤ Ammonia</li> <li>➤ Chlorine bleach</li> <li>➤ Concentrated detergents or solvents</li> <li>➤ Metal or plastic-textured scouring pads</li> </ul>	<ul style="list-style-type: none"> <li>➤ Use 4 tablespoons of baking soda dissolved in 1 quart (1 liter) warm soapy water.</li> <li>➤ Rinse surfaces with clean warm water and dry immediately to avoid water spots.</li> </ul>
<b>Stainless Steel Doors and Exterior</b> <b>IMPORTANT:</b> <i>Damage to stainless steel finish due to improper use of cleaning products or non-recommended products is not covered under this product's warranty.*</i>	<ul style="list-style-type: none"> <li>➤ Abrasive or harsh cleaners</li> <li>➤ Ammonia</li> <li>➤ Chlorine bleach</li> <li>➤ Concentrated detergents or solvents</li> <li>➤ Metal or plastic-textured scouring pads</li> <li>➤ Vinegar-based products</li> <li>➤ Citrus-based cleaners</li> </ul>	<ul style="list-style-type: none"> <li>➤ Use warm, soapy water and a soft, clean cloth or sponge.</li> <li>➤ Rinse surfaces with clean warm water and dry immediately to avoid water spots.</li> </ul>
<b>Door Gaskets</b>	<ul style="list-style-type: none"> <li>➤ Abrasive or harsh cleaners</li> <li>➤ Metal or plastic-textured scouring pads</li> </ul>	
<b>Condenser Coil</b> <i>Remove base grille to access</i>		<ul style="list-style-type: none"> <li>➤ Use a vacuum cleaner hose nozzle.</li> </ul>
<b>Condenser Fan Outlet Grille</b> <i>See back of refrigerator</i>		<ul style="list-style-type: none"> <li>➤ Use a vacuum cleaner hose nozzle with brush attachment.</li> </ul>
<b>Accessories</b> <i>Shelves, buckets, drawers, etc.</i>	<ul style="list-style-type: none"> <li>➤ A dishwasher</li> </ul>	<ul style="list-style-type: none"> <li>➤ Follow removal and installation instructions from appropriate feature section.</li> <li>➤ Allow items to adjust to room temperature.</li> <li>➤ Dilute mild detergent and use a soft clean cloth or sponge for cleaning.</li> <li>➤ Use a plastic bristle brush to get into crevices.</li> <li>➤ Rinse surfaces with clean warm water.</li> <li>➤ Dry glass and clear items immediately to avoid spots.</li> </ul>

\* Cleaner is available for order through your manufacturer. Please contact them, using the information on the front cover of your Owner's Manual.

## HOW TO REMOVE ODORS FROM REFRIGERATOR

1. Remove all food.
2. Disconnect refrigerator.
3. Clean the following items using the appropriate instructions in the Care and Cleaning table.
  - Walls, floor and ceiling of cabinet interior
  - Drawers, shelves and gaskets according to the instructions in this section.
4. Pay special attention to clean all crevices by completing the following steps.
  - Dilute mild detergent and brush solution into crevices using a plastic bristle brush.
  - Let stand for 5 minutes.
  - Rinse surfaces with warm water. Dry surfaces with a soft, clean cloth.
5. Wash and dry all bottles, containers and jars. Discard spoiled or expired items.
6. Wrap or store odor-causing foods in tightly sealed containers to prevent reoccurring odors.
7. Connect power to refrigerator and return food to refrigerator.
8. After 24 hours, check if odor has been eliminated.

### If odor is still present:

1. Remove drawers and place on top shelf of refrigerator.
2. Pack refrigerator and freezer sections – including doors – with crumpled sheets of black and white newspaper.
3. Place charcoal briquettes randomly on crumpled newspaper in both freezer and refrigerator compartments.
4. Close doors and let stand 24-48 hours.

## ENERGY SAVING IDEAS

- Avoid overcrowding refrigerator shelves. This reduces air circulation around food and causes refrigerator to run longer.
- Avoid adding too much warm food to refrigerator at one time. This overloads compartments and slows rate of cooling.
- Do not use aluminum foil, wax paper, or paper toweling as shelf liners. This decreases air flow and causes refrigerator to run less efficiently.
- A freezer that is  $\frac{2}{3}$  full runs most efficiently.
- Locate refrigerator in coolest part of room. Avoid areas of direct sunlight, or near heating ducts, registers or other heat producing appliances. If this is not possible, isolate exterior by using a section of cabinet or an added layer of insulation.
- Refer to section on temperature controls for recommended control settings.
- Clean door gaskets every three months according to cleaning instructions. This will assure that door seals properly and refrigerator runs efficiently.
- Take time to organize items in refrigerator to reduce time that door is open.
- Be sure your doors are closing securely by leveling refrigerator as instructed in your installation instructions.
- Clean condenser coils as indicated in the cleaning instructions every 3 months. This will increase energy efficiency and cooling performance.

## HOW TO REMOVE AND REPLACE LIGHT BULBS

### ⚠ WARNING

To avoid electrical shock which can cause severe personal injury or death, disconnect power to refrigerator before replacing light bulb. After replacing light bulb, connect power.

### ⚠ CAUTION

To avoid personal injury or property damage, observe the following:

- Allow light bulb to cool.
- Wear gloves when replacing light bulb.

### Fresh Food Section

1. Slide shield toward back of compartment to release from light assembly. 
2. Remove light bulbs.
3. Replace with appliance bulbs **no greater than 40 watts**.
4. Replace light bulb cover by inserting tabs on light shield into liner holes on each side of light assembly. Slide shield toward front of refrigerator until it locks into place. **DO NOT** force shield beyond locking point. Doing so may damage light shield.

### Freezer

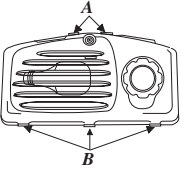
1. Pinch rear tabs on light cover and pull straight down. 
2. Remove light bulb.
3. Replace bulb with appliance bulb **no greater than 40 watts**.
4. Insert front tabs of light cover into freezer liner and snap rear portion over light assembly until rear tabs engage.

# TROUBLE SHOOTING

Today's refrigerators have new features and are more energy efficient. Foam insulation is very energy efficient and has excellent insulating capabilities, however, foam insulation is not as sound absorbent. As a result, certain sounds may be unfamiliar. In time, these sounds will become familiar. Please refer to this information before calling service.

TOPIC	POSSIBLE CAUSE	SOLUTION
Clicking	➤ Freezer control (A) clicks when starting or stopping compressor.	➤ Normal operation
	➤ Defrost timer (B) sounds like an electric clock and snaps in and out of defrost cycle.	➤ Normal operation
Air rushing or whirring	➤ Freezer fan (C) and condenser fan (D) make this noise while operating.	➤ Normal operation
Gurgling or boiling sound	➤ Evaporator (E) and heat exchanger (F) refrigerant makes this noise when flowing.	➤ Normal operation
Thumping	➤ Ice cubes from ice maker (select models) drop into ice bucket (G).	➤ Normal operation
Vibrating noise	➤ Compressor (H) makes a pulsating sound while running.	➤ Normal operation
	➤ Refrigerator is not level.	➤ See Installation Instructions for details on how to level your refrigerator.
Buzzing	➤ Ice maker water valve (I) hookup (select models) buzzes when ice maker fills with water.	➤ Normal operation
Humming	➤ Ice maker (J) is in the 'on' position without water connection.	➤ Stop sound by raising ice maker arm to 'off' position. See <i>Automatic Ice Maker</i> section in your Owner's Manual for details.
	➤ Compressor (H) can make a high-pitched hum while operating.	➤ Normal operation
Hissing or popping	➤ Defrost heater (K) hisses, sizzles or pops when operational.	➤ Normal operation

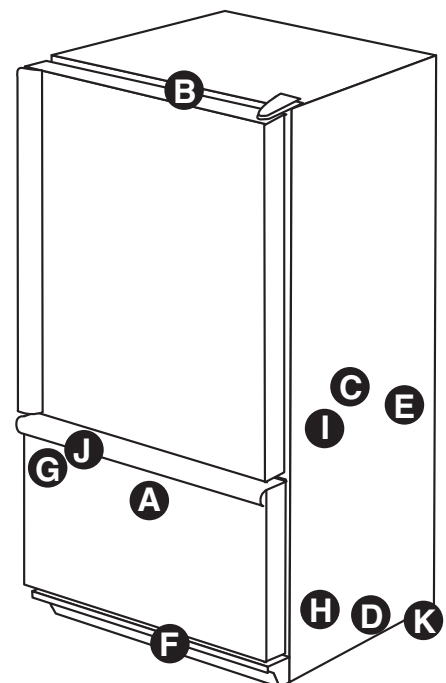

# OPERATION

PROBLEM	POSSIBLE CAUSES	WHAT TO DO
<b>Freezer control and lights are on, but compressor is not operating</b>	Refrigerator is in defrost mode.	Normal operation. Wait 40 minutes to see if refrigerator restarts.
<b>Crisper drawer temperature is too warm</b>	Control settings are too low.	See section on Crisper drawer to adjust controls.
	Freezer controls are set too low.	See controls section in Owner's Manual on how to adjust your controls.
	Drawer is improperly positioned.	See section on Crisper drawer to verify drawer positioning.
<b>Refrigerator does not operate</b>	Refrigerator is not plugged in.	Plug in refrigerator.
	Freezer control is not on.	See controls section in Owner's Manual.
	Fuse is blown, or circuit breaker needs to be reset.	Replace any blown fuses. Check circuit breaker and reset, if necessary.
	Power outage has occurred.	Call local power company listing to report outage.
<b>Refrigerator still won't operate</b>	Refrigerator is malfunctioning.	Unplug refrigerator and transfer food to another refrigerator. If another refrigerator is not available, place dry ice in freezer section to preserve food. Warranty does not cover food loss. Contact service for assistance.
<b>Food temperature is too cold</b>	Condenser coils are dirty.	Clean according to your Owner's Manual.
	Refrigerator or freezer controls are set too high.	See controls section in Owner's Manual on how to adjust controls.
<b>Food temperature is too warm</b>	Door is not closing properly.	Refrigerator is not level. See How to Level Your Refrigerator for details on how to level your refrigerator.
		Check gaskets for proper seal. Clean, if necessary, according to cleaning instructions in Owner's Manual.
		Check for internal obstructions that are keeping door from closing properly (i.e. improperly closed drawers, ice buckets, oversized or improperly stored containers or foodstuffs, etc.)
	Controls need to be adjusted.	See the controls section in Owner's Manual for assistance on how to adjust your controls.
	Condenser coils are dirty.	Clean according to cleaning instructions in Owner's Manual.
	Rear air grille is blocked.	Check the positioning of food items in refrigerator to make sure grille is not blocked. Rear air grilles are located under crisper drawers.
	Door has been opened frequently, or has been opened for long periods of time.	Reduce time door is open. Organize food items efficiently to assure door is open for as short a time as possible.
	Food has recently been added.	Allow time for recently added food to reach refrigerator or freezer temperature.
<b>Refrigerator has an odor</b>	Compartment is dirty or has odor-causing food.	Refer to Care and Cleaning in Owner's Manual for odor removal instructions.
<b>Water droplets form on outside of refrigerator</b>	Check gaskets for proper seal.	Clean, if necessary, according to cleaning instructions in Owner's Manual.
	Humidity levels are high.	Normal during times of high humidity.
	Controls require adjustment.	See the controls section in Owner's Manual for assistance on how to adjust your controls.
<b>Water droplets form on inside of refrigerator</b>	Humidity levels are high or door has been opened frequently.	See the controls section in Owner's Manual for assistance on how to adjust your controls.
	Check gaskets for proper seal.	Reduce time door is open. Organize food items efficiently to assure door is open for as short a time as possible. Clean, if necessary, according to cleaning instructions in Owner's Manual.
<b>Refrigerator or ice maker makes unfamiliar sounds or seems too loud</b>	Normal operation.	Refer to noise section of Normal Operating Sounds guide in Owner's Manual.

# TROUBLE SHOOTING, CONT.

PROBLEM	POSSIBLE CAUSES	WHAT TO DO
Crisper drawers do not close freely	Contents of drawer, or positioning of items in the surrounding compartment could be obstructing drawer.	Reposition food items and containers to avoid interference with the drawers.
	Drawer is not in proper position.	See Crisper drawer section for proper placement.
	Refrigerator is not level.	See How to Level Your Refrigerator for details on how to level your refrigerator.
	Drawer channels are dirty or need treatment.	Clean drawer channels with warm, soapy water. Rinse and dry thoroughly. Apply a thin layer of petroleum jelly to drawer channels.
Refrigerator runs too frequently	Doors have been opened frequently or for long periods of time.	Reduce time door is open. Organize food items efficiently to assure door is open for as short a time as possible. Allow interior environment to adjust for period the door has been opened.
	Humidity or heat in surrounding area is high.	Normal operation.
	Food has recently been added.	Allow time for recently added food to reach refrigerator or freezer temperature.
	Refrigerator is exposed to heat by environment or by appliances nearby.	Evaluate your refrigerator's environment. Refrigerator may need to be moved to run more efficiently.
	Condenser coils are dirty.	Clean according to cleaning instructions in your Owner's Manual.
	Controls need to be adjusted.	See controls section in your Owner's Manual for assistance on how to adjust your controls.
	Door is not closing properly.	Refrigerator is not level. See How to Level Your Refrigerator for details on how to level your refrigerator. Check gaskets for proper seal. Clean, if necessary, according to cleaning instructions in Owner's Manual. Check for internal obstructions that are keeping door from closing properly (i.e. improperly closed drawers, ice buckets, oversized or improperly stored containers or foodstuffs, etc.)

## ICE

PROBLEM	POSSIBLE CAUSES	WHAT TO DO
Refrigerator is leaking water	Plastic tubing was used to complete water connection.	The manufacturer recommends using copper tubing for installation. Plastic is less durable and can cause leakage. <b>The manufacturer is not responsible for property damage due to improper installation or water connection.</b>
	Improper water valve was installed.	Check water connection procedure in chapter called Installing Your Refrigerator. Self-piercing and 3/16" saddle valves cause low water pressure and may clog the line over time. <b>The manufacturer is not responsible for property damage due to improper installation or water connection.</b>
Ice forms in inlet tube to ice maker	Water pressure is low.	Water pressure must be between 20 to 100 pounds per square inch to function properly. A minimum pressure of 35 pounds per square inch is recommended for refrigerators with water filters.
	Freezer temperature is too high.	See controls section in chapter called Installing Your Refrigerator on how to adjust your controls. Freezer is recommended to be between 0 to 2° F (-18 to -17° C).
Water flow is slower than normal	Water pressure is low.	Water pressure must be between 20 to 100 pounds per square inch to function properly. A minimum pressure of 35 pounds per square inch is recommended for refrigerators with water filters.
	Improper water valve was installed.	Check water connection procedure in chapter called Installing Your Refrigerator. Self-piercing and 3/16" saddle valves cause low water pressure and may clog the line over time. <b>The manufacturer is not responsible for property damage due to improper installation or water connection.</b>

# WATER FILTER DATA

## SYSTEM SPECIFICATION AND PERFORMANCE DATA SHEET REFRIGERATOR WATER FILTER CARTRIDGE MODEL WF50

### Specifications

Service Flow Rate (maximum)	0.75 GPM (2.83 L/min)
Rated Service Life WF50-NI300 (maximum)	300 gallons/1135 liters
Rated Service Life WF50-WI500 (maximum)	500 gallons/1892 liters
Maximum Operating Temperature	100° F/38° C
Minimum Operating Temperature	33° F/1° C
Minimum Pressure Requirement	35 psi/138 kPa
Maximum Operating Pressure	120 psi/827 kPa

### PERFORMANCE DATA

Substance	Influent Challenge Concentration	Effluent Average	Average % Reduction	Maximum Effluent	Min. Required Reduction	Inlet pH
Lead	0.15 mg/L +/- 10%	0.001 mg/L	99.33%	0.001 mg/L	0.010 mg/L	6.5
Lead	0.15 mg/L +/- 10%	0.002 mg/L	98.66%	0.003 mg/L	0.010 mg/L	8.5
Cyst	Minimum 50,000/L	1count/mL	99.99%	3 count/mL	> 99.95%	NA
Turbidity	11+/-1 NTU	0.12 NTU	98.98%	0.18 NTU	0.5 NTU	NA
Lindane	0.002 mg/L +/- 10%	0.00005 mg/L	97.62%	0.00005 mg/L	0.00002 mg/L	NA
Atrazine	0.009 mg/L +/- 10%	0.0002 mg/L	97.93%	0.0006 mg/L	0.003 mg/L	NA
Chlorine	2.0 mg/L +/- 10%	0.09 mg/L	95.26%	0.17 mg/L	≥75%	NA
Particulate**	at least 10,000 particles/mL	900 count/mL	99.68%	2400 count/mL	≥85%	NA
2,4-D	0.210 mg/L +/- 10%	45.45 ug/L	84.42%	100 ug/L	0.0017 mg/L	NA
Asbestos	10 <sup>7</sup> to 10 <sup>8</sup> fibers/L; fibers greater than 10 micrometers in length	0.16 MFL/mL	99.96%	0.16 MFL/mL	99%	NA

\* Tested using a flow rate of 0.75 GPM (2.83 L/min.) and a maximum pressure of 120 psi (827 kPa) under standard laboratory conditions, however, actual performance may vary. Health Claim Performance tested and certified by NSF International

\*\* Particle size range classification of test. Particles used were 0.5 –1 microns.

## GENERAL USE CONDITIONS

Read this Performance Data Sheet and compare the capabilities of this refrigerator with your actual water treatment needs.

**DO NOT use this product where water is microbiologically unsafe or of unknown quality without adequate disinfection before or after the system. Systems certified for cyst reduction may be used on disinfected water that may contain filterable cysts.**

**Use only with cold water supply. Check for compliance with the state and local laws and regulations.**

The retractable water filtration system uses a WF50 replacement cartridge. Timely replacement of filter cartridge is essential for performance satisfaction from this filtration system. Please refer to the applicable section in this Owner's Manual for general operation, maintenance requirements and trouble shooting.

This system has been tested according to ANSI/NSF 42 and 53 for reduction of the substances listed below. The concentration of the indicated substances in water entering the system was reduced to a concentration less than or equal to the permissible limit for water leaving the system, as specified in ANSI/NSF 42 and 53.



**PentaPure**  
INCORPORATED  
1000 Apollo Road  
Eagan, Minnesota  
U.S.A.  
EPA EST #35917-MN-



Tested and certified by NSF International against ANSI/NSF Standards 42 and 53 in models WI500 and NI300 for the reduction of:

**Standard No. 42: Aesthetic Effects**

Taste and Odor Reduction  
Chlorine Reduction  
Mechanical Filtration Refrigerator  
Particulate Reduction Class 1

**Standard No. 53: Health Effects**

Chemical Reduction Refrigerator  
Lead, Atrazine, Lindane and 2, 4-D Reduction  
Mechanical Filtration Refrigerator  
Cyst, Turbidity and Asbestos Reduction

# WATER FILTER DATA, CONT.

State of California  
Department of Health Services

## Water Treatment Device Certificate Number

01 - 1486

Date Issued: September 21, 2001  
Date Revised: March 20, 2002

---

<u>Trademark/Model Designation</u>	<u>Replacement Elements</u>	<u>Rated Capacity</u>
WF50-WI500	WF50	500 gal
WF50-NI300	WF50	300 gal
WF50-KWI500	46 9005	500 gal
WF50-KNI300	46 9005	300 gal
OWF50-WI500	OWF51	500 gal
OWF50-NI300	OWF51	300 gal

**Manufacturer:** PentaPure Incorporated

---

The water treatment device(s) listed on this certificate have met the testing requirements pursuant to Section 116830 of the Health and Safety Code for the following health related contaminants:

Microbiological Contaminants and Turbidity

Cysts

Organic Contaminants

Atrazine  
Lindane

Inorganic/Radiological Contaminants

Asbestos  
Lead

---

Rated Service Flow: 0.75

---

# NOTES

# AMANA REFRIGERATOR WARRANTY

## First Year

Amana will replace, free of charge, any part which is defective due to workmanship or materials.

## Second through Fifth Year

Amana will replace free of charge, any sealed system component (compressor, condenser, evaporator, drier and interconnecting tubing) and repair any food compartment liner (exclusive of door liner) which is defective due to workmanship or materials.

## Warranty Limitations

- Begins at date of original purchase.
- Excludes original and replacement water or air filter cartridges (if equipped with the filtration system). Original and replacement cartridges are warranted for 30 days, parts only, against defects of material or workmanship.
- Service must be performed by an authorized Amana technician.
- Damage due to shipping and handling is not covered by this warranty.

## Warranty Is Void If

Repairs resulting from the following:

- Serial plate is defaced.
- Product is used on a commercial, rental, or leased basis.
- Product has defect or damage due to product accident, alteration, connection to an improper electrical supply, fire, flood, lightning, or other conditions beyond the control of Amana.
- Product is improperly installed or used.

**IN NO EVENT SHALL AMANA BE LIABLE FOR INCIDENTAL OR CONSEQUENTIAL DAMAGES.**

*This warranty gives you specific legal rights, and you may have others which vary from state to state. For example, some states do not allow the exclusion or limitation of incidental or consequential damages, so this exclusion may not apply to you.*

# OWNER'S RESPONSIBILITY

- Provide proof of purchase (sales receipt).
- Provide normal care and maintenance. Replace owner replaceable items where directions appear in Owner's Manual.
- Make product reasonably accessible for service.
- Pay premium service costs for service outside technician's normal business hours.
- Pay for service calls related to product installation and usage.

## Amana Appliances Factory Service

1-800-628-5782 inside U.S.A.

## To purchase accessories or replacement parts not covered by your product warranty:

Please have your model and serial numbers ready and call our parts specialists at 1-877-232-6771 inside U.S.A. from 7 a.m. to 7 p.m. central time Monday through Friday.

## For more information:

Maytag Appliances  
Attn: Amana CAIR® Center  
P.O. Box 39  
403 West 4th Street North  
Newton, Iowa 50208-0039  
Ph# 1-800-843-0304 in U.S.A.  
1-866-587-2002 au Canada  
Internet: [http:// www.amana.com](http://www.amana.com)