

Contact our experts

support@raynic.com

FCC Statement

Changes or modifications not expressly approved by the party responsible for compliance could void the user's authority to operate the equipment.

This equipment has been tested and found to comply with the limits for a Class B digital device, pursuant to Part 15 of the FCC Rules. These limits are designed to provide reasonable protection against harmful interference in a residential installation. This equipment generates uses and can radiate radio frequency energy and, if not installed and used in accordance with the instructions, may cause harmful interference to radio communications. However, there is no guarantee that interference will not occur in a particular installation. If this equipment does cause harmful interference to radio or television reception, which can be determined by turning the equipment off and on, the user is encouraged to try to correct the interference by one or more of the following measures:

- Reorient or relocate the receiving antenna.
- Increase the separation between the equipment and receiver.
- Connect the equipment into an outlet on a circuit different from that to which the receiver is connected.
- Consult the dealer or an experienced radio/TV technician for help

This device complies with part 15 of the FCC rules. Operation is subject to the following two conditions (1) this device may not cause harmful interference, and (2) this device must accept any interference received, including interference that may cause undesired operation.

CR1002

FM & BLUETOOTH Clock Radio
CREATE A PERFECT SLEEP ENVIRONMENT

<https://www.raynic.com>



Version 1.3

Chapter 1 PRODUCT DIAGRAM

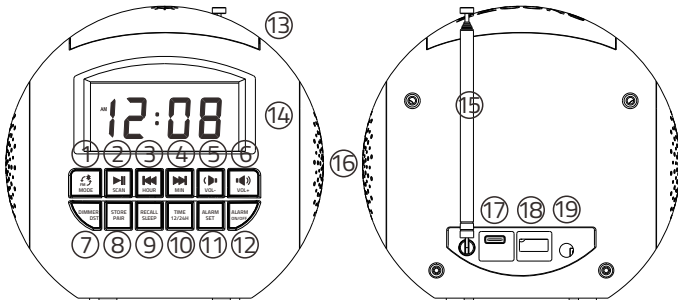

Buttons

1. FM & Bluetooth Mode
2. Play & Scan
3. Previous & Hour
4. Next & Minute
5. Volume Down
6. Volume Up
7. Dimmer & DST
8. Store & Pair
9. Recall & Sleep
10. Time & 12/24H
11. Set Alarm
12. Alarm ON/OFF
13. Snooze & Night Light

Parts

14. Display
15. Radio Antenna
16. Speaker
17. Type C Charging Port
18. USB Charging Port
19. DC IN Port

Chapter 2 OUTLET POWERED & BATTERY BACKUP

1. Pull the insulator out of battery compartment to activate Cr2032 as backup battery.

NOTE: Backup battery(included) doesn't support time display, only support back up Time & Alarm setting.



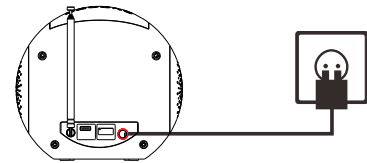





2. Connect the adapter to DC jack , then plug into a 100~240V AC wall power outlet.



Chapter 3 TIME SETTING



1. Press **TIME 12/24H** button once, display **12:00** starts flashing.
2. Press **← HOUR** button to set the hour and press **→ MIN** button to set the minute.
3. Press **TIME 12/24H** button to save time or wait for another 10 seconds to confirm automatically.
4. Hold press **TIME 12/24H** button to change 12H/24H time format.

Chapter 4 ALARM SETTING

1. Press  button, the alarm indicator **ALM** lights up, the display  starts flashing.
2. Press  button to set hour, press  button to set minute.
3. Press  button to save setting or wait for another 10 seconds to confirm automatically.
4. The alarm indicator   flash. Press  or  select to wake up with buzzer or FM radio.
5. Press  or wait for 10 seconds to save alarm setting.



NOTE: If you select wake up to FM Radio, Radio channel you listened last time will be the default radio alarm.

In standby mode

Press  and  button to adjust the volume alarm ring of your preference.

Press  to turn on or turn off the most recent alarm.





When alarm goes off

1. Alarm will ring every next 9 minutes.
2. Press  to turn off the alarm for 24 hours, the alarm indicator Still be on, alarm will be activated again after 24 hours.
3. To completely turn off the alarm, double press  , the indicator will turn off.





- 03 -

Chapter 6 BLUETOOTH

CONNECTING & DISCONNECTING

1. Repeat  button until it's in Bluetooth mode.
2. Once in Bluetooth mode the  indicator will flash while searching for the last connected device.
3. If the Last connected device is not found, the CR1002 will search for another available device.
4. Select CR1002 from the Bluetooth list on your device to start pairing.
5. Once pairing is successful, the  indicator will stop flashing and a beep will sound for speaker.
6. Press  button to disconnect your device from CR1002. A beep sound to confirm the device has been disconnected successfully. CR1002 will now be in pairing mode again, allowing you to pair a new device.















PLAY OPERATION

1. Repeat  or  button to adjust the volume.
2. Press  button to play or pause the music.
3. Press  button to play previous music, press  button to play the next music.

Chapter 7 SLEEP TIMER SETTING



In Bluetooth mode or FM mode, hold press  button to set the sleep timer, fall asleep with the radio by presetting it to play for a certain amount of time.

Chapter 5 FM RADIO

1. Repeat  button until indicator **FM** light up which means FM radio is turned on.
2. Manual Tuning Radio Channel
Repeat  or  button to tune into the desired channel.
3. Auto Scanning Radio Channel.
Press  button to start auto channel scanning, radio will store available channel to P01, P02, P03.....P20.
4. Manual Store Radio Channel
Select the radio channel which you desire, press  button, display will show <P+number>, such as P05, press  or  to select new <P+number> such as P06, then press  directly channel, the channel will be stored.
5. Preset Channel Recall
Press  button to switch preset channel, then press  or  button to select the channel which you desire, such as P03 then press  button, radio will confirm your selection.
6. Adjust Radio Volume
Repeat  or  button to adjust the FM radio volume.

- 04 -



Chapter 8 DST SWITCH

1. Hold press  Button to add an hour to the current time on the display, the  indicator will light up .
2. To turn off DST, hold press  button again, the indicator will disappear from the display and the current time will be cut down one hour.

Chapter 9 DIMMER

Repeatedly press  button to adjust the brightness of display to your preference.

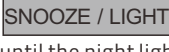
Chapter 10 NIGHT LIGHT

1. Turn on NIGHT LIGHT
Press  button then the night light will turn on.
2. Turn off NIGHT LIGHT
Long press  button for 2 seconds or press it repeatedly until the night light turns off.
3. Switch NIGHT LIGHT Color
When the night light turns on, you can press  button to switch to the color as you desired.
The night light colors are as below: Oyster White, Cobalt Blue, Sky Blue, Green, Sunrise Orange, Shocking Pink, Violet.

Chapter 11 USB CHARGING

Plug charging cable into device such as phone or tablet.

Then clock can charge your phone or tablet .

The maximum charge current is 1 Ampere.

- 06 -