

Owner Instructions



Warning!

Read instructions before using the machine



HWV 370



Henry WASH



www.numatic.co.uk



MADE IN THE
UNITED
KINGDOM
Since 1969

Please refer to information for wet vacuum cleaners BEFORE use at rear of manual.

Kit AH-6



Filling your machine



Carpet Cleaning Assembly

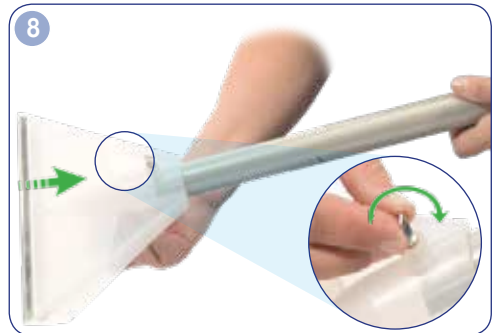
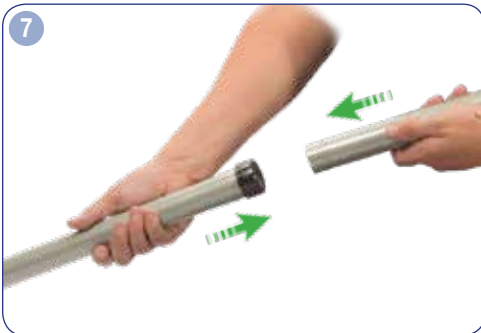
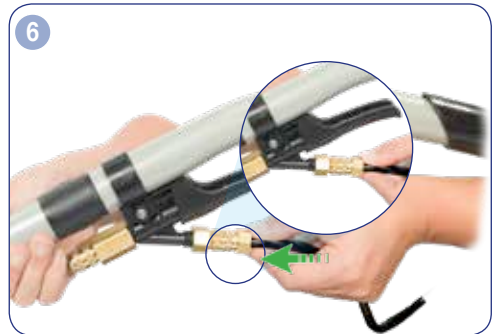
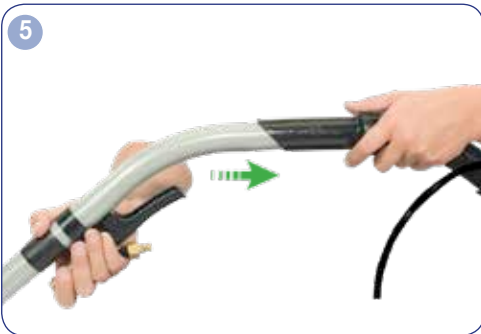

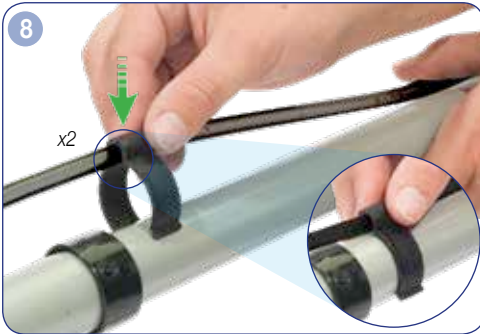
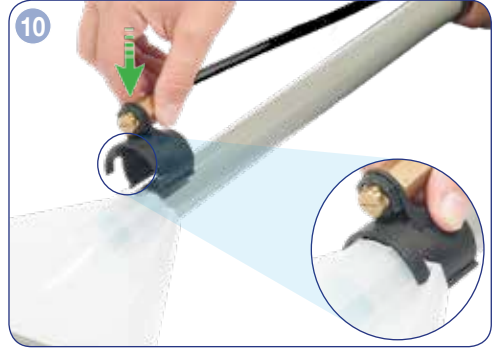

NuChem 4

INSTRUCTIONS FOR USE TEST FOR COLOUR FASTNESS

Find a small area on the material which is not normally on view and test the carpet / fabric for colour fastness by rubbing with a cloth dampened with correctly diluted NuChem 4.

Do not use on velvet type materials or any materials not suitable for wet cleaning according to fabric manufacturers cleaning instructions.

For Normal soiling: Pour one 40ml Measure into 5 litres of cold water.

For Heavy Soiling: Pour two 40ml Measure into 5 litres of cold water.

NuChem 4 is non-foaming, bactericidal, contains optical brighteners and leaves no tacky residues in the fabric and is enhanced with both a delicate and discreet verbena scent.

P102: Keep out of reach of children.
P305+351+338:

IF IN EYES:
Rinse continuously with water for several minutes.
Remove contact lenses, if present and easy to do.
Continue rinsing.



CONTENTS:

Composition:
Greater than 30% = among other ingredients water

Less than 5% = SODIUM XYLENE SULPHONATE
CAC: 1300-72-7
Anionic Surfactants
Non-ionic Surfactants

Contains: Optical brightner
Preservative: Methylisothiazoline,
Methylchloroisothiazolinone

Using your machine (Carpet Cleaning)

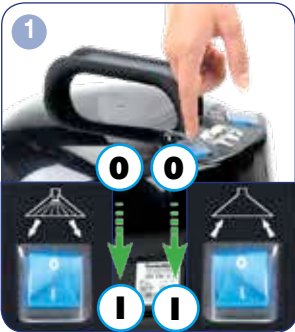
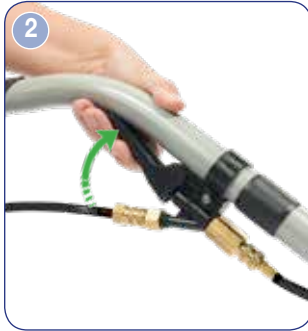

Hard Floor Assembly

Assemble machine steps 1-5 (Page 3)

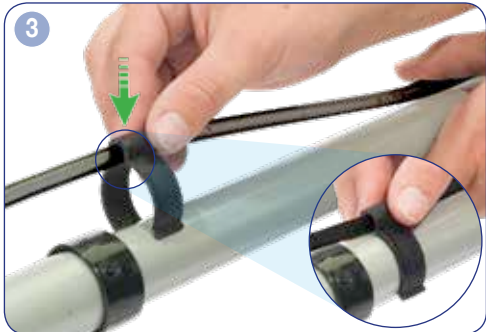

Using your machine (Hard Floor Cleaning)

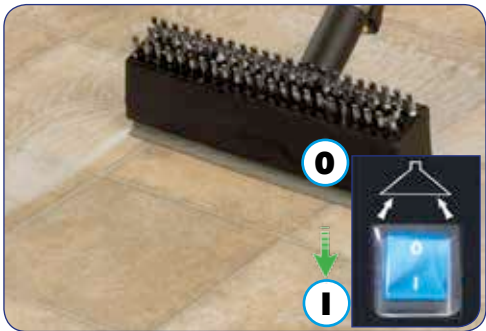
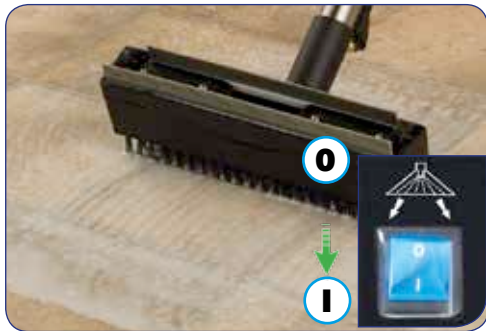

Upholstery Cleaning Assembly

Assemble machine steps 1-4 (Page 3)



Using your machine (Upholstery Cleaning)



Cleaning the machine

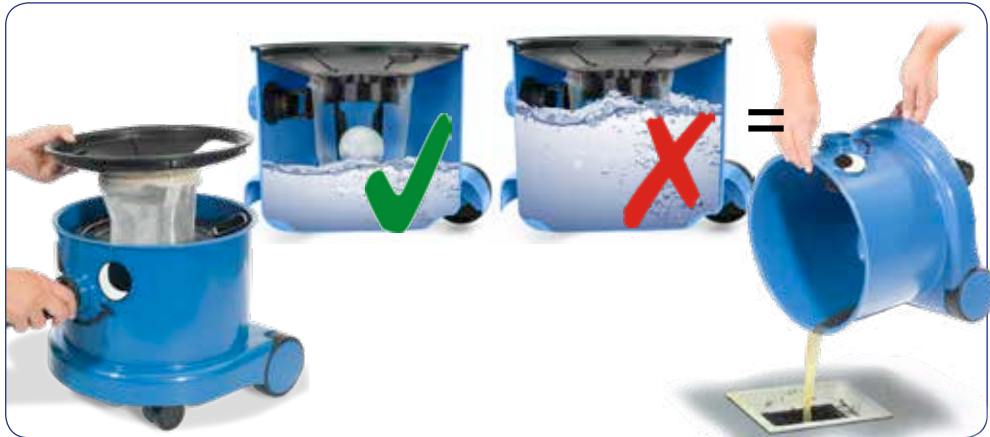

Fitting the face



Removing the face



Carrying your Henry Wash & cable storage



Schematic diagram

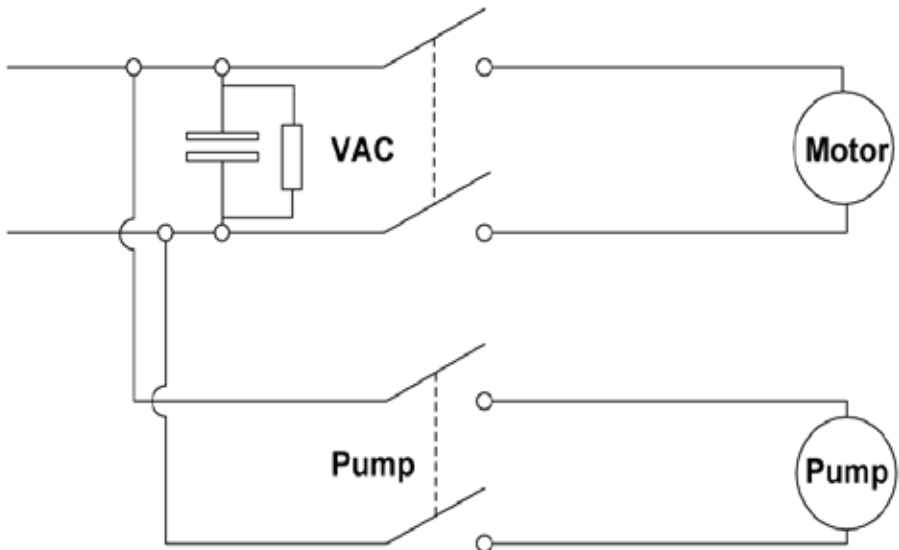

- 1 Voltage
- 2 Frequency
- 3 Rated Input Power
- 4 Weight (ready to work)
- 5 Company Name & Address
- 6 Model
- 7 Machine yr/wk Serial number
- 8 WEEE Logo
- 9 Protection Class 2 Symbol
- 10 CE Mark

Rating Label

- 11 MAX pressure
- 12 Splash proof rating

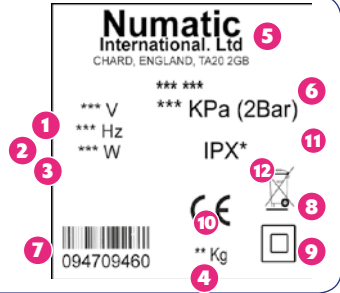

PPE (personal protective equipment) That may be required for certain operations.

Ear Protection	Safety Footwear	Head Protection	Safety Gloves	
Eye Protection	Protective Clothing	Dust / Allergens Protection	hi Vis Jacket	Caution Floor Sign

NOTE: A risk assessment should be conducted to determine which PPE should be worn.

Safety Critical Components

Mains leads:

HO5-VV-F 10 x 2 x 1.00 mm²

WEEE Legislation

(Waste, Electrical and Electronic Equipment)

Vacuum cleaner, accessories and packaging should be sorted for environmentally - friendly recycling.

(Only for EU Countries)

Do not dispose of vacuum cleaner into household waste! According to the European Directive 2012/19/ EU on waste electrical and electronic equipment and its incorporation into national law.

Vacuum cleaners that are no longer suitable for use must be separately collected and sent for recovery in an environmentally - friendly manner.



Failure to rectify the problem or in the event of a breakdown contact your Numatic dealer or the Numatic Technical helpline +44 (0)1460 269268.

Motor	AirFlo	Suction	Cleaning Range	Class	
1060W	49 L/sec	2400mm	26 m	II	
Sound Pressure		Solution Tank	Size	Capacity	Weight Ready to use
78.7 dB (Wet) (IEC 60704-2-1) Uncertainty: 0.2 dB (A)		5 Litres	360x370x510	9 Litres	15.3 Kg

Warning!

Read the instruction manual before using the machine.

Operators shall be adequately instructed on the use of these machines.

As with all electrical equipment, care and attention must be exercised at all times during use, in addition to ensuring that routine and preventative maintenance is carried out periodically to ensure safe operation.

Failure to carry out maintenance as necessary, including the replacement of parts to the correct standard could render this equipment unsafe and the manufacturer can accept no responsibility in this respect.

The machine shall be disconnected from the mains by removing the plug from the supply socket during cleaning or maintenance and when replacing parts or converting the machine to another function.

The machine is not to be used by children or persons with reduced physical, sensory or mental capabilities, or lack of experience or knowledge, unless they have been given supervision or instruction.

Children being supervised are NOT to play with the machine.

This appliance is intended to be assembled, cleaned and maintained by an adult.

This machine is not a toy.

Caution

If foam/liquid comes out of machine exhaust, switch off immediately.

Allow the accumulated liquid to drain out through the machine exhaust, check the float assembly to ensure correct operation, empty the container if full of liquid, reassemble the machine.

Immediately upon start up there will be a certain amount of liquid issuing from the machine exhaust which will be the residue of liquid still within the power head. This will be quickly discharged after which the machine should function normally.

Liquid ejected from the machine could be hazardous as a result of its temperature, pressure or chemical content.

This machine is not suitable for the collection of biological hazards, hazardous or explosive dust. You should contact your local distributor if you require a machine capable of performing these tasks.

Ensure that the filtration system fitted to the machine is suitable for the material being collected.

This machine is for indoor use only.

This machine shall be stored indoors only. .

When moving from one place to another, consider the weight of the machine.

Notes

You must ensure that the filtration system fitted to the machine is suitable for the material being collected.

This product complies with the requirements of IEC/EN 60335-2-68.

This product complies with the requirements of IEC/EN 60335-2-69.

The primary use for this machine is commercial, for example in hotels, schools, hospitals, factories, shops and offices.

If the vacuum cleaner stops working, remove the plug from the wall before investigating where the fault lies.

If the vacuum cleaner has a blockage, switch off, remove the plug from the socket outlet, and inspect the floor tool, wands and hose for debris.

The vacuum cleaner should be inspected after use for damage.

The power light will illuminate, when your machine is connected to a suitable power supply (where fitted).

Do

- *Make sure you DRY vacuum the carpet before washing.*
- *Keep your machine clean.*
- *Keep filters clean.*
- *Regularly clean the water level limiting float safety valve and examine for signs of damage or correct operation.*
- *Keep hoses and tubes clear.*
- *Replace any worn or damaged parts immediately.*
- *Regularly examine the power cord, if damage is found, power cord must be replaced by a qualified person using the correct Numatic original part.*
- *Keep diffuser filter (where fitted) clean.*

Don't

- *Use steam cleaners or pressure washers to clean the machine or use the machine in the rain.*
- *Immerse in water for cleaning.*
- *Allow any inexperienced repairs. Call the experts.*
- *Use wet if float valve is not functioning or fitted.*
- *Use to suck up hot ashes, or lighted cigarette ends.*
- *Run the machine over the power cable during operation as a hazard may occur.*
- *Pull on the cable to unplug the machine from the power supply.*
- *Walk over-wet carpets, upholstery or fabrics.*
- *Walk on clean carpets until fully dry.*
- *Spray onto people or animals.*
- *Attempt machine maintenance or cleaning unless the power supply plug has been removed from the supply outlet.*

Fault Finding

This machine can be used for wet pick up and cleaning carpet and upholstery

Spray extraction machines only

- *Use only approved cleaning preparations.*
- *Use defoamer if necessary.*

Use of detergents

When using any detergent with this machine, please ensure you have read the safety data on the container and you are familiar with the procedures to clear up spills, inhalation, skin and eye contact.

Wet mode / Spray extraction maintenance/fault finding

If the vacuum cleaner stops working switch off and remove the plug from the wall before investigating were the fault lies.

If the vacuum cleaner has a blockage and will not pick up liquid, switch off and remove the plug from the wall, has the float valve operated, this will shut off the suction and the pitch of the vacuum motor will change. Remove the power head and empty the liquid out of the container, if the container is empty, check that the floor tool wands and hose are not blocked.

If the spray nozzle is blocked a pin maybe used to clear the blockage.

No spray from nozzle and the pump tone changes, the solution tank is empty, refill the solution tank.

Flush the system with clean water after use.

After use always inspect the machine for damage.



**EU DECLARATION
OF
CONFORMITY**

We hereby declare under our sole responsibility that the following equipment fulfils all the relevant provisions of the following EU Directives

Machinery Directive 2006/42/EC
EMC Directive 2014/30/EU
RoHS Directive 2011/65/EU

Machine Description: Vacuum Cleaner
Machine Type: GVE, CT, CTT, HVW Series.

Relevant standards upon which conformity is declared include:

EN 60335-1: 2012 + AC:2014 + A11:2014
EN 60335-2-69: 2012
EN 60335-2-68: 2012
EN 55014-1: 2006 + A1:2009 + A2:2011
EN 55014-2: 1997 +A1:2001 + A2:2008
EN 62233: 2008

A technical construction file for this equipment is retained at the manufacturer's address under the authorisation of the following signatory:

Name: Allyn Boyes Position: Development Manager

Signed

Date

2/11/17



Numatic International Ltd
Chard Somerset
TA20 2GB
www.numatic.co.uk

GB

Daily

Keep the machine clean, including hoses and tubes.
Regularly examine the power cord.

Weekly - as daily and:-

Check for any worn or damaged parts and replace immediately.
Do not steam clean or pressure wash.

Numatic International Warranty

Numatic International Limited warrant to the original purchaser that its products are free of defects in both material or workmanship for the period shown below:-

Homecare and Cleancare Vacuum cleaners.....	2 Years
Rotary Floor Machines.....	2 Years
Twintec Auto Scrubber Dryer.....	1 Year
Vario Ride-On Scrubber Dryer.....	1 Year / 1500 hours
Mopping, Compacts, Combi and Servocare Products.....	1 Year
Individual Accessories and Spare Parts.....	6 Months

Note: This warranty expressly excludes consumable parts such as carbon brushes, floor brushes, mops, batteries etc, that are considered replaceable from time to time during the normal working life of the machine.

Using non Numatic dustbags can be detrimental to both machine performance and life and may invalidate the Warranty.

- A. The warranty period commences from the date the goods are purchased.*
- B. All warranty claims must be processed through the Dealer from whom the equipment was purchased. The Dealer will co-operate with the purchaser throughout the warranty claims procedure and will arrange any necessary repairs using genuine Numatic parts.*
- C. If the original Dealer is no longer able to fulfil his obligations please contact Numatic International Limited with full details of the claim and proof of purchase so that this may be processed without delay.*
- D. Any warranty claim can only relate to the specific part that is proven to be at fault and for which a replacement will be supplied but cannot be extended to constitute a claim against the complete machine.*
- E. Numatic International will supply the Dealer with any warranty parts required, subject to the claim being validated, after return of the faulty items in accordance with Numatic International Limited's General Conditions of Sale.*
- F. Claims will not be accepted if they are the result of fair wear and tear, misuse or abuse of any kind.*
- G. No replacement will be given unless the appropriate evidence of the validity of the claim has been provided to the satisfaction of Numatic International Limited.*
- H. Numatic International Limited reserve the right to charge for any unnecessary work carried out as a result of an invalid claim.*
- I. No variation to this warranty may be made or implied by any member of Numatic International Limited or its Dealers unless such variation is in writing and authorised by the Company*



Numatic International Limited. Chard, Somerset, TA20 2GB

Telephone: 01460 68600 Fax: 01460 68458

© Numatic International Limited

umatic
INTERNATIONAL



Numatic
INTERNATIONAL



Numatic International Limited, Chard, Somerset, TA20 2GB
Telephone: 01460 68600
Fax: 01460 68458

UNITED KINGDOM: www.numatic.co.uk

GERMANY: www.numatic.de

SWITZERLAND: www.numatic.ch

FRANCE: www.numatic.fr

NETHERLANDS: www.numatic.nl

SOUTH AFRICA: www.numatic.co.za

PORTUGAL: www.numatic.pt

Specification subject to change without prior notice

www.numatic.com © Numatic International Limited

907218 11/17 (A01)