



User Manual

Upright Fridge

HRF505VW

HRF505VS

EN

Haier



Thank you for purchasing a Haier Product.

Please read these instructions carefully before using this appliance. The instructions contain important information which will help you get the best out of the appliance and ensure safe and proper installation, use and maintenance.

Keep this manual in a convenient place so you can always refer to it for the safe and proper use of the appliance.

If you sell the appliance, give it away, or leave it behind when you move house, make sure you also pass on this manual so that the new owner can become familiar with the appliance and safety warnings.

WARNING: Risk of fire/flammable material. The symbol indicates there is a risk of fire since flammable materials are used. Take care to avoid causing a fire by igniting flammable material.



Manufacturer: Qingdao Haier Special Icebox Co., Ltd.

Address : Haier Garden, Qianwangang Road, Economic
Development Zone, Qingdao 266555, Shandong, P.R.China

www.haier.com.au

www.haier.co.nz

1 - Safety	4
2 - Intended Use.....	11
3 - Product Description.....	12
4 - Use.....	13
5- Equipment	17
6 - Care and Cleaning.....	18
7 - Troubleshooting.....	20
8 - Installation	23
9 - Technical Data	27

Before switching on the appliance for the first time, read the following safety hints!



WARNING!

Before first use

- ▶ Make sure there is no transport damage.
- ▶ Remove all packaging and keep out of children's reach.
- ▶ Wait at least 2 hours before installing the appliance in order to ensure the refrigerant circuit is fully efficient.
- ▶ Handle the appliance always with at least two persons because it is heavy.

Installation

- ▶ The appliance should be placed in a well-ventilated place. Ensure a space of at least 5 cm above and around the appliance.
- ▶ **WARNING:** Keep ventilation openings in the appliance or in the in-built structure clear of obstruction.
- ▶ Never place the appliance in a damp area or location where it might be splashed with water. Clean and dry water splashes and stains with a soft clean cloth.
- ▶ Do not install the appliance in direct sunlight or in the near of heat sources (e.g. stoves, heaters).
- ▶ Install and level the appliance in an area suitable for its size and use.
- ▶ Make sure that the electrical information on the rating plate agrees with the power supply. If it does not, contact an electrician. The appliance is operated by a 220-240 VAC/50 Hz power supply.
- ▶ Abnormal voltage fluctuation may cause the appliance to fail to start, or damage to the temperature control or compressor, or there may be an abnormal noise when operating. In such case, an automatic regulator shall be mounted.
- ▶ Do not use multi-plug adapters and extension cables.
- ▶ **WARNING:** Do not locate multiple portable socket outlets or portable power supplies at the rear of the appliance.
- ▶ **WARNING:** When positioning the appliance, ensure the supply cord is not trapped or damaged.
- ▶ Do not step on the power cable.
- ▶ Ensure that the power cable is not trapped by the fridge.
- ▶ Do not cover air vent openings.
- ▶ Use a separate earthed socket for the power supply which is easily accessible. The appliance must be earthed.

 **WARNING!**

- ▶ **WARNING:** Do not damage the refrigerant circuit.

Daily use

- ▶ This appliance can be used by children aged from 8 years and above and persons with reduced physical, sensory or mental capabilities or lack of experience and knowledge if they have been given supervision or instruction concerning use of the appliance in a safe way and understand the hazards involved.
- ▶ Children shall not play with the appliance.
- ▶ Children aged from 3 to 8 years are allowed to load and unload refrigerating appliances, but not allowed to clean and install the refrigerating appliances.
- ▶ Keep away children under 3 years of age from the appliance unless they are constantly supervised.
- ▶ Cleaning and user maintenance shall not be made by children without supervision.
- ▶ The appliance must be positioned so that the plug is accessible.
- ▶ If coal gas or other inflammable gas is leaking into vicinity of the appliance, turn off the valve of the leaking gas, open the doors and windows and do not unplug or plug in the power cable of the fridge or any other appliance.
- ▶ Notice that the appliance is set for operation at the specific ambient range between 10 °C and 43°C. The appliance may not work properly if it is left for a long period at a temperature above or below the indicated range.
- ▶ Do not place unstable articles (heavy objects, containers filled with water) on top of the fridge, to avoid personal injury caused by falling or electric shock caused by contact with water.
- ▶ Do not store or use inflammable, explosive or corrosive materials in the appliance or in the vicinity.
- ▶ Do not lift the appliance by its handles.
- ▶ Never place the appliance horizontally on the ground when moving it.
- ▶ Before any operation, first unplug the appliance from the mains.
- ▶ Do not tilt the appliance more than 45 ° to prevent damage of the cooling system when moving the appliance.
- ▶ Unplug the appliance in the event of a power interruption or before cleaning. Allow at least 7 minutes before restarting the appliance, as frequent starting may damage the compressor.
- ▶ Check the condition of food if a warming in the fridge has taken place.



WARNING!

- ▶ Do not pull on the door shelves. The door may be pulled slant, the door shelves, may be pulled away, or the appliance may topple.
- ▶ Open and close the door only with the handles. The gap between the door and the cabinet is very narrow. Do not put your hands in these areas to avoid pinching your fingers. Open or close the appliance doors only when there are no children standing within the range of door movement.
- ▶ **WARNING:** Do not use electrical devices inside the food storage compartments of the appliance, unless they are of the type recommended by the manufacturer.
- ▶ **WARNING:** The lamps can only be replaced by manufacturer, together with a part of the appliance.
- ▶ **WARNING:** If you are unsure of the refrigerant type check the rating plate in the unit.
- ▶ It is hazardous for anyone other than an Authorized Service Person to service this appliance.
- ▶ In Queensland – the authorized Service Person **MUST** hold a Gas Work Authorization for hydrocarbon refrigerants, to carry out Servicing or repairs which involve the removal of covers.

**WARNING!****Maintenance / cleaning**

- ▶ Make sure children are supervised if they carry out cleaning and maintenance.
- ▶ Disconnect the appliance from the electrical supply before undertaking any routine maintenance. Allow at least 7 minutes before restarting the appliance, as frequent starting may damage the compressor.
- ▶ Hold the plug, not the cable, when unplugging the appliance.
- ▶ Do not clean the appliance with hard brushes, wire brushes, detergent powder, petrol, amyl acetate, acetone and similar organic solutions, acid or alkaline solutions. Please clean with special fridge detergent to avoid damage.
- ▶ Do not scrape off frost and ice with a sharp objects. Do not use sprays, electric heaters like heater, hair dryer, steam cleaners or other sources of heat in order to avoid damage to the plastic parts.
- ▶ **WARNING:** Do not use mechanical devices or other means to accelerate the defrosting process, other than those recommended by the manufacturer.
- ▶ If the supply cord is damaged, it must be replaced by the manufacturer, its service agent or similarly qualified persons in order to avoid a hazard.
- ▶ Do not try to repair, disassemble or modify the appliance by yourself. In case of repair please contact our customer service.
- ▶ Eliminate the dust on the back of the unit at least once in the year to avoid hazard by fire, as well as increased energy consumption.
- ▶ Do not spray or flush the appliance during cleaning.
- ▶ Do not use water spray or steam to clean the appliance.
- ▶ Do not clean the cold glass shelves or glass door with hot water. Sudden temperature change may cause the glass to break.
- ▶ Disconnect the appliance from the power supply before cleaning.
- ▶ Before maintenance, deactivate the appliance and disconnect the mains plug from the mains socket.
- ▶ Electrical equipment should be serviced only by qualified electrical experts, because improper repairs can cause considerable consequential damages.

Refrigerant gas information



WARNING!

The appliance contains the flammable refrigerant ISOBUTANE (R600a). Make sure the refrigerant circuit is not damaged during transportation or installation. Leaking refrigerant may cause eye injuries or ignite. If a damage has occurred, keep away open fire sources, thoroughly ventilate the room, do not plug or unplug the power cords of the appliance or any other appliance. Inform the customer service.

In case of eyes get into contact with the refrigerant, rinse it immediately under running water and call immediately the eye specialist.

WARNING: The refrigeration system is under high pressure. Do not tamper with it. Since the flammable refrigerants are used, please, install, handle and service the appliance strictly according to the instruction and contact the professional agent or our after-sales service to dispose of the appliance.



WARNING!

- ▶ Taking care to avoid causing a fire by igniting flammable material.
- ▶ **WARNING:** When positioning the appliance, ensure the supply cord is not trapped or damaged.
- ▶ **WARNING:** Do not locate multiple portable socket-outlets or portable power supplies at the rear of the appliance.
- ▶ Do not store explosive substances such as aerosol cans with a flammable propellant in this appliance.
- ▶ For flammable refrigerants is used in the **fridge, please be careful** when installing, handling, serving and recycling the appliance.
- ▶ Please contact to the service agent to dispose the appliance because the flammable blowing gas was used.

Intended use

This appliance is intended to be used in household and similar applications such as

- staff kitchen areas in shops, offices and other working environments;
 - farm houses and by clients in hotels, motels and other residential type environments;
 - bed and breakfast type environments;
 - catering and similar non-retail applications.
- If the appliance is not used for an extended period of time, and you will not use the Holiday function for the fridge;
- Take out the food.
 - Unplug the power cord.
 - Clean the appliance as described above.
 - Keep the doors open to prevent the creation of bad odours inside.
- To ensure the safe preservation of foodstuffs, please comply with this instruction for use.
- The details on the most appropriate part in the compartment of the appliance where specific types of food shall be stored, considering the distribution of temperature that can be present in the different compartments of the appliance are in the other part of the manual.
- To avoid contamination of food, please respect the following instructions:
- Opening the door for long periods can cause a significant increase of the temperature in the compartments of the appliance.
 - Clean regularly surfaces that can come in contact with food and accessible drainage systems.

- If the refrigerating appliance is left empty for long periods, switch off, defrost, clean, dry, and leave the door open to prevent mould developing within the appliance.

Disposal



The  symbol on the product or on its packaging indicates that this product may not be treated as household waste. Instead it shall be handed over to the applicable collection point for the recycling of electrical and electronic equipment. By ensuring this product is disposed of correctly, you will help prevent potential negative consequences for the environment and human health, which could otherwise be caused by inappropriate waste handling of this product. For more detailed information about recycling of this product, please contact your local city office, your household waste disposal service or the shop where you purchased the product.

Since the flammable insulation blowing gases are used, please contact the professional agent or our after-sale service to dispose of the appliance.

WARNING!

Risk of injury of suffocation!

Refrigerants and gases must be disposed of professionally. Ensure that the tubing of the refrigerant circuit is not damaged before being properly disposed of. Disconnect the appliance from the mains supply. Cut off the mains cable and dispose of it. Remove the trays and drawers as well as the door catch and seals to prevent children and pets to get closed in the appliance.

2.1 Intended Use

"This appliance is intended to be used in household and similar applications such as

- staff kitchen areas in shops, offices and other working environments;
- farm houses and by clients in hotels, motels and other residential type environments;
- bed and breakfast type environments;
- catering and similar non-retail applications.

This appliance is intended for storing fresh food. It has been designed exclusively for use in dry interior house-holds. It is not intended for commercial or industrial use.

Changes or modifications to the device are not allowed. Unintended use may cause hazards and loss of warranty claims.

2.2 Accessories

Check the accessories and literature in accordance with this list:

2.2



Warranty card



User manual



Top right trim end cover

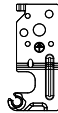

Upper left hinge for door reversibility



Upper left hinge cover

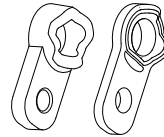

Axe covers



Notice: Differences

Due to technical changes and different models, some of the illustrations in this manual may differ from your model.



1 LED light

2 Air-duct cover

3 Glass shelves

4 Fresh storage bins

5 Adjustable feet

6 Adjustable door shelves

7 Rating plate

8 Door handle

4.1 Before first use

- ▶ Remove all packaging materials, keep them out of children reach and dispose them in an environmentally friendly manner.
- ▶ Clean the inside and outside of the appliance with water and a mild detergent before putting any food in it.
- ▶ After the appliance has been levelled and cleaned, wait for at least 2 hours before connecting it to the power supply. See Section INSTALLATION.
- ▶ Precool the compartment for 2 hours at high settings before loading with food. The function Super Cool helps to cool down the compartment quickly.

4.2 Switching the appliance on /off

The appliance is in operation as soon as it is connected to the power supply.

- ▶ The fridge temperature is automatically set to 4 °C. This is the recommended setting and the ideal temperature for storing fresh goods. If desired, you can change the temperature manually. Please see ADJUSTING THE TEMPERATURE.



Notice: Presettings

1. The appliance is preset to the recommended temperature of 4 °C. Under normal ambient condition you don't need to change the temperature.
2. When the appliance is switched on after being disconnected from the main power supply, it may take up to 12 hours for the correct temperature to be reached.

Empty the appliance before switching off. To switch off the appliance, pull the power cord out of the power socket.

4.3 Standby-mode of display

When the door is closed the display screen turns off automatically 30 seconds after without operation. The display locks automatically. It lights up automatically when pressing any key or opening the door.

4.4 Control panel (Fig. 4)

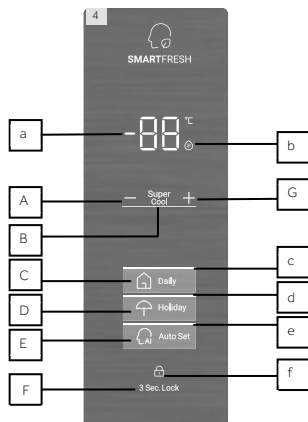
**Display description**

- a: Temperature display icon
- b: Super Cool icon
- c: Daily function icon
- d: Holiday icon
- e: Auto Set icon
- f: Lock icon

Key Description

- A: Decreasing temperature setting key: Press to decrease the temperature
- B: Super Cool key: Press to enter the Super Cool mode
- C: Daily function key: Press to enter Daily mode
- D: Holiday key: Press to enter Holiday mode
- E: Auto Set key: Press to enter Auto Set mode
- F: Lock key: Press and hold for 3 seconds to lock or unlock
- G: Increasing temperature setting key: Press to increase the temperature

4.5 Display lock and unlock

Automatic locking

The display panel can automatically enter the Lock function. Display is automatically locked after 30 seconds without operation.

Manual locking

When the display is unlocked, press "Lock"(F) and hold for 3 seconds, after a beep, "Lock" (f) icon is light, display is locked. When the display is locked, press "Lock "(F) and hold for 3 seconds, after a beep, "Lock " icon (f) is off, and the display is unlocked.

**Notice: Display lock**

When display is locked, functions such as temperature adjustment or function setting are disabled. When above operation is attempted, Lock icon will blink for 3 times to remind that the display is locked.

4.6 Temperature setting

The temperature range of this fridge can be set between 2 °C ~ 8 °C .

When display is unlocked, under daily function, press "Decreasing temperature setting" (A), after a beep, "Temperature display icon" (a) starts to flash and the display enters temperature setting mode. And then every time you press "Decreasing temperature setting" (A), the buzzer beeps and the temperature lowers by 1°C, and the minimum temperature is 2°C. When the temperature is set, the "Temperature display icon"(a) will stop flashing after 5 seconds without operation.

When display is unlocked, under daily function, press "Increasing temperature setting" (G), after a beep, the "Temperature display icon" (a) starts to flash and the display enters the temperature setting mode, and then every time you press "Increasing temperature setting" (G), the buzzer beeps, the temperature increases by 1°C, and the maximum temperature is 8°C. When the temperature is set, the "Temperature display" icon(a) will stop flashing after 5 seconds without operation.

4.7 Daily function (C)

The appliance is under the Daily function as soon as it is connected to the power supply for the first time, and the "Daily" icon (c) lights up. Only under this function, the temperature can be adjusted and set.

4.8 Super Cool function (B)

When display is unlocked, by touching "Super Cool" (B), SuperCool icon (b) will be light, the fridge works in Super Cool mode. To exit Super Cool function manually, repeat steps above. If not exit manually, the function will exit automatically after 3 hours.



Notice: Super Cool

1. In Super Cool mode, temperature could not be adjusted. If you do so, Super Cool icon will flash for 3 times to remind that the fridge is in Super Cool mode.
2. In Super Cool mode, if the Auto Set function or Holiday is set, Super Cool icon (b) is off, the Super Cool function automatically exits, and Auto Set or Holiday function is entered.

4.9 Holiday function (D)

When display is unlocked, by touching "Holiday" (D), the Holiday icon (d) will be light, the fridge works in Holiday function. In Holiday mode, touching "Holiday" (D), the Holiday icon (d) is off, and the fridge exits the Holiday function. In the Holiday mode, the temperature is automatically set to 17 °C, so that your fridge will not generate odor, and also save energy.

**Notice: Holiday function**

1. In Holiday mode, temperature could not be adjusted. If you do so, Holiday icon will blink for 3 times to remind that the fridge is in Holiday mode.
2. In Holiday mode, if Auto Set, Daily or Super Cool function is set, "Holiday" icon (d) is off, Holiday function automatically exits, and enters Auto Set, Daily or Super Cool function.

4.10 Auto Set function (E)

When display is unlocked, by touching "Auto Set" (E), the Auto Set icon (e) is light, the fridge works in Auto Set function. In Auto Set mode, by touching "Auto Set" (E), the Auto Set icon (e) is off, and the fridge exits the Auto Set function.

Under the Auto Set function, the fridge operates at the 4 °C setting.

**Notice: Auto Set function**

1. In Auto Set mode, temperature could not be adjusted. If you do so, Auto Set icon will blink for 3 times to remind that the fridge is in Auto Set mode.
2. In Auto Set mode, if the Holiday, Daily or Super Cool function is set, "Auto Set" (e) is off, the Auto Set function automatically exits and enters Holiday, Daily or Super Cool function.

4.11 Display control function

When the door is closed the display screen turns off automatically 30 seconds after without operation. The display locks automatically. It lights up automatically when touching any key or opening the door.

4.12 Power-off memory

This product has a power failure memory function. The working state before power failure is memorized. After the power is turned on again, the fridge will continue to work according to the temperature and function status set before power failure. The Lock function is not remembered. After the fridge is powered on again, it will be unlocked.

4.13 Door open alarm

When fridge is kept open for more than 1 minute, beeper will make 3 beeps with interval of 0.5 second. The beeps will be repeated every 30 seconds if door is kept open. The beeps will stop until door is closed or after 7 minutes of door opening. The beeper stops beeping and fridge light goes off.

4.14 Error indication

When the display icon shows E1, E2 and other codes and flashes, it indicates that the fridge is faulty. In this situation, the fridge could still cool but user should contact aftersales service as soon as possible for optimal control of the fridge.



4.16 Energy saving tips

- ▶ Make sure the appliance is properly ventilated (see INSTALLATION).
- ▶ Do not install the appliance in direct sunlight or in the near of heat sources (e.g. stoves, heaters).
- ▶ Avoid unnecessarily low temperature in the appliance. The energy consumption increases the lower the temperature in the appliance is set.
- ▶ Allow warm food to cool down before placing it in the appliance.
- ▶ Open the appliance door as little and as briefly as possible.
- ▶ Make sure the door always closes correctly and unimpaired by food position. Keep door gasket clean.
- ▶ Clean the rear of the appliance regularly. Dust increases energy consumption.

5-Equipment

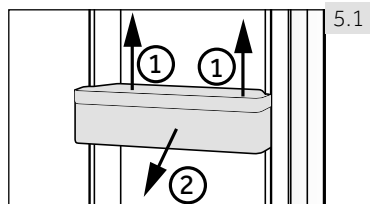

5.1

5.1 Removable door shelves

The door shelves can be removed for cleaning:

Place hands on each side of the shelf, lift it upwards (1) and pull it out (2) (Fig. 5.1).

In order to insert the door shelf, the above steps are carried out in reverse order.

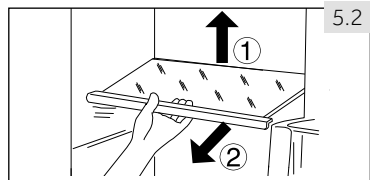

5.2

5.2 Glass shelves

1. To take out a shelf, remove it by first uplifting its hind edge (1) and pulling it out (2) (Fig. 5.2).

2. To reinstall it, put it on the lugs on both sides and push it to the most rearward position until the rear of the shelf is fixed inside the slots in the sides.

6.1 General

Clean the appliance when only little or no food is stored and unplug the appliance.

- ▶ Always keep the door gasket clean.
- ▶ Clean the inside and housing of the appliance with a sponge dampened in warm water and neutral detergent.

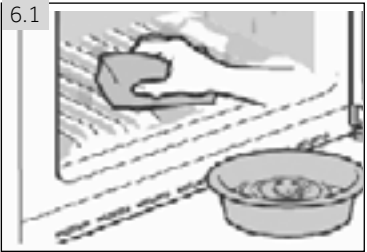

1. Please scrub the interior and exterior of the fridge, including door gasket, door shelves, glass shelves, boxes and so on, with a soft towel or sponge dipped in warm water (you may add neutral detergent into the warm water).
2. If there is liquid spilled, remove all the contaminated parts, directly rinse with the flow water, dry and place it back into the fridge.
3. If there is spilled cream (such as the cream, melting ice cream), please remove all the contaminated parts, put into the warm water with about 40 °C for some time, then rinse with the flow water, dry and place it back into the fridge.
4. In case some small part or component gets stucked inside of the fridge (between shelves or storage bins), use small soft brush to release it. If you could not reach the part, please contact Haier service.

6.2 Non-use for a longer period

If the appliance is not used for an extended period of time:

- ▶ Take out the food.
- ▶ Unplug the power cord.
- ▶ Clean the appliance as described above.
- ▶ Keep the door and fridge storage bins open to prevent the creation of bad odours inside.

Remove the door of the appliance (open the door and hold it before removing the screws) to avoid children entering into the appliance and getting locked in.



Notice: Switch off

To ensure the service life of the appliance, turn it off only if strictly necessary.

6.3 Moving the appliance

1. Remove all food and unplug the appliance.
2. Secure shelves and other moveable parts in the fridge with adhesive tape.
3. Close the door and secure it with tape.
4. Do not tilt the fridge more than 45° to avoid damaging the refrigerating system.
5. Wrap the feet of the fridge to avoid scratching the floor. Never move the fridge forcefully.

Many occurring problems could be solved by yourself without specific expertise. In case of a problem please check all shown possibilities and follow below instructions before you contact an after sales service.

The acoustic alarm can be switched of by pressing any button.

7.1 Troubleshooting

Problem	Possible Cause	Possible Solution
The compressor does not work.	<ul style="list-style-type: none"> • Mains plug is not connected in the mains socket. 	<ul style="list-style-type: none"> • Connect the mains plug.
The appliance runs frequently or for a too long period of time.	<ul style="list-style-type: none"> • The indoor or outdoor temperature is too high. • The appliance has been off power for a period of time. • The door of the appliance is not tightly closed. • The door has been opened too frequently or for too long. • The temperature setting is too low. • The door gasket is dirty, worn, cracked or mis-matched. • The required air circulation is not guaranteed. 	<ul style="list-style-type: none"> • In this case, it is normal for the appliance to run longer. • Normally, it takes 8 to 12 hours for the appliance to cool down completely. • Close the door and ensure the appliance is located on a level ground and there is no food or container jarring the door. • Do not open the door too frequently. • Set the temperature higher until a satisfactory temperature is obtained. It takes 24 hours for the temperature to become stable. • Clean the door gasket or replace them by the customer service. • Ensure adequate ventilation.
The appliance makes abnormal sounds.	<ul style="list-style-type: none"> • The appliance is not located on level ground. • The appliance touches an object close to it. • The appliance stands on a wooden floor or near wooden walls. 	<ul style="list-style-type: none"> • Level the appliance. • Remove objects around the appliance. • Wood amplifies the sound. Set the appliance somewhere else.
The appliance makes a clicking sound	<ul style="list-style-type: none"> • This is normal. It is caused by the refrigeration unit switching on or off. 	<ul style="list-style-type: none"> • -
A slight sound is to be heard similar to that of flowing water.	<ul style="list-style-type: none"> • This is normal. 	<ul style="list-style-type: none"> • -

Problem	Possible Cause	Possible Solution
The appliance makes a motor sound	<ul style="list-style-type: none"> The refrigeration unit has just turned itself on. This is normal 	<ul style="list-style-type: none"> -
It is not cold enough inside the appliance.	<ul style="list-style-type: none"> The temperature is set too high. Goods that are too warm have been stored. Too much food has been stored at a time. The goods are too close to each other. The door is not tightly closed. The door has been opened too frequently or for too long. 	<ul style="list-style-type: none"> Reset the temperature. Always cool down goods before storing them. Always store small quantities of food. Leave a gap between several foods allowing air flowing. Close the door. Do not open the door too frequently.
It is too cold inside the appliance.	<ul style="list-style-type: none"> The temperature is set too low. The Super Cool function is activated or has been running too long. 	<ul style="list-style-type: none"> Reset the temperature. Switch off the Super Cool function.
Moisture accumulates on the surface of the appliance.	<ul style="list-style-type: none"> The climate is too warm and too damp. 	<ul style="list-style-type: none"> This is normal in damp climate and will change when the humidity decreases. Wipe dry with a cloth.
The cooling system does not work.	<ul style="list-style-type: none"> Mains plug is not connected to the mains socket. The power supply is not intact. 	<ul style="list-style-type: none"> Connect the mains plug. Check the electrical supply to the room. Call the local electricity company!
The sides of the cabinet and door strip get warm.	<ul style="list-style-type: none"> This is normal. 	<ul style="list-style-type: none"> -
You hear an alarm signal.	<ul style="list-style-type: none"> The door is open The temperature inside product is too high 	<ul style="list-style-type: none"> Close the door or silence the alarm manually.
The door is difficult to open.	<ul style="list-style-type: none"> Once the appliance runs, it has an internal vacuum. 	<ul style="list-style-type: none"> Open the door seal gently to let air enter the appliance. ↓
The door can't be closed properly. It always leaves a gap.	<ul style="list-style-type: none"> Because of the appliances's low temperature, the door seal can easily get hard and deformed. 	<ul style="list-style-type: none"> Use a hair dryer or put a hot towel on the spot where the gasket is deformed. When the gasket is soft once again, close the door and compress it tightly.

7.2 Power Interruption

In the event of a power cut, food should remain safely cold for about 15 hours. Follow these tips during a prolonged power interruption, especially in summer:

- ▶ Open the door as few times as possible.
- ▶ Do not put additional food into the fridge during a power interruption.
- ▶ If prior notice of a power interruption is given and the interruption duration is longer than 15 hours, make some ice and put it in a container in the top of the fridge compartment.
- ▶ As temperature in the fridge will rise during a power interruption or other failure, the storage period and edible quality of food will be reduced. Any food that defrosts should be either consumed, or cooked and refrozen (where suitable) soon afterwards in order to prevent health risks.



Notice: Memory function during power interruption

After restoration of power the appliance continues with the settings that were set before the power failure.

8.1 Unpacking

- Take the appliance out of the packaging.
- Remove all packaging materials.

8.2 Environmental conditions

The room temperature should always be between 18 °C and 43 °C, since it can influence the temperature inside the appliance and its energy consumption. Do not install the appliance near other heat-emitting appliances (ovens, refrigerators) without isolation.

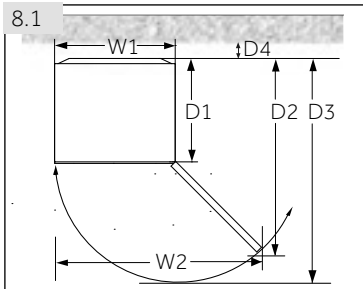

8.3 Space requirements

Required space to open the door (Fig. 8.1):

Width in mm		Depth in mm			Distance to wall in mm
W1	W2	D1	D2	D3	D4
705	1076	602	1243	1327	50

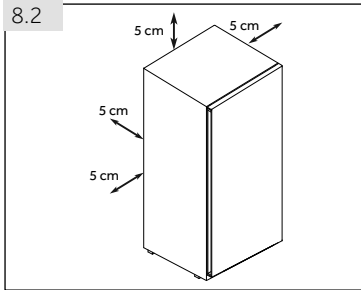

8.4 Ventilation cross-section

To achieve sufficient ventilation of the appliance for safety reasons, the information of the required ventilation cross sections must be observed (Fig. 8.2).

8.5 Aligning the appliance

The appliance should be placed on a flat and solid surface. If the appliance is placed on a pedestal, strong and fire-resistant materials must be used. Never use the foam packing material as a pedestal.

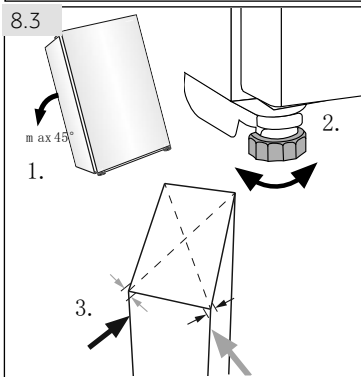

1. Tilt the appliance slightly backwards (Fig. 8.3).
2. Set the feet to the desired level.
3. The stability can be checked by alternately bumping on the diagonals. The slight swaying should be the same in both directions. Otherwise the frame can warp; possible leaking door seals are the result. A low tendency to the rear eases the closing of the door.

8.6 Using adjustable feet

If the fridge is unstable, the feet can be adjusted: Rotate the adjustable feet according to the direction of arrow (Fig. 8.4) to turn them up or down:

- ▶ Turning the feet clockwise raises the appliance.
- ▶ Turning the feet counterclockwise lowers it.

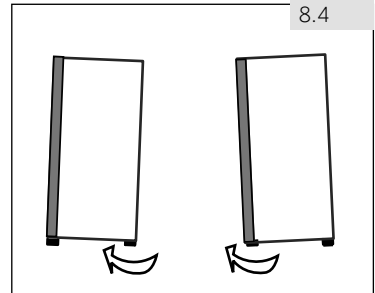

8.7 Waiting time

To the maintenance-free lubrication oil is located in the capsule of the compressor. This oil can get through the closed pipe system during slanting transport. Before connecting the appliance to the power supply you have to wait 2 hours (Fig. 8.5) so that the oil runs back into the capsule.

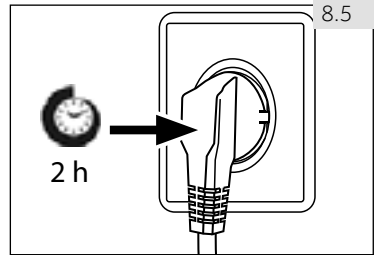

8.8 Electrical connection

Before each connection check if:

- ▶ Power supply, socket and fusing are appropriate to the rating plate.
- ▶ The power socket is earthed and no multi-plug or extension.
- ▶ The power plug and socket are strictly according.

Connect the plug to a properly installed household socket.

8.9 Door Reversibility

Before connecting the appliance to the power supply you should check, whether the door swing must be changed from right (as delivered) to left, if this is required by the installation location and the usability.

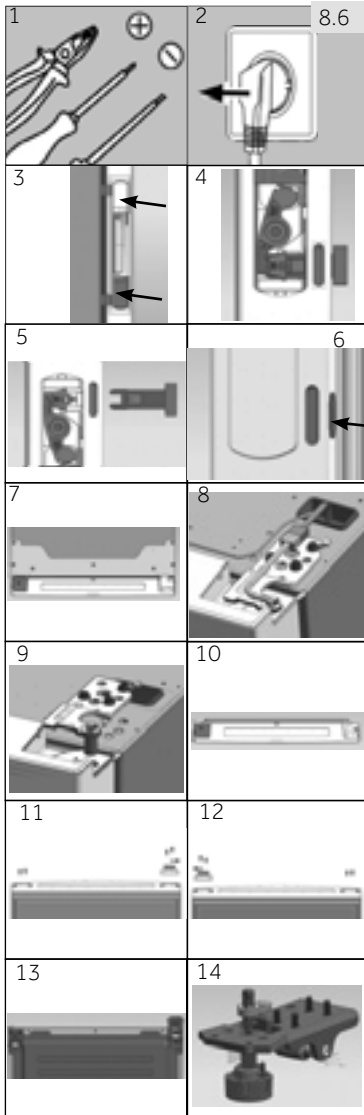

Assembly steps (Fig. 8.6):

1. Provide necessary tool.
2. Unplug the appliance.
3. Open the upper and lower handle covers on the left side of the door.
4. Pry the white slider slightly.
5. Take out the 2 push rod, and put the handle cover back on.
6. Remove the 2 rubber plugs on the right side of the door and put it with the removed push rods for step 20.
7. Remove 7 screws and hinge cover. Be careful not to tear the door cable .
8. Unplug the connection cable.
9. Remove 3 hinge screws and the right upper hinge, and remove the door carefully.
10. Place a cardboard box or cloth under the door and place the door horizontally. Remove the left door end cover, take the right end cover from the accessory bag. Install it on the top right side of the door.
11. Remove 2 screws on the left bottom of the door. Remove 2 screws, door stopper and axe cover on the right bottom of the door.
12. Take door stopper from last step and the left axe cover from the accessory bag, fix them with 2 screws. Fix 2 screws also on the other side of the door.
13. Put the back of the cabinet down after placing thicker pads on the ground. Remove 4 screws and the lower hinge.
14. Unscrew the axe cover.

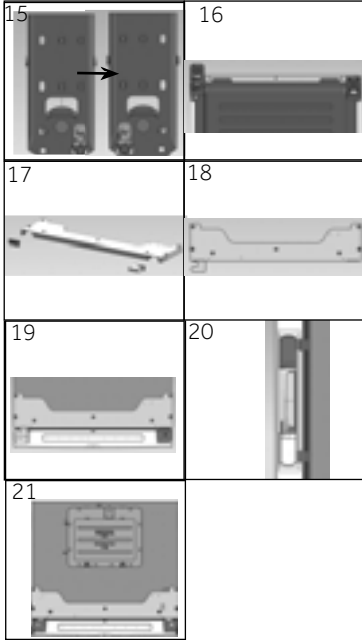

15. Take the left axe cover from the accessory bag. Fix it with screw .
16. Exchange position of caster plate and lower hinge after replacement.
17. Disassemble the right small hinge cover and hinge lid from the hinge cover.
18. Change the hinge lid to the other side. Take the left small hinge cover from the accessory bag. Install it on the hinge cover.
19. Mount the door, install the left hinge, plug the connection cable, and fix the hinge cover with screws.
20. Install the removed push rod on the right side of the door, and then insert the rubber plugs into handle push rod hole on the left side of the door.
21. Finished.

Trade mark	Haier
Model identifier	HRF505VW/HRF505VS
Category of the model	Fridge
Energy efficiency class	3.5 star
Product group	1
Storage volume cooling (L)	463
Storage volume freezing (L) ****	not applicable
Temperature of other compartments > 14 °C	not applicable
Frostfree system	yes
Construction type	freestanding
Climate class This appliance is intended to be used at an ambient temperature between 18 °C and 43 °C.	T
Voltage / Frequency	220-240V ~/ 50Hz
Rated Current (A)	0.8
Coolant	R600a
Dimensions (H/W/D in cm)	172,5/70,5/69,1

HRF505VWV/HRF505VS

Haier

0060530008A

