

VEVOR

Affordable. Reliable. Home Improvement.

CARPORT REPLACEMENT COVER

VEVOR

Affordable. Reliable. Home Improvement.

CARPORT REPLACEMENT COVER

**MODEL: SXYQCPBB10X20, SXYQCPBM10X20, SXYQCPBH10X20,
SXYQCPBH12X20, SXYQCPBH13X20, SXYQCPBL10X20,
SXYQCPBM12X20, SXYQCPBB12X20**



MODEL: SXYQCPBBW10X20, SXYQCPBHW10X20



MODEL: SXYQCPBBCP10X20, SXYQCPBHC12X20, SXYQCPBHC13X20



**MODEL: SXYQCPBHDC10X20, SXYQCPBMD10X20, SXYQCPBHDC12X20,
SXYQCPBHDC13X20,SXYQCPBHDC20X20**



This is the original instruction, please read all manual instructions carefully before operating. VEVOR reserves a clear interpretation of our user manual. The appearance of the product shall be subject to the product you received. Please forgive us that we won't inform you again if there are any technology or software updates on our product.



Warning-To reduce the risk of injury, user must read instructions manual carefully.

WARNING & PRECAUTIONS

WARNING:

- 1、 Avoid contact with sharp objects to prevent scratches.
- 2、 Keep all flame and heat sources away from the tarpaulin materials. Under no circumstance should any naked flame sources, fuel burning devices or heating devices be used under or nearby.
- 3、 Keep a fire extinguisher or water bucket nearby.

NOTICE:

- 1、 Clean with cold water and a soft brush-do not use soap or detergent.
- 2、 Do not expose to petrol, oil or solvents.

















People needed for installation

















PRODUCT DESCRIPTION

Material: waterproof UV woven polyethylene cover

Technological innovation: Hot Air and Extrusion Welding

Model	Color	Applicable carport sizes	Product	Accessories
SXYQCPBB10X20	White	10' L x 20' W, canopy With Edge		 x44
SXYQCPBM10X20	Beige			
SXYQCPBH10X20	Grey			
SXYQCPBBW10X20	White	10' L x 20' W, Without Edge		 x40
SXYQCPBBCP10X20	White	10' L x 20' W side canopy		 x40
SXYQCPBHDC10X20	Grey	10' L x 20' W, canopy side canopy		 x84
SXYQCPBH12X20	Grey	12' L x 20' W, canopy With Edge		 x48
SXYQCPBHC12X20	Grey	12' L x 20' W, side canopy		 x48
SXYQCPBH13X20	Grey	13' L x 20' W, canopy With Edge		 x52
SXYQCPBHC13X20	Grey	13' L x 20' W, side canopy		 x50

Model	Color	Applicable carport sizes	Product	Accessories
SXYQCPBL10X20	Green	10' L x 20' W, canopy With Edge		 x44
SXYQCPBM12X20	Beige	12' L x 20' W, canopy With Edge		 x48
SXYQCPBB12X20	White			
SXYQCPBMDC10 X20	Beige	10' L x 20' W, canopy side canopy		 x84
SXYQCPBHDC12 X20	Grey	12' L x 20' W, canopy side canopy		 x88
SXYQCPBHW10X 20	Grey	10' L x 20' W, Without Edge		 x40
SXYQCPBHDC13 X20	Grey	13' L x 20' W, canopy side canopy		 x92
SXYQCPBHDC20 X20	Grey	20' L x 20' W, canopy side canopy		 x96

ASSEMBLY INSTRUCTIONS

Canopy Assembly

1、Unpack and take out tarpaulin and a bundle of bouncy balls.



2. Unfold the product and lay it flat on top of the stand.

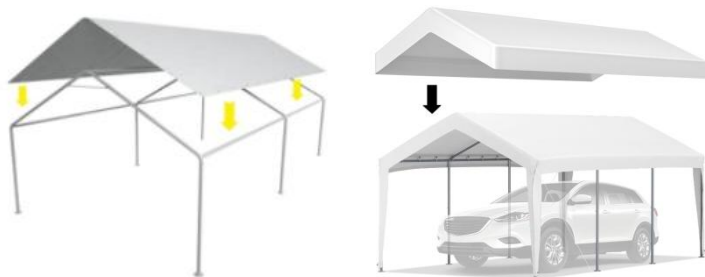

3. Pass the bouncy tether balls through the reserved hole in the tarpaulin and connect it to the metal bracket. And install the hooks on the leg wraps in the appropriate holes on the feet of the stand



You can refer to the picture above for hooking. When the size of the hook is insufficient, a stretch ball can also be used for connection.

Side Canopy Assembly

1、Unpack and take out tarpaulin and a bundle of bouncy tether balls.



2、Unfold the tarpaulin around the bracket and insert bouncy tether balls through the metal holes to secure it to the bracket.

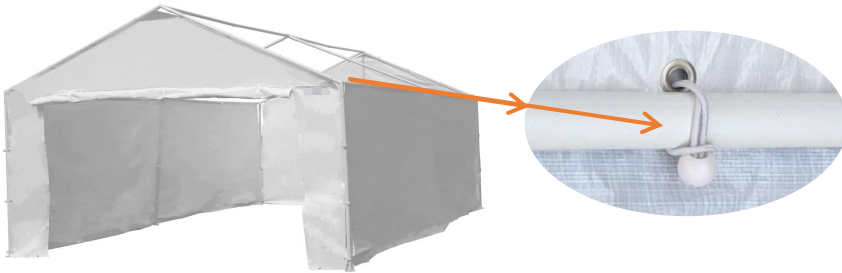

3、The tarpaulin that serves as the door is fastened to the bracket with Velcro.

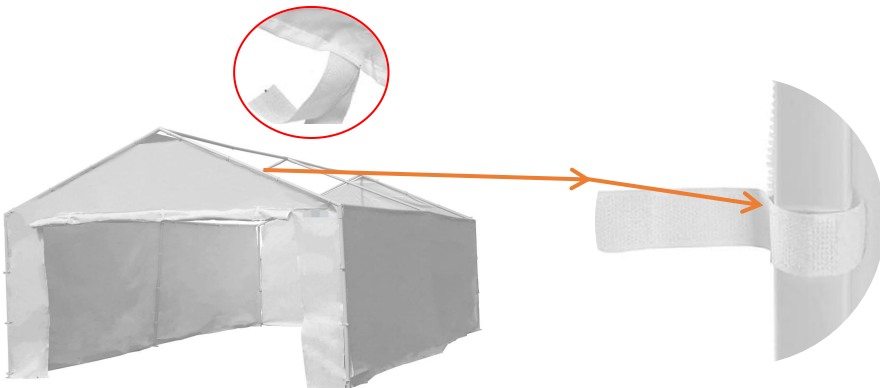

Manufacturer: Shanghai muxinmuyeyouxiangongsi

Address: Shuangchenglu 803nong11hao1602A-1609shi, baoshanqu, shanghai 200000 CN.

Imported to AUS: SIHAO PTY LTD. 1 ROKEVA STREET EASTWOOD NSW 2122 Australia

Imported to USA: Sanven Technology Ltd. Suite 250, 9166 Anaheim Place, Rancho Cucamonga, CA 91730

UK	REP
-----------	------------

YH CONSULTING LIMITED. C/O YH Consulting Limited Office 147, Centurion House, London Road, Staines-upon-Thames, Surrey, TW18 4AX

EC	REP
-----------	------------

E-CrossStu GmbH
Mainzer Landstr.69,
60329 Frankfurt am Main.



VEVOR

Affordable. Reliable. Home Improvement.

**COUVERTURE DE REMPLACEMENT POUR
ABRI D'AUTO**

VEVOR

Affordable. Reliable. Home Improvement.

CARPORT REPLACEMENT COVER

**MODÈLE : SXYQCPBB10X20 , SXYQCPBM10X20 , SXYQCPBH10X20 ,
SXYQCPBH12X20 , SXYQCPBH13X20 , SXYQCPBL10X20 ,
SXYQCPBM12X20 , SXYQCPBB12X20**



MODÈLE : SXYQCPBBW10X20 ,SXYQCPBHW10X20



MODÈLE : SXYQCPBBCP10X20 , SXYQCPBHC12X20 , SXYQCPBHC13X20



**MODÈLE : SXYQCPBHDC10X20 , SXYQCPBMDC10X20,
SXYQCPBHDC12X20,
SXYQCPBHDC13X20, SXYQCPBHDC20X20**



This is the original instruction, please read all manual instructions carefully before operating. VEVOR reserves a clear interpretation of our user manual. The appearance of the product shall be subject to the product you received. Please forgive us that we won't inform you again if there are any technology or software updates on our product.



**Avertissement - Pour réduire le risque de blessure,
l'utilisateur doit lire attentivement le manuel d'instructions.**

WARNING & PRECAUTIONS

AVERTISSEMENT :

1. Évitez tout contact avec des objets tranchants pour éviter les rayures .
2. Tenir toute source de flamme et de chaleur éloignée des bâches. En aucun cas, aucune flamme nue, aucun appareil à combustible ni aucun appareil de chauffage ne doit être utilisé sous ou à proximité .
- 3 、 Gardez un extincteur ou un seau d'eau à proximité.

AVIS :

- 1 、 Nettoyer à l'eau froide et avec une brosse douce - ne pas utiliser de savon ni de détergent.
- 2 、 Ne pas exposer à l'essence, à l'huile ou aux solvants.

















Personnes nécessaires pour l'installation

















PRODUCT DESCRIPTION

Matériau : housse en polyéthylène tissé imperméable aux UV

Innovation technologique : soudage à air chaud et par extrusion

Modèle	Couleur	Dimensions d'abris de voiture applicables	Produit	Accessoires
SXYQCPBB10X20	Blanc	10' L x 20' I, baldaquin Avec Edge		 x4 4
SXYQCPBM10X20	Beige			
SXYQCPBH10X20	Gris			
SXYQCPBBW10X20	Blanc	10' L x 20' I, sans bordure		 x40
SXYQCPBBCP10X20	Blanc	10' L x 20' I auvent latéral		 x40
SXYQCPBHDC10X20	Gris	10' L x 20' I, baldaquin auvent latéral		 x8 4
SXYQCPBH12X20	Gris	12' L x 20' I, baldaquin Avec Edge		 x48
SXYQCPBHC12X20	Gris	12' L x 20' I, auvent latéral		 x4 8
SXYQCPBH13X20	Gris	13' L x 20' I, baldaquin Avec Edge		 x5 2
SXYQCPBHC13X20	Gris	13' L x 20' I, auvent latéral		 x 50

Modèle	Couleur	Dimensions d'abris de voiture applicables	Produit	Accessoires
SXYQCPBL10X20	Vert	10' L x 20' l, baldaquin Avec Edge		 x4 4
SXYQCPBM12X20	Beige	12' L x 20' l, baldaquin Avec Edge		 x4 8
SXYQCPBB12X20	Blanc			
SXYQCPBMDC10 X20	Beige	10' L x 20' l, baldaquin auvent latéral		 x 84
SXYQCPBHDC12 X20	Gris	12' L x 20' l, baldaquin auvent latéral		 x 88
SXYQCPBHW10X 20	Gris	10' L x 20' l, sans bordure		 x 40
SXYQCPBHDC13 X20	Gris	13' L x 20' l, baldaquin auvent latéral		 x 92
SXYQCPBHDC20 X20	Gris	20' L x 20' l, baldaquin auvent latéral		 x 96

ASSEMBLY INSTRUCTIONS

Assemblage de la verrière

1、 Déballer et sortir la bâche et un paquet de jouets gonflables des balles.



2. Dépliez le produit et posez-le à plat sur le dessus du support.

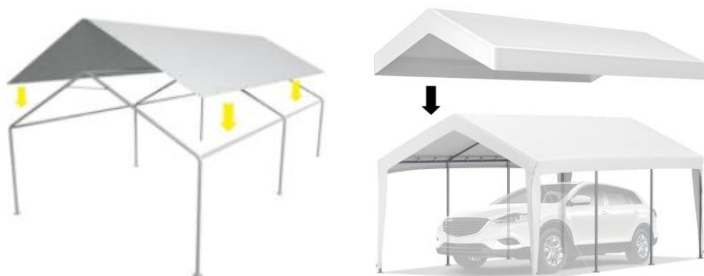

3. Passez les balles rebondissantes Insérez-la dans le trou prévu à cet effet dans la bâche et fixez-la au support métallique. Installez ensuite les crochets des sangles de maintien dans les trous prévus à cet effet sur les pieds du support.



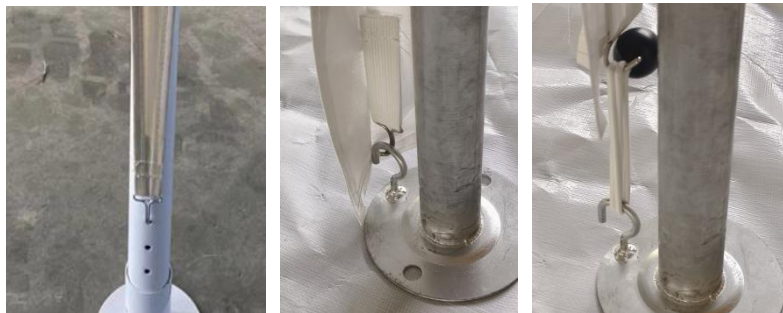

Vous pouvez vous référer à l'image ci-dessus pour l'accrochage . Si la taille de l'hameçon est insuffisante, une boule extensible peut également être utilisée pour la connexion.

Assemblage de l'auvent latéral

1. Déballez et sortez la bâche et un paquet de balles rebondissantes .



2. Dépliez la bâche autour du support et insérez les balles d'attache rebondissantes dans les trous métalliques pour la fixer au support.

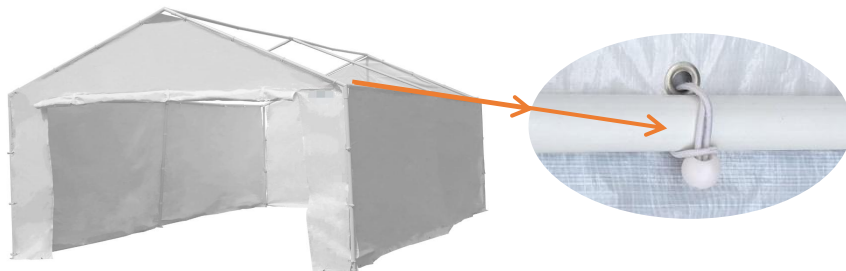

3. La bâche qui sert de porte est fixée au support avec du velcro.



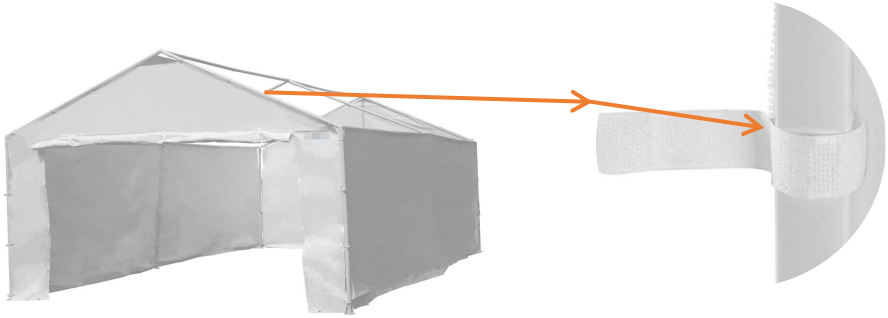

Fabricant : Shanghaimuxinmuyeyouxiangongsi

Adresse : Shuangchenglu 803nong11hao1602A-1609shi, baoshanqu, Shanghai 200 000 CN.

Importé en Australie : SIHAO PTY LTD. 1 ROKEVA STREET, ASTWOOD NSW 2122 Australie

Importé aux États-Unis : Sanven Technology Ltd. Suite 250, 9166 Anaheim

Lieu, Rancho Cucamonga, CA 91730

UK	REP
-----------	------------

YH CONSULTING LIMITED. C/O YH Consulting Limited Office 147, Centurion House, London Road, Staines-upon-Thames, Surrey, TW18 4AX

EC	REP
-----------	------------

E-CrossStu GmbH
Mainzer Landstr.69,
60329 Frankfurt am Main.



VEVOR

Affordable. Reliable. Home Improvement.

CARPORT-ERSATZABDECKUNG

VEVOR

Affordable. Reliable. Home Improvement.

CARPORT REPLACEMENT COVER

**MODELL: SXYQCPBB10X20 , SXYQCPBM10X20 , SXYQCPBH10X20 ,
SXYQCPBH12X20 , SXYQCPBH13X20 , SXYQCPBL10X20 ,
SXYQCPBM12X20, SXYQCPBB12X20**



MODELL: SXYQCPBBW10X20 , SXYQCPBHW10X20



MODELL: SXYQCPBBCP10X20 , SXYQCPBHC12X20 , SXYQCPBHC13X20



**MODELL: SXYQCPBHDC10X20 , SXYQCPBMDC10X20,
SXYQCPBHDC12X20,
SXYQCPBHDC13X20, SXYQCPBHDC20X20**



This is the original instruction, please read all manual instructions carefully before operating. VEVOR reserves a clear interpretation of our user manual. The appearance of the product shall be subject to the product you received. Please forgive us that we won't inform you again if there are any technology or software updates on our product.



Warnung: Um das Verletzungsrisiko zu verringern, muss der Benutzer die Bedienungsanleitung sorgfältig lesen.

WARNING & PRECAUTIONS

WARNUNG :

1. Vermeiden Sie den Kontakt mit scharfen Gegenständen, um Kratzer zu vermeiden .
2. Halten Sie alle Flammen und Wärmequellen von den Planenmaterialien fern. Unter keinen Umständen dürfen offene Flammen, Brennstoffbrenner oder Heizgeräte unter oder in der Nähe der Plane verwendet werden .
3. Halten Sie einen Feuerlöscher oder einen Wassereimer bereit .

BEACHTEN :

1. Mit kaltem Wasser und einer weichen Bürste reinigen – keine Seife oder Reinigungsmittel verwenden.
2. Nicht Benzin, Öl oder Lösungsmitteln aussetzen.

Für die Installation benötigtes Personal

































PRODUCT DESCRIPTION

Material: wasserdichte, UV-beständige Abdeckung aus gewebtem Polyethylen

Technologische Innovation: Heißluft- und Extrusionsschweißen

Modell	Farbe	Anwendbare	Produkt	Zubehör
--------	-------	------------	---------	---------

		Carpportgrößen		
SXYQCPBB10X20	Weiß	10' L x 20' B, Überdachung Mit Edge		 x4 4
SXYQCPBM10X20	Beige			
SXYQCPBH10X20	Grau			
SXYQCPBBW10X20	Weiß	10' L x 20' B, ohne Rand		 x40
SXYQCPBBCP10X20	Weiß	10' L x 20' B Seitendach		 x40
SXYQCPBHDC10X20	Grau	10' L x 20' B , Überdachung Seitendach		 x8 4
SXYQCPBH12X20	Grau	12' L x 20' B , Überdachung Mit Edge		 x48
SXYQCPBHC12X20	Grau	12' L x 20' B , Seitendach		 x4 8
SXYQCPBH13X20	Grau	13' L x 20' B , Überdachung Mit Edge		 x5 2
SXYQCPBHC13X20	Grau	13' L x 20' B , Seitendach		 x 50

Modell	Farbe	Anwendbare Carportgrößen	Produkt	Zubehör
SXYQCPBL10X20	Grün	10' L x 20' B, Überdachung Mit Edge		 x4 4
SXYQCPBM12X20	Beige	12' L x 20' B, Überdachung Mit Edge		 x4 8
SXYQCPBB12X20	Weiß			
SXYQCPBMDC10 X20	Beige	10' L x 20' B , Überdachung Seitendach		 x 84
SXYQCPBHDC12 X20	Grau	12' L x 20' B , Überdachung Seitendach		 x 88
SXYQCPBHW10X 20	Grau	10' L x 20' B, ohne Rand		 x 40
SXYQCPBHDC13 X20	Grau	13' L x 20' B , Überdachung Seitendach		 x 92
SXYQCPBHDC20 X20	Grau	20' L x 20' B , Überdachung Seitendach		 x 96

ASSEMBLY INSTRUCTIONS

Baldachin A Montage

1、Auspacken und Plane und ein Bündel Hüpfburgen herausnehmen Bälle.



2. Entfalten Sie das Produkt und legen Sie es flach auf den Ständer.

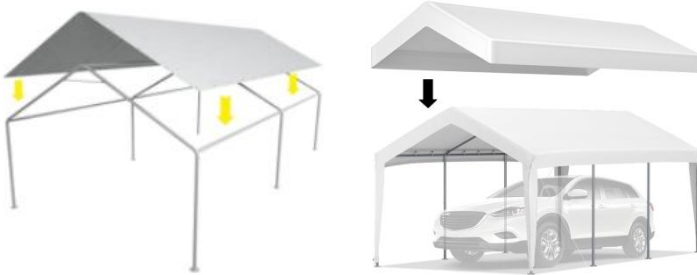

3. Geben Sie die Hüpfbälle weiter durch das dafür vorgesehene Loch in der Plane und befestigen Sie es an der Metallhalterung. Und befestigen Sie die Haken an den Beinschlaufen in den entsprechenden Löchern an den Füßen des Ständers





Zum Einhängen können Sie sich an der Abbildung oben orientieren . Wenn die Größe des Hakens nicht ausreicht, kann auch ein Stretchball zum Verbinden verwendet werden.

Seitendach A- Montage

1. Packen Sie die Plane und ein Bündel Hüpfbälle aus und nehmen Sie sie heraus .



2. Entfalten Sie die Plane um die Halterung und stecken Sie federnde Haltebälle durch die Metalllöcher, um sie an der Halterung zu befestigen.

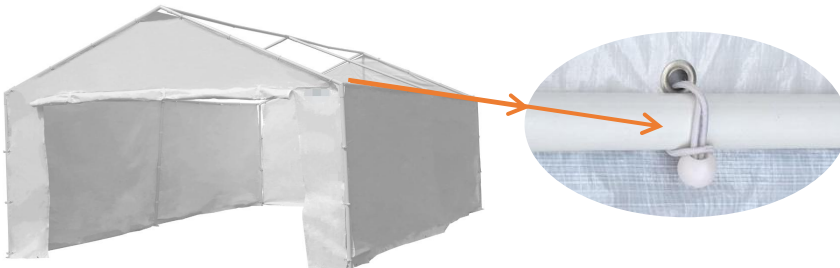

3. Die Plane, die als Tür dient, wird mit Klettverschluss an der Halterung befestigt.

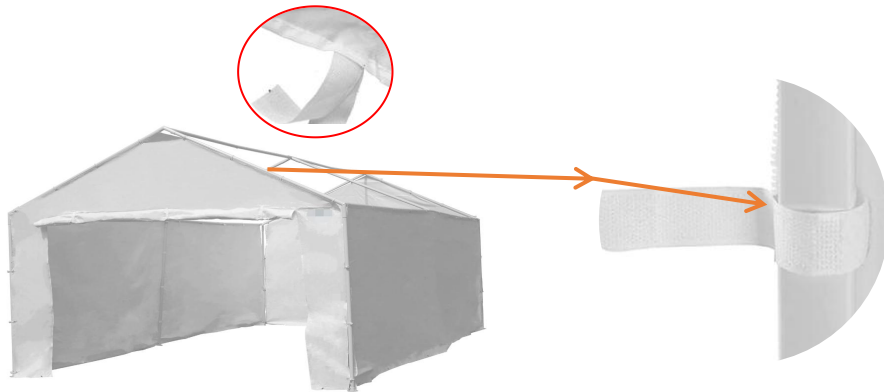

Hersteller: Shanghaimuxinmuyeyouxiangongsi

Adresse: Shuangchenglu 803nong11hao1602A-1609shi, baoshanqu, Shanghai 200.000 CN.

Importiert nach AUS: SIHAO PTY LTD. 1 ROKEVA STREETEASTWOOD NSW 2122 Australien

Importiert in die USA: Sanven Technology Ltd. Suite 250, 9166 Anaheim Place, Rancho Cucamonga, CA 91730

UK	REP
-----------	------------

YH CONSULTING LIMITED. C/O YH Consulting Limited Office 147, Centurion House, London Road, Staines-upon-Thames, Surrey, TW18 4AX

EC	REP
-----------	------------

E-CrossStu GmbH
Mainzer Landstr.69,
60329 Frankfurt am Main.



VEVOR

Affordable. Reliable. Home Improvement.

**COPERTURA SOSTITUTIVA PER POSTO AUTO
COPERTO**

VEVOR

Affordable. Reliable. Home Improvement.

CARPORT REPLACEMENT COVER

**MODELLO: SXYQCPBB10X20 , SXYQCPBM10X20 , SXYQCPBH10X20 ,
SXYQCPBH12X20 , SXYQCPBH13X20 , SXYQCPBL10X20 ,
SXYQCPBM12X20, SXYQCPBB12X20**



MODELLO: SXYQCPBBW10X20 , SXYQCPBHW10X20



MODELLO: SXYQCPBBCP10X20 , SXYQCPBHC12X20 , SXYQCPBHC13X20



**MODELLO: SXYQCPBHDC10X20 , SXYQCPBMDC10X20,
SXYQCPBHDC12X20,
SXYQCPBHDC13X20, SXYQCPBHDC20X20**



This is the original instruction, please read all manual instructions carefully before operating. VEVOR reserves a clear interpretation of our user manual. The appearance of the product shall be subject to the product you received. Please forgive us that we won't inform you again if there are any technology or software updates on our product.



Avvertenza: per ridurre il rischio di lesioni, l'utente deve leggere attentamente il manuale di istruzioni.

WARNING & PRECAUTIONS

AVVERTIMENTO :

1. Evitare il contatto con oggetti appuntiti per evitare graffi .
2. Tenere tutte le fiamme libere e le fonti di calore lontane dai materiali del telone. Non utilizzare in nessun caso fiamme libere, dispositivi a combustione o dispositivi di riscaldamento sotto o nelle vicinanze .
3. Tenere un estintore o un secchio d'acqua nelle vicinanze .

AVVISO :

1. Pulire con acqua fredda e una spazzola morbida. Non utilizzare sapone o detersivo.
2. Non esporre a benzina, olio o solventi .

Persone necessarie per l'installazione



















PRODUCT DESCRIPTION















Materiale: copertura in polietilene intrecciato impermeabile ai raggi UV

Innovazione tecnologica: Saldatura ad aria calda ed estrusione

Modello	Color e	Dimensioni applicabili del posto	Prodotto	Accesso ri
---------	---------	----------------------------------	----------	------------

		auto coperto		
SXYQCPBB10X20	Bianco	10' L x 20' W, baldacchino Con bordo		 x4 4
SXYQCPBM10X20	Beige			
SXYQCPBH10X20	Grigio			
SXYQCPBBW10X 20	Bianco	10' L x 20' W, senza bordo		 x40
SXYQCPBBCP10 X20	Bianco	10' L x 20' W tettoia laterale		 x40
SXYQCPBHDC10 X20	Grigio	10' L x 20' W , baldacchino tettoia laterale		 x8 4
SXYQCPBH12X20	Grigio	12' L x 20' W , baldacchino Con bordo		 x48
SXYQCPBHC12X 20	Grigio	12' L x 20' W , tettoia laterale		 x4 8
SXYQCPBH13X20	Grigio	13' L x 20' W , baldacchino Con bordo		 x5 2
SXYQCPBHC13X 20	Grigio	13' L x 20' W , tettoia laterale		 x 50

Modello	Color	Dimensioni	Prodotto	Accesso
----------------	--------------	-------------------	-----------------	----------------

	e	applicabili del posto auto coperto		ri
SXYQCPBL10X20	Verde	10' L x 20' W, baldacchino Con bordo		 x4 4
SXYQCPBM12X20	Beige	12' L x 20' W, baldacchino Con bordo		 x4 8
SXYQCPBB12X20	Bianco			
SXYQCPBMDC10 X20	Beige	10' L x 20' W , baldacchino tettoia laterale		 x 84
SXYQCPBHDC12 X20	Grigio	12' L x 20' W , baldacchino tettoia laterale		 x 88
SXYQCPBHW10X 20	Grigio	10' L x 20' W, senza bordo		 40 pagine
SXYQCPBHDC13 X20	Grigio	13' L x 20' W , baldacchino tettoia laterale		 x 92
SXYQCPBHDC20 X20	Grigio	20' L x 20' W , baldacchino tettoia laterale		 x 96

ASSEMBLY INSTRUCTIONS

Montaggio del baldacchino

1. Disimballare e togliere il telone e un fascio di materassini gonfiabili palle.



2. Aprire il prodotto e adagiarlo disteso sulla parte superiore del supporto.

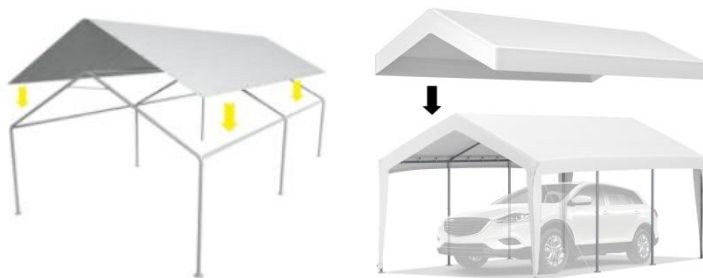

3. Passare le palline rimbalzanti Attraverso il foro previsto nel telone e collegarlo alla staffa metallica. Quindi, installare i ganci delle fasce per le gambe negli appositi fori sui piedi del supporto.





Per l'aggancio, fare riferimento all'immagine sopra . Se la dimensione dell'aggancio non è sufficiente, è possibile utilizzare anche una sfera elastica per il collegamento.

Montaggio del tettuccio laterale

1. Disimballare e togliere il telone e un fascio di palline rimbalzanti .



2. Aprire il telo attorno alla staffa e inserire le palline rimbalzanti attraverso i fori metallici per fissarlo alla staffa.

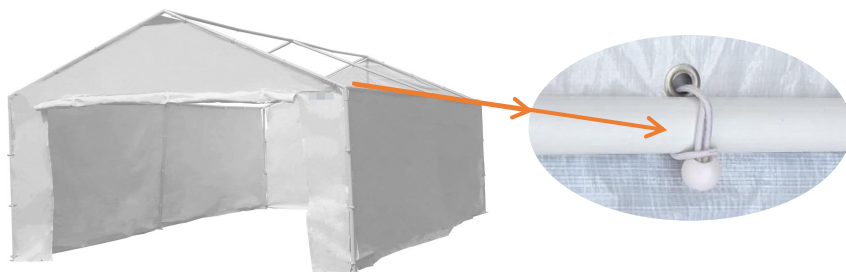

3. Il telone che funge da porta viene fissato alla staffa tramite velcro.



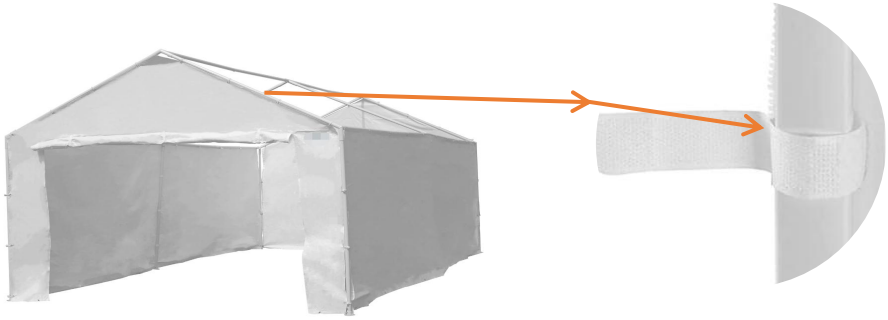

Produttore: Shanghai muxinmuyeyouxiangongsi

Indirizzo: Shuangchenglu 803nong11hao1602A-1609shi, baoshanqu, shanghai 200000 CN.

Importato in AUS: SIHAO PTY LTD. 1 ROKEVA STREET EASTWOOD
Nuovo Galles del Sud 2122 Australia

Importato negli USA: Sanven Technology Ltd. Suite 250, 9166 Anaheim
Luogo, Rancho Cucamonga, CA 91730

UK	REP
-----------	------------

YH CONSULTING LIMITED. C/O YH Consulting
Limited Office 147, Centurion House, London
Road, Staines-upon-Thames, Surrey, TW18 4AX

EC	REP
-----------	------------

E-CrossStu GmbH
Mainzer Landstr.69,
60329 Frankfurt am Main.



VEVOR

Affordable. Reliable. Home Improvement.

CUBIERTA DE REEMPLAZO PARA COCHERA

VEVOR

Affordable. Reliable. Home Improvement.

CARPORT REPLACEMENT COVER

**MODELO: SXYQCPBB10X20 , SXYQCPBM10X20 , SXYQCPBH10X20 ,
SXYQCPBH12X20 , SXYQCPBH13X20 , SXYQCPBL10X20 ,
SXYQCPBM12X20, SXYQCPBB12X20**



MODELO: SXYQCPBBW10X20 , SXYQCPBHW10X20



MODELO: SXYQCPBBCP10X20 , SXYQCPBHC12X20 , SXYQCPBHC13X20



**MODELO: SXYQCPBHDC10X20 , SXYQCPBMDC10X20,
SXYQCPBHDC12X20,
SXYQCPBHDC13X20, SXYQCPBHDC20X20**



This is the original instruction, please read all manual instructions carefully before operating. VEVOR reserves a clear interpretation of our user manual. The appearance of the product shall be subject to the product you received. Please forgive us that we won't inform you again if there are any technology or software updates on our product.



Advertencia: Para reducir el riesgo de lesiones, el usuario debe leer atentamente el manual de instrucciones.

WARNING & PRECAUTIONS

ADVERTENCIA :

1. Evite el contacto con objetos afilados para evitar rayones .
2. Mantenga cualquier llama o fuente de calor alejada de la lona. Bajo ninguna circunstancia se deben usar llamas abiertas, dispositivos que queman combustible o aparatos de calefacción debajo o cerca de la lona .
- 3 、 Mantenga un extintor de incendios o un balde de agua cerca.

AVISO :

1. Limpiar con agua fría y un cepillo suave. No utilizar jabón ni detergente.
- 2 、 No exponer a gasolina, aceite o disolventes.

Se necesitan personas para la instalación































PRODUCT DESCRIPTION



Material: cubierta de polietileno tejido resistente a los rayos UV.

Innovación tecnológica: Soldadura por aire caliente y extrusión

Modelo	Color	Tamaños de cocheras	Producto	Accesorios
--------	-------	---------------------	----------	------------

		aplicables		
SXYQCPBB10X20	Blanco	10' de largo x 20' de ancho, pabellón Con Edge		 x4 4
SXYQCPBM10X20	Beige			
SXYQCPBH10X20	Gris			
SXYQCPBBW10X 20	Blanco	10' de largo x 20' de ancho, sin borde		 x40
SXYQCPBBCP10 X20	Blanco	10' de largo x 20' de ancho dosel lateral		 x40
SXYQCPBHDC10 X20	Gris	10' de largo x 20' de ancho , pabellón dosel lateral		 x8 4
SXYQCPBH12X20	Gris	12' de largo x 20' de ancho , pabellón Con Edge		 x48
SXYQCPBHC12X 20	Gris	12' de largo x 20' de ancho , dosel lateral		 x4 8
SXYQCPBH13X20	Gris	13' de largo x 20' de ancho , pabellón Con Edge		 x5 2
SXYQCPBHC13X 20	Gris	13' de largo x 20' de ancho , dosel lateral		 x 50

Modelo	Color	Tamaños de cocheras aplicables	Producto	Accesorios
SXYQCPBL10X20	Verde	10' de largo x 20' de ancho, pabellón Con Edge		 x4 4
SXYQCPBM12X20	Beige	12' de largo x 20' de ancho, pabellón Con Edge		 x4 8
SXYQCPBB12X20	Blanco			
SXYQCPBMDC10 X20	Beige	10' de largo x 20' de ancho , pabellón dosel lateral		 x84
SXYQCPBHDC12 X20	Gris	12' de largo x 20' de ancho , pabellón dosel lateral		 x88
SXYQCPBHW10X 20	Gris	10' de largo x 20' de ancho, sin borde		 x40
SXYQCPBHDC13 X20	Gris	13' de largo x 20' de ancho , pabellón dosel lateral		 x 92

<p>SXYQCPBHDC20 X20</p>	<p>Gris</p>	<p>20 ' de largo x 20' de ancho , pabellón dosel lateral</p>		 x 96
-----------------------------	-------------	--	---	--

ASSEMBLY INSTRUCTIONS

Conjunto de dosel

1、 Desempaque y saque la lona y un paquete de artículos elásticos. bolas.



2、 Despliega el producto y colócalo plano encima del soporte.

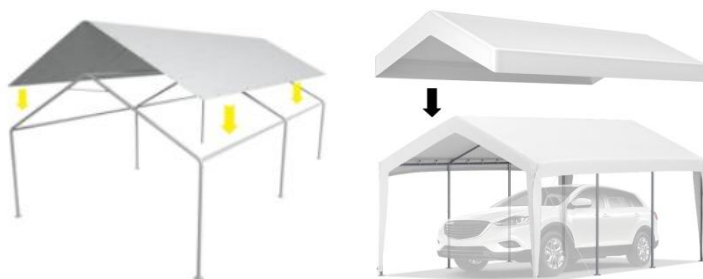

3、 Pasa las pelotas de cuerda que rebotan Pase el soporte por el orificio reservado en la lona y conéctelo al soporte metálico. Instale los ganchos de las correas de las patas en los orificios correspondientes de las patas del soporte.





Puedes consultar la imagen de arriba para ver cómo enganchar . Si el tamaño del anzuelo es insuficiente, también puedes usar una bola elástica para conectarlo.

Conjunto de cubierta lateral

1、 Desempaque y saque la lona y un paquete de pelotas de amarre elásticas .



2、 Despliega la lona alrededor del soporte e inserta bolas de amarre elásticas a través de los orificios de metal para asegurarla al soporte.

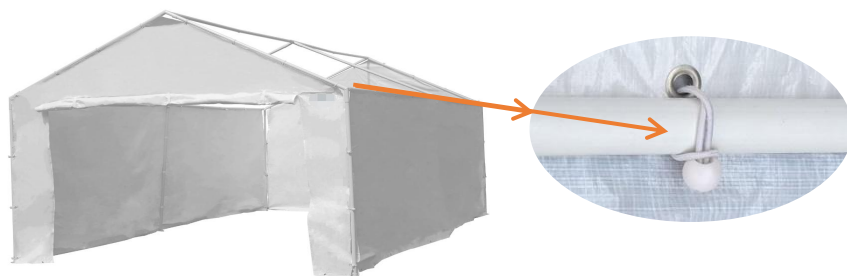

3. La lona que sirve de puerta se fija al soporte con velcro.

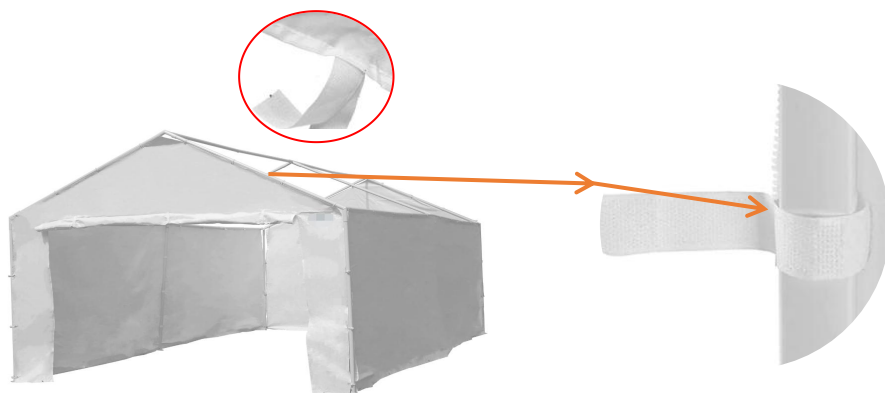

Fabricante: Shanghaimuxinmuyeyouxiangongsi

Dirección: Shuangchenglu 803nong11hao1602A-1609shi, baoshanqu, Shanghái 200000 CN.

Importado a AUS: SIHAO PTY LTD. 1 ROKEVA STREET, EASTWOOD NSW 2122 Australia

Importado a EE. UU.: Sanven Technology Ltd. Suite 250, 9166 Anaheim Lugar, Rancho Cucamonga, CA 91730

UK	REP	YH CONSULTING LIMITED. C/O YH Consulting Limited Office 147, Centurion House, London Road, Staines-upon-Thames, Surrey, TW18 4AX
-----------	------------	--

EC	REP	E-CrossStu GmbH Mainzer Landstr.69, 60329 Frankfurt am Main.
-----------	------------	--



VEVOR

Affordable. Reliable. Home Improvement.

VERVANGENDE AFDEKKING VOOR CARPORT

VEVOR

Affordable. Reliable. Home Improvement.

CARPORT REPLACEMENT COVER

**MODEL: SXYQCPBB10X20 , SXYQCPBM10X20 , SXYQCPBH10X20 ,
SXYQCPBH12X20 , SXYQCPBH13X20 , SXYQCPBL10X20 ,
SXYQCPBM12X20,SXYQCPBB12X20**



MODEL: SXYQCPBBW10X20 , SXYQCPBHW10X20



MODEL: SXYQCPBBCP10X20 , SXYQCPBHC12X20 , SXYQCPBHC13X20



**MODEL: SXYQCPBHDC10X20 , SXYQCPBMDC10X20, SXYQCPBHDC12X20,
SXYQCPBHDC13X20,SXYQCPBHDC20X20**



This is the original instruction, please read all manual instructions carefully before operating. VEVOR reserves a clear interpretation of our user manual. The appearance of the product shall be subject to the product you received. Please forgive us that we won't inform you again if there are any technology or software updates on our product.



Waarschuwing: om het risico op letsel te verminderen, dient de gebruiker de gebruiksaanwijzing zorgvuldig te lezen.

WARNING & PRECAUTIONS

WAARSCHUWING :

1. Vermijd contact met scherpe voorwerpen om krassen te voorkomen .
2. Houd alle vlammen en warmtebronnen uit de buurt van het zeildoek. Open vuur, brandstofverbrandende apparaten of verwarmingsapparaten mogen onder geen beding onder of in de buurt worden gebruikt .
3. Houd een brandblusser of een emmer met water bij de hand .

KENNISGEVING :

1. Maak schoon met koud water en een zachte borstel. Gebruik geen zeep of schoonmaakmiddel.
2. Niet blootstellen aan benzine, olie of oplosmiddelen.

Mensen nodig voor installatie

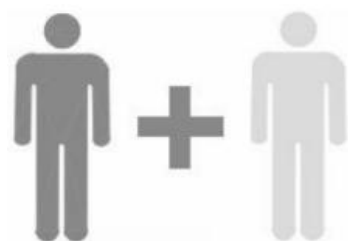

















PRODUCT DESCRIPTION















Materiaal: waterdichte UV-geweven polyethyleen hoes

Technologische innovatie: hetelucht- en extrusielassen

Model	Kleur	Toepasselijk e carportafmet ingen	Product	Accesso ires
-------	-------	--	---------	-----------------

SXYQCPBB10X20	Wit	10' L x 20' B, overkapping Met rand		 x4 4
SXYQCPBM10X20	Beige			
SXYQCPBH10X20	Grijs			
SXYQCPBBW10X 20	Wit	10' L x 20' B, zonder rand		 x40
SXYQCPBBCP10 X20	Wit	10' L x 20' B zijluifel		 x40
SXYQCPBHDC10 X20	Grijs	10' L x 20' B , overkapping zijluifel		 x8 4
SXYQCPBH12X20	Grijs	12' L x 20' B , overkapping Met rand		 x48
SXYQCPBHC12X 20	Grijs	12' L x 20' B , zijluifel		 x4 8
SXYQCPBH13X20	Grijs	13' L x 20' B , overkapping Met rand		 x5 2
SXYQCPBHC13X 20	Grijs	13' L x 20' B , zijluifel		 x 50

Model	Kleur	Toepasselijk e	Product	Accesso ires
-------	-------	-------------------	---------	-----------------

		carportafmetingen		
SXYQCPBL10X20	Groente	10' L x 20' B, overkapping Met rand		 x4 4
SXYQCPBM12X20	Beige	12' L x 20' B, overkapping Met rand		 x4 8
SXYQCPBB12X20	Wit			
SXYQCPBMDC10 X20	Beige	10' L x 20' B , overkapping zijluifel		 x84
SXYQCPBHDC12 X20	Grijs	12' L x 20' B , overkapping zijluifel		 x88
SXYQCPBHW10X 20	Grijs	10' L x 20' B, zonder rand		 x40
SXYQCPBHDC13 X20	Grijs	13' L x 20' B , overkapping zijluifel		 x92
SXYQCPBHDC20 X20	Grijs	20' L x 20' B , overkapping zijluifel		 x96

ASSEMBLY INSTRUCTIONS

Luifelmontage

1、Uitpakken en zeildoek en een bundel springkussens eruit halen ballen.



2. Vouw het product open en leg het neer plat op de standaard.

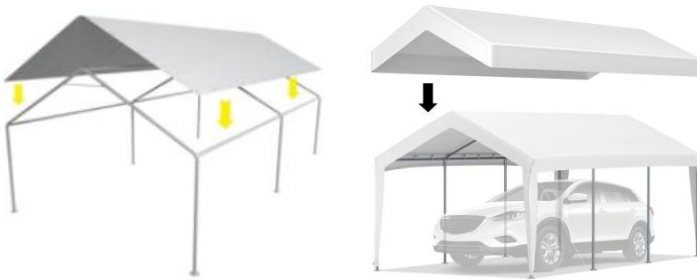

3. Geef de stuitende tetherballen door Door het daarvoor bestemde gat in het zeil en bevestig dit aan de metalen beugel. Bevestig vervolgens de haken aan de pootbeugels in de daarvoor bestemde gaten aan de voeten van de standaard.



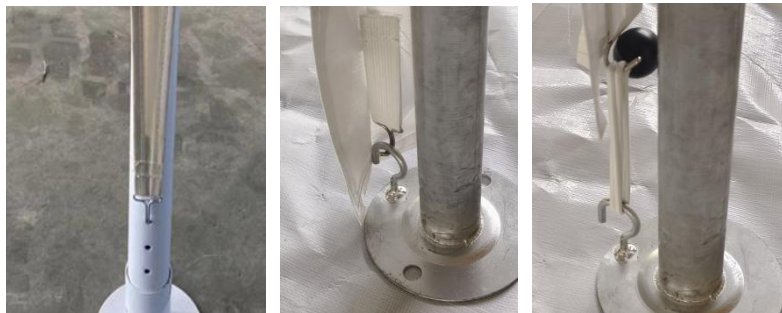

Voor het vasthaken kunt u de afbeelding hierboven raadplegen . Als de haakmaat niet voldoende is, kunt u ook een rekbal gebruiken.

Montage van de zijluifel

1. Pak het zeil uit en haal er een bundel stuiterende ballen uit .



2. Vouw het zeildoek open rond de beugel en steek de stuiterballen door de metalen gaten om het zeil aan de beugel te bevestigen.

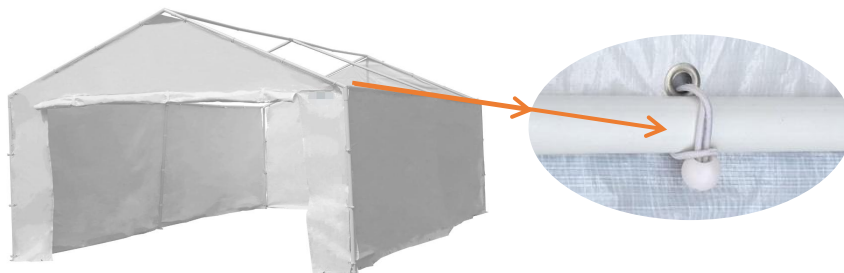

3. Het zeildoek dat als deur dient, wordt met klittenband aan de beugel bevestigd.



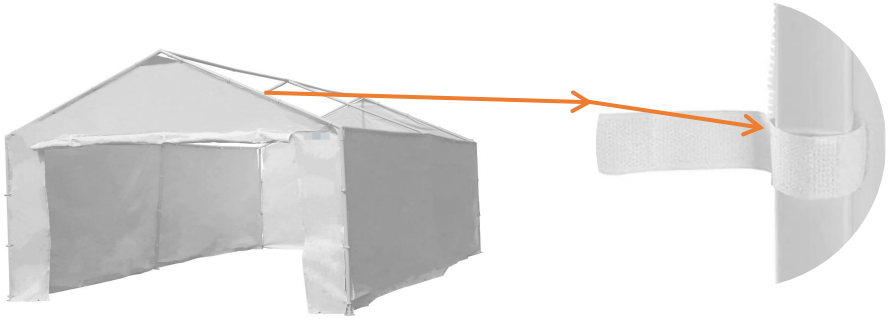

Fabrikant: Shanghaimuxinmuyeyouxiangongsi

Adres: Shuangchenglu 803nong11hao1602A-1609shi, baoshanqu, shanghai 200000 CN.

Geïmporteerd naar AUS: SIHAO PTY LTD. 1 ROKEVA
STREETEASTWOOD

NSW 2122 Australië

Geïmporteerd naar de VS: Sanven Technology Ltd. Suite 250, 9166
Anaheim

Plaats, Rancho Cucamonga, CA 91730

UK	REP
-----------	------------

YH CONSULTING LIMITED. C/O YH Consulting
Limited Office 147, Centurion House, London
Road, Staines-upon-Thames, Surrey, TW18 4AX

EC	REP
-----------	------------

E-CrossStu GmbH
Mainzer Landstr.69,
60329 Frankfurt am Main.



VEVOR

Affordable. Reliable. Home Improvement.

ZAMIENNA OSŁONA WIATY

VEVOR

Affordable. Reliable. Home Improvement.

CARPORT REPLACEMENT COVER

**MODELE: SXYQCPBB10X20 , SXYQCPBM10X20 , SXYQCPBH10X20 ,
SXYQCPBH12X20 , SXYQCPBH13X20 , SXYQCPBL10X20 ,
SXYQCPBM12X20,SXYQCPBB12X20**



MODELE: SXYQCPBBW10X20 ,SXYQCPBHW10X20



MODELE: SXYQCPBBCP10X20 , SXYQCPBHC12X20 , SXYQCPBHC13X20



**MODELE: SXYQCPBHDC10X20 , SXYQCPBMDC10X20,
SXYQCPBHDC12X20,
SXYQCPBHDC13X20,SXYQCPBHDC20X20**



This is the original instruction, please read all manual instructions carefully before operating. VEVOR reserves a clear interpretation of our user manual. The appearance of the product shall be subject to the product you received. Please forgive us that we won't inform you again if there are any technology or software updates on our product.



Ostrzeżenie: Aby zminimalizować ryzyko obrażeń, użytkownik powinien uważnie przeczytać instrukcję obsługi.

WARNING & PRECAUTIONS

OSTRZEŻENIE :

1. Unikaj kontaktu z ostrymi przedmiotami , aby zapobiec zarysowaniom .
2. Trzymaj wszystkie źródła ognia i ciepła z dala od materiałów plandekowych. Pod żadnym pozorem nie wolno używać źródeł otwartego ognia, urządzeń spalających paliwo lub urządzeń grzewczych pod lub w pobliżu.
3. Trzymaj w pobliżu gaśnicę lub wiadro z wodą .

OGŁOSZENIE :

1. Czyścić zimną wodą i miękką szczotką – nie używać mydła ani detergentu .
2. Nie wystawiać na działanie benzyny, oleju lub rozpuszczalników .











Potrzebni ludzie do montażu







PRODUCT DESCRIPTION











Materiał: wodoodporna, odporna na promieniowanie UV, tkana osłona polietylenowa

Innowacja technologiczna: spawanie gorącym powietrzem i spawanie metodą wytłaczania

Model	Kolor	Dostępne rozmiary wiat samochodowych	Produkt	Akcesoria
SXYQCPBB10X20	Biały	10' długości x 20' szerokości, daszek Z krawędzią		 x4 4
SXYQCPBM10X20	Beżowy			
SXYQCPBH10X20	Szary			
SXYQCPBBW10X20	Biały	10' długości x 20' szerokości, bez krawędzi		 x40
SXYQCPBBCP10X20	Biały	10' długości x 20' szerokości daszek boczny		 x40
SXYQCPBHDC10X20	Szary	10' długości x 20' szerokości, daszek daszek boczny		 x8 4
SXYQCPBH12X20	Szary	12' długości x 20' szerokości, daszek Z krawędzią		 x48

SXYQCPBHC12X 20	Szary	12' długości x 20' szerokości , daszek boczny		 x4 8
SXYQCPBH13X20	Szary	13' długości x 20' szerokości , daszek Z krawędzią		 x5 2
SXYQCPBHC13X 20	Szary	13' długości x 20' szerokości , daszek boczny		 50x

Model	Kolor	Dostępne rozmiary wiat samochodo- wych	Produkt	Akcesori- a
SXYQCPBL10X20	Zielony	10' długości x 20' szerokości, daszek Z krawędzią		 x4 4
SXYQCPBM12X20	Beżowy	12' dł. x 20' szer., daszek Z krawędzią		 x4 8
SXYQCPBB12X20	Biały			

SXYQCPBMDC10 X20	Beżowy	10' długości x 20' szerokości , daszek daszek boczny		 84
SXYQCPBHDC12 X20	Szary	12' dł. x 20' szer. , daszek daszek boczny		 88x
SXYQCPBHW10X 20	Szary	10' długości x 20' szerokości, bez krawędzi		 40x
SXYQCPBHDC13 X20	Szary	13' długości x 20' szerokości , daszek daszek boczny		 92x
SXYQCPBHDC20 X20	Szary	20' długości x 20' szerokości , daszek daszek boczny		 96x9 6

ASSEMBLY INSTRUCTIONS

Montaż baldachimu A

1. Rozpakuj i wyjmij plandekę oraz paczkę dmuchanych zabawek piłki.



2. Rozłóż produkt i połóż go płasko na górze stojaka.

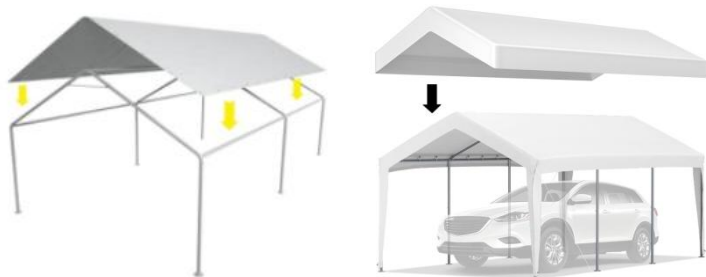

3. Podawaj sobie piłki na uwięzi przez zarezerwowany otwór w plandeece i podłącz go do metalowego wspornika. I zamontuj haki na nogach w odpowiednich otworach na nogach stojaka

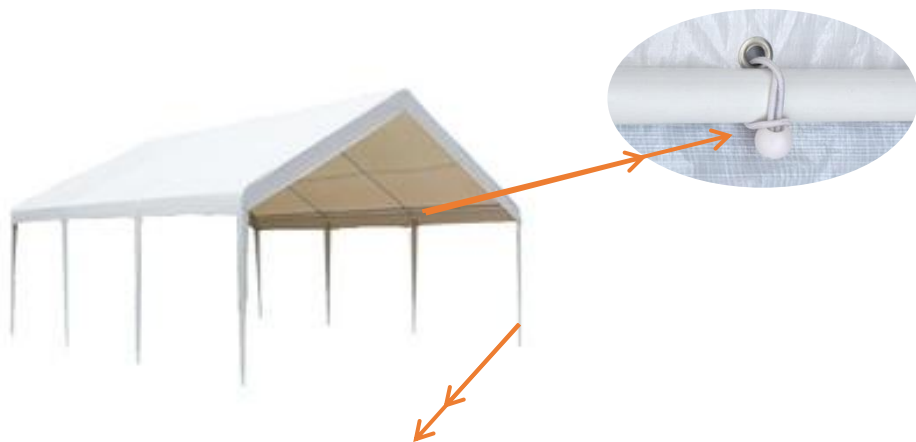



Możesz odnieść się do powyższego zdjęcia, aby uzyskać informacje na temat haczyka . Jeśli rozmiar haka jest niewystarczający, do połączenia można użyć rozciągliwej piłki.

Zestaw osłony bocznej A

1. Rozpakuj i wyjmij plandekę oraz paczkę piłek do odbijania .



2. Rozłóż plandekę wokół uchwytu i przełóż przez metalowe otwory piłki do odbijania, aby przymocować je do uchwytu.

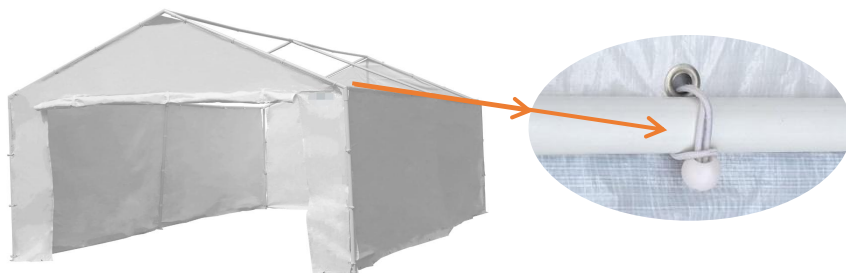

3. Plandeka służąca jako drzwi jest przymocowana do uchwytu za pomocą rzepu.



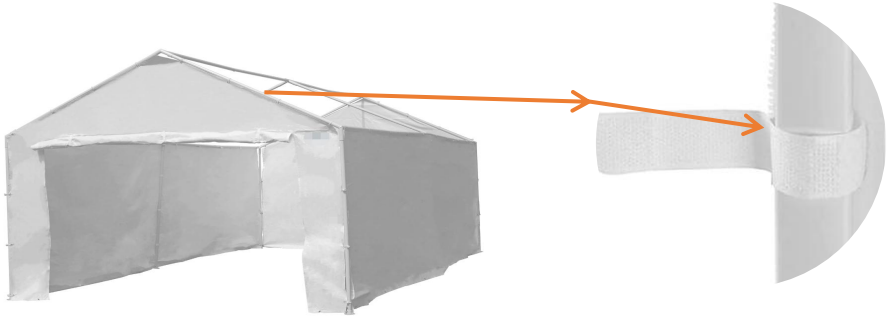

Producent: Shanghaimuxinmuyeyouxiangongsi

Adres: Shuangchenglu 803nong11hao1602A-1609shi, baoshanqu,
Szanghaj 200000 CN.

Importowane do AUS: SIHAO PTY LTD. 1 ROKEVA
STREETEASTWOOD
NSW 2122 Australia

Importowane do USA: Sanven Technology Ltd. Suite 250, 9166 Anaheim
Miejsce, Rancho Cucamonga, CA 91730

UK	REP
-----------	------------

YH CONSULTING LIMITED. C/O YH Consulting
Limited Office 147, Centurion House, London
Road, Staines-upon-Thames, Surrey, TW18 4AX

EC	REP
-----------	------------

E-CrossStu GmbH
Mainzer Landstr.69,
60329 Frankfurt am Main.



VEVOR

Affordable. Reliable. Home Improvement.

CARPORTENS RESERVSKYDD

VEVOR

Affordable. Reliable. Home Improvement.

CARPORT REPLACEMENT COVER

**MODELL: SXYQCPBB10X20 , SXYQCPBM10X20 , SXYQCPBH10X20 ,
SXYQCPBH12X20 , SXYQCPBH13X20 , SXYQCPBL10X20
SXYQCPBM12X20, SXYQCPBB12X20**



MODELL: SXYQCPBBW10X20 , SXYQCPBHW10X20



MODELL: SXYQCPBBCP10X20 , SXYQCPBHC12X20 , SXYQCPBHC13X20



**MODELL: SXYQCPBHDC10X20 , SXYQCPBMDC10X20, SXYQCPBHDC12X20
SXYQCPBHDC13X20,SXYQCPBHDC20X20**



This is the original instruction, please read all manual instructions carefully before operating. VEVOR reserves a clear interpretation of our user manual. The appearance of the product shall be subject to the product you received. Please forgive us that we won't inform you again if there are any technology or software updates on our product.



Varning – För att minska risken för skador måste användaren läsa instruktionsmanualen noggrant.

WARNING & PRECAUTIONS

VARNING :

1. Undvik kontakt med vassa föremål för att förhindra repor .
2. Håll alla lågor och värmekällor borta från presenningsmaterialet. Använd under inga omständigheter några öppna lågor, bränsleförbränningsanordningar eller värmeanordningar under eller i närheten.
3. Ha en brandsläckare eller vattenhink i närheten .

MEDDELANDE :

1. Rengör med kallt vatten och en mjuk borste – använd inte tvål eller rengöringsmedel.
2. Utsätt inte för bensin, olja eller lösningsmedel .

Personal behövs för installation

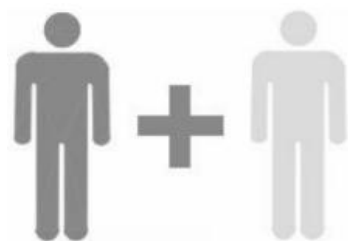

















PRODUCT DESCRIPTION















Material: vattentätt UV-vävt polyetenöverdrag

Teknologisk innovation: Varmlufts- och extruderingssvetsning

Modell	Färg	Tillämpliga carportstorle kar	Produkt	Tillbehör
--------	------	-------------------------------------	---------	-----------

SXYQCPBB10X20	Vit	10' L x 20' B, tak Med kant		 x4 4
SXYQCPBM10X20	Beige			
SXYQCPBH10X20	Grå			
SXYQCPBBW10X 20	Vit	10' L x 20' B, utan kant		 x40
SXYQCPBBCP10 X20	Vit	10' L x 20' B sidotak		 x40
SXYQCPBHDC10 X20	Grå	10' L x 20' B tak sidotak		 x8 4
SXYQCPBH12X20	Grå	3,6 m L x 6,2 m B tak Med kant		 x48
SXYQCPBHC12X 20	Grå	3,6 m L x 6,2 m B sidotak		 4x8
SXYQCPBH13X20	Grå	13' L x 20' B tak Med kant		 x5 2
SXYQCPBHC13X 20	Grå	13' L x 20' B sidotak		 50

Modell	Färg	Tillämpliga	Produkt	Tillbehör
--------	------	-------------	---------	-----------

		carportstorle kar		
SXYQCPBL10X20	Grön	10' L x 20' B, tak Med kant		 x4 4
SXYQCPBM12X20	Beige	1 2 ' L x 20' B, tak Med kant		 4x8
SXYQCPBB12X20	Vit			
SXYQCPBMDC10 X20	Beige	10' L x 20' B tak sidotak		 x84
SXYQCPBHDC12 X20	Grå	1 2 ' L x 20' B tak sidotak		 x88
SXYQCPBHW10X 20	Grå	10' L x 20' B, utan kant		 40 st
SXYQCPBHDC13 X20	Grå	1 3 ' L x 20' B tak sidotak		 x92
SXYQCPBHDC20 X20	Grå	20 ' L x 20' B tak sidotak		 x96

ASSEMBLY INSTRUCTIONS

Kapellmontering

1、 Packa upp och ta ut presenning och ett knippe studs-material bollar.



2. Vik ut produkten och lägg den platt ovanpå stativet.

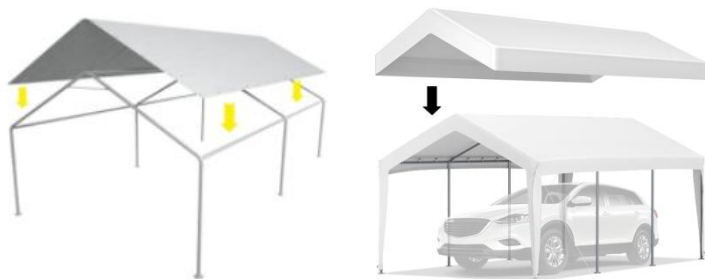

3. Passera de studsande tetherbollarna genom det reserverade hålet i presenningen och anslut den till metallfästet. Och montera krokarna på benstöden i lämpliga hål på stativets fötter

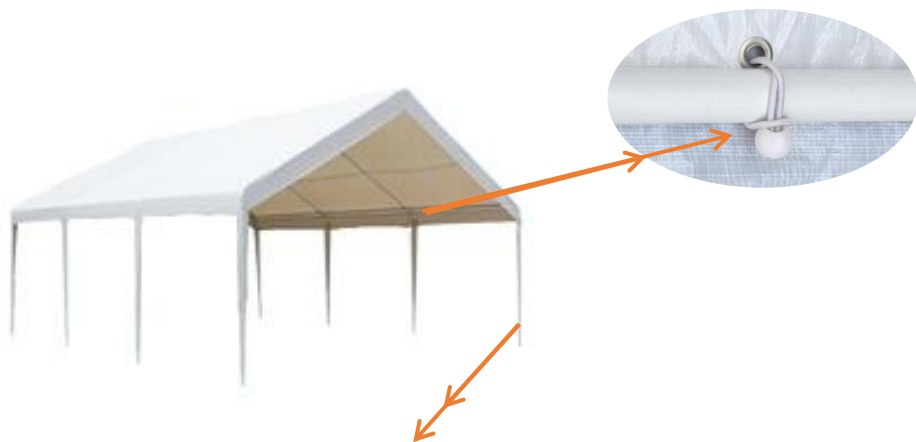



Du kan se bilden ovan för krokning . När krokens storlek inte är tillräcklig kan en stretchboll också användas för koppling.

Sidotakmontering

1. Packa upp och ta ut presenningen och ett knippe studsbollar .



2. Vik ut presenningen runt fästet och för in studsande snörebollar genom metallhålen för att fästa den vid fästet.

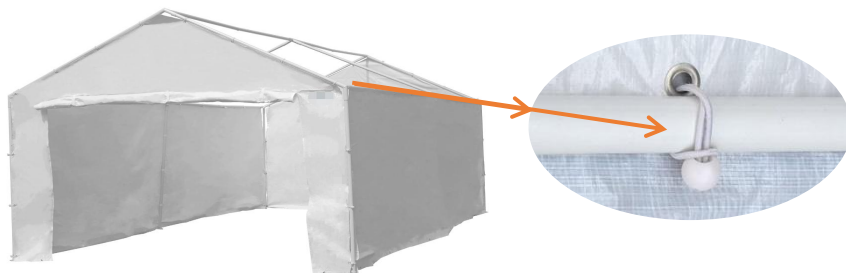

3. Presenningen som fungerar som dörr är fäst vid fästet med kardborreband.



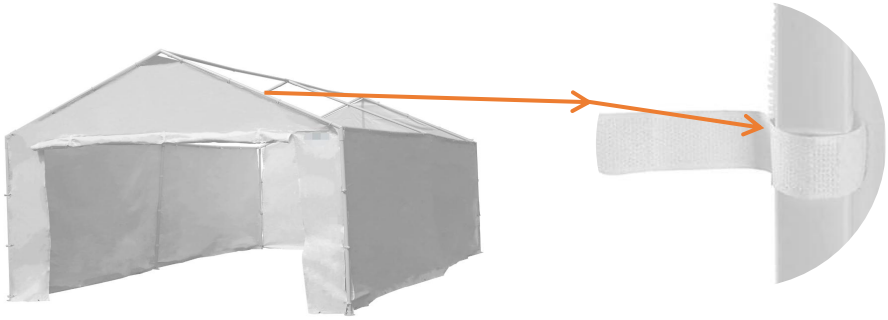

Tillverkare: Shanghaimuxinmuyeyouxiangongsi

Adress: Shuangchenglu 803nong11hao1602A-1609shi, baoshanqu, Shanghai 200 000 kanadensiska republiken.

Importerad till Australien: SIHAO PTY LTD. 1 ROKEVA

STREETEASTWOOD

NSW 2122 Australien

Importerad till USA: Sanven Technology Ltd. Suite 250, 9166 Anaheim Plats, Rancho Cucamonga, Kalifornien 91730

UK	REP
-----------	------------

YH CONSULTING LIMITED. C/O YH Consulting Limited Office 147, Centurion House, London Road, Staines-upon-Thames, Surrey, TW18 4AX

EC	REP
-----------	------------

E-CrossStu GmbH
Mainzer Landstr.69,
60329 Frankfurt am Main.

