

HYUNDAI
POWER PRODUCTS

33cm Electric Lawn Mower & 250W Grass Trimmer

HYM3313EGT

Instruction Manual



GENUINE PRODUCT OF
HYUNDAI CORPORATION

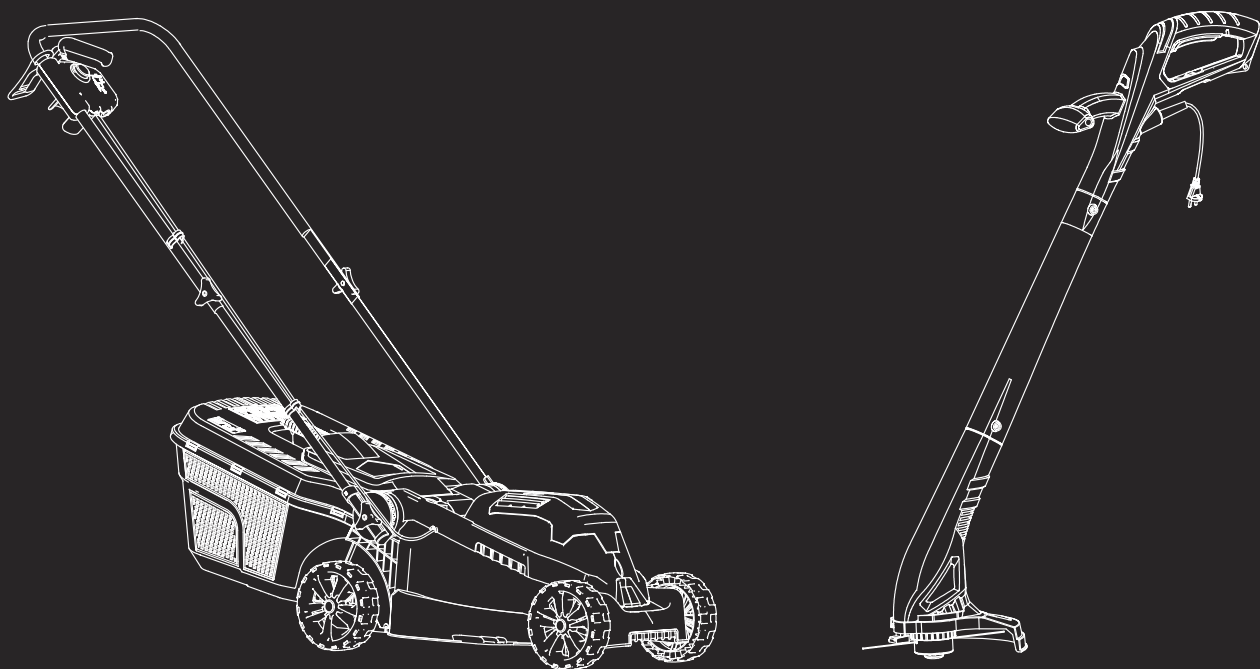

WARNING: Read the instructions carefully before use.



Contents

Introduction.....	3	Grass Trimmer Instruction Manual.....	34-68
Lawn Mower Instruction Manual.....	4-33	Safety Information.....	35-44
Lawn Mower Manual Overview.....	4	Features/In The Box.....	45
Safety Information.....	5-14	Assembly.....	46-50
Unboxing.....	15	Connect Trimmer Shaft to Main Unit..	46-47
Instruction Manual Overview.....	15	Safety Guard to Motor Head.....	48
Features.....	16	Connecting Cable.....	49
Assembly.....	17-21	Cable Holder On Handle.....	50
Assembly Overview.....	17	Operation.....	51-53
Lower Handles.....	17	Tips For Use.....	51
Upper Handle.....	18	Before Starting.....	51
Handle Position Adjustment.....	18	Automatic Line Feed.....	52
Grass Collection Box.....	19	Starting.....	53
Power Cable.....	20	Stopping.....	53
Cable Strain Reliever.....	20	Maintenance & Care.....	54-58
Cable Clips.....	21	Replacement Parts/Spares.....	59
Operation.....	22-24	Technical Data.....	60
Starting.....	22	Recycling And Disposal.....	61
Stopping.....	22	Declaration Of Conformity.....	62
Mower Deck Grass Fins.....	22	Notes.....	63-64
Cutting Height Adjustment.....	23	Useful Information.....	65
Grass Indicator.....	24	Our YouTube Channel.....	65
Collection Bag Emptying.....	24	Warranty.....	65
Lawn Care.....	25	Manual Updates.....	65
Technical Data.....	26-30	Returning Your Product.....	65
Maintenance & Care.....	31-32	Leaving A Review.....	65
Declaration Of Conformity.....	33	Ordering Spare Parts.....	65
		Product Record.....	66
		Contact Us.....	67

Introduction

Thank You For Purchasing Your HYUNDAI Product

We work very hard to give all of our customers the best possible service. If you have any problems, before leaving negative feedback, please contact us to give us a chance to resolve the issue. We would be delighted if you left us positive feedback! Thank you for purchasing this product.

Important!



WARNING: READ THE INSTRUCTION BOOKLET THOROUGHLY BEFORE USING THE MACHINE. Keep for future reference and pass it on if the machine is loaned or sold to another user.

This manual has been produced by Hyundai Power Products and should be kept with the product. Please read and understand these instructions before you use your product. Failure to do this may result in personal injury or damage to the product.

The safety precautions and warnings are to ensure your safety and protect you from harm or damage to the product.

The information contained in this manual was accurate at the time of production, however HYUNDAI Power Products may make modifications to the product without notification.

Lawn Mower – Instruction Manual

Instruction Manual Overview

This product is comprised of two separate items, and, as such, this manual contains instructions and diagrams which are only relevant to each respective item.

Only follow the instructions and guidance relevant to the item you are working on.

Electric Lawn Mower HYM3313E

Instruction Manual

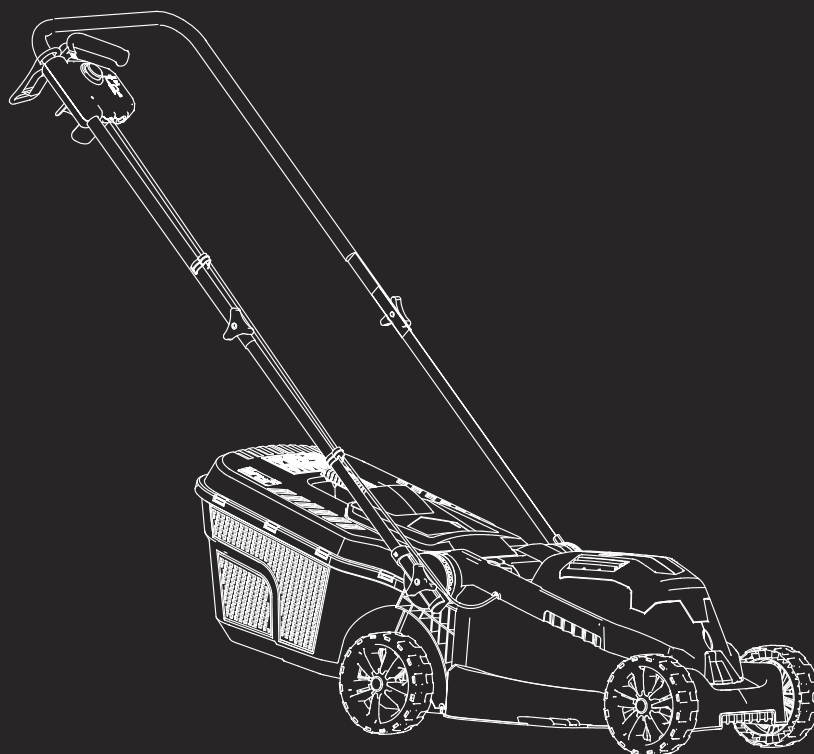

Safety Information

Understand Your Machine

- **WARNING!** You must read these instructions carefully before operating the machine. Make sure that you are familiar with the controls and properly operate the machine. You must learn how to stop the machine quickly. If you do not follow the warnings and instructions, it may result in fire and/or serious injury. Make sure to save all warnings and instructions for future reference.
- Read this manual and labels affixed to the machine to understand its limitations and potential hazards.
- Be thoroughly familiar with the controls and their proper operation. Know how to stop the machine and disengage the controls quickly.
- If the unit is to be used by someone other than original purchaser, or is to be loaned, rented, or sold, always provide this manual and any needed safety training before operation. The user can prevent and is responsible for accidents or injuries that may occur to themselves, to other people, or to property.
- Do not force the machine beyond its limits. Use the correct machine for your application.
- Know how to stop the machine quickly in case of emergency. Understand the use of all controls.

Personal Safety

- **ALL MAINTENANCE** other than that listed in this manual, should be carried out by professionally trained and certified personnel.
- **WARNING!** Never allow children or people unfamiliar with these instructions to use the product. Local regulations can restrict the minimum age of the operator.
- Keep children, pets, and other people not using the unit away from the work area. Be alert and shut off the unit if anyone enters work area. Keep children under the watchful care of a responsible adult.
- Stay alert, watch what you are doing and use common sense when operating the machine. Never operate the machine when unwell or tired, or if you have taken alcohol, medicine, drugs or any substances which may slow your reflexes and compromise judgment. A moment of inattention while operating the machine may result in serious personal injury.
- Appropriate Personal Protective Equipment (PPE), **MUST** be worn at all times when operating or repairing the machine. Always wear anti-slip and resistant work footwear and long trousers while using the machine. Do not use the machine when barefoot, wearing sandals or similar lightweight footwear. Do not wear chains, bracelets or clothing that is loose fitting or hanging ties or cords. Tie long hair back. Always wear protective earplugs. Loose clothes, jewellery, or long hair can be caught in moving parts. Protect eyes, face, and head from objects that may be thrown from the unit. Always wear safety goggles or safety glasses with side shields when operating.

Safety Information

Personal Safety (Continued)

- Always keep hands and feet away from all moving parts during operation. Moving parts can cut or crush body parts.
- Always keep hands and feet away from all pinch points.
- Do not touch parts that might be hot from operation. Allow parts to cool before attempting to maintain, adjust, or service.
- Do not overreach. Keep proper footing and balance at all times. This enables better control of the machine in unexpected situations. Extending your body too far can result in a loss of balance and you may fall which will result in injury.
- Never place any part of your body where it would be in danger if movement should occur during assembly, installation, and operation, maintenance, repairing or moving.
- Start the machine carefully according to instructions and with feet away from the moving parts.
- Do not place your hands or feet near or under rotating parts. Keep away from any discharge openings.
- Keep in mind that the operator or user is responsible for accidents, hazards or unexpected events involving the machine that occur to other people or their property. It is the responsibility of the user to assess the potential risk of the area where work is being carried out. The operator or user must take all necessary precautions to ensure their own safety and that of others, especially on slopes or rough, slippery and unstable ground.
- Always keep a safe distance from the rotary blade, given by the length of the handle.

Inspect Your Machine

- Check your machine before starting it. Keep guards in place and in working order. Make sure all nuts, bolts, etc., are securely tightened.
- You must check the general condition of the machine before use.
- Never operate the machine when it is in need of repair or is in poor mechanical condition. Replace damaged, missing, or failed parts before using it. Do not use the machine if the machine's switch does not turn off when running.

Safety Information

Work Area

- Make sure you thoroughly inspect the entire work area and remove all objects and anything that could be thrown by the machine or could damage the machine (branches, stones, wire, toys, etc.). Attempting to clear the work area whilst using the machine will reduce your concentration and creates a trip hazard. Any liquid spilled on the floor may result in you slipping.
- You must only work in daylight or with good artificial light in good visibility conditions. Keep people, children and animals away from the working area. Distractions can cause you to lose control.
- Operate on flat, level ground.
- Use the unit in dry conditions only. Protect it from rain and moisture. If there has been heavy rain on the working site, wait until the ground has dried up.
- Never park the machine in a place with unstable ground which could give way.
- You must pay special attention when approaching obstacles that could compromise visibility.
- When mowing on slopes, you must mow across the slope and not up and down it. When changing direction, you need to be careful that the wheels do not hit any obstacles (such as roots, branches, stones, etc.) that can cause the lawnmower to slide sideways or make you lose control of it. Make sure on slopes you have a steady foothold.
- The lawnmower must never be used on slopes of over 20°, regardless of the mowing direction.
- You must be careful near ravines, ditches or embankments.
- Exercise extreme caution when operating on or crossing gravel drives, walks, or roads. Stay alert for hidden hazards or traffic.
- Find and locate all fixed objects in the ground, such as sprinkler systems, poles, water valves, bases for washing lines etc. Make sure that you check for hidden electrical cables or similar on the surface of the lawn. ALWAYS run the machine around these objects. NEVER intentionally run the machine over foreign objects.
- Pay the utmost attention when working on frozen ground as the machine may tend to skid.
- Do not work in the rain or when there is a thunderstorm or lightning risk. If there is bad weather conditions, do not use the machine.
- Never run over gravel while the motor is running. There is a risk of being hit by stones.
- Switch the lawnmower off before tilting or transporting it, e.g. from/to lawn or over paths

Safety Information

During Use

- Always hold the unit with both hands when operating. Keep a firm grip on the handlebars.
- Be aware that the machine may unexpectedly bounce upward or jump forward if the machine should strike buried obstacles such as large rocks or roots. Maintain a safe distance as provided by the handle frame.
- Walk, never run with the machine.
- Use extreme caution when in reverse or pulling the machine towards you.
- Do not operate the machine in confined areas where there may be a risk of trapping the operator between the machine and another object.
- Be very careful when pulling the machine toward you. You must look behind you to make sure there are no obstacles.
- Do not allow the machine to pull you along, you must walk and never run..
- **WARNING!** If something breaks or an accident happens whilst working, you must turn off the machine immediately and move the machine away to prevent further damage. If an accident happens with injuries or third parties are injured, carry out the first aid measures most suitable for the situation immediately and contact the medical authorities for any necessary health care. Carefully remove any debris that might cause damage or harm persons or animals should it not be seen.
- Do not switch on the motor until your feet are at a safe distance from the blade. Be careful and never reach into the rotating blade.
- Ensure that you have a firm footing and mow slowly. Be particularly careful when changing direction. There is a risk of tripping!
- The excessive speed of movement or the absence of maintenance have a significant influence on noise emissions and vibrations. It is necessary to take preventive steps to eliminate possible damage due to high levels of noise and stress from vibration. You must maintain the machine well, wear ear protection and take breaks from working.
- Never open the discharge flap while the motor is running.
- Do not tilt the lawnmower when switching on the motor. If the lawnmower is running, do not lift whilst the motor is running either.
- Stop the machine and allow all moving parts stop before removing the grass collection box or adjusting the cutting height.
- After striking a foreign object, you must inspect the machine for damage and make repairs before using it again. Any inspection or repairs must be carried out with the machine unplugged.
- After emptying the grass catcher, carefully re-attach it and ensure that the grass catcher is attached securely to the lawnmower.
- Do not switch on the unit if there are persons (particularly children) or animals in the immediate vicinity. Ensure that children do not play with the unit. Stop working if you notice that persons (particularly children) or pets are nearby. When stopping work, never leave the unit unattended and keep it in a safe place.
- Prevent unintentional starting. Ensure the switch is in the off-position before connecting to power source and/or battery pack, picking up or carrying the tool. Carrying power tools with your finger on the switch invites accidents

Always ensure the machine is unplugged from the power source and all moving parts are stationary before:

- Checking or working on the machine.
- Cleaning the machine.
- Before clearing blockages or unclogging the discharge chute.
- When lifting or transporting the machine.
- Whenever you leave the machine unattended.
- If the unit starts vibrating excessively.

Safety Information

Vibrations (Where Applicable)

- Prolonged use of hand held (operated) machines will cause the user to feel the effects of/from vibrations. These vibrations can lead to white finger (Raynaud's phenomenon) or carpal tunnel syndrome. This condition reduces the ability of the hand to feel and regulate temperature, causing numbness and heat sensations and may cause nerve damage and circulatory tissue death.
- Not all factors that lead to white finger disease are known, but cold weather, smoking and other diseases that affect blood vessels and blood circulation as well as large and long-lasting impact of shocks are considered factors in the formation of white finger. Note the following to reduce the risk of white finger and carpal tunnel syndrome;
 - Wear gloves and keep your hands warm.
 - Take regular breaks.
 - All of the above precautions may help reduce the risk of white finger disease but not rule out the carpal tunnel syndrome. Long-term and regular users are therefore recommended to observe the condition of your hands and fingers. Seek medical attention immediately if any of the above symptoms should occur.

Noise (Where Applicable)

- The operating noise of the machine can damage your hearing. When wearing protection such as earplugs or ear defenders to protect your hearing. Long-term and regular users are advised to have hearing checked regularly. Be especially vigilant and cautious when wearing ear protection because your ability to hear alarm warnings will be reduced.
- Noise emissions for this equipment is unavoidable. Carry out noisy work at approved times and for certain periods. Limit the working time to a minimum. For your personal protection and protection of people working nearby it is also advisable for them to wear hearing protection.



- See Certificate of Conformity section for Outdoor Noise declaration of conformity.

Residual Risks

Even when tool is used as prescribed it is not possible to eliminate all residual risk factors. The following hazards may arise in connection with the tool's construction and design:

1. Damage to lungs if an effective dust mask is not worn.
2. Damage to hearing if effective hearing protection is not worn.

Health defects resulting from vibration emission if the power tool is being used over longer period of time or not adequately managed and properly maintained.

⚠ WARNING! This machine produces an electromagnetic field during operation. This field may under some circumstances interfere with active or passive medical implants. To reduce the risk of serious or fatal injury, we recommend persons with medical implants to consult their physician and the medical implant manufacturer before operating this machine.

Safety Information

Electricity (Where Applicable)

DANGER : ELECTRICITY CAN KILL – NEVER WORK ON LIVE / ENERGISED EQUIPMENT.



- Prior to carrying out any maintenance work you **MUST** identify electrical isolation methods and isolate all electrical supplies.

Prior to use and with all electrical supplies isolated, you **MUST** check all electrical cables, plugs and connectors for the following;

- Are intact and have no signs of damage, to include but not limited to bare wires, chaffing, cuts and loose wiring.
- If there are any signs of damage, the damaged item **MUST** be taken out of service until the damage has been repaired by an electrically competent person.
- All trailing cables should be routed so as not to cause any kind of trip hazard.
- **NEVER** work on or near electricity with wet hands, wet clothing and wet gloves.
- Power tools plug must match the outlet. Never modify the plug in any way. **DO NOT** use any adapter plugs with earthed (grounded) power tools. Unmodified plugs and matching outlets will reduce risk of electric shock.
- **DO NOT** expose this power tool to rain or wet conditions. Water entering a power tool will increase the risk of electric shock. **DO NOT** abuse the power cord. Never use the cord for carrying, pulling or unplugging the power tool. Keep the cord away from heat, oil and sharp edges or moving parts. Damaged or entangled cords increase the risk of electric shock. When operating a power tool, use an extension cord suitable for outdoor use. Use of a cord suitable for outdoor use reduces the risk of electric shock.
- **IMPORTANT:** Make sure that the electric circuit is fused, and that the power, voltage and frequency of the motor is supported by your mains supply. Also, make sure that your power supply is earthed. Connect your machine to earth. Never open the ON/OFF switchbox. However, if it should become necessary to do so, contact a qualified electrician. Make sure that you will never touch live contacts, specifically when you plug or unplug your machine. This machine and its power cord must never get into contact with water.
- Avoid body contact with earthed or grounded surfaces such as pipes, radiators, ranges and refrigerators. There is an increased risk of electric shock if your body is earthed or grounded.
- To prevent electric shock, use only with an extension cord suitable for outdoor use. For additional protection, the installation of a residual current device (RCD) having a rated residual operating current not exceeding 30mA is advisable.
- Before use, check that the extension cord is in good condition. When using an extension cord, make sure to use one heavy enough to carry the current your product will draw. An undersized cord will cause a drop in line voltage resulting in loss of power and overheating.
- Do not allow any part of the machine to make contact with water while it is in operation. If the appliance becomes wet while turned off, wipe dry before starting. Do not touch the appliance or its plug with wet hands or while standing in water. Wearing rubber boots offers some protection.
- Before use, check the supply and extension cord for signs of damage or aging. If the cord becomes damaged during use, disconnect the cord from the supply immediately. If the supply cord is damaged, it must be replaced by the manufacturer or a qualified person in order to avoid a hazard.

Safety Information

Double-Insulated Appliances

In a double-insulated appliance, two systems of insulation are provided instead of grounding. No grounding means that it is already provided on a double-insulated appliance. Servicing a double-insulated appliance requires extreme care and knowledge of the system, and should be performed only by qualified service personnel. Replacement parts for a double-insulated appliance must be identical to the parts they replace.

Lawnmower Specific Safety

There's specific hazards and danger when using a lawn mower. These hazards are a result of using the machine within it's intended use. Additional hazards can result if the machine is not used correctly. These are but not limited to:

- **Moving Blade Hazard** – Due to the nature of the lawn mower, a rotational blade is part of it's operation. The user should NEVER tilt the machine during use, this will increase the chance of harm or injury.
- **Projectile Hazard** – Because of the high speed of the mower blade, the machine can propel small objects like rocks, sticks, toys and other debris which can be found in a garden environment. It's important to wear correct PPE to protect the body from these potential projectiles. You must keep this in mind when operating the machine with other persons present. They must be a safe distance away from the machine.
- **Trip & Fall Hazard** – Operating a lawn mower requires stability and balance during operation. Not every lawn is perfectly flat, so it's important to be aware of the terrain as pushing a lawn mower can lead to losing balance. Trips and falls can lead to fractures, sprains and even head injuries. To prevent this wear suitable footwear, operate at a comfortable speed and be mindful of slippery and uneven surfaces.
- **Physical Competency** – A push mower requires a level of strength and co-ordination to maneuverer and control effectively. Insufficient capability can lead to accidents such as losing control of the mower or running over obstacles.

Safety Information

Personal Protective Equipment

Appropriate Personal Protective Equipment (PPE), MUST be worn at all times when operating or repairing the machine. No protective equipment can ensure 100% protection.

When selecting PPE, make sure it's CE marked and it suits the user in terms of size, fit, etc. If more than one item of PPE is worn at the same time, make sure they can be used together, e.g. wearing safety glasses may disturb the seal of a respirator, causing air leaks.



Hand Protection Must Be Worn

Protective electrically non-conductive gloves are highly recommended when working.



Foot Protection Must Be Worn

Non-skid heavy duty footwear are highly recommended when working.



Hearing Protection Must Be Worn

Suitable safety hearing protection is recommended.



Eye Protection Must Be Worn

Always wear safety glasses/goggles and/or face shields. Everyday eyeglasses have only impact resistant lenses; they are not safety glasses/goggles.



Protective Clothing Must Be Worn

Do not wear loose clothing, gloves, scarfs, neckties or jewellery (rings, wrist watches), which can be caught in moving parts.



Head Protection Must Be Worn

Wear a safety helmet with a safety visor.













Face Shield Must Be Worn

Wear a face shield to protect your face.

Safety Information

! Symbols On The Machine

We have provided safety messages in this manual and on the machine. This information alerts you to potential hazards that could hurt you or others. Please read these messages carefully. However, we may not have listed all of the possible hazards, you must also use your own judgement.

Symbol	Description	Symbol	Description
	Safety alert – Indicates a precaution, a warning or a danger.		Keep away from the danger area.
	Read operator's manual.		Keep all bystanders and animals at least 15 metres away from the machine during operation. If approached, stop the machine immediately.
	Hand protection must be worn		Do not expose the product to rain or wet conditions.
	Sharp blades can cut limbs.		Keep hands and feet away from cutting parts.
	This product should not be disposed of in domestic waste. Please contact your local recycling centre for disposal service.		This product complies with the European directives and an evaluation method of conformity for these directives was done
	The UKCA (UK Conformity Assessed) marking is a UK product marking that is required for goods being placed on the market in Great Britain (England, Wales and Scotland).		

Safety Information

Intended Use

The HYM3313E is an electric lawnmower from HYUNDAI. The HYM3313E has a cutting width of 330mm and is powered by a 1300W Motor

The HYM3313E is a garden tool and precisely a pedestrian controlled lawnmower. The machine is essentially composed of a motor which drives a blade enclosed in a casing, equipped with wheels and a handle. The operator is able to operate the machine and use the main controls, always staying behind the handle at a safe distance from the rotating blade.

If the operator leaves the machine, the machine will stop within a few seconds.

The lawnmower is manufactured according to the latest safety requirements. These include a blade brake that stops the machine and blade when you let go of the OPC lever. Every precaution is only effective when it is followed exactly.

Intended Use

This machine was designed and manufactured for cutting and collecting grass in gardens and grassy areas, in areas in proportion to its cutting capacity, controlled by a pedestrian operator.

User Types

This machine is intended for use by consumers, i.e. non professional operators. The machine is intended for "DIY" and domestic use only.

This garden tool is not intended for use by persons (including children) with reduced physical, sensory or mental capabilities, or lack of experience and knowledge, unless they have been given supervision or instruction concerning use of the machine by a person responsible for their safety. Never allow children or people unfamiliar with these instructions to use the garden tool.

Supervise children. This will ensure that children do not play with the unit.

Any other use is not as intended. Improper use is not covered by the warranty and the manufacturer will reject any liability. The user is liable for all injuries to third parties and damage to their property. Operate the unit only in the technical condition as stipulated and delivered by the manufacturer. Arbitrary changes to the unit will exclude the manufacturer from any liability for resulting injury and/or damage.

Improper Use

Any other usage not in keeping with the above mentioned ones may be hazardous and harm persons and/or damage things. Examples of improper use may include, but are not limited to:

- transporting people, children or animals on the machine
- letting yourself be transported by the machine
- using the machine to tow or push loads
- using the machine for leaf or debris collection
- using the machine to trim hedges, or cutting anything other than grass
- use of the machine by more than one person
- using the blade on surfaces other than grass

Unboxing

! WARNING : Unboxing and assembling the machine should be done on a flat, surface with enough room. Disposal of the packaging should be done in accordance with the local regulations in force.

! WARNING : Some of the packaging material may be harmful to children. Keep out of reach of children.

1. Carefully remove the product from the packaging and examine it for any sign of damage caused during shipping.
2. Lay the contents out and check them. If any part is damaged or missing, you must not use the machine. Contact HYUNDAI POWER PRODUCTS immediately.
3. You must keep the packaging material in case the machine needs to be returned or repaired.
4. Ensure that you have all the accessories and tools you need for assembly and operation including the suitable personal protective equipment.

We recommend that you fill out the information in the 'Product Record' section. If you need to contact an authorised dealer or customer service, you may need to provide this information.

Features (Lawn Mower)

*Not To Scale

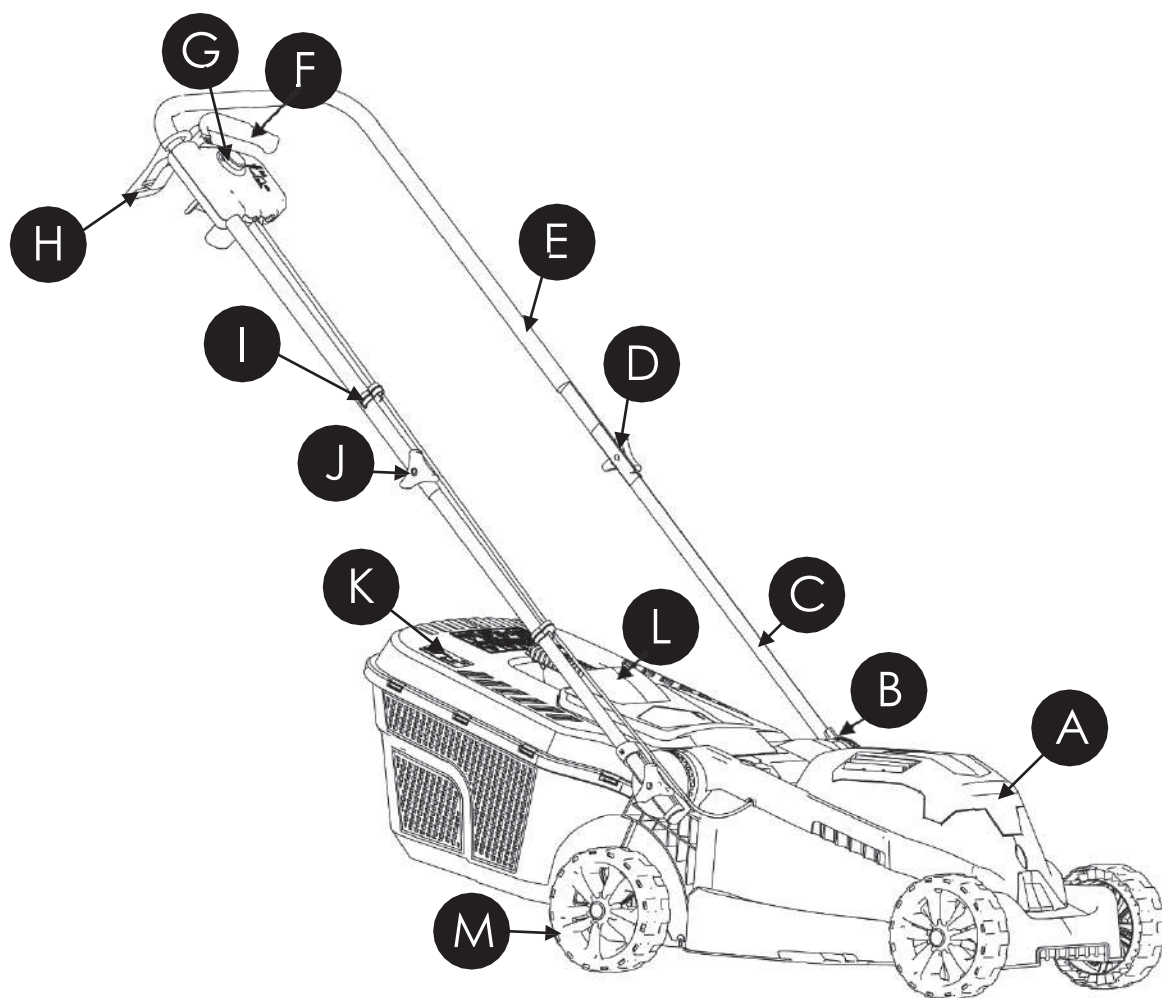

- A. Main Body** – The main deck of the machine, this houses the motor and the blade
- B. Handle Position Adjustment Indicator** – Shows Handle current angle
- C. Lower Handle**
- D. Bolt**
- E. Upper Handle**
- F. Operator Presence Control Lever** – A lever put into place for safety, to ensure no accidental operation
- G. On/Off safety button**
- H. Cable Strain Reliever** – helps support the power cable/
- I. Cable Clip**
- J. Wing Nut**
- K. Grass Level Indicator Flap** – When the grass collection box is full, the indicator flap will be closed.
- L. Grass Collection Box**
- M. Wheel**

Assembly

HYM3313E Assembly – Safety

⚠ CAUTION - This guide is meant to serve as a quick reference for operating your HYUNDAI machine. We always advise reading the manual in full before operation.

⚠ NOTE - Images may vary depending on model.

⚠ WARNING - Before assembly ensure the machine isn't plugged into a power source to avoid accidental starting.

HYM3313E Assembly – Lower Handles

1. Loosen the wingnut by turning it anti-clockwise. Do not remove the wingnut.
2. Move the lower handle toward the rear of the machine, and then tighten the wingnut by turning it clockwise.
3. Repeat on both sides.

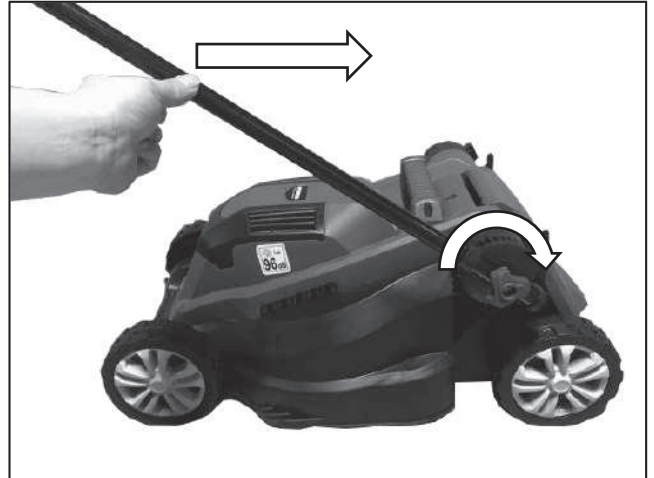

Assembly

HYM3313E Assembly – Upper Handle

1. Place the Cable Reliever on **Upper Handle (E)** as shown below.
2. Secure the **Upper handles (E)** by placing a **Bolt (D)** through both the lower and upper handles. Secure with a **Wing-Nut (J)**.
3. Your machine should look the same as below.

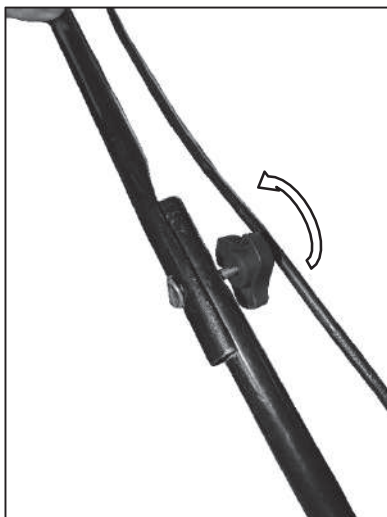
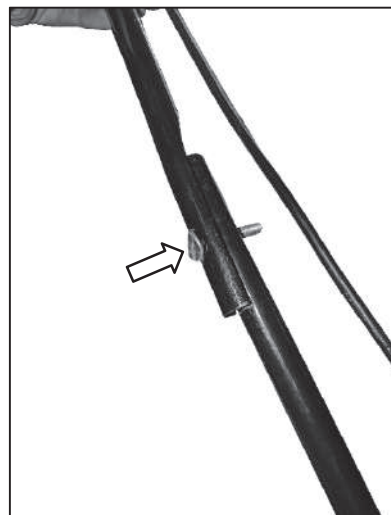
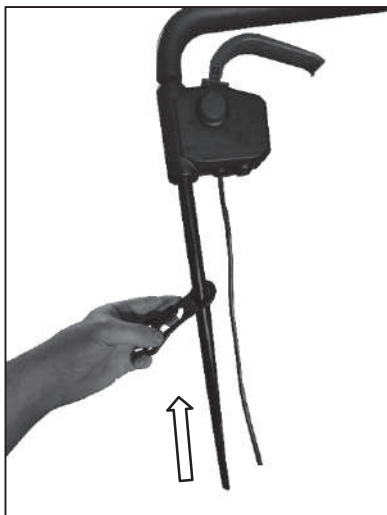

HYM3313E Handle Position Adjustment

The handles have 3 available positions to aid operator comfort.

To select the height simply slacken off the wing-nut attached to lower handles. This will allow you move the locator out and select another position.



Assembly

HYM3313E Assembly – Grass Collection Box

1. Place the handle into location at the top **Grass Collection box (L)**. Turn over and secure by installing the screws included.
2. Combine the top and bottom halves of the Grass Collection box. There's clips around the edges of both which need to be clicked into place.
3. The Grass Collection is fitted to the hooks at the rear of the machine. Lift the Rear Discharge Flap and then hook on the Grass Collection box.

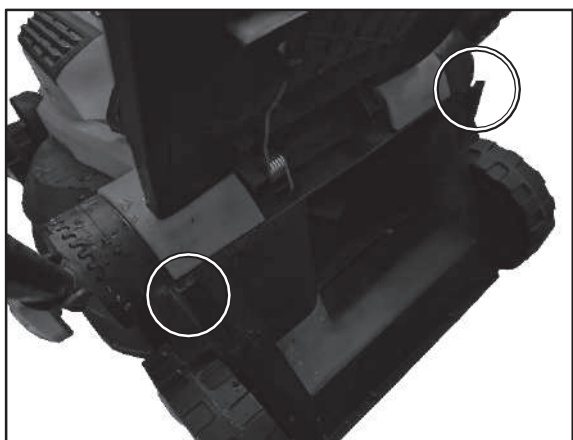
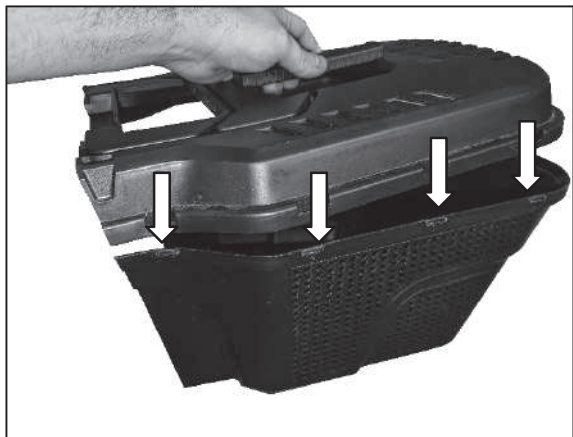
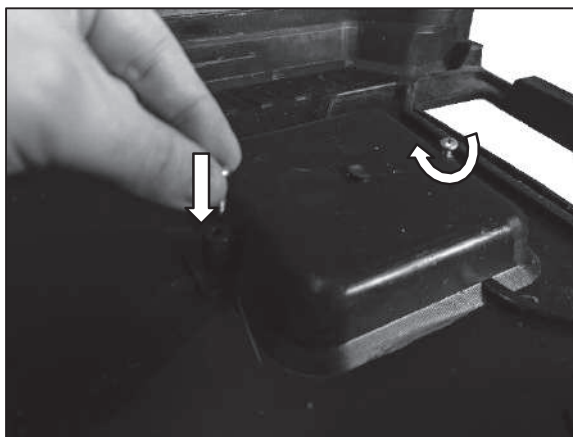
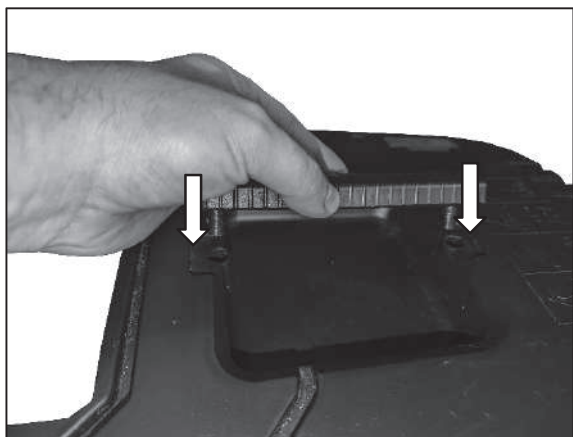

Assembly

HYM3313E Assembly – Power Cable

This machine comes equipped with a removable power cable. Simply push the power cable into place as shown below.



HYM3313E Assembly – Cable Strain Reliever

⚠ CAUTION – To safely operate this machine you must use the cable strain reliever. This will prevent the power cable from detaching during operation

Simply create a loop in the power cable and pass it through the lower hole of the cable strain reliever. Then pass the loop over the hook and pull slightly to secure into place.



Assembly

HYM3313E Assembly – Cable Clips

Attach the cable onto the right-hand **Lower Handle (C)** using the **Cable Clips (I)** provided. This will keep the cable secure and tight to the machine

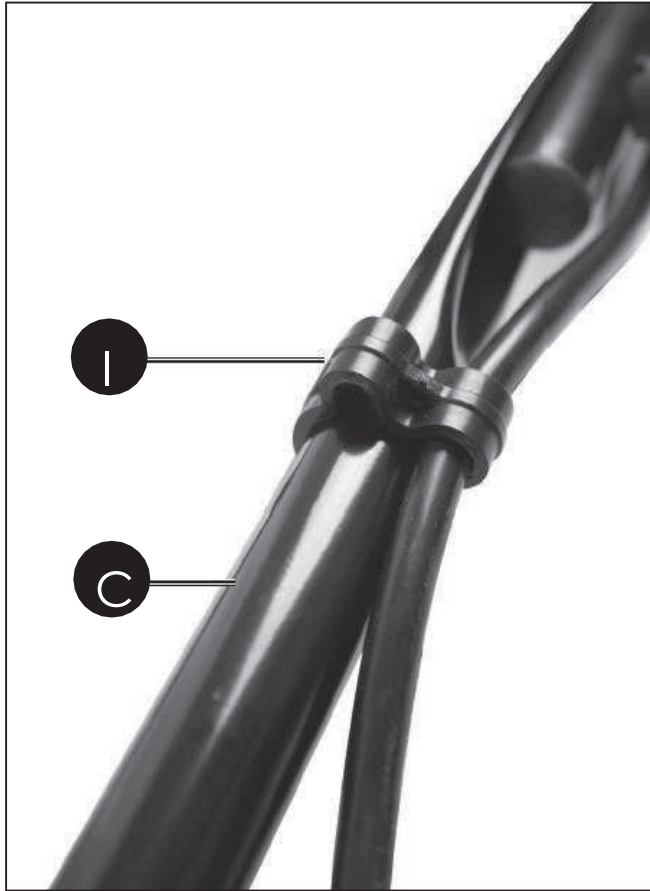

Operation

HYM3313E Starting

! **WARNING** - Before Operation you **MUST** read and fully understand the whole user manual

1. To Start the Machine hold the Safety **On/Off Safety Button (2)** down.
2. At the same time, pull the **OPC Lever (1)**. The machine should start.
3. When the machine has started, you can release the Safety Start Button.

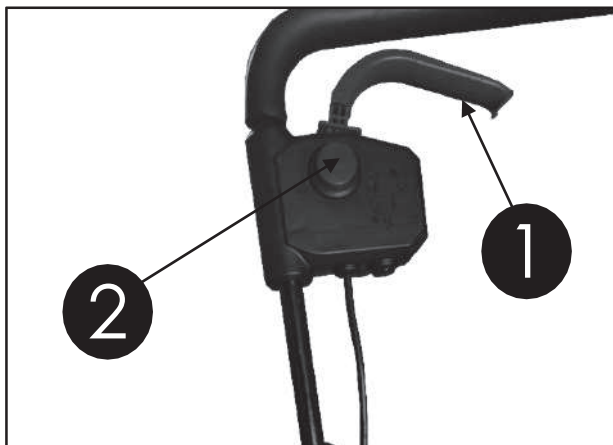

HYM3313E Stopping

To Stop the machine release the Start/Stop Trigger. The machine should stop.

! **WARNING** – After stopping the machine, for a few seconds the blade beneath the machine will keep rotating. Allowing time for this to stop before any other Operation or Maintenance

HYM3313E Mower Deck Grass Fins

The HYM3313E's deck features grass fins, which help to channel grass on the edges of lawns, close to fences & walls into the mower blade. The deck is wider than the wheel base; this paired with the grass fins helps ensure a clean cut on the edge of your lawns minimising stray blades of grass.



HYM3313E Cutting Height Adjustment

! WARNING – When adjusting the cutting height, ALWAYS ensure the machine is off and the cutting blade is not spinning

1. To adjust the cutting height, turn the machine on it's side.
2. The Axle is spring loaded into position. You must pull the Axle out of it's location, and move up or down to select a different position/cutting height.
3. The method of height adjustment is the same on both front and back wheels. For an optimal cutting result, match the height setting on both axles.

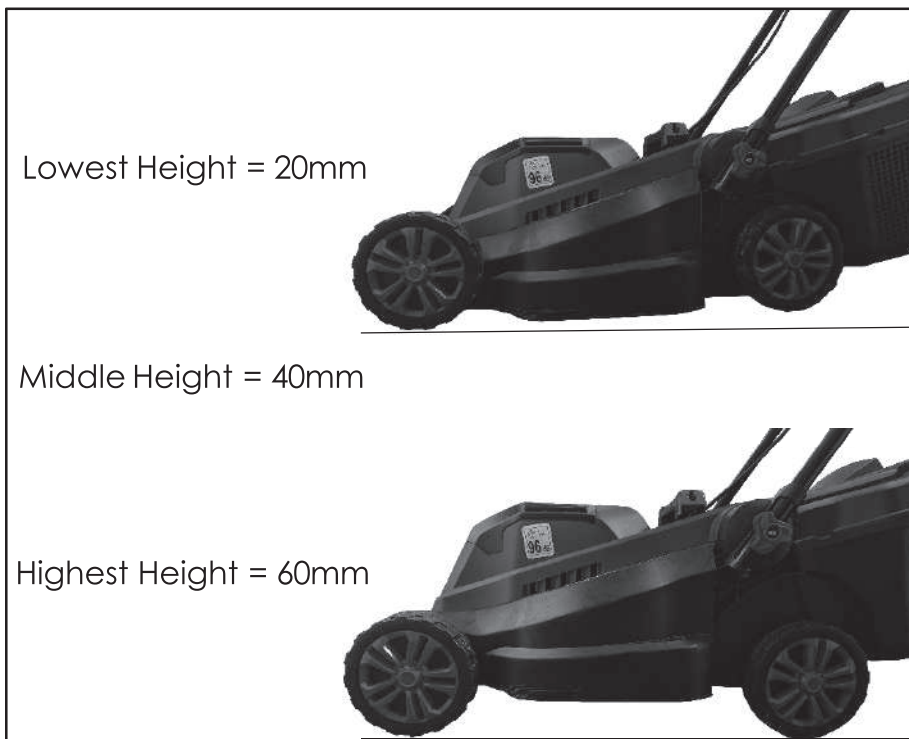
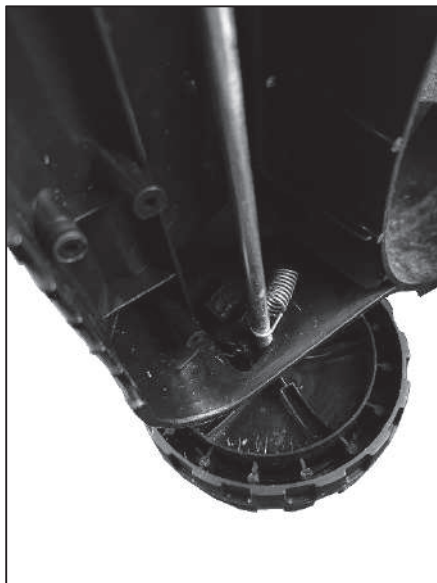
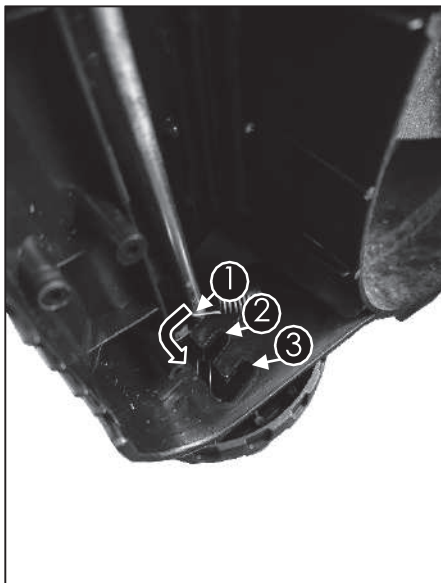

HYM3313E Grass Indicator

The Grass Collection Box has a **Grass level indicator Flap (K)**. This allows the user to know at a glance if the Collection Box needs emptying.

If the grass level indicator flap is open allowing air through it (as shown below) it isn't yet full.

If it is closed, this indicated the Grass Collection Box needs to be emptied

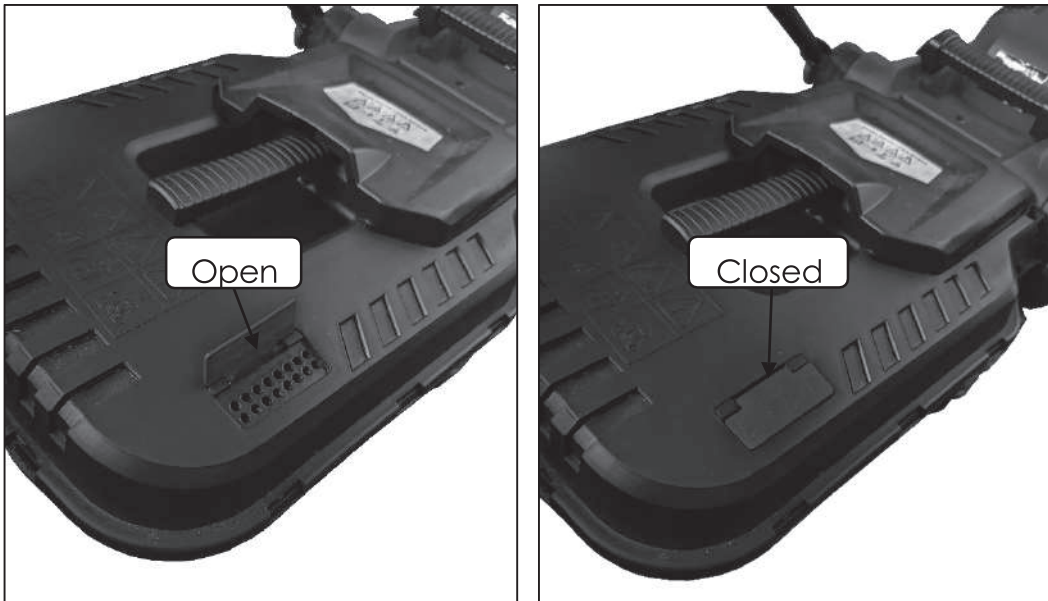

HYM3313E Grass Collection Box Emptying

Empty the grass collector frequently during use. Do not wait until it is completely full. We recommend emptying it when it is half full.

1. Switch the motor off.
2. Wait until the blade stops.
3. Lift the Rear Discharge Flap.
4. Remove the Grass Collection Box.
5. Lower the Rear Outlet Guard down again.
6. Empty the grass collector.
7. Before re-fitting, remove any obstructions from the rear discharge chute.

General Tips

- Maintain a constant cutting height. Do not shorten the grass to less than half its original height.
- Under certain conditions, such as very tall grass, it may be necessary to raise the height of cut to reduce pushing effort, prevent overloading of the motor and leaving clumps of grass clippings.
- It may also be necessary to reduce ground speed and/or push the lawnmower over the area a second time. For extremely heavy cutting, reduce the width of cut by overlapping the previously cut path and mow slowly.

How Often Should I Mow?

Spring (March, April & May)

Mow once a week on a high to medium height setting.

Summer (June, July & August)

Mow twice a week under good growing conditions on a low setting. In dry conditions, mow once a week on a medium to high height setting.

Autumn (September, October & November)

Mow once a week on a medium height setting.

Winter (December, January & February)

Mow as required on a high height setting.

Technical Data

Exploded Diagram

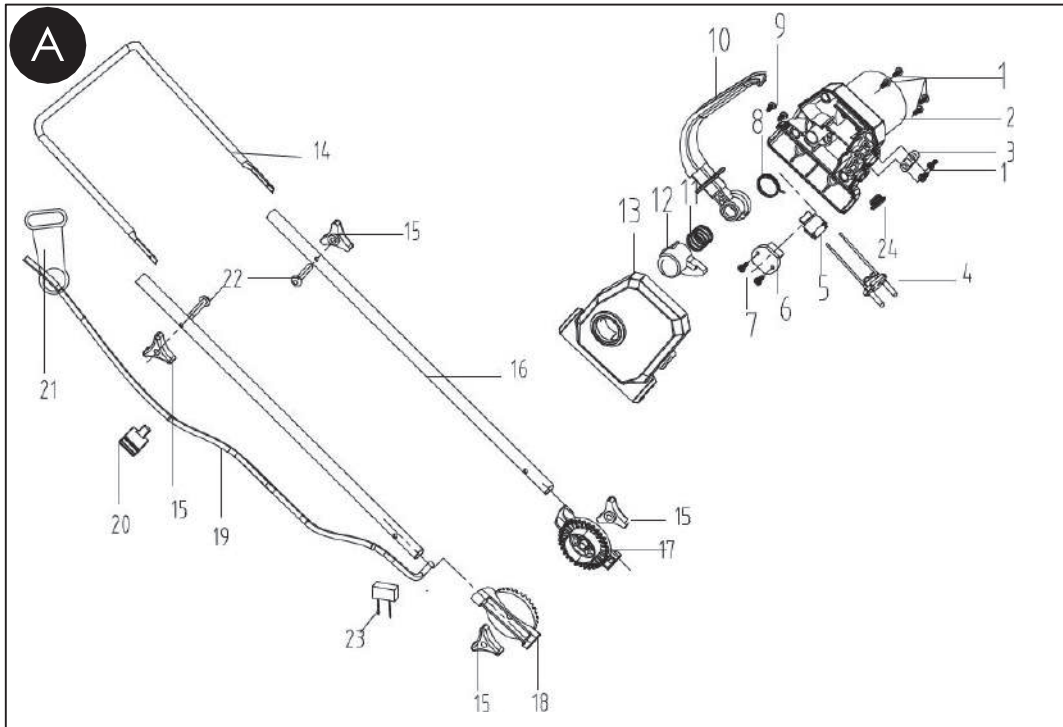

Image Reference	Description	Quantity
A1	Tapping screw	10
A2	Switch box lower cover	1
A3	Cord clamping plate	1
A4	Connector	1
A5	Rocker switch	1
A6	Waterproof plug	1
A7	Tapping screw	2
A8	Trigger spring	1
A9	Tapping screw	2
A10	Trigger	1
A11	Button spring	1
A12	Safety button	1
A13	Switch box upper cover	1
A14	Upper handrail	1
A15	Knob	4
A16	Lower handrail	2
A17	Left handrail seat	1
A18	Right handrail seat	1
A19	Cord	1
A20	Cord clip	1
A21	Cord hook	1
A22	Bolt	2
A23	Capacitor	1
A24	Rubber plug	1

Technical Data

Exploded Diagram

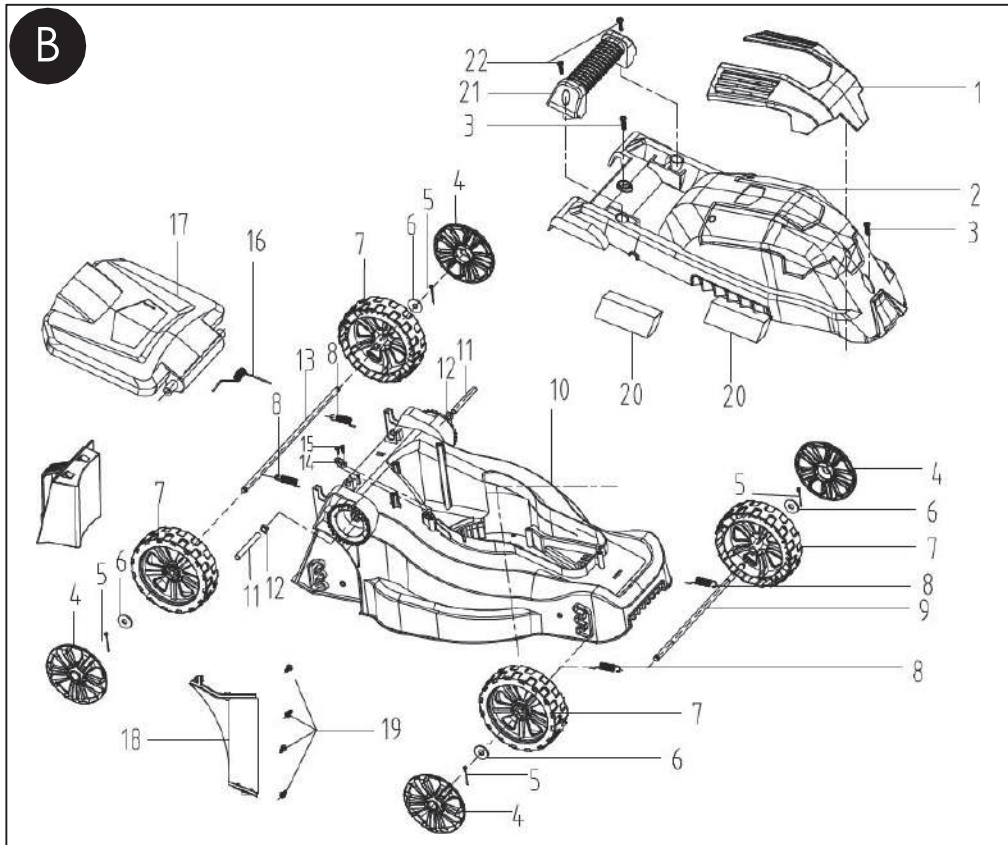

Image Reference	Description	Quantity
B1	Motor cover decorative sheet	1
B2	Motor cover	1
B3	Tapping screw	3
B4	Wheel cover	4
B5	Elastic cotter pin	4
B6	Flat washer	4
B7	Wheel	4
B8	Axle spring	4
B9	Front axle	1
B10	Chassis	1
B11	Double-end bolt	1
B12	Nut	2
B13	Rear axle	2
B14	Cord clamping plate	1
B15	Tapping screw	1
B16	Torsional spring	2
B17	Grass box cover	1
B18	Chassis baffle	1
B19	Tapping screw	1
B20	Dust sponge	4
B21	Carry handle	3
B22	Tapping screw	1

Technical Data

Exploded Diagram

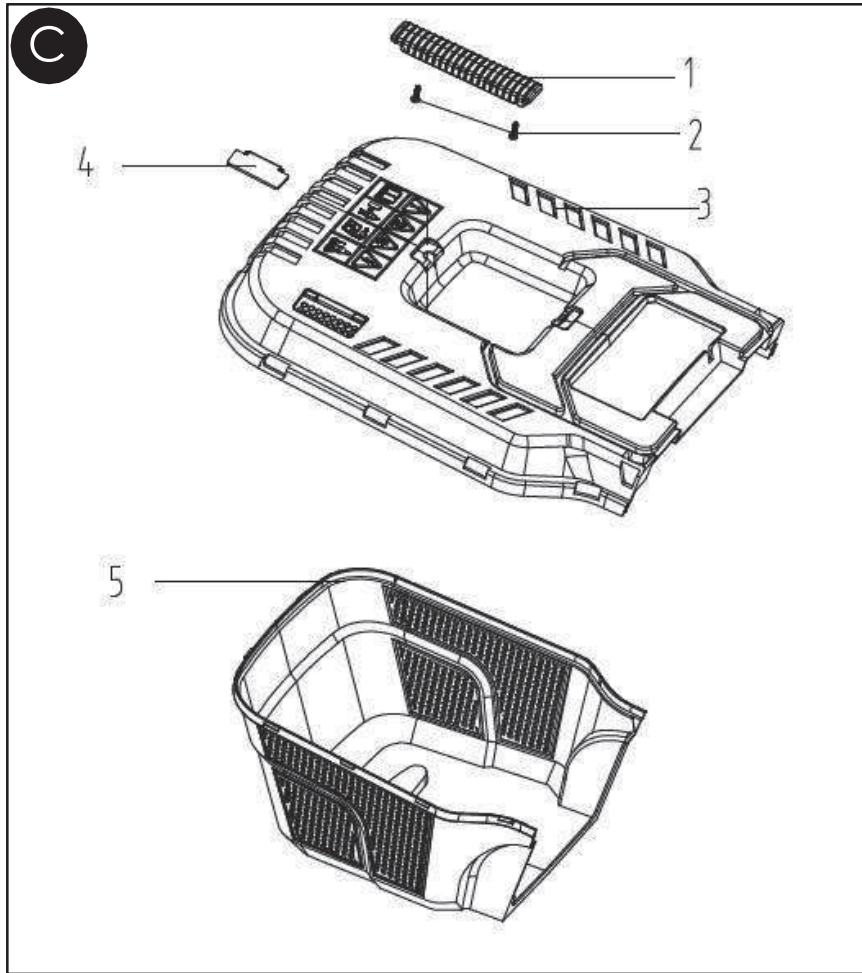

Image Reference	Description	Quantity
C1	Carry handle	1
C2	Tapping screw	2
C3	Upper cover	1
C4	Air handling panel	1
C5	Lower cover	1

Technical Data

Exploded Diagram

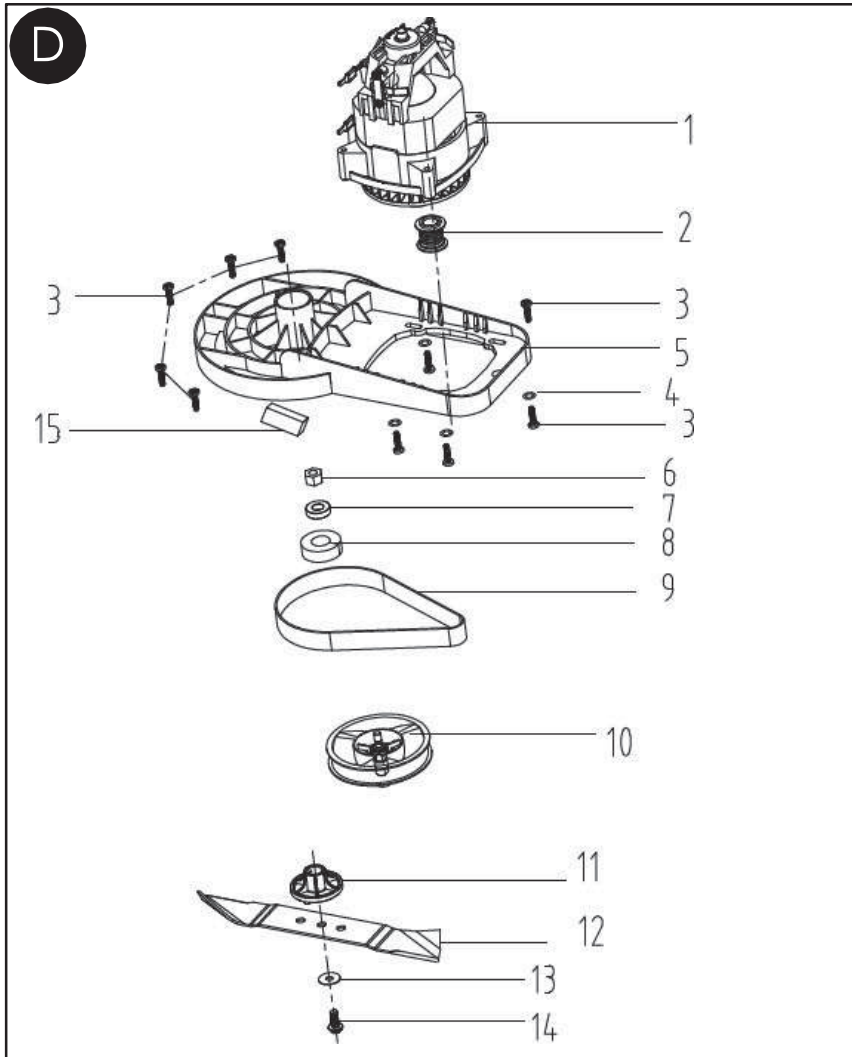
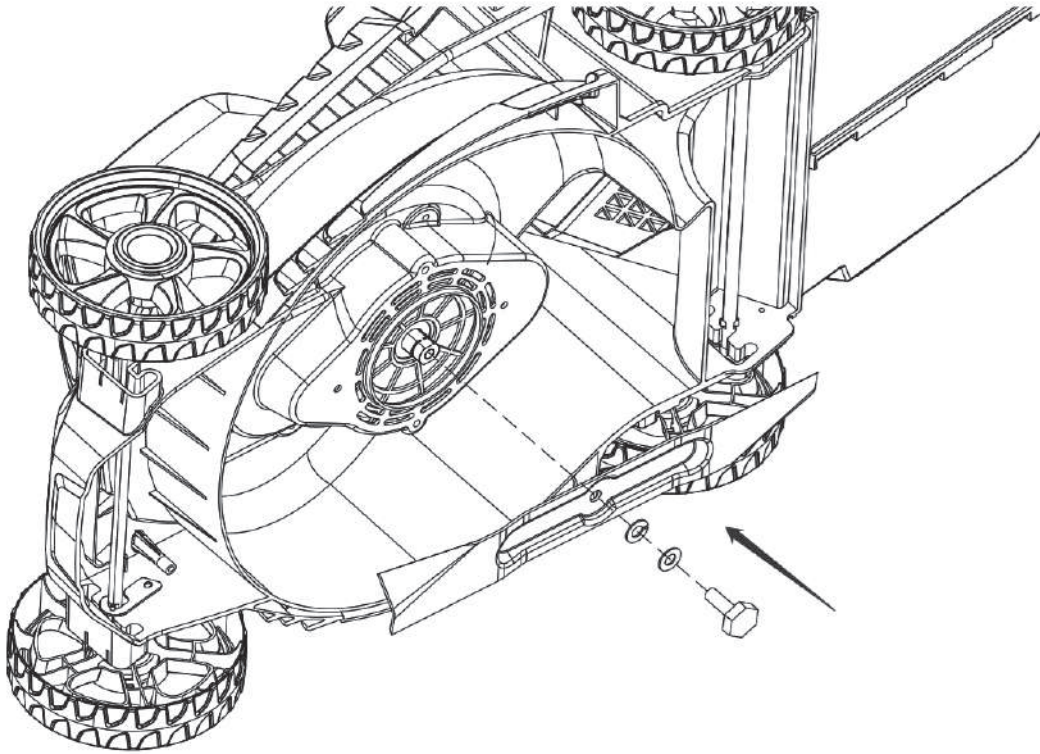

Image Reference	Description	Quantity
D1	Motor	1
D2	Small belt pulley	1
D3	Tapping screw	10
D4	Flat washer	4
D5	Motor bracket	1
D6	Nylon nut	1
D7	Bearing 609Z	1
D8	Bearing 6002Z	1
D9	Ribbed belt	1
D10	Belt sheave	1
D11	Balde holder	1
D12	Balde	1
D13	Flat washer	1
D14	Flange bolt	1
D15	Dust sponge	1

Maintenance & Care

Blade Maintenance

! WARNING - To prevent injury from the blade, have a specialist perform all work such as replacing or sharpening the blade (special tools and skills required).



Only use original spare parts: The use of non-original and/or incorrectly fitted parts will jeopardise the safety of the machine, may cause accidents or personal injuries for which the Manufacturer is under no circumstance liable or responsible.

Cleaning

! WARNING – Only Damp Clothes/Sponges should be used to clean. Using Running Water or Liquid Detergents can cause damage and unsafe operation.

1. Clean the equipment immediately after use with a damp cloth and some soft, non-abrasive soap. Do not use cleaning agents or harsh solvents; these may damage the plastic parts in the equipment. Ensure that no water penetrates the equipment's interior.
2. Remove grass and mud from inside the deck to prevent it from drying. This could cause problems the next time the lawnmower is used.
3. Keep all safety devices, air vents and the motor housing free of dirt and dust as much as possible.
4. Dry the machine completely. Keep the handles dry, clean and free of oil and grease.
5. Avoid using solvents when cleaning plastic parts. Most plastics are susceptible to damage

Maintenance & Care

Troubleshooting

Fault	Possible Remedy
Motor won't start	<ul style="list-style-type: none">• Check the fuse in the plug.• Check the cable for damage.• Make sure you are holding in the Stop/Start Safety button while pulling the OPC lever.• If the motor is hot, leave to cool down and try again.• Check underneath for excessive build-up of grass clippings which may be jamming the blade.
Mower not collecting grass	<ul style="list-style-type: none">• Make sure deck around the blade is clean and no debris is present• Ensure the rear chute between the deck and grass collection box has no grass build up or debris
Mower does not cut grass cleanly	<ul style="list-style-type: none">• Replace or re-sharpen the blade; contact an authorized service center• Correct the cutting height

Technical Data

Machine Specification

Model	HYM3313E
Voltage (V)	230-240
Frequency (Hz)	50-60
Rated Power (W)	1300
Cutting Width (cm)	33
No-Load Speed (rpm)	3600
Blade Type	Steel
Cutting Heights (mm)	20, 40, 60
Grass Collection Box Capacity (L)	30
Wheel Size (Inches)	5.5
Box Dimensions LxWxH	660*420*320
Net Weight (Kg)	7.5
Gross Weight (Kg)	10.3
Vibrations (m/s ²)	2.79 (k=1.5)
Sound Pressure Level LpA (dBA)	79.3
Pressure Level Uncertainty KpA (dBA)	3
Sound Power Level LwA (dBA)	90.3
Power Level Uncertainty KwA (dBA)	3

EU Declaration Of Conformity

Importer and Authorised Representative

Genpower Ltd
Isaac Way, Pembroke Dock, SA72 4RW

Country of Origin: China

Description: Electric Lawn Mower

SKU Code: HYM3313E

Date of Issue: 01/12/2023

Regulations and Directives of Compliance

- 2006/42/EC The Machinery Directive
- 2014/30/EU Annex II Electromagnetic Compatibility Directive
- 2011/65/EU RoHS
- 2000/14/EC Noise Emissions in the Environment by Equipment for use Outdoors

Conforming to the Following Requirements and Documents

- EN 60335-2-77:2010
- EN 60335-1:2012+A11:2014+A13:2017+A1:2019+A2:2019+A14:2019
- Declaration for 2000/14/EC Noise Emissions in the Environment by Equipment for use Outdoors.

Statement of Declaration

We the importer and authorised representative of the product described confirm conformity within the provisions of applicable regulations and directives listed within this document.

Signed on Behalf of Genpower Ltd

Place of Issue: Genpower Ltd

Signatory Name: Roland Llewellyn

Position: Managing Director

R J Llewellyn



Grass Trimmer – Instruction Manual

Instruction Manual Overview

This product is comprised of two separate items, and, as such, this manual contains instructions and diagrams which are only relevant to each respective item.

Only follow the instructions and guidance relevant to the item you are working on.

Electric Grass Trimmer HYM3313EGT

Instruction Manual

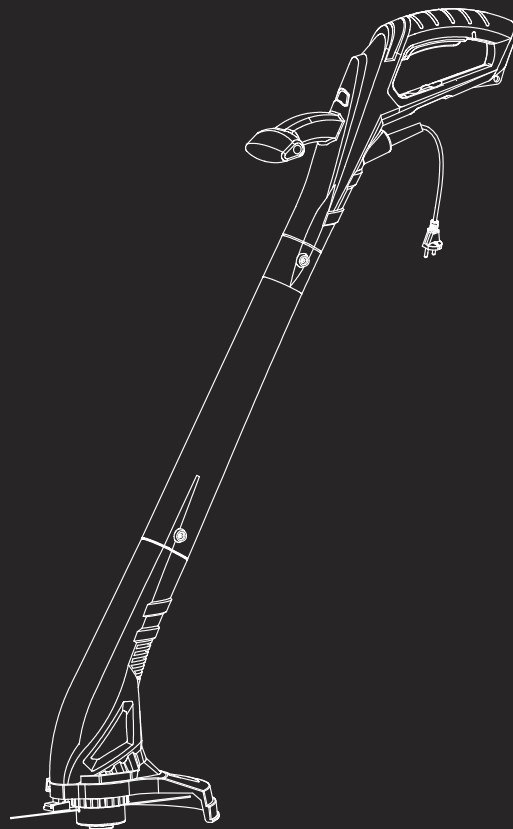

Safety Information

Understand Your Machine

- **WARNING!** You must read these instructions carefully before operating the machine. Make sure that you are familiar with the controls and properly operate the machine. You must learn how to stop the machine quickly. If you do not follow the warnings and instructions, it may result in fire and/or serious injury. Make sure to save all warnings and instructions for future reference.
- Read this manual and labels affixed to the machine to understand its limitations and potential hazards.
- Be thoroughly familiar with the controls and their proper operation. Know how to stop the machine and disengage the controls quickly.
- If the unit is to be used by someone other than original purchaser, or is to be loaned, rented, or sold, always provide this manual and any needed safety training before operation. You are responsible for making sure that accidents, personal injury and the risk to other people and property is avoided by reading and understanding this manual.
- Do not force the machine beyond its limits. Use the correct machine for your application.
- Know how to stop the machine quickly in case of emergency. Understand the use of all controls.
- ALL MAINTENANCE other than that listed in this manual, should be carried out by professionally trained and certified personnel.
- When using this machine for the first time and before actual work, you **MUST** learn how to handle the machine from an experienced or skilled person.

Personal Safety

- **WARNING!** Never allow children or people unfamiliar with these instructions to use the product. Local regulations can restrict the minimum age of the operator.
- Keep children, pets, and other people not using the unit away from the work area (at least 15m). Be alert and shut off the unit if anyone enters work area. Keep children under the watchful care of a responsible adult.
- Stay alert, watch what you are doing and use common sense when operating the machine. Never operate the machine when unwell or tired, or if you have taken alcohol, medicine, drugs or any substances which may slow your reflexes and compromise judgment. A moment of inattention while operating the machine may result in serious personal injury.
- Appropriate Personal Protective Equipment (PPE), **MUST** be worn at all times when operating or repairing the machine. Always wear anti-slip and resistant work footwear and long trousers while using the machine. Do not use the machine when barefoot, wearing sandals or similar lightweight footwear. Do not wear chains, bracelets or clothing that is loose fitting or hanging ties or cords. Tie long hair back. Always wear protective earplugs. Loose clothes, jewellery, or long hair can be caught in moving parts. Protect eyes, face, and head from objects that may be thrown from the unit. Always wear safety goggles or safety glasses with side shields when operating.
- Always keep hands and feet away from all moving parts during operation. Moving parts can cut or crush body parts. Always keep hands and feet away from all pinch points.

Safety Information

Personal Safety (Continued)

- Do not touch parts that might be hot from operation. Allow parts to cool before attempting to maintain, adjust, or service.
- Do not overreach. Keep proper footing and balance at all times. This enables better control of the machine in unexpected situations. Extending your body too far can result in a loss of balance and you may fall which will result in injury.
- Never place any part of your body where it would be in danger if movement should occur during assembly, installation, and operation, maintenance, repairing or moving.
- Keep in mind that the operator or user is responsible for accidents, hazards or unexpected events involving the machine that occur to other people or their property. It is the responsibility of the user to assess the potential risk of the area where work is being carried out. The operator or user must take all necessary precautions to ensure their own safety and that of others, especially on slopes or rough, slippery and unstable ground.

Inspect Your Machine

- Check your machine before starting it. Keep guards in place and in working order. Make sure all nuts, bolts, etc., are securely tightened.
- You must check the general condition of the machine before use.
- Never operate the machine when it is in need of repair or is in poor mechanical condition. Replace damaged, missing, or failed parts before using it. Keep the machine in safe working condition.
- Do not use the machine if the machine's switch does not turn off the machine when running. Any machine that can't be controlled with the switch is dangerous and must be replaced.
- Regularly check to see that keys and adjusting wrenches are removed from the machine area before starting it. A wrench or a key that is left attached to a rotating part of the machine may result in personal injury.
- If the machine should start to vibrate abnormally, stop the machine and check immediately for the cause. Vibration is generally a warning sign of trouble.
- Avoid accidental starting. Be sure the switch is off before transporting the machine or performing any maintenance or service on the unit. Transporting or performing maintenance or service on a machine with its switch on invites accidents.
- Do not tamper with or disable safety systems.
- Only use manufacturer-recommended attachments.
- Before using, always visually inspect to see that the tools are not worn out or damaged. Replace worn out or damaged elements and bolts in set to preserve balance.
- Keep the machine in good operating condition. Operating the machine in poor or questionable condition could result in serious injury.
- Be sure all safety devices are in working order and warning labels are in place. These items are installed for your safety.

Safety Information

Work Area

- You must only work in daylight or with good artificial light in good visibility conditions. Do not work at night, at times of heavy fog, or at any other times when your field of vision might be limited and it would be difficult to gain a clear view of the area.
- Keep people, children and animals away from the working area.
- Operate on flat, level ground.
- DO NOT work on wet ground. If there has been heavy rain on the working site, wait until the ground has dried up.
- Never use the machine on unstable ground which could give way and always rest the machine in a safe, solid area when not in use.
- You must be careful near ravines, ditches or embankments.
- Exercise extreme caution when operating on or crossing gravel drives, walks, or roads. Stay alert for hidden hazards or traffic.
- Do not work in the rain, when there is a thunderstorm or lightning risk, at times of strong or gale force winds, or at any other times when the weather conditions might make it unsafe to use this product. If there is bad weather conditions, do not use the machine.
- Make sure you thoroughly inspect the entire work area and remove all objects and anything that could be thrown by the machine or could damage the machine (branches, stones, wire, toys, etc). Attempting to clear the work area whilst using the machine will reduce your concentration and creates a trip hazard. Any liquid spilled on the floor may result in you slipping.
- Find and locate all fixed objects in the ground, such as sprinkler systems, poles, water valves, bases for washing lines etc. Make sure that you check for hidden electrical cables or similar on the surface of the lawn. ALWAYS run the machine around these objects. NEVER run the machine over foreign objects.
- DO NOT operate power tools in explosive atmospheres, such as in the presence of flammable liquids, gases or dust. Power tools may create sparks, which may ignite the dust or fumes.
- This machine is only for outdoor use.

Safety Information

During Use

- Do not operate the machine in confined areas where there may be a risk of crushing the operator between the machine and another object.
- Never attempt to make any adjustments, while the machine is running.
- You must switch off the machine:
 - Before checking or working on the machine.
 - When transporting the machine.
 - Whenever you leave the machine unattended.
 - If the machine starts to vibrate abnormally.
- **WARNING!** If something breaks or an accident happens whilst working, you must turn off the machine immediately and move the machine away to prevent further damage. If an accident happens with injuries or third parties are injured, carry out the first aid measures most suitable for the situation immediately and contact the medical authorities for any necessary health care. Carefully remove any debris that might cause damage or harm persons or animals should it not be seen.
- After striking a foreign object, stop the machine immediately and inspect the machine thoroughly for damage. Repair the damage before continuing.
- Keep extension cord away from cutting elements.
- Never operate the machine with damaged guards or without the guard in place.
- Keep hands and feet away from the cutting means at all times especially when switching on the motor.
- Take care against injury from the blade fitted for trimming the filament line length. After extending new cutter line, always return the trimmer to its normal operating position before switching on.
- Never operate the machine without the defective guards or shields, or without safety devices, or if the cord is damaged or worn.

Safety Information

Electricity (Where Applicable)

DANGER : ELECTRICITY CAN KILL – NEVER WORK ON LIVE / ENERGISED EQUIPMENT.



- Prior to carrying out any maintenance work you **MUST** identify electrical isolation methods and isolate all electrical supplies.

Prior to use and with all electrical supplies isolated, you **MUST** check all electrical cables, plugs and connectors for the following;

- Are intact and have no signs of damage, to include but not limited to bare wires, chaffing, cuts and loose wiring.
- If there are any signs of damage, the damaged item **MUST** be taken out of service until the damage has been repaired by an electrically competent person.
- All trailing cables should be routed so as not to cause any kind of trip hazard.
- **NEVER** work on or near electricity with wet hands, wet clothing and wet gloves.
- Power tools plug must match the outlet. Never modify the plug in any way. **DO NOT** use any adapter plugs with earthed (grounded) power tools. Unmodified plugs and matching outlets will reduce risk of electric shock.
- **DO NOT** expose this power tool to rain or wet conditions. Water entering a power tool will increase the risk of electric shock. **DO NOT** abuse the power cord. Never use the cord for carrying, pulling or unplugging the power tool. Keep the cord away from heat, oil and sharp edges or moving parts. Damaged or entangled cords increase the risk of electric shock. When operating a power tool, use an extension cord suitable for outdoor use. Use of a cord suitable for outdoor use reduces the risk of electric shock.
- **IMPORTANT:** Make sure that the electric circuit is fused, and that the power, voltage and frequency of the motor is supported by your mains supply. Also, make sure that your power supply is earthed. Connect your machine to earth. Never open the ON/OFF switchbox. However, if it should become necessary to do so, contact a qualified electrician. Make sure that you will never touch live contacts, specifically when you plug or unplug your machine. This machine and its power cord must never get into contact with water.
- Avoid body contact with earthed or grounded surfaces such as pipes, radiators, ranges and refrigerators. There is an increased risk of electric shock if your body is earthed or grounded.
- To prevent electric shock, use only with an extension cord suitable for outdoor use. For additional protection, the installation of a residual current device (RCD) having a rated residual operating current not exceeding 30mA is advisable.
- Before use, check that the extension cord is in good condition. When using an extension cord, make sure to use one heavy enough to carry the current your product will draw. An undersized cord will cause a drop in line voltage resulting in loss of power and overheating.
- Do not allow any part of the machine to make contact with water while it is in operation. If the appliance becomes wet while turned off, wipe dry before starting. Do not touch the appliance or its plug with wet hands or while standing in water. Wearing rubber boots offers some protection.
- Before use, check the supply and extension cord for signs of damage or aging. If the cord becomes damaged during use, disconnect the cord from the supply immediately. If the supply cord is damaged, it must be replaced by the manufacturer or a qualified person in order to avoid a hazard.

Safety Information

Double-Insulated Appliances

In a double-insulated appliance, two systems of insulation are provided instead of grounding. No grounding means that it is already provided on a double-insulated appliance. Servicing a double-insulated appliance requires extreme care and knowledge of the system, and should be performed only by qualified service personnel. Replacement parts for a double-insulated appliance must be identical to the parts they replace.

Safety Information

Vibrations (Where Applicable)

- Prolonged use of hand held (operated) machines will cause the user to feel the effects of/from vibrations. These vibrations can lead to white finger (Raynaud's phenomenon) or carpal tunnel syndrome. This condition reduces the ability of the hand to feel and regulate temperature, causing numbness and heat sensations and may cause nerve damage and circulatory tissue death.
- Not all factors that lead to white finger disease are known, but cold weather, smoking and other diseases that affect blood vessels and blood circulation as well as large and long-lasting impact of shocks are considered factors in the formation of white finger. Note the following to reduce the risk of white finger and carpal tunnel syndrome;
 - Wear gloves and keep your hands warm.
 - Take regular breaks.
 - All of the above precautions may help reduce the risk of white finger disease but not rule out the carpal tunnel syndrome. Long-term and regular users are therefore recommended to observe the condition of your hands and fingers. Seek medical attention immediately if any of the above symptoms should occur.

Noise (Where Applicable)

- The operating noise of the machine can damage your hearing. When wearing protection such as ear plugs or ear defenders to protect your hearing. Long-term and regular users are advised to have hearing checked regularly. Be especially vigilant and cautious when wearing ear protection because your ability to hear alarm warnings will be reduced.
- Noise emissions for this equipment is unavoidable. Carry out noisy work at approved times and for certain periods. Limit the working time to a minimum. For your personal protection and protection of people working nearby it is also advisable for them to wear hearing protection.



- See Certificate of Conformity section for Outdoor Noise declaration of conformity.

Residual Risks

Even when tool is used as prescribed it is not possible to eliminate all residual risk factors. The following hazards may arise in connection with the tool's construction and design:

1. Damage to lungs if an effective dust mask is not worn.
2. Damage to hearing if effective hearing protection is not worn.

Health defects resulting from vibration emission if the power tool is being used over longer period of time or not adequately managed and properly maintained.

 WARNING! This machine produces an electromagnetic field during operation. This field may under some circumstances interfere with active or passive medical implants. To reduce the risk of serious or fatal injury, we recommend persons with medical implants to consult their physician and the medical implant manufacturer before operating this machine.

Intended Use

The HYM3313EGT is an electric grass trimmer from HYUNDAI. It has a cutting width of 220mm and is powered by a 250W HYUNDAI motor.

This machine is a garden tool and precisely a pedestrian controlled grass trimmer. The machine is manufactured according to the latest safety requirements. Every precaution is only effective when it is followed exactly.

Intended Use

This machine was designed and manufactured for trimming excess grass in gardens and grassy areas, in areas in proportion to its cutting capacity, controlled by a pedestrian operator.

User Types

This machine is intended for use by consumers, i.e. non professional operators. The machine is intended for "DIY" and domestic use only.

Improper Use

Any other usage not in keeping with the above mentioned ones may be hazardous and harm persons and/or damage things. Examples of improper use may include, but are not limited to:

- Using the machine to trim hedges.
- Cutting anything other than grass.
- Using the blade on surfaces other than grass.
- Never fit with metal cutting elements.

Safety Information

Personal Protective Equipment

Appropriate Personal Protective Equipment (PPE), MUST be worn at all times when operating or repairing the machine. No protective equipment can ensure 100% protection.

When selecting PPE, make sure it's CE marked and it suits the user in terms of size, fit, etc. If more than one item of PPE is worn at the same time, make sure they can be used together, e.g. wearing safety glasses may disturb the seal of a respirator, causing air leaks.



Hand Protection Must Be Worn

Protective electrically non-conductive gloves are highly recommended when working.



Foot Protection Must Be Worn

Non-skid heavy duty footwear are highly recommended when working.



Hearing Protection Must Be Worn

Suitable safety hearing protection is recommended.



Eye Protection Must Be Worn

Always wear safety glasses/goggles and/or face shields. Everyday eyeglasses have only impact resistant lenses; they are not safety glasses/goggles.



Protective Clothing Must Be Worn

Do not wear loose clothing, gloves, scarfs, neckties or jewellery (rings, wrist watches), which can be caught in moving parts.



Head Protection Must Be Worn

Wear a safety helmet with a safety visor.



Face Shield Must Be Worn

Wear a face shield to protect your face.













Respirator Must Be Worn

Wear a respirator.

Safety Information

⚠ Symbols On The Machine

We have provided safety messages in this manual and on the machine. This information alerts you to potential hazards that could hurt you or others. Please read these messages carefully. However, we may not have listed all of the possible hazards, you must also use your own judgement.

Symbol	Description	Symbol	Description
	Safety alert – Indicates a precaution, a warning or a danger.		Disconnect the mains plug if the cord becomes damaged or entangled.
	Do not expose to rain.		Class II tools symbol.
	Wear hearing protection.		Wear eye protection.
	Read operator's manual.		This product complies with the European directives and an evaluation method of conformity for these directives was done.
	The UKCA (UK Conformity Assessed) marking is a UK product marking that is required for goods being placed on the market in Great Britain (England, Wales and Scotland).		Keep bystanders at a safe distance away from the work area.
	Disposal.		

Features/In The Box (Grass Trimmer)

*Not To Scale

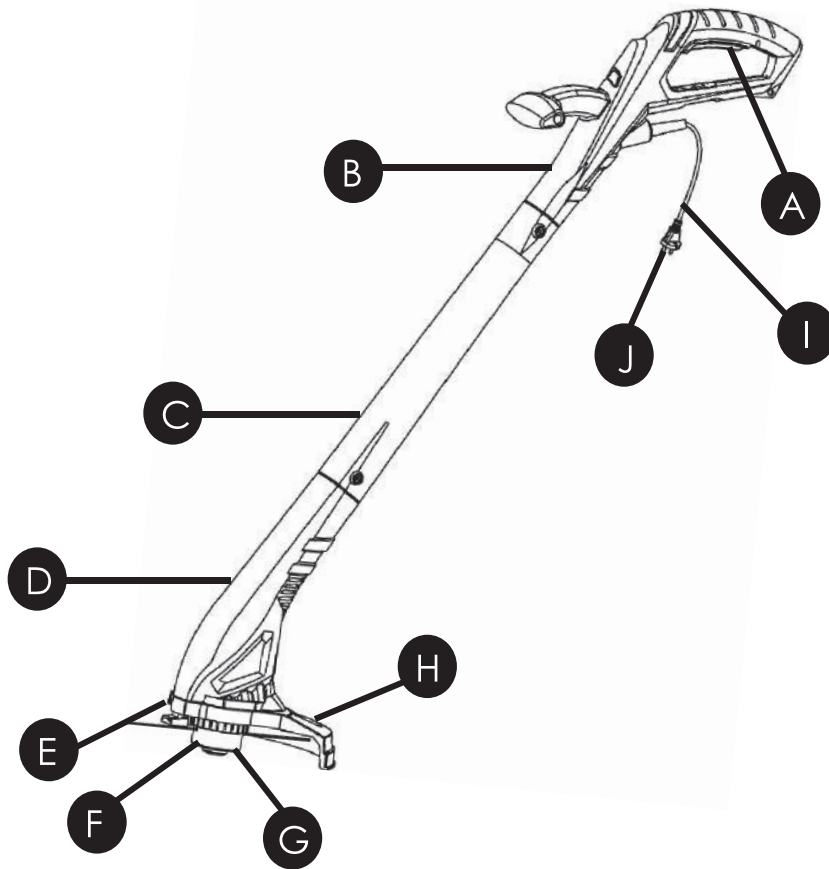

- A. **Trigger Switch** – Use this to start the trimmer, and to operate the throttle
- B. **Main Handle** – Hold onto this firmly when operating the trimmer
- C. **Trimmer Shaft**
- D. **Motor Housing** – This protects the motor
- E. **Bracket**
- F. **Spool**
- G. **Spool Cover**
- H. **Safety Guard**
- I. **Power Cord** – When the grass collection box is full, the indicator flap will be closed.
- J. **Cable Relief Hook**

Assembly (Grass Trimmer)

Grass Trimmer Assembly – Overview

There are four steps to the assembly for the grass trimmer:

STEP 1: Connect The Trimmer Shaft To Main Handle & Motor Housing

STEP 2: Attach The Safety Guard To The Motor Housing Head

STEP 3: Connecting Cable

STEP 4: Cable Holder On Handle

STEP 1: Connect The Trimmer Shaft To Main Handle & Motor Housing

NOTE: This step requires the use of the **4 x 18mm tapping screws** and a Phillips screwdriver (not included in the box contents of this product) to attach the trimmer shaft to main handle and motor housing.

1. Fix the trimmer shaft to the motor housing by sliding the trimmer shaft over the top of the motor housing's shaft. Ensure the two shaft's are perfectly aligned in order to fit the **tapping screws** to secure the assembly.
2. Insert 2 of the 4 **tapping screws** through the holes located above the motor housing.
3. Use a Phillips screwdriver to fasten the screws to the shaft.

1.



2.



Assembly (Grass Trimmer)

STEP 1: Connect The Trimmer Shaft To Main Handle & Motor Housing (Continued)

4. Attach the main handle to the trimmer shaft by sliding the main handle shaft's over the top of the trimmer shaft.
5. Ensure the trimmer shaft and main handle assemblies are perfectly aligned in order to fasten the 2 remaining tapping screws to the unit.
6. Use a Phillips screwdriver to fasten the tapping screws to the unit.

4.



5.



Picture (left) depicts the grass trimmer shaft's correctly attached to the main handle and the motor housing.

Assembly (Grass Trimmer)

STEP 2: Attach The Safety Guard To The Motor Housing Head

NOTE: The safety guard comes with a single screw to be fastened through the hole located on the guard, which feeds into a secondary hole when lined up with the motor head.

This steps requires the use of a Phillips screwdriver (not included in the box contents of this product) to tighten the screw when securing the safety guard to the motor head.

1. Take the safety guard and slot it across the top of the motor head in the orientation as pictured below.

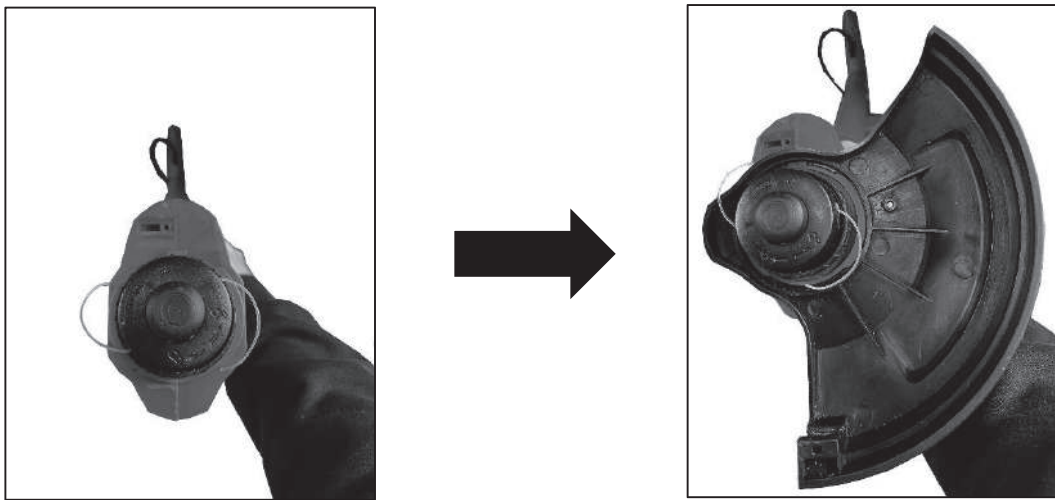

2. Rotate the safety guard 90 degrees anti-clockwise to line up the two holes located in the safety guard and motor head.

3. Once aligned, insert the screw and tighten with a Phillips screwdriver.

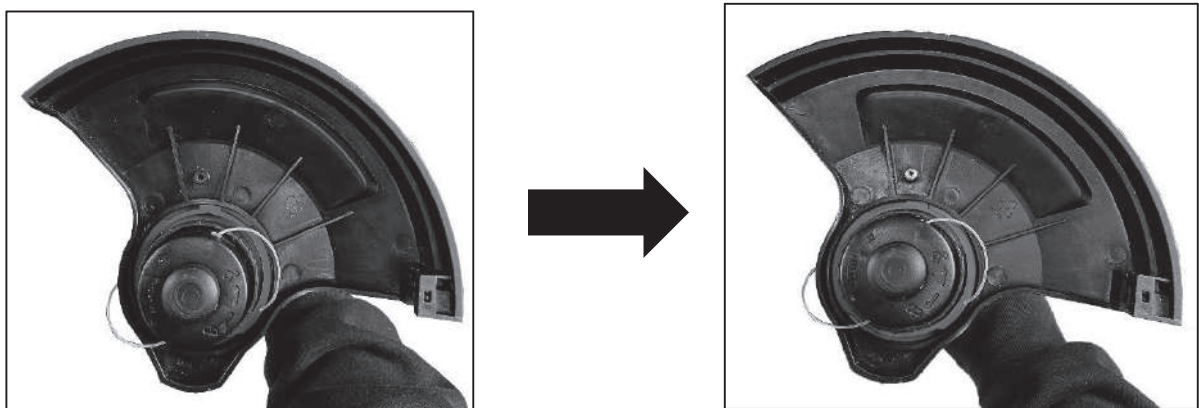

Assembly (Grass Trimmer)

STEP 3 : Connecting Cable

1. Line the plug up with the two holes and push into place.



Assembly

STEP 4 : Cable Holder On Handle

⚠ Make sure the machine is disconnected from power before you do this. If the machine is plugged in, you may accidentally press the trigger switch.

This holds the cable in place while in use and prevents strain on the cable.

1. Make a small loop in the power cable **(A)**.
2. Put the loop through the hole in the handle and on to the hook **(B)**.
3. Slowly pull the loop to remove slack.

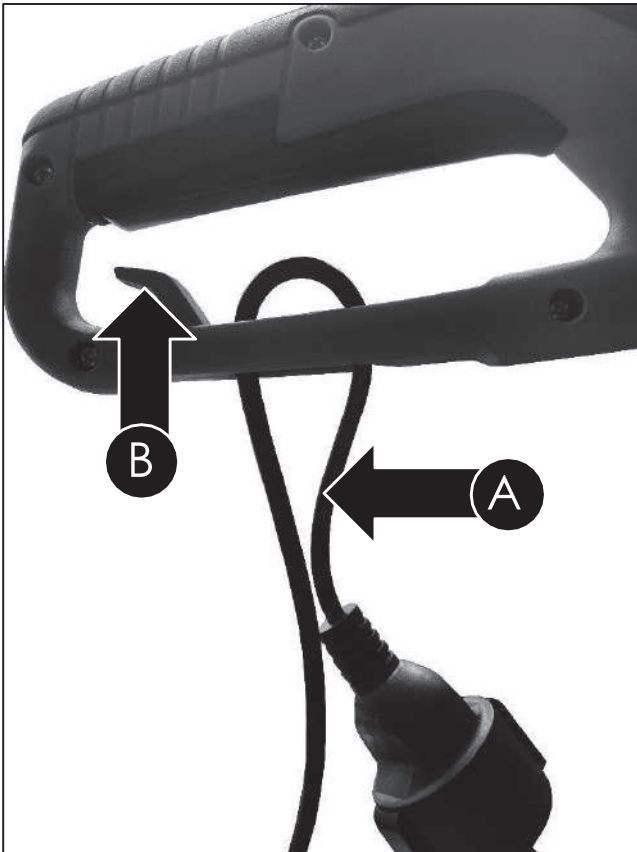

Tips For Use

After reading the safety instructions carefully, follow the instructions below attentively in order to get the most out of your grass trimmer.

1. Start off slowly, when you have gained experience, you will be able to use the grass trimmer to its full potential.
2. Start the grass trimmer before getting close to the grass being cut.
3. Cut the grass by moving the grass trimmer from right to left and proceed slowly.
4. High grass should be cut in layers, always beginning from the top. The cuts should be short.
5. You must always work with the cable away from the trimmer.

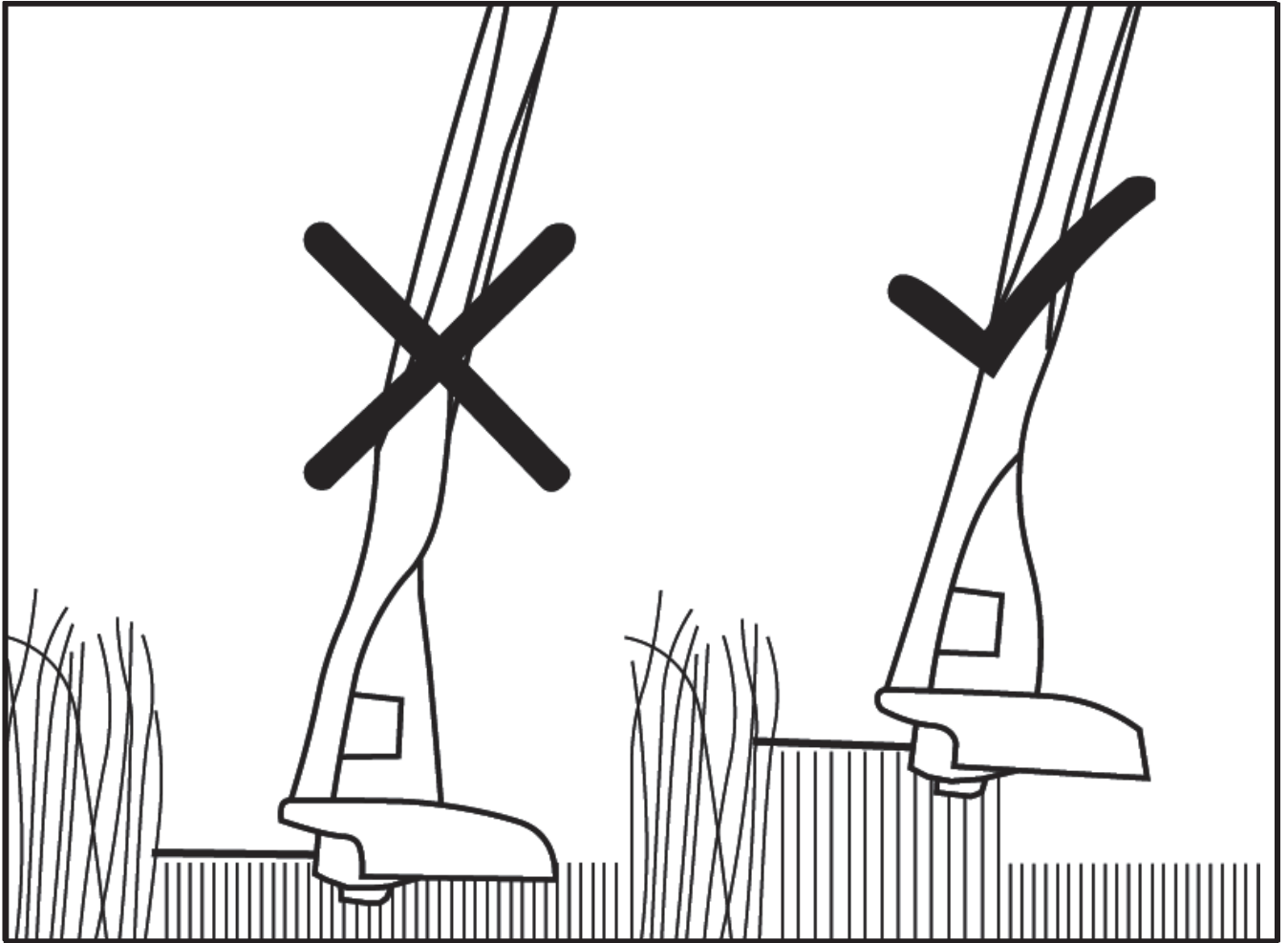

Before Starting

1. Check the condition of the cable, if damaged do not use.
2. Ensure that no objects or branches are trapped into the machine.
3. Ensure the work area is tidy and free of any obstacles.
4. Never operate the machine if it is damaged in any way.

Automatic Line Feed

Every time the machine is switched on, the trimmer line will automatically be given out. You do not need to extend it yourself. There is a built-in line cutter so it will cut the line to make sure it is not too long. You must make sure the cutting head has stopped completely before switching the machine on again.

When the trimmer line has run out, you can replace it following the instructions in this manual. You can either replace the trimmer line or replace the whole spool.

Operation

Starting

! YOU MUST read and understand the full safety instruction manual before starting the machine.

1. To start, press and hold the trigger switch **(A)**.

Stopping

! WARNING : Cutting elements continue to rotate for a moment after the motor is switched off.

! WARNING : Always switch off machine before placing it down.

1. Release the trigger switch **(A)**.
2. Unplug from the mains supply.



Maintenance & Care

General Maintenance

⚠ WARNING : Turn OFF the machine, allow all moving parts to come to a complete stop, and disconnect the power cord before maintaining the machine. You need to wear proper clothing and protective gloves whenever your hands are at risk.

- Keep all nuts, bolts and screws tight to be sure the machine is in a safe working condition.
- Replace worn or damaged parts for safety. Only use manufacturer-recommended parts and accessories.

Cleaning

⚠ Always remove the electric plug from the mains supply before any cleaning is undertaken.

- Remove any grass and mud after each use to prevent it from drying. Use a clean cloth to remove dirt, grease, etc.
- DO NOT use any water on any part of the main machine.
- Avoid using solvents when cleaning plastic parts. Most plastics are susceptible to damage from various types of commercial solvents and may be damaged by their use.
- Always ensure that ventilation openings are kept clear of debris.

Trimmer Line

There are two options to replace the trimmer line:

- 1. Replace Trimmer Line** (Keep the same spool and re-fill with new trimmer line).
- 2. Replace Spool** (Replace the empty spool with a new spool that is ready to use).

There are instructions on how to do both options in this manual.

Maintenance & Care

Replacing Trimmer Line

⚠ WARNING : Make sure the machine is disconnected from the power supply.

NOTE: Use the pictures provided in this section in accordance with the written steps.

1. Begin by carefully turning the trimmer so the cutting head is facing upwards.
2. Remove the spool cover from the bump head by pressing down on the cover and rotating it anti-clockwise until it becomes free.
3. Once the spool cover is detached, remove the spring.

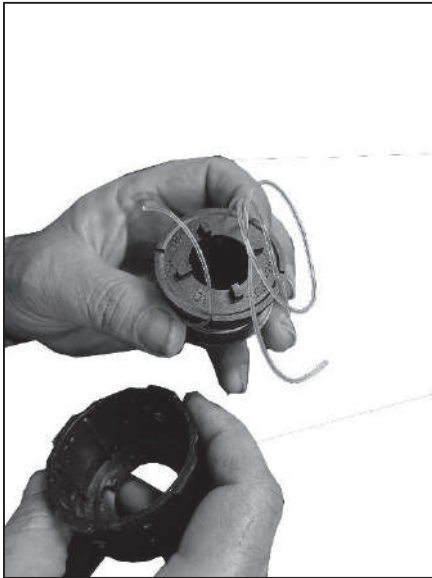

NOTE: Before feeding the line to the spool, measure the length of the line to start at the centre. This ensures both ends of the line will be equal when feeding it onto the spool.

4. Take the bump module in your left hand and feed the centre of the line/wire over the central cut out/notch.
5. Feed the remainder of the line onto the spool by rotating the bump module. Ensure the top of the spool is rotating away from you.

IMPORTANT: Ensure one end of the wire is in each of the two grooves.

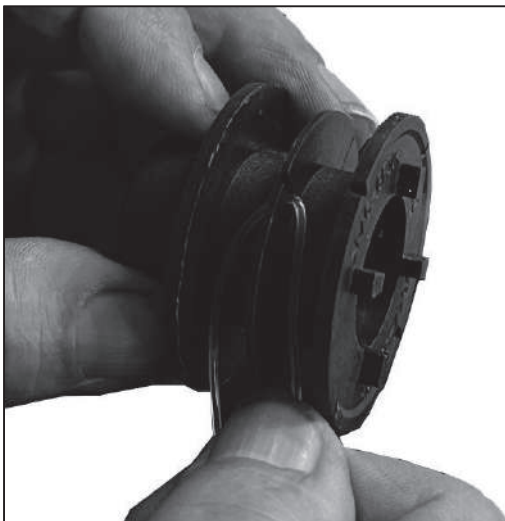

Maintenance & Care

Replacing Trimmer Line (Continued)

6. Wind the spool until you are left with 100ml of cutting line/wire available at each end of the cable.
7. Retain both ends of the line through the notches located on the bump module as pictured below.

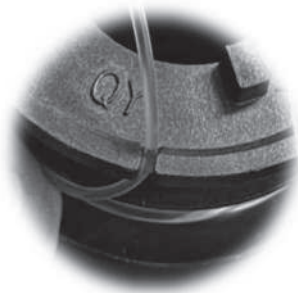
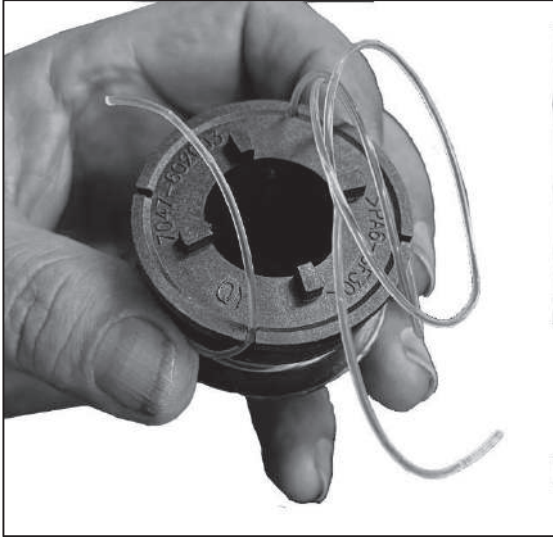

Clip the line/wire into both retaining notches as pictured.

8. Take the spool cover and feed both ends of the line/wire through its holes. Refit spool cover in the same orientation as it was removed once complete.
9. Once both ends of the line/wire have been fed through the spool cover's holes, refit the spring back into spool's central hole.

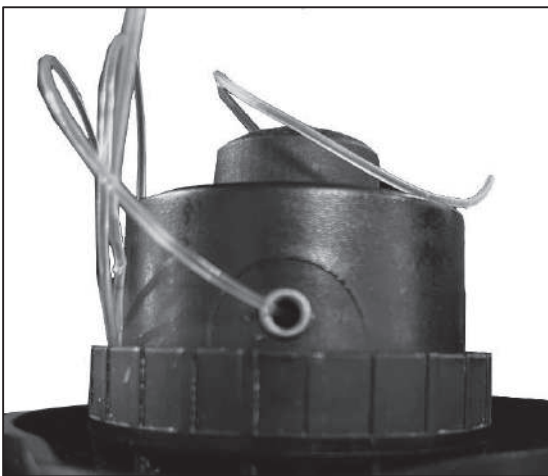

Replacing Trimmer Line (Continued)

10. Place the complete bump head assembly onto the trimmer's cutting head with the button facing upwards towards you.

NOTE: When placing the bump head back onto the cutting head, hold the main unit with one hand to stop it from rotating.

11. Push down on the bump head and rotate it clockwise to lock into place. You will hear an audible click as it connects to the cutting head.

NOTE: The bump head must connect with the grooves located in the cutting head. Locking the bump head may require you to rotate the bump head until it is correctly aligned the locking grooves.

NOTE: If fitted correctly, the spool cover's hole will sit marginally above the top of the cutting head's outer ridge (A).

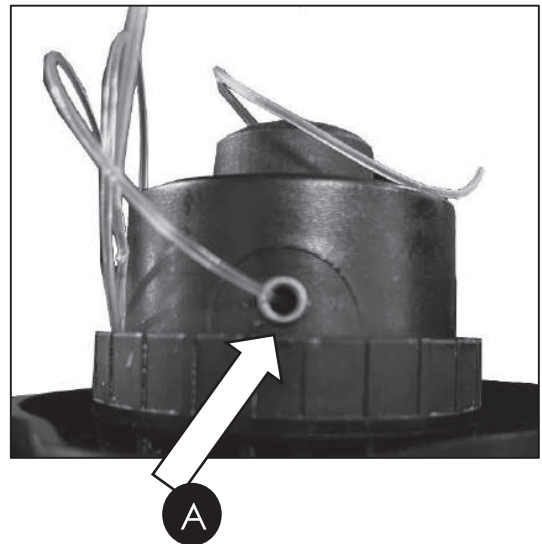

12. Once the bump head has been successfully reattached to the cutting head, pull the line/wire through spool cover's holes to release it from the two retaining notches.

NOTE: We advise that you trim away any excess line within the width of the cutting blade (B) located within the guard.

Maintenance & Care

Storage

⚠ Keep the machine stored in a dry, level area away from damp, moisture and rain fall. Allow the machine to cool down before storing.

- Make sure the machine is clean and dry before storing. You can keep the cable tidy by wrapping it around the hook on the rear of the machine. You can also store the gun and accessories in the slots at the rear of the machine.
- Ensure the machine is stored in a position, where any persons cannot step on, to attempt to reach items up high, due to risk of movement.
- DO NOT store the machine near an ignition source, such as a wood stove, gas or electric heater, or an appliance or heater with a pilot light.
- Store the machine out of reach of children or anyone who is not familiar with operation.
- DO NOT stack other items on top of the machine when in storage.
- Make sure the machine is stored away from direct sunlight. Store indoors or in a safe, frost-free area during severe weather and winter months.

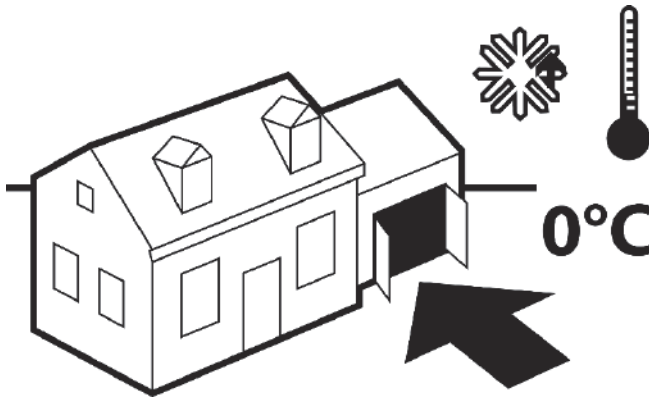

POWER SPARES



No Hassle Returns



Same Day Dispatch*



Over 10,000 Spare Parts



QR Code – Scan the QR code for a direct link to our website

Our Website : power-spares.co.uk

Call us : 01646 404406

Email us : sales@power-spares.co.uk

To maintain your machine in peak operating condition, proper maintenance and care are crucial. Some machines have consumable parts that will need replacement to ensure they continue operating at their full potential. Power-Spares provide manufacturer parts for all your machines, ensuring they remain in peak condition.

About Power Spares

Power-Spares has your back if you damage your lawn mower blade, find your spark plugs not sparking, or snap your recoil. Power-Spares operates under the trading name of Genpower Limited.

As part of the Genpower family, Power-Spares offers you the expertise, efficiency, and quality assurance of a large organisation. We leverage the latest warehousing, distribution, customer service, and inventory management technology to ensure you receive your parts as quickly as possible.

With extensive stock-holding of spare parts in our UK warehouses, Power-Spares is ready to assist you promptly when your machine needs repair. We're Committed to help you get back up and running as quickly as possible.

Technical Data

Machine Specification

Model	HYM3313EGT Grass Trimmer
Voltage	230-240V / 50Hz
Input Power	250W
No Load Speed	12000min ⁻¹
Line Diameter	1.2mm
Cutting Width	22cm
Sound Pressure Level	81.3dB (A)
Sound Power Level	94.4dB (A)
Guaranteed Sound Power Level	96dB (A)
Vibration Level	4.61m/s ²
Weight	1.4kg

Recycling & Disposal

Recycling & Disposal

We do not offer a takeback scheme for the recovery of Waste Electrical Electronic Equipment (WEEE) & Batteries. Instead the responsibility to dispose of WEEE and/or Batteries is passed onto you by us.

So when it becomes necessary to dispose of your machine you must take it to your local Civic Amenity Site. For further information please contact your local Authority for disposal advice.

You MUST make sure that all unused oil and fuel is disposed of correctly either beforehand or at your local Civic Amenity Site.

- Under NO circumstances must any fuel or oil be put down any drains.
- Certain products contain WEEE waste which should not be disposed of in your domestic waste.
- You MUST recycle WEEE in accordance with your local authority or recycling centre.
- Certain products contain batteries which should not be disposed of in your domestic waste.
- You MUST recycle batteries in accordance with your local authority or recycling centre.
- Unwanted packaging and materials should be stored and taken to a recycling centre so it can be disposed of in a manner which is compatible with the environment.

We are a Member of the VALPAK National Compliance Scheme and our registration number is RM08660. For further information about disposal please contact your Local Authority.

You can also get more advice and guidance about recycling at the following website <http://www.recycle-more.co.uk>

Should you pass this product on to another user either sold or loaned, you MUST pass on this user manual. This will make sure that all other users can use and maintain this machine safely.

Environmental Protection

1. Environmental protection should be a priority of considerable importance when using the machine, for the benefit of both social coexistence and the environment in which we live. Try not to cause any disturbance to the surrounding area.
2. You must comply with local regulations and provisions for the disposal of packaging, oils, fuel, filters, damaged parts or any elements which have a strong impact on the environment. This waste must not be disposed of as normal waste. It needs to be separated and taken to specified waste disposal centres where the material will be recycled.
3. You must comply with local regulations for the disposal of waste materials after mowing.
4. When disposing, do not pollute the environment with the machine, but hand it over to a disposal centre, in accordance with the local laws in force.

EU Declaration Of Conformity

Importer and Authorised Representative

Genpower Ltd
Isaac Way, Pembroke Dock, SA72 4RW

Country of Origin: China
Description: Electric Grass Trimmer
SKU Code: HYM3313EGT
Date of Issue: 10/7/2024

Complies to the Following Directives

- Directive 2000/14/EC, Annex VI, and the Directive 2005/88/EC
- Council Directive 2006/42/EC Relating to Machinery
- Directive 2014/30/EU Relating to Electromagnetic Compatibility

Conforming to the Following Requirements and Documents

EN 50636-2-91:2014 | EN IEC 55014-1:2021 | EN IEC 55014 -2:2021
EN IEC 61000-3-2:2019/A1:2021 | EN 61000-3-3:2013/A2:2021
EN 60335-1:2012/A15:2021

Statement of Declaration

We the importer and authorised representative of the product described confirm conformity within the provisions of applicable regulations and directives listed within this document.

Signed on Behalf of Genpower Ltd

Place of Issue: Genpower Ltd

Signatory Name: Roland Llewellyn

Position: Managing Director



RJLlewellyn

Notes



Notes



Useful Information

Check Out Our YouTube Channel

Our videos on YouTube include:

- Unboxing
- Assembly of your machine
- How to service your machine
- Products in use
- 'How To' videos
- Product features

Go to YouTube and search '**Hyundai Power Products**'.

Warranty

Proof of purchase will be required before you make a warranty claim. Full warranty terms and conditions can be found on the HYUNDAI POWER PRODUCTS website: www.hyundaipowerproducts.co.uk

Manual Updates

Our manuals are constantly being reviewed and updated. Should you find an error, omission or something unclear, please contact us for assistance. We reserve the right to make any modifications without prior notice whenever necessary. Our latest manuals are also placed online. All our manuals can be downloaded at: www.hyundaipowerproducts.co.uk

Returning Your Product

If you are returning your product, please contact the dealer for their returns policy.

Leaving A Review

We work very hard to give all of our customers the best possible service. If you have any problems, before leaving negative feedback, please contact us to give us a chance to resolve the issue. We would be delighted if you left us positive feedback! To leave a review, please go to: uk.trustpilot.com/review/hyundaipowerequipment.co.uk

Ordering Spare Parts

You can find the spare part you are looking for at power-spare.co.uk

Product Record

Information

As soon as you have purchased the machine, we recommend that you fill out the following. If you need to contact an authorised dealer or customer service for information on servicing, you may need to provide the following information.

Date Of Purchase:.....

Dealer Name:.....

Dealer Phone:.....

Model Number:.....

Serial/Batch Number:.....



Contact Us

Need Help? Talk To Our Experts

Our friendly aftersales team will be more than happy to help you.



Phone

Call our team on 01646 687 880



Email

aftersales@hyundaipowerproducts.co.uk



Online Live Chat

Go to www.hyundaipowerproducts.co.uk



Post

Genpower Ltd, Isaac Way, Pembroke Dock, Pembrokeshire, SA72 4RW.



Hyundai Support Website

Go to hyundaisupport.co.uk

HYUNDAI

POWER PRODUCTS



GENUINE PRODUCT OF
HYUNDAI CORPORATION

For Inquiries, Please Contact:
GENPOWER LTD
Isaac Way, London Road,
Pembroke Dock, UK, SA72 4RW.
T: +44 (0) 1646 687 880
E: info@hyundaipowerproducts.co.uk
www.hyundaipowerproducts.co.uk

