



operator manual

Impinger Conveyor Oven *Models 3255 & 3270*

This document includes:

- Safety Notices
- Specifications
- Installation Instructions
- Operating Instructions
- Cleaning Instructions
- Warranty Statement



3255 Model Shown

Revision: G
P/N: 20000095



Lincoln Foodservice Products, LLC
1111 North Hadley Road
Fort Wayne, Indiana 46804
United States of America
Technical Support Hotline: (800) 678-9511
Telephone: (260) 459-8200
www.lincolnfp.com

TABLE OF CONTENTS

IMPORTANT WARNING AND SAFETY INFORMATION	3
PURCHASER'S RESPONSIBILITY	4
FEATURES AND OPTIONS – 3255	5
FEATURES AND OPTIONS – 3270	6
EXTERIOR DIMENSIONS – 3255	7
EXTERIOR DIMENSIONS – 3270	8
SPACING REQUIREMENTS	9
VENTILATION GUIDELINES	9
CANOPY VENTILATION RECOMMENDATIONS – 3255	10
CANOPY VENTILATION RECOMMENDATIONS – 3270	11
UNLOADING	12
UNCRATING	12
CODE REFERENCE	13
RESTRAINT REQUIREMENT	13
STAND AND FINGER ASSEMBLY	14
FINGER HOUSING BAFFLE PLATE ADJUSTEMENTS	15
PROGRAMMING	16
MANUAL QUEST ENERGY MANAGEMENT SYSTEM	16
AUTO QUEST ENERGY MANAGEMENT SYSTEM	17
PREVENTIVE MAINTENANCE	18
OPERATOR MAINTENANCE	18
CLEANING INSTRUCTIONS	19
FINGER REMOVAL AND DISASSEMBLY FOR CLEANING	20
CONVEYOR DISASSEMBLY FOR CLEANING	20
CONVEYOR INSTALLATION	20
HOW TO OBTAIN SERVICE	21
FUNCTIONS	21
APPENDIX A – LABEL DEFINITIONS	22
APPENDIX B – MANIFOLD ASSEMBLY ILLUSTRATION (FOR 3270)	24
APPENDIX C – SCHEMATIC (FOR INTERNATIONAL 3255)	25
APPENDIX D – SCHEMATIC (FOR INTERNATIONAL 3270)	26
WARRANTY	27



IMPORTANT WARNING AND SAFETY INFORMATION



NOTE:

This manual contains important safety and installation-operation instructions. Require all operators to read this manual thoroughly before installing, operating or servicing this equipment.



WARNING:

Improper installation, adjustment, alteration, service or maintenance can cause property damage, injury or death. Read the installation, operating and maintenance instructions thoroughly before installing or servicing this equipment.



WARNING:

This appliance is not intended for use by young children or infirm persons unless they have been adequately supervised by a responsible person to ensure that they can use the appliance safely. Young children should be supervised to ensure that they do not play with the appliance.



DANGER!

Do not work around conveyor belt with long hair, loose clothing, or dangling jewelry. Getting caught in the belt could result in serious injury.



DANGER!

For your safety, do not store or use gasoline or other flammable vapors or liquids in the vicinity of this or any other appliance.



DANGER!

Do not spray aerosols in the vicinity of this appliance while it is in operation.



DANGER!

If the power supply cord appears to be damaged, do not attempt to operate the unit. Contact a service agent or qualified electrician to repair!



DANGER!

Do not use parchment paper when placing food product through the toaster! Use of such materials may cause a fire and should never be placed in the toaster.

- Obtain from your local gas provider and post in a prominent location instructions to be followed in the event gas odors are detected.
- It is required that the oven be placed under a ventilation hood to provide for adequate air supply and ventilation.
- Minimum clearances must be maintained from all walls and combustible materials. See "spacing instruction" section for more information.
- Keep the oven free and clear of combustible material.
- Adequate clearance for air openings to the combustion control chamber on the right side of the oven is required.
- Do not obstruct the ventilation holes in the control panels, as these provide the combustion air for the burner and cooling air for the controls.
- The oven is to be operated only on the type of gas and/or electricity as shown on the specification plate.
- The power burner will not operate and gas will not flow through the burner without electrical power.
- This manual should be retained for future reference.
- The electrical wiring diagram is located under the control box covers.

PURCHASER'S RESPONSIBILITY

It is the responsibility of the purchaser:

1. To see that the gas and electric services for the oven are installed on site in accordance with the manufacturers specification.
2. To unload, uncrate, and install the oven in its proper location; in accordance with this installation / operation manual.
3. To see that the gas and electric services are connected properly by a qualified installer of your choice. *For installation in the State of Massachusetts: Installation of this oven must be performed by a licensed plumber or gas fitter.* All such connections must be in accordance with applicable code requirements. Refer to "Code References" section for specific information.
4. To arrange for inspection and operation check-out by an Authorized Service Technician as described below:

Do not attempt to operate the oven until connection of utility service has been fully inspected by an **Authorized Service Technician** or a **Lincoln Foodservice Products, LLC Service Representative**. This service is required by Lincoln Foodservice Products, LLC in order to assist the purchaser in proper start-up of the oven on site. Please note the specific details on the Warranty and make certain connections are made to proper utility services.

The warranty shall not apply if the oven(s) are started up and operated prior to the utilities and oven being inspected and check out made by an Authorized Service Technician or a Lincoln Foodservice Products, LLC Service Representative.

Commented [AKL1]: Update to TOC to be updated automatically

FEATURES AND OPTIONS – 3255

STANDARD FEATURES

- Faster bake times improve time of service.
- Advanced Air Impingement Technology enhances bake quality and uniformity.
- Improved product flow during cooking reduces operation costs.
- Research and Applications support for continued operational success.
- Enodis Star service support is committed to ongoing customer satisfaction.
- New FastBake™ Technology designed to bake up to 35% faster than other conveyor ovens without increased noise levels or loss of product quality!

ELECTRICAL SERVICE

	Voltage (AC)	Phase	HZ.	Amps
Single Oven	120	1	60	6.0
Double Stack	120	1	60	12.0
Triple Stack	120	1	60	18.0
International Ovens (Single Stack)	230/240	1	50	3.15

GENERAL INFORMATION – 3255 NATURAL GAS OVENS

Model	Energy	Power	Voltage	Current	Phase	HZ	Gas Supply Pressure Inches, Water Column	Gas Pipe Size (NPT)
Single Oven	Nat. Gas	145,000 BTU	120 VAC	6 Amps	1	60 Hz	8 – 14	1"
Double Stack	Nat. Gas	290,000 BTU	120 VAC	12 Amps	1	60 Hz	8 – 14	1 ½"
Triple Stack	Nat. Gas	435,000 BTU	120 VAC	18 Amps	1	60 Hz	8 – 14	1 ½"
International (Single Stack)	Nat. Gas (G20, G25)	42.5 kW Hi 147.7 MJ/h	230/240 VAC	3.15 Amps	1	50 Hz	17.4 mbar 1.13 KPa, TPP .84 KPa	1"

GENERAL INFORMATION – 3255 PROPANE GAS OVENS

Model	Energy	Power	Voltage	Current	Phase	HZ	Gas Supply Pressure Inches, Water Column	Gas Pipe Size (NPT)
Single Oven	L.P. Gas	145,000 BTU	120 VAC	6 Amps	1	60 Hz	11.5 – 14	¾"
Double Stack	L.P. Gas	290,000 BTU	120 VAC	12 Amps	1	60 Hz	11.5 – 14	1"
Triple Stack	L.P. Gas	435,000 BTU	120 VAC	18 Amps	1	60 Hz	11.5 – 14	1 ¼"
International (Single Stack)	L.P. Gas (G30, G31)	42.5 kW Hi 147.7 MJ/h	230/240 VAC	3.15 Amps	1	50 Hz	27.4 mbar 2.75 KPa, TPP 2.50 KPa	¾"

Electrical Supply for Australia:

Single Phase: 240VAC, 50Hz / 20 Amp: one neutral & one earth/ground.

Three Phase: 240/415 VAC / 20 Amp; three active, one neutral & one earth/ground.

** In Australia, use a 10 Amp General Purpose Outlet

All ovens require separate service and dedicated neutral.

GAS PRESSURE CONVERSION CHART			
Inches of Water Column	KPa	m-Bar	Millimeters of Water Column
3.5	0.87	8.70	88.9
4.5	1.12	11.2	114.3
7	1.74	17.40	177.8
10	2.48	24.87	254.0
10.5	2.61	26.11	266.7
11	2.73	27.36	279.4
14	3.48	34.81	355.6
14.5	3.61	36.05	368.3

***NOTE: For proper operation, the gas valve requires a nominal inlet pressure of 7 inches H₂O column for natural gas and 11 inches of H₂O column for L.P. gas, unless otherwise specified above. A minimum inlet pressure of 1.0 inch of H₂O above the manifold setting (NAT. manifold 3.5" H₂O, L.P. manifold 10" H₂O) must be maintained with no pressure drop from the no load to full load condition. The maximum inlet pressure must be maintained at or below ½ PSIG (14.5 inches H₂O column). Refer to the chart on the left for pressure conversions.

FEATURES AND OPTIONS – 3270

STANDARD FEATURES

- Faster bake times improve time of service.
- Advanced Air Impingement Technology enhances bake quality and uniformity.
- Improved product flow during cooking reduces operation costs.
- Research and Applications support for continued operational success.
- Enodis Star service support is committed to ongoing customer satisfaction.
- New FastBake™ Technology designed to bake up to 35% faster than other conveyor ovens without increased noise levels or loss of product quality!

ELECTRICAL SERVICE

	Voltage (AC)	Phase	HZ.	Amps
Single Oven	120	1	60	14.0
Double Stack	120	1	60	28.0
Triple Stack	120	1	60	42.0
International Ovens (Single Stack)	230/240	1	50	7.3

GENERAL INFORMATION – 3270 NATURAL GAS OVENS

Model	Energy	Power	Voltage	Current	Phase	HZ	Gas Supply Pressure Inches, Water Column	Gas Pipe Size (NPT)
Single Oven	Nat. Gas	150,000 BTU	120 VAC	14 Amps	1	60 Hz	8 – 14	1"
Double Stack	Nat. Gas	300,000 BTU	120 VAC	28 Amps	1	60 Hz	8 – 14	1 1/4"
Triple Stack	Nat. Gas	450,000 BTU	120 VAC	42 Amps	1	60 Hz	8 – 14	1 1/2"
International (Single Stack)	Nat. Gas	43.9 kW Hi 158.26 MJ	230/240 VAC	7.3 Amps	1	50 Hz	17.4 mbar 1.13 KPa, TPP .88 KPa	1"

GENERAL INFORMATION – 3270 PROPANE GAS OVENS

Model	Energy	Power	Voltage	Current	Phase	HZ	Gas Supply Pressure Inches, Water Column	Gas Pipe Size (NPT)
Single Oven	L.P. Gas	150,000 BTU	120 VAC	14 Amps	1	60 Hz	11.5 – 14	3/4"
Double Stack	L.P. Gas	300,000 BTU	120 VAC	28 Amps	1	60 Hz	11.5 – 14	1"
Triple Stack	L.P. Gas	450,000 BTU	120 VAC	42 Amps	1	60 Hz	11.5 – 14	1 1/4"
International (Single Stack)	L.P. Gas	43.9 kW Hi 158.26 MJ	230/240 VAC	7.3 Amps	1	50 Hz	27.4 mbar 2.75 KPa, TPP 2.50 KPa	3/4"

Electrical Supply for Australia:

Single Phase: 240VAC, 50Hz / 20 Amp: one neutral & one earth/ground.

Three Phase: 240/415 VAC / 20 Amp; three active, one neutral & one earth/ground.

** In Australia, use a 10 Amp General Purpose Outlet

All ovens require separate service and dedicated neutral.

GAS PRESSURE CONVERSION CHART			
Inches of Water Column	KPa	m-Bar	Millimeters of Water Column
3.5	0.87	8.70	88.9
4.5	1.12	11.2	114.3
7	1.74	17.40	177.8
10	2.48	24.87	254.0
10.5	2.61	26.11	266.7
11	2.73	27.36	279.4
14	3.48	34.81	355.6
14.5	3.61	36.05	368.3

***NOTE: For proper operation, the gas valve requires a nominal inlet pressure of 7 inches H₂O column for natural gas and 11 inches of H₂O column for L.P. gas, unless otherwise specified above. A minimum inlet pressure of 1.0 inch of H₂O above the manifold setting (NAT. manifold 3.5" H₂O, L.P. manifold 10" H₂O) must be maintained with no pressure drop from the no load to full load condition. The maximum inlet pressure must be maintained at or below 1/2 PSIG (14.5 inches H₂O column). Refer to the chart on the left for pressure conversions.

EXTERIOR DIMENSIONS – 3255

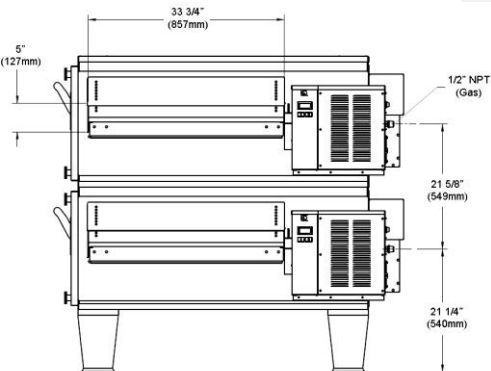
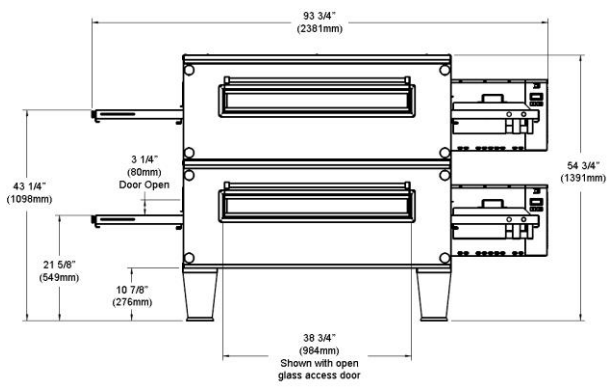
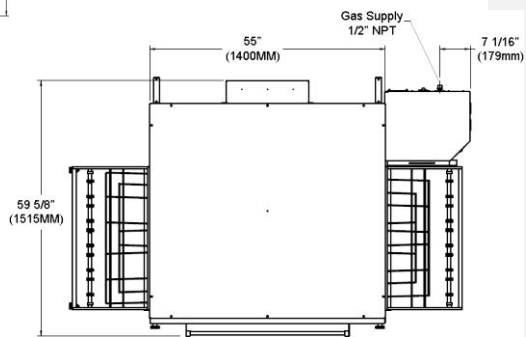
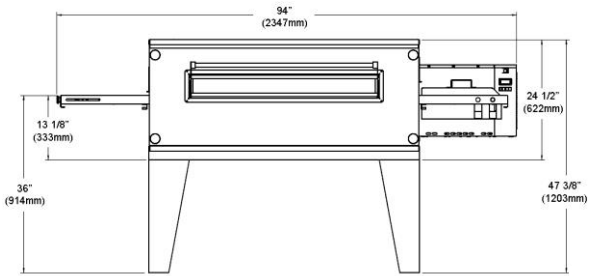

EXTERIOR DIMENSIONS – 3270

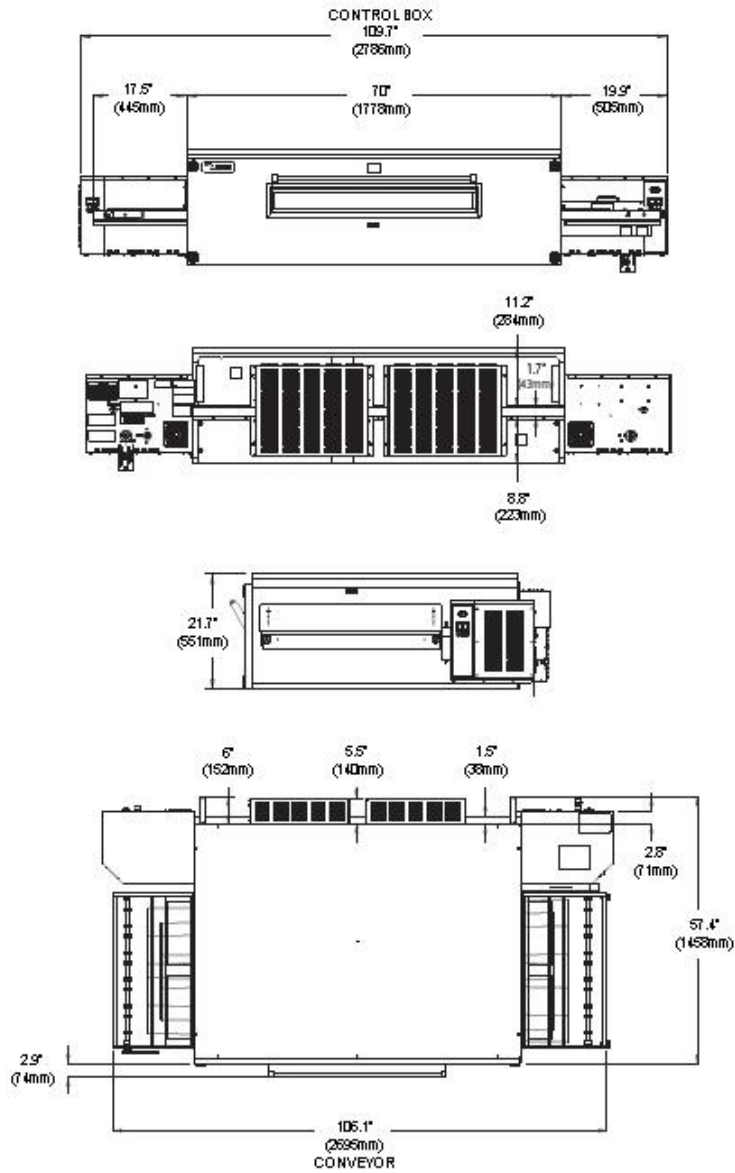

SPACING REQUIREMENTS

The oven must have 6 inches (152 mm) of clearance from combustible surfaces. In case other equipment is located on the right side of oven, a minimum clearance of 24 inches (609 mm) is required from that equipment.

FOR ALL OVENS: A 24-inch (609 mm) clearance at the rear of the oven must be obtainable for service access.
FOR PERMANENTLY INSTALLED OVENS: A permanently installed (unmovable) oven requires a minimum of 13 feet clearance on the right hand side to allow for conveyor removal, cleaning, and servicing.

NOTE: Do not install this (these) oven(s) in any area with an ambient temperature in excess of 95° F / 35° C. Doing so will cause damage to the unit.



CAUTION: This oven must be operated on approved basis only.

VENTILATION

A VENT IS REQUIRED: Local codes prevail. These are the “authority having jurisdiction” as stated by the NATIONAL FIRE PROTECTION ASSOCIATION, INC. in NFPA 96 latest edition. In addition, to be in compliance with the NFPA 54 Section 10.3.5.2, this unit must be installed with a ventilation hood interlock that prevents the unit from operating when the ventilation hood is off. For further ventilation information, see below.

VENTILATION GUIDELINES

A ventilation hood is required to remove heat and cooking odors. For gas ovens, a ventilation hood is also required to remove the products of combustion. The hood and HVAC installation must meet local codes to gain approval by the authority having jurisdiction. Requirements may vary throughout the country depending on the location by city, county, and state. Obtain information from the authority having jurisdiction to determine the requirements for your installation. (Note: This oven is considered as “Light Duty for Baking” when evaluated for code vent requirements.) Obtain information and review copies of codes or documents that will be used to inspect and approve your installation. Your ventilation hood supplier and HVAC contractor should be contacted to provide guidance. A properly engineered and installed ventilation hood and HVAC system will expedite approval and reduce oven maintenance costs. Proper ventilation is the oven owner’s responsibility.

The ventilation hood must operate in harmony with the building HVAC system. It typically requires between 1600 and 2800 CFM exhaust or more with 70% make-up air. (The “Efficiency” of various hood designs makes it necessary to specify such a wide range of ventilator CFM.) Make up air must be supplied by either a hood design or the HVAC system. This will vary with hoods from various manufacturers.

CAUTION: Prevent airflow through the cooking tunnel. Air must NOT be directed onto the oven front or at side of cooking area or rear of oven.

Performance will be evaluated during Start-up Checkout by conducting a smoke candle test. The hood must capture all smoke from the oven. This is required to assure proper performance of the oven and to eliminate additional service calls that occur when ambient temperatures are too high. In all cases, the ambient temperature around the oven must be less than 95° F / 35° C when the oven is operating. In certain localities, other chemical or gaseous methods of detecting adequate capture will be the requirement to meet the local code authority.

For an illustration noting typical guideline information, see “canopy ventilation recommendations” section. Please note, however, that this is not a rigid specification but a guideline. Hood dimensions and the positioning of the hood over the oven will vary with hood manufacturers.

NOTE: Lincoln can provide oven spec sheets that show the dimensions of the oven, KW or BTU ratings and other information that will be useful to both the ventilation hood supplier and the HVAC contractor.

IN AUSTRALIA: Refer to Standard AS 5601. This standard specifies the requirements for piping, flueing, ventilation and appliance installation associated with use of or intended use of fuel gases. The requirements of AS 5601 are to be used in conjunction with, but do not take precedence over, any statutory regulations that may apply in any area.

CANOPY VENTILATION RECOMMENDATIONS – DOUBLE DECK OR SINGLE UNIT IMPINGER 3255

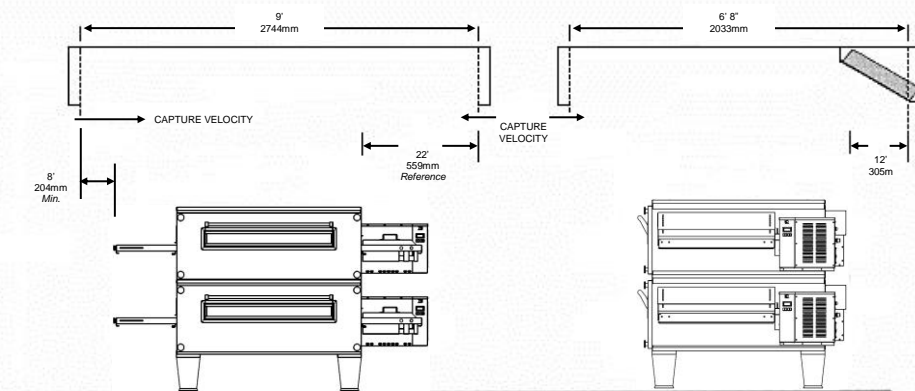

* AFF = Above Finished Floor

VENTILATION SYSTEM VERIFICATION

Note: This oven is considered as "Light Duty for Baking" when evaluated for code vent requirements.

This information is shown as a guideline for ventilating the Impinger 3255 ovens.

1. Dimensions shown are for ovens without extension shelves. The outside end of the conveyor frame must be a minimum of 8 inches inside the canopy as shown.
2. The capture velocity across the lower edge of the canopy is to be 50 FPM at sides and front.
3. Use filters at rear exhaust area of hood, as shown.
4. At startup, the CO level must be checked around the oven space under the canopy. This level must be < 10ppm.
5. The ovens are to be centered in the canopy space left-to-right and front-to-back if possible.
6. A 6-inch space at rear of oven is recommended for utilities.
7. Recommend 1600-2000 CFM exhaust (typical), or higher, as a guideline to obtain adequate capture velocity.
8. Recommend 70% make-up air provided outside of the canopy through perf metal diffusers directed straight down - not at the oven; located at front, sides or both.
9. Room air diffusers must not be directed onto the oven and should be positioned a minimum of 3-feet from the perimeter of the hood to keep them from affecting the oven.

CANOPY VENTILATION RECOMMENDATIONS – DOUBLE DECK OR SINGLE UNIT IMPINGER 3270

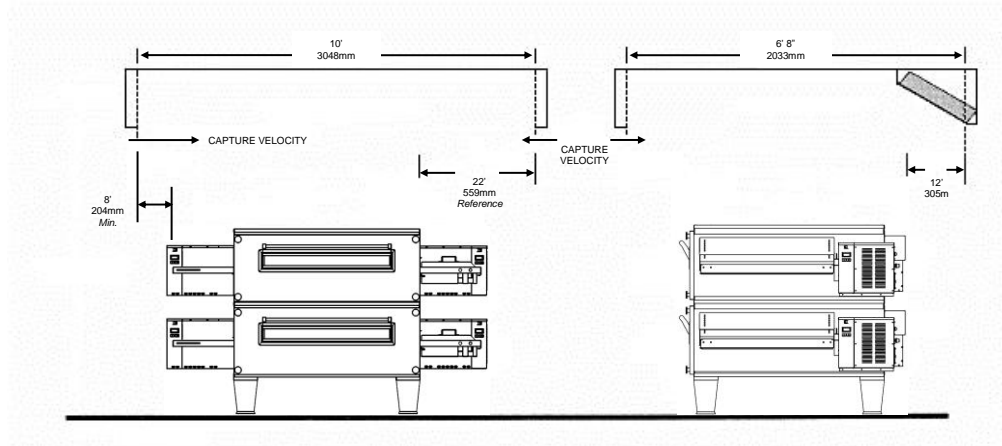

* AFF = Above Finished Floor

VENTILATION SYSTEM VERIFICATION

Note: This oven is considered as "Light Duty for Baking" when evaluated for code vent requirements.

This information is shown as a guideline for ventilating the Impinger 3270 ovens.

1. Dimensions shown are for ovens without extension shelves. The outside end of the conveyor frame must be a minimum of 8 inches inside the canopy as shown.
2. The capture velocity across the lower edge of the canopy is to be 50 FPM at sides and front.
3. Use filters at rear exhaust area of hood, as shown.
4. At startup, the CO level must be checked around the oven space under the canopy. This level must be < 10ppm.
5. The ovens are to be centered in the canopy space left-to-right and front-to-back if possible.
6. A 6-inch space at rear of oven is recommended for utilities.
7. Recommend 1800-2400 CFM exhaust (typical), or higher, as a guideline to obtain adequate capture velocity.
8. Recommend 70% make-up air provided outside of the canopy through perf metal diffusers directed straight down - not at the oven; located at front, sides or both.
9. Room air diffusers must not be directed onto the oven and should be positioned a minimum of 3-feet from the perimeter of the hood to keep them from affecting the oven.

GENERAL INFORMATION

The instructions that follow are intended as a guide for preparing for the installation of the Impinger® Conveyor Ovens, Series 3255 & 3270.

First and foremost, each crate should be examined before signing the Bill of Lading to report any visible damage caused by the trucker in transit, and to account for the proper number of crates.

UNLOADING

When the oven arrives it should consist of:

1. A crate containing oven body, conveyor, fingers, crumb pans, and pan stops. (Some models may have the conveyor packed separately.)
2. A package containing the stand and top.

It is recommended that you have a material-handling device available to unload.

DO NOT LIFT EXCESSIVE WEIGHT!

IF THERE IS APPARENT DAMAGE:

UNITED STATES AND CANADA: Arrangements should be made to file a claim against the carrier, as Interstate Commerce Regulations require that the consignee initiate a claim.

ALL SHIPMENTS TO OTHER COUNTRIES: Freight terms will be developed and extended on an individual basis.

Proper and secure storage facilities should be arranged for the oven(s). If necessary, protect it from outdoor or damp conditions at all times before installation.

UNCRATING

When you have all the crates unloaded, open the crates and remove the plastic covers. Inspect at once for concealed damage. If anything appears to be damaged, contact the appropriate persons immediately to file a damage claim. After completing this inspection, finish unpacking the oven and all other components. **Be sure to remove the cardboard from the plenum shroud.** Move all components inside near the area where they will be assembled in the order in which they will be assembled.

THE OVEN WILL CLEAR THROUGH A 30" (762 mm) DOORWAY BY USING THE FOLLOWING PROCEDURE:

- A. Remove conveyor; see "Conveyor Removal" section for instructions. (Some units may have conveyor packed separately.)
- B. Remove thumb screws and baffle from the left side of the oven.
- C. Place the left side on a four wheel moving dolly and it will clear a 30" (762 mm) doorway. Or oven can remain on skid and be tilted on its back. Then placed on two four wheel dollies.

EXTERIOR DIMENSIONS

Gas and electrical services should be located as shown below. If flexible services are provided, they must meet code requirements for such installation.

MANUAL GAS VALVE INSTALLATION

When installing the gas valve that is supplied with the oven it is our suggestion that an elbow be placed on the oven pipe first. This will allow the flexible hose to be attached in a downward direction eliminating possible stress to the hose.

SPECIFICATIONS

Body: Stainless Steel

Power: Gas and/or Electric

DB Level: \leq 71 dba

Operating Temperature Range: 300° - 600° F (149° - 316° C)



WARNING **INT'L (CE):**

Parts protected by the manufacturer or agent shall not be adjusted by the installer.

The gas supply tubing shall comply with the national requirements in force and shall be periodically examined and replaced as necessary



**WARNING
INT'L (CE):**

This appliance must be properly grounded at time of installation. Failure to ensure that this equipment is properly grounded can result in electrocution, dismemberment or fatal injury.

CODE REFERENCE

GAS CODE REFERENCE

Safe and satisfactory operation of this oven depends to a great extent upon its proper installation, and it should be installed, as applicable in accordance with the National Fuel Gas Codes, ANSI Z223.1/NFPA 54, latest version, Manufacturers' installation Instructions and local municipal building codes.

1. The oven and its individual shut off valve must be disconnected from the gas supply piping system during any pressure testing of that system at test pressures in excess of ½ psig (3.45kPa).
2. The oven must be isolated from the gas supply piping system by closing its individual manual shut off valve during any pressure testing of the gas supply system at test pressures equal to or less than ½ psig (3.45kPa).

IN MASSACHUSETTS: The minimum length of a flexible gas supply hose is thirty-six (36") inches.

IN CANADA: The installation of these appliances is to be in accordance with CSA B.149.1 latest version – Natural Gas and Propane Installation Code – and/or local codes.

IN AUSTRALIA: To be installed in accordance with AS 5601-2004 and 4563-2004 Gas Installation Code.

NOTE: In the event that verification of pilot flame is needed, a small mirror may be utilized for verification.

ELECTRICAL CODE REFERENCE

When installed, this appliance must be electrically grounded and its installation must comply with the National Electric Code, ANSI-NFPA 70, latest edition, the Manufacturers' Installation Instructions, and applicable local municipal building codes.

IN CANADA: All electrical connections are to be made in accordance with CSA C22.2 latest version – Canadian Electrical Code and/or local codes.

ALL OTHER COUNTRIES: Local gas and/or electrical codes will prevail.

1. Strain Relief is provided with each oven. International Dealer/Distributors provide applicable power cord/plug for each customer.
2. All pole disconnection switch 3mm open contact distance.
3. To prevent electrical shock, an equal potential bonding ground lug is provided in the back. This allows the oven to be connected to an external bonding system.
4. If used as double or triple stack and each oven has its own disconnection switch, all switches should be close together.

RESTRAINT REQUIREMENT – GAS OVEN(S) ON CASTERS, U.S. AND AUSTRALIA

1. The installation shall be made with a gas connector that complies with the Standard for Connectors for Movable Gas Appliances, ANSI Z21.69 latest version, and a quick disconnect device that complies with the Standard for Quick Disconnect Devices for Use With Gas Fuel, ANSI Z21.41 latest version.

IN CANADA: The installation shall be made with gas connectors that comply with Canadian Code CSA 6.16 latest version and quick disconnects complying to Canadian Code CSA 6.9 latest version.

IN AUSTRALIA: To be installed in accordance with AS 5601-2004 and 4563-2004 Gas Installation Code.

2. The installation of the restraint must limit the movement of the oven(s) without depending on the connector, the quick disconnect device or its associated piping to limit the oven movement.
3. If the restraint must be disconnected during maintenance or cleaning, it must be reconnected after the oven has been returned to its originally installed position.

OPERATIONS

1. Screw lifting eye "B" of cable assembly to hole "A".
2. Screw eye bolt "C" of cable assembly to stud in wall "D" or floor anchor "E".

NOTE: Installation point is the same for single and double stack oven(s).

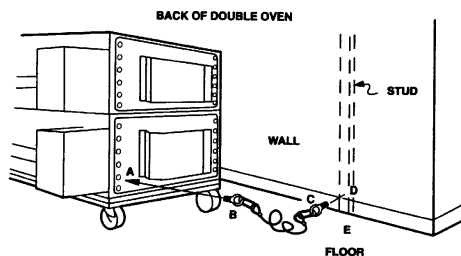

STAND AND FINGER ASSEMBLY (WITH 3255 FOR ILLUSTRATION)

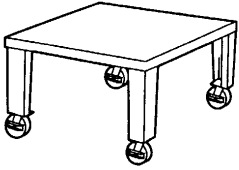

1. The stand is a 55" (1397 mm) x 49" (1245 mm) rectangle. Set it in place with a 55" side facing out. This will be the front of the oven. Using a carpenter's level, level all four (4) sides of the stand. To raise or lower the stand use the leg adjusters. Ovens on casters require a level floor. NOTE: The oven top is packed with oven stand. Remove top from stand before assembly.

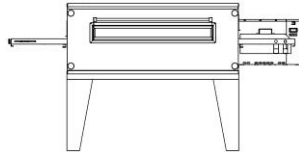

2. Remove the oven from the dolly and set it on the stand. The control panel should be on the right rear as you face the oven. Be sure that the oven sets squarely on the stand and is fully seated. For a single oven, install top. For double, see step 3.

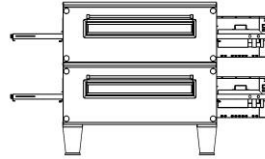

3. If you purchased a double stack oven, place the second oven on top of the first one. Be sure that it sets on squarely and is fully seated. The control panel goes on the right rear. Now install oven top.

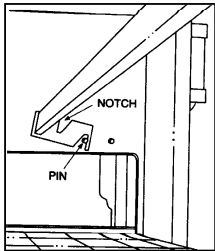

4. Before installing the retaining brackets in the oven(s), be sure all of the packing material is removed from the plenum shroud. Install the finger retaining brackets by placing them upside down and hooking the retaining pin as shown above.

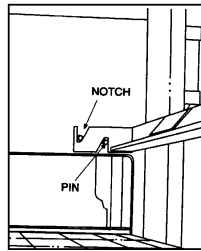

5. Rotate the finger brackets until the notches in the brackets sit on the retaining pins.

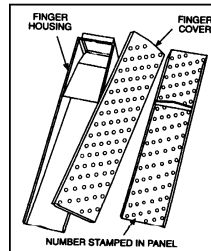

6. Assemble fingers as shown in steps 7 and 8.

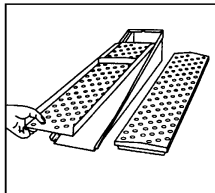

7. Insert columnating plate so the step goes under the lip of the finger housing and the plate lies flush with the housing side edge.

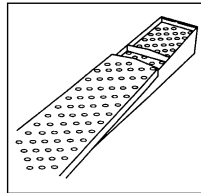

8. Install cover by sliding it on the small end.

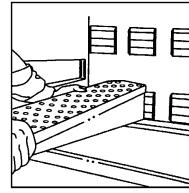

9. Insert assembled finger through door opening starting with lower left. NOTE: The customer MUST tell you what position to place the assembled finger in, for their application.

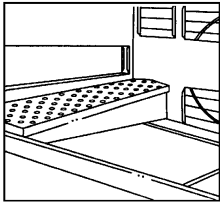

10. Install finger in the oven by sliding it over the plenum flange and setting the front bracket. BE SURE THAT THE FINGER SETS SQUARELY OVER THE PLENUM FLANGES AND THE HOLES POINT IN THE PROPER DIRECTION. Top fingers point down, bottom fingers point up.

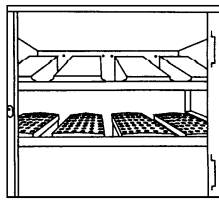

11. Repeat step 10 until all ten (10) fingers are installed.

Install conveyor and crumb pans before operation. See "conveyor installation" section for instructions.

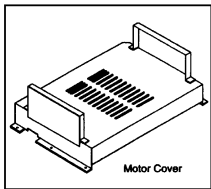

12. Attach Motor Cover as shown with bolts provided.

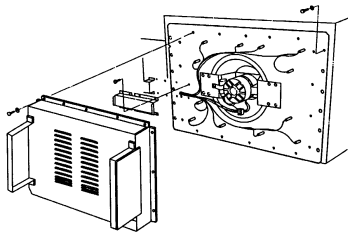

You are now ready for services to be connected. This should be done by licensed electricians and plumbers. See "specifications" section and "code references" section for more information.

13. The gas piping manifold kit should be installed as shown to the right.

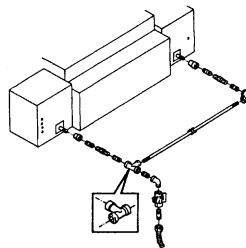

NOTE: See Appendix B for detailed information on the Manifold Assembly.

FINGER HOUSING BAFFLE PLATE ADJUSTMENTS

The finger housing has a baffle mounted inside to balance the air flow to the rear and front of the oven. If the product is cooking more or less in the rear of the oven than in the front, it is possible the finger housing baffle needs to be adjusted. If it is deemed necessary to adjust the air balancing baffle, be sure to adjust all ten (10) finger housing to exactly the same opening. Determine if more air (heat) is required at front or rear of oven then open or close off that air by bending the baffle in the proper direction. For additional information on how to adjust the Finger Housing Baffle Plate, contact the Lincoln Technical Service Department at (800) 678-9511.

PROGRAMMING

OVEN START-UP INSTRUCTIONS

1. Turn oven on. After the oven is turned on it is in cooking mode. To set the time and temperature you must be in programming mode.
2. To get to program mode, press and hold the time and temperature buttons for approximately 6 seconds. While pressing the buttons the display will say "Hold Key and Wait." The display will then say "Please Release" after the buttons have been held long enough. After you release the buttons you will be in programming mode.
3. The display will say "Set Point Temperature or Time to Select Function." If no buttons are pressed within 4 seconds the display will revert back to cooking mode. It will automatically save the last settings that were entered before reverting to cooking mode.
4. To set the temperature, press the temperature button. The set point temperature will be displayed and the temperature may be increased or decreased by pressing the increase or decrease buttons.
5. To set the belt time, press the time button. The display will indicate which belt is being set. Press the increase and decrease buttons to increase or decrease time. Press the time button again to toggle between belts.
6. To save settings and return to cooking mode leave the control alone for 4 seconds and it will revert to cooking mode.

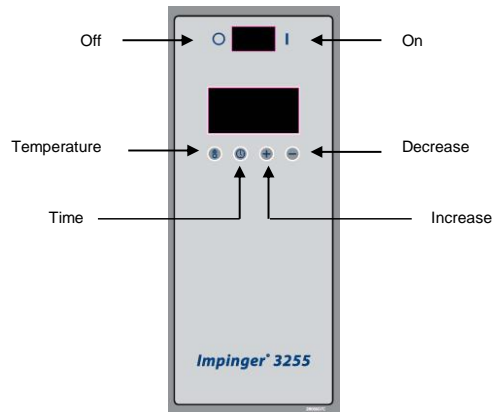

Note: While this illustration features the 3255 display panel, the 3270 display panel includes a similar design.

TO TURN A CONVEYOR OFF OR BACK ON

1. When the oven is turned on all belts will automatically begin running. To turn one belt off, press and hold one of the buttons.
2. While pressing the button the display will show which belt is being turned off. You will need to continue holding the button for approximately four seconds.
3. The display will show "Please Release" when it is time to let go of the button. The belt will turn off.
4. To turn the belt back on, press and hold the same button that you did before.

OVEN SHUT-DOWN INSTRUCTIONS

1. Turn the ON/OFF switch to the "OFF" position. The oven will now shut down and cease operation.

MANUAL QUEST ENERGY MANAGEMENT SYSTEM OPERATING INSTRUCTIONS (OPTIONAL)



1. Press button on control box side panel to illuminate button and engage the Quest energy savings option. The oven is now in energy savings mode.
2. To bring the oven out of energy saving mode, simply press the button again to allow for normal operation. When the oven is in normal operating mode, the side panel button is no longer illuminated.

NOTE: When starting up the oven after the Quest system has been installed, the main fan may take upwards of sixty seconds to begin running. This is normal operating procedure.

AUTO QUEST ENERGY MANAGEMENT SYSTEM OPERATING INSTRUCTIONS

(OPTIONAL)– (AUTO QUEST MODELS ONLY)



AutoQuest is designed to provide energy savings automatically when the oven is not being utilized for extended periods of time yet maintain normal operating temperature for immediate use when needed. Currently, AutoQuest will activate after 14 minutes of inactivity during normal daily operation or 34 minutes after the unit is first turned on in the morning (20 minute oven warm-up + 14 minutes). When AutoQuest has been activated the following will occur:

- Conveyor Belt will stop moving
- Fan Motor will slow down (noticeably quiet)
- Quest light will illuminate green (located on right side of control box)

In order to bring the oven back to normal operation, simply place food on the input side of the conveyor or open the access door and place the item in the oven. AutoQuest sensors will note the placement of food product on the end of the conveyor or when opening the access door. Sensor activation starts the conveyor and raises the rpm of the main fan motor, thus returning the oven to normal operation. The AutoQuest light will not be illuminated while oven is in normal operation.

NOTE: Care should be taken to place the food item entirely on the conveyor to avoid the "blind spots" located on conveyor end (see illustration below).



CAUTION: If you wish to change the conveyor direction, it is important to turn the oven off and restart to allow for proper sensor readings.

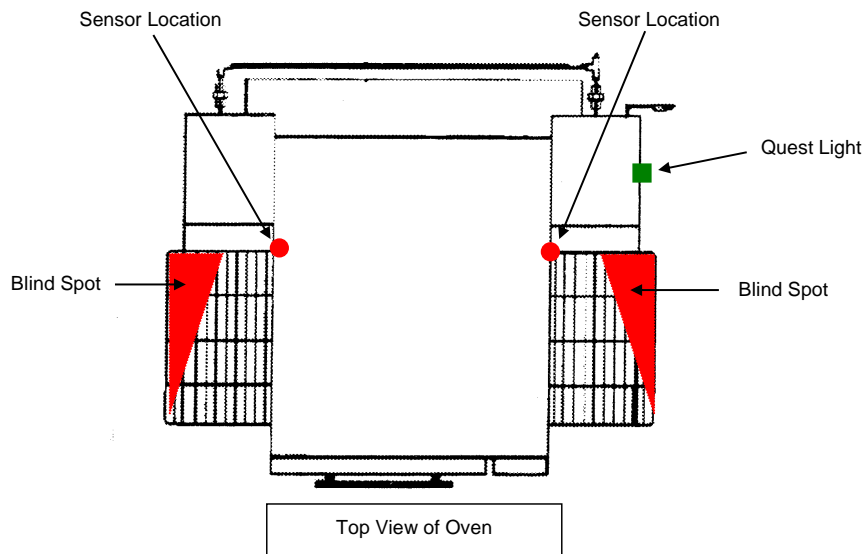

INFORMATION ON USE OF OVEN

The Impinger® oven functions by directing high velocity streams of heated air directly on the food products. Because air is the heat source, it is effective even on sensitive foods. Compared to conventional ovens and even convection ovens, the cooking time of products in the Impinger® Conveyor ovens can be as much as two (2) to four (4) times faster. Several factors may affect the cooking time of any special product such as: 1) oven temperature setting, 2) conveyor speed, 3) position of columnnating plate in oven, and 4) adjustments of the 2 baffles on the conveyor openings.

We encourage you to experiment with the oven by trying different temperature settings and belt speeds. Also, try to control the cooking of the product by re-arranging the optional columnnating plates.



WARNING:

Do not work around conveyor with long hair, loose clothing, or dangling jewelry. Getting caught in the belt could result in serious injury.

PREVENTIVE MAINTENANCE

Although this oven has been designed to be as trouble-free as possible, periodic preventive maintenance is essential to maintain peak performance. It is necessary to keep the motors, fans, and electronic controls free of dirt, dust and debris to insure proper cooling. Overheating is detrimental to the life of all components mentioned. The periodic intervals for preventive cleaning may vary greatly depending on the environment in which the oven is operating. You must discuss the need for preventive maintenance with your Authorized Service Agency to establish a proper program. If there are any questions that the service agency cannot answer, please contact Lincoln Foodservice Technical Service Department at (800) 678-9511.

OPERATOR MAINTENANCE



DANGER:

Disconnect power supply before servicing or cleaning this unit. Safeguard power so it cannot be accidentally restored. Failure to do so could result in serious injury. There is more than one power supply connection point when ovens are stacked, so make sure that all switches are in "OFF" position before cleaning or maintenance.

To maintain maximum efficiency of the oven, it is necessary to keep it clean, all ventilation louvers on the oven must be cleaned regularly. Oven use and type of product will actually determine the frequency of cleaning. The conveyor drive chain should be checked during the weekly cleaning cycle to see if it has become loose. Loose chain operation will DAMAGE the conveyor drive motor.

If the oven fails to operate, check the circuit breaker to be sure it is turned on. Also, check the fuses on the control panel to be sure that they are good before you call the Authorized Service Agency. The name and phone number of the Authorized Service Agency should be located at the bottom of the data plate.

CLEANING INSTRUCTIONS



CAUTION: Unit must be cool to touch and disconnected from power source prior to cleaning. Do not use power-cleaning equipment, steel wool, or wire brushes on stainless steel or painted surfaces.

DAILY

1. Clean exterior surfaces of the oven by wiping it down with a mild detergent and clean water, or a commercial stainless cleaner.
2. Clean crumb pans and guards by washing with a mild detergent solution and rinsing with clean water.
3. Clean the interior by sweeping up all loose particles, then wash with a mild detergent solution and rinse with clean water.
4. Clean the conveyor belt by wiping with a clean cloth or brushing with a soft wire brush. Lincoln catalog #369217.

NOTE: DO NOT USE A CAUSTIC OR ALKALINE BASE CLEANER ON INTERIOR OF THE OVEN. THIS WILL RUIN THE ALUMINIZED FINISH OF THE OVEN INTERIOR.

On exterior of oven, deposits of baked-on splatter, oil, grease, or light discoloration may be removed with any of several commercial cleaners. Consult with your local supplier.



WARNING: When using cleaning solutions, be sure they meet local and national health standards.

WEEKLY

1. Remove fingers, disassemble and clean. See "Finger Removal" section for more information.
2. Remove conveyor, disassemble and clean. See "Conveyor Disassembly" section for more information.

NOTE: Be sure to clean and inspect the ventilation hood in accordance with the ventilation hood manufacturer's specifications.

FINGER REMOVAL AND DISASSEMBLY FOR CLEANING

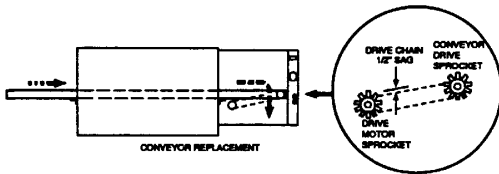

1. Open door and remove upper fingers. Note any particular placement of fingers that you may have, such as fully closed, half-closed, or fully open, columnating plates.
2. With oven door closed, remove conveyor and then remove bottom fingers.
3. For finger disassembly, see "Stand and Finger Assembly" section.
4. Reassemble fingers in reverse order with the step of the columnating plate facing downward so it fits under the lip of the finger housing.
5. Re-install finger in oven. Be sure that they are fully seated over the plenum flanges and the holes are pointing toward the conveyor.

CONVEYOR DISASSEMBLY FOR CLEANING

TO REMOVE CONVEYOR FROM OVEN

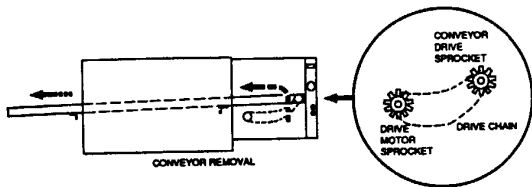

1. Remove conveyor chain guard. Remove crumb pans.
NOTE: Prior to step 2, ensure oven door is closed. Trying to remove the conveyor without the door in place is very difficult and may cause damage to the unit.
2. Lift right end of conveyor and push in approximately 3" (76mm). Remove drive chain.
3. Pull conveyor out the right end. Place on table or work surface.

CONVEYOR INSTALLATION



CAUTION:

Set tension on the conveyor belt. The belt should be able to be lifted enough to allow it to be $\frac{1}{4}$ " (6 mm) from the top of the conveyor opening on the oven. Do not over tighten the belt!

NOTE: Ensure front door is in place prior to installing the conveyor. Trying to install the conveyor without the door in place is very difficult and may cause damage to the unit.

1. Insert the conveyor through the opening in the right side. Sprocket should be to the right side of the conveyor.
2. Slide conveyor through the oven chamber until the locking bar on the drive end of the conveyor is approximately 2" – 3" (50 – 76 mm) into the oven chamber. Install drive chain by placing it over the drive sprocket and placing it over the conveyor sprocket.
3. Lift conveyor just enough to allow you to pull the conveyor toward you until the locking bar is outside of the oven cavity, at the same time push the conveyor downward so that the bar locks on the outside of the oven wall.
4. Reinstall conveyor crumb pans and chain guard cover.

DO NOT ATTEMPT TO OPERATE THE OVEN until connection of utility service and installation has been fully inspected (START-UP CHECKOUT) by an Authorized Service Technician or a Lincoln Foodservice Products, LLC Service Representative. This service is required by Lincoln Foodservice Products, LLC in order to insure the oven(s) is properly installed and in working order. The warranty becomes effective upon verification of proper installation.

The warranty shall not apply if the oven(s) are started up and operated prior to the "START-UP CHECKOUT" being performed by an Authorized Service Technician or a Lincoln Foodservice Products, LLC Service Representative.



WARNING: If the supply cord appears to be damaged, do not attempt to operate unit. Contact service agent or qualified technician to repair.

HOW TO OBTAIN SERVICE

If the oven fails to operate, check the circuit breaker to be sure it is turned on (on a gas oven check the manual gas valve to insure it is in the ON position) and check the fuses on the back of the oven to be sure they are good before you call the Authorized Service Agency. The name and phone number of the Authorized Service Agency should be located on the oven or contact the factory at (800) 678-9511 for the name of the nearest agency.

FUNCTIONS

THERMAL CUT-OUT SWITCH FOR CONTROL BOX COMPONENTS

These ovens include a "safety thermal cut-out switch" for your protection. This safety related device is designed to insure that the unit will not overheat and damage the oven. In the unlikely event that the oven would exceed the specified operating temperature range, the "safety thermal cut-out switch" will activate, thus blocking power to the unit and causing it to turn off.



CAUTION: In order to avoid a hazard due to inadvertent resetting of the thermal cutout, this appliance must not be supplied through an external switching device, such as a timer or connected to a circuit that is regularly switched on and off by the utility.

APPENDIX A – LABEL DEFINITIONS



CAUTION – HOT SURFACE



CLOCK, TIME SWITCH, TIMER



TRANSFORMER



DANGEROUS VOLTAGE



EQUIPOTENTIALITY GROUND



PROTECTIVE EARTH GROUND



EARTH GROUND



CHANGE FUSES



FUSE



POWER OFF



POWER ON



DISCONNECT POWER



TEMPERATURE, HEAT

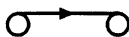

CONVEYOR



FAN



BRENNER

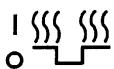

HEAT CYCLE



READY, TIMER INDICATOR



RESET



HIGH TEMPERATURE, HEAT

APPENDIX A – LABEL DEFINITIONS (CONT'D)

A AMPS

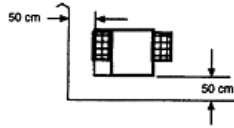

SERVICE ACCESSIBILITY, PROVIDE MINIMUM REAR AND SIDE CLEARANCE

V VOLTS



ORIFICE – MAIN

kw KILOWATTS / HR



ORIFICE – LOW FIRE

 TYPE OF GAS

 AC

 ½ COOK TIME



APPENDIX B – MANIFOLD ASSEMBLY ILLUSTRATION (FOR 3270)

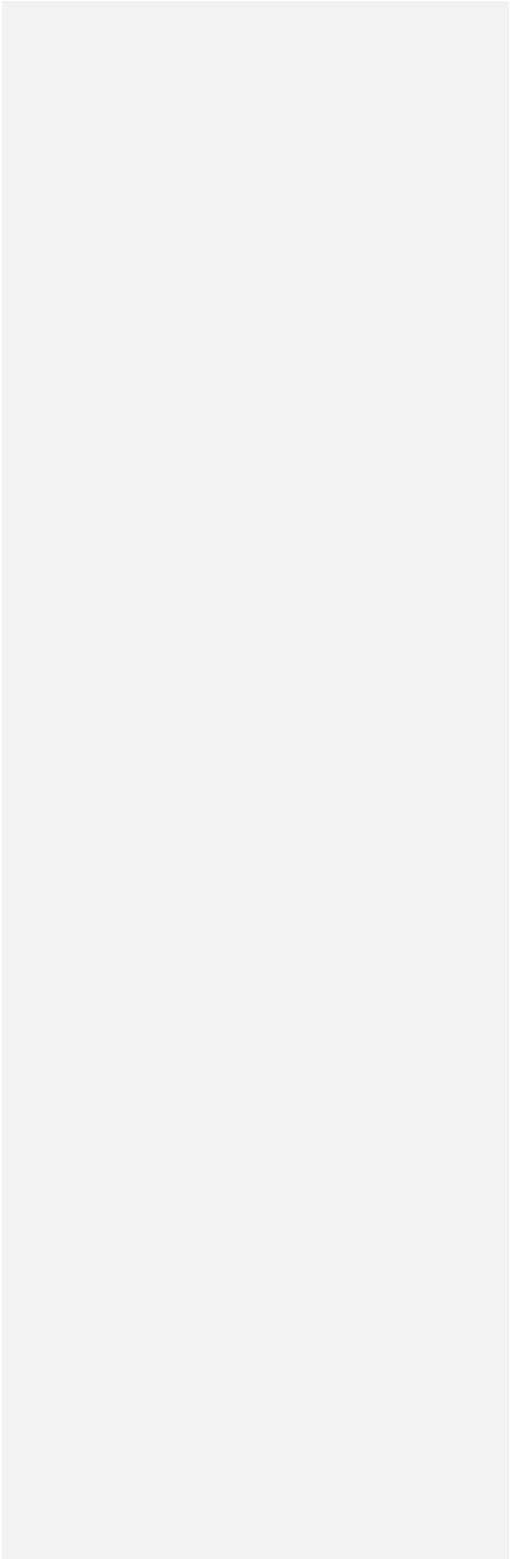
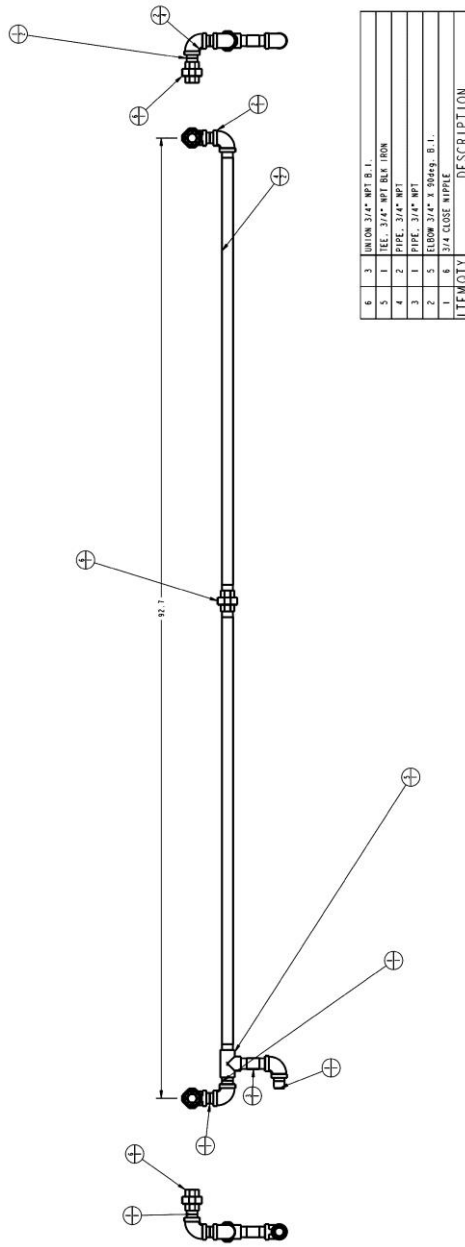

APPENDIX C – SCHEMATIC (FOR INTERNATIONAL 3255)

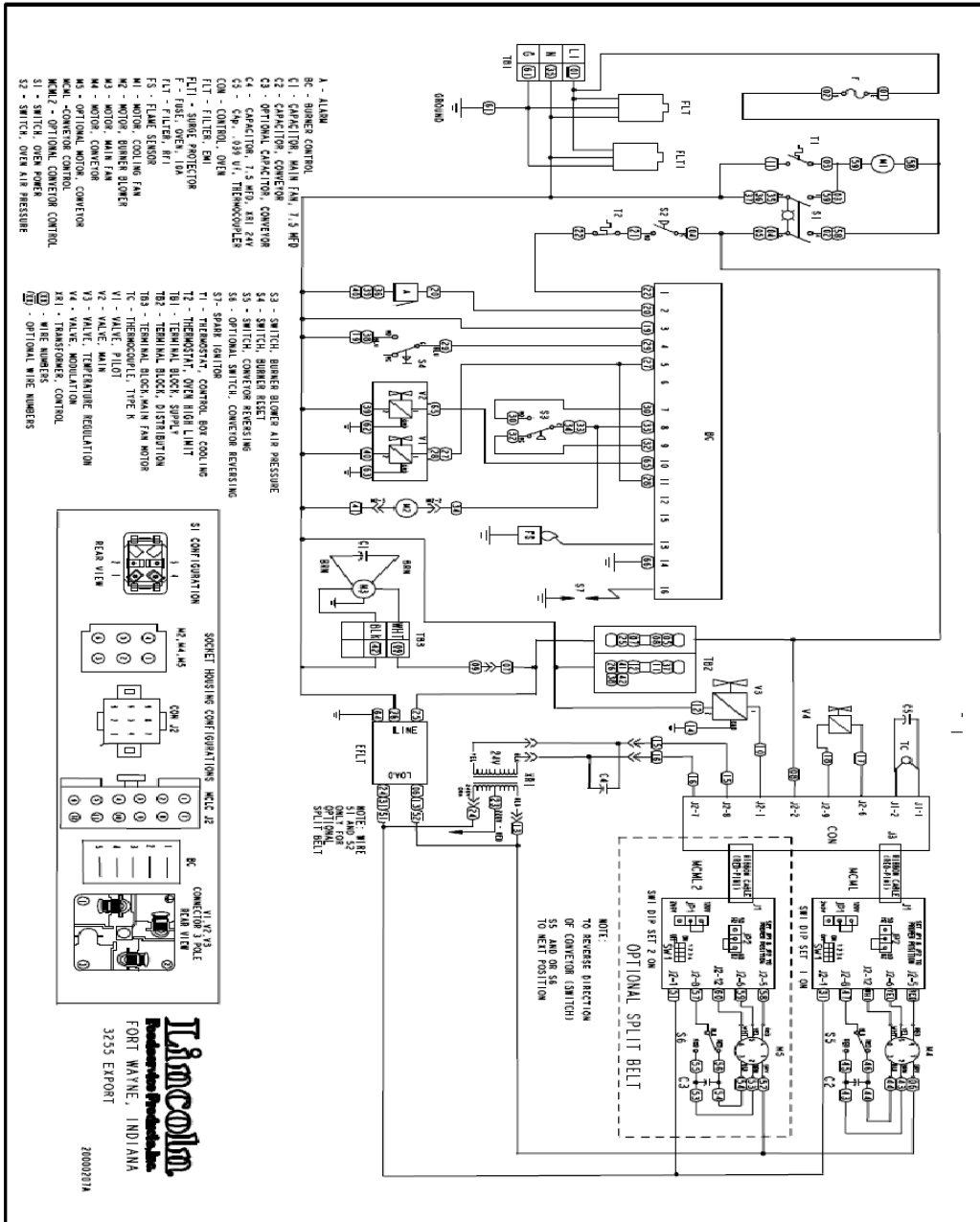

APPENDIX D – SCHEMATIC (FOR INTERNATIONAL 3270)

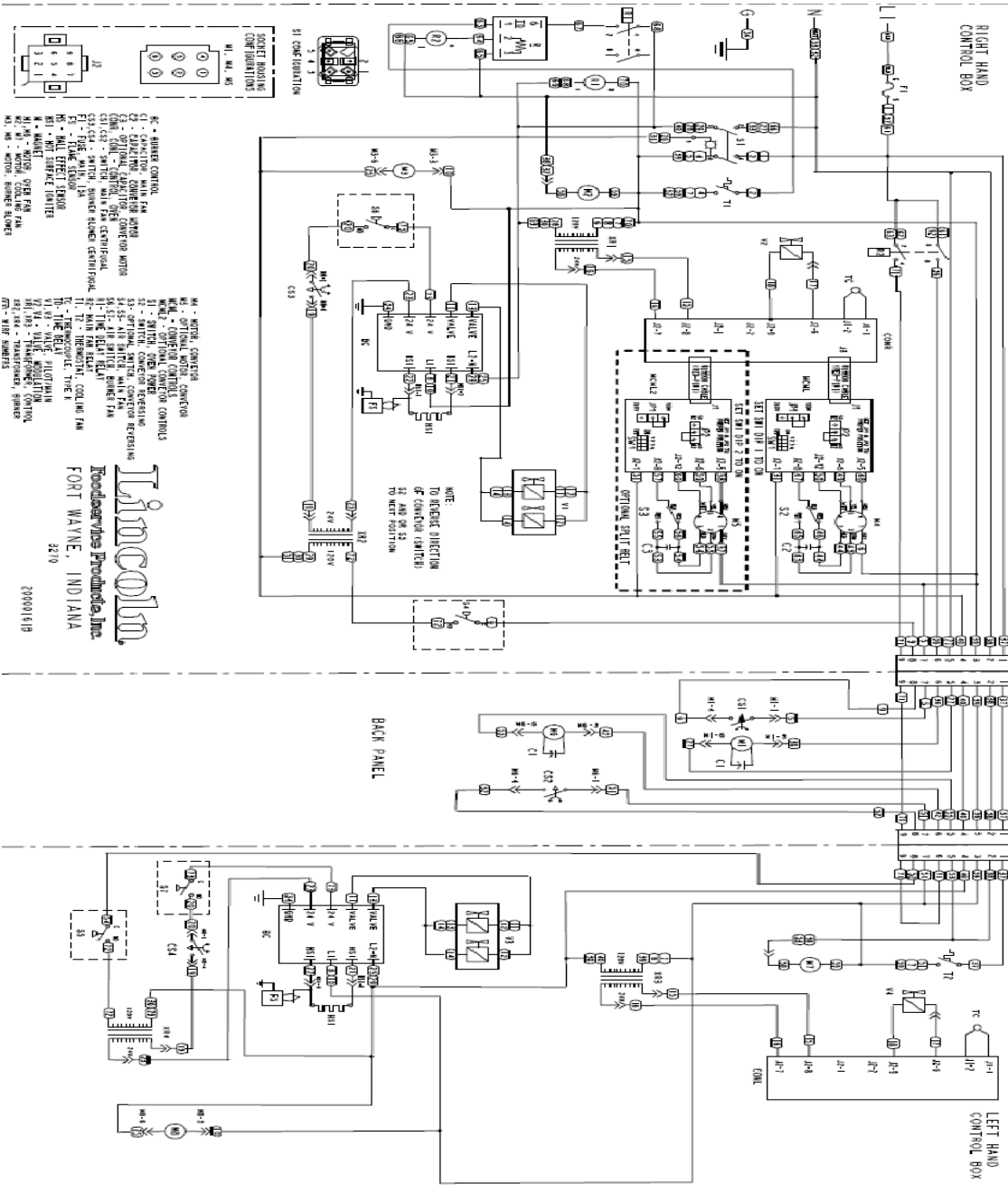

Lincoln
 Foodservice Products, Inc.
 FORT WAYNE, INDIANA
 3210
 20001118

LIMITED WARRANTY FOR COMMERCIAL PRODUCTS

LIMITED WARRANTY

Lincoln Foodservice Products, LLC ("Lincoln") warrants this product to be free from defects in material and workmanship for a period of one (1) year from the date of purchase.

During the warranty period, Lincoln shall, at Lincoln's option, repair, or replace parts determined by Lincoln to be defective in material or workmanship, and with respect to services, shall re-perform any defective portion of said services. The foregoing shall be the sole obligation of Lincoln under this Limited Warranty with respect to the equipment, products, and services. With respect to equipment, materials, parts and accessories manufactured by others, Lincoln's sole obligation shall be to use reasonable efforts to obtain the full benefit of the manufacturer's warranties. Lincoln shall have no liability, whether in contract, tort, negligence, or otherwise, with respect to non-Lincoln manufactured products.

WHO IS COVERED

This Limited Warranty is available only to the original purchaser of the product and is not transferable.

EXCLUSIONS FROM COVERAGE

- Repair or replacement of parts required because of misuse, improper care or storage, negligence, alteration, accident, use of incompatible supplies or lack of specified maintenance shall be excluded
- Normal maintenance items, including but not limited to, light bulbs, fuses, gaskets, O-rings, interior and exterior finishes, lubrication, conveyor belt, motor bushes, broken glass, etc. adjustments and calibrations for temperatures, speed and air flows
- Failures caused by improper or erratic voltages
- Improper or unauthorized repair
- Changes in adjustment and calibration after ninety (90) days from equipment installation date
- This Limited Warranty will not apply to any parts subject to damage beyond the control of Lincoln, or to equipment which has been subject to alteration, misuse or improper installation, accidents, damage in shipment, fire, floods, power changes, other hazards or acts of God that are beyond the control of Lincoln
- This Limited Warranty does not apply, and shall not cover any products or equipment manufactured or sold by Lincoln when such products or commercial equipment is installed or used in a residential or non-commercial application. Installations not within the applicable building or fire codes render this Limited Warranty and any responsibility or obligations associated therein null and void. This includes any damage, costs, or legal actions resulting from the installation of any Lincoln commercial cooking equipment in a non-commercial application or installation, where the equipment is being used for applications other than those approved for by Lincoln.

LIMITATIONS OF LIABILITY

The preceding paragraphs set forth the exclusive remedy for all claims based on failure of, or defect in, products or services sold hereunder, whether the failure or defect arises before or during the warranty period, and whether a claim, however instituted, is based on contract, indemnity, warranty, tort (including negligence), strict liability, implied by statute, common-law or otherwise, and Lincoln its servants and agents shall not be liable for any claims for personal injuries, incidental or consequential damages or loss, howsoever caused. Upon the expiration of the warranty period, all such liability shall terminate. THE FOREGOING WARRANTIES ARE EXCLUSIVE AND IN LIEU OF ALL OTHER WARRANTIES, WHETHER WRITTEN, ORAL, IMPLIED OR STATUTORY NO IMPLIED WARRANTY OF MERCHANTABILITY OR FITNESS FOR PARTICULAR PURPOSE SHALL APPLY. LINCOLN DOES NOT WARRANT ANY PRODUCTS OR SERVICES OF OTHERS.

REMEDIES

The liability of Lincoln for breach of any warranty obligation hereunder is limited to: (i) the repair or replacement of the equipment on which the liability is based, or with respect to services, re-performance of the services; or (ii) at Lincoln's option, the refund of the amount paid for said equipment or services.

Any breach by Lincoln with respect to any item or unit of equipment or services shall be deemed a breach with respect to that item or unit or service only

WARRANTY CLAIM PROCEDURE

Customer shall be responsible to:

- Immediately advise the Dealer or Lincoln's Authorized Service Agent of the equipment serial number and the nature of the problem.
- Verify the problem is a factory responsibility. Improper installation or misuse of equipment, are not covered under this Limited Warranty.
- Cooperate with the Service Agency so that warranty service may be completed during normal working hours.
- Travel Time not to exceed two hours and mileage not to exceed one hundred (100) miles.

GOVERNING LAW

Limited Warranty shall be governed by the laws of the state of Delaware, USA, excluding their conflicts of law principles. The United Nations Convention on Contracts for the International Sale of Goods is hereby excluded in its entirety from application to this Limited Warranty

Lincoln Foodservice Products, LLC
1111 North Hadley Road
Fort Wayne, Indiana 46804
USA
www.lincolnfp.com



