

electriciQ

User manual

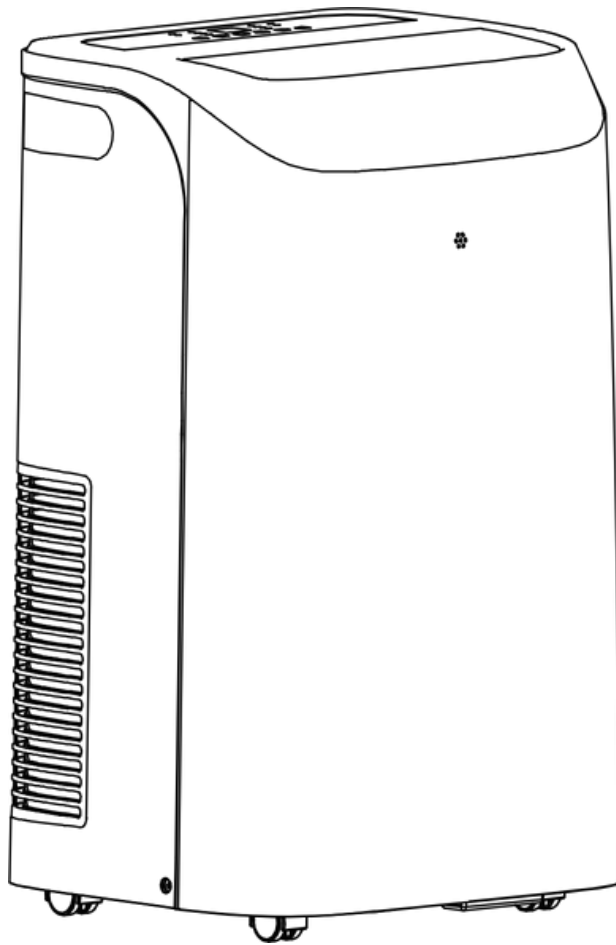

14,000 BTU PORTABLE SMART WiFi AIR CONDITIONER P15CW

Thank you for choosing electriciQ.
Please read this user manual before using this innovative Air Conditioner and keep it safe for future reference.

Visit our page, www.electriQ.co.uk, for our entire range of Intelligent Electricals.

Welcome to electriQ

We hope you're happy with your new purchase.

We'd love to see how you're getting on.

If you share any snaps on your socials,
make sure you tag us and use our hashtag.



@electriQUK
#electriQUK

We're here to help

Got a question or need help?

Get in touch with our friendly customer service team.



0330 390 3061

support@electriQ.co.uk

Mon - Fri | 9am to 5pm

**Unit 2A, Trident Business Park, Neptune Way,
Leeds Road, Huddersfield, HD2 1UA**

CONTENTS

SAFETY WARNINGS	4
PRODUCT OVERVIEW	7
PARTS	7
INSTALLATION	8
OPERATION	11
REMOTE CONTROL	12
WiFi SMART CONTROL	14
CLEANING AND MAINTENANCE	24
EMPTYING THE INTERNAL WATER TANK	24
TECHNICAL SPECIFICATION	25
PRODUCT FICHE	26
ERROR CODES	26
TROUBLESHOOTING	27
SUPPORT	29





SAFETY INSTRUCTIONS



Important!

- Carefully read the instructions before operating the unit.
- This appliance is for indoor use only.
- Rating: This unit must only be connected to a 220-240 V / 50 Hz earthed outlet. The fuse rating can be found on the plug itself.
- Installation must be in accordance with the applicable regulations of the country where the unit is used.
- If you have any doubt about the suitability of your electrical supply, have it checked and, if necessary, modified by a qualified electrician.
- This appliance is not intended for use by persons (including children) with reduced physical, sensory or mental capabilities. It is also not intended for use by those with a lack of experience and knowledge unless they have been given supervision or instruction concerning the use of the appliance by a person responsible for their safety.
- Children should be supervised to ensure that they do not play with the appliance.
- You must follow the venting and set-up instructions; Incorrect operation can result in damage to the unit, which is not covered under your warranty.
- This air conditioner has been tested and is safe to use. However, as with any electrical appliance, use it with care.
- This appliance is designed for personal comfort and as such should not be left operating unattended for prolonged periods.
- Do not obstruct any of the ventilation openings.
- The airflow should never be restricted, for example, by venting the unit into a condenser box or reducing the hose diameter, as this can damage the unit.
- Disconnect the power from the appliance before dismantling, assembling or cleaning.
- An authorised service representative should perform any service other than regular cleaning or filter replacement. Failure to comply could result in a voided warranty.
- Avoid touching any moving parts of the appliance.
- Never insert fingers, pencils or any other objects through the guard.
- **WARNING:** Do not pierce or burn any part of the unit.
- Do not clean the unit by spraying it or immersing it in water.
- Never connect the unit to an electrical outlet using an extension cord. If an outlet is not available, one should be installed by a qualified electrician.
- Never operate this appliance if the cord or plug is damaged. Ensure the power cord is not stretched or exposed to sharp objects/edges.
- A damaged supply cord should be replaced by the manufacturer or a qualified electrician to avoid a hazard.
- **CAUTION:** In order to avoid a hazard due to inadvertent resetting of the thermal cut-out, this appliance must not be supplied through an external switching device, such as a timer, or connected to a circuit that is regularly switched on and off by the utility.
- Do not use the appliance for any purpose other than its intended use.

- The air conditioner unit must always be stored and transported upright; otherwise, irreparable damage may be caused to the compressor. If there is doubt, we suggest waiting at least 24 hours before starting the unit.
- Avoid restarting the air conditioning unit unless 3 minutes have passed since being turned off. This prevents damage to the compressor.
- Never use the mains plug as a switch to start and turn off the air conditioning unit. Use the provided POWER button located on the control panel.
- Always place the unit on a dry, stable, flat surface.
- The appliance should not be installed in the laundry or wet rooms.
- The appliance must be placed in a room without sources of ignition (for example, open flames, an operating gas appliance or an operating electric heater).
- R290 refrigerant gas complies with European environmental directives.
- R290 has a low GWP (Global Warming Potential) of 3.
- This air conditioner contains around 305g of R290 refrigerant gas.
- Do not use or store in an unventilated space with an area smaller than 14.6 m² per unit. Smaller room sizes may be suitable if other safety measures are implemented and a risk assessment conducted. The room must be designed to prevent the stagnation of possible refrigerant leaks, as there could be a fire or explosion hazard if the refrigerant comes into contact with electric heaters, stoves, or other sources of ignition.
- **WARNING:** The appliance must be stored in a room without continuously operating ignition sources, for example, open flames, an operating gas appliance or electric heaters.
- The room must be such as to prevent stagnation of possible leaks of refrigerant gas, as there could be a danger of fire or explosion should the refrigerant come into contact with electric heaters, stoves or other ignition sources.
- Only store and use the unit whilst upright; do not lay it down or tip it.
- Do not place the unit near any ovens or other heat sources. This may be dangerous, and will make the unit work harder and use more energy.
- Do not place the unit in direct sunlight; this can affect its appearance and cause it to work harder and be less energy efficient.
- Refrigerant gas may be odourless.
- Do not use the product and contact the retailer for advice if damage has occurred to the unit, which may have compromised the refrigerant system.
- Any repairs or maintenance must only be conducted by a suitably qualified engineer. Before opening and servicing the unit, the authorised engineer must possess a copy of the manufacturer's service manual and follow the safety information contained within it to ensure all hazards are minimised.
- The refrigerant system should not be perforated or punctured.
- At the end of the unit's lifetime, always dispose in line with local regulations.
- Ensure all storage conditions in the manual are followed.
- **WARNING:** Do not use means to accelerate the defrosting process or to clean the unit.

	<p>WARNING: This appliance contains flammable refrigerant. If this leaks and comes into contact with an external ignition source, there is a fire risk.</p>
	<p>CAUTION: The operation manual should be read thoroughly.</p>
	<p>CAUTION: Any service personnel working on the unit should read the service manual before work.</p>
	<p>CAUTION: Information on operation and servicing is in the manual.</p>

ENERGY SAVING AND UNIT SAFETY PROTECTION TIPS

- Do not cover or restrict the airflow from the outlet or inlet grilles.
- For maximum performance, the minimum distance from a wall or object should be 45cm.
- Keep the filters clean. Under normal conditions, filters should only need cleaning once every three weeks (approximately). Since the filters remove airborne particles, more frequent cleaning may be necessary, depending on the air quality.
- For the initial start-up, set the fan speed to maximum and the thermostat to 5 degrees lower than the current temperature. Afterwards, set the fan switch to low and set the thermostat to your desired setting.
- To protect the unit, we recommend not using the cooling function when the ambient temperature exceeds 35°C. The unit's performance may be affected at lower temperatures than this. If a scorching day is predicted, running the unit overnight in the desired room is recommended.

FEATURES

- 3 in 1 Cooling, Fan, Dehumidifier.
- 3-speed fan: Balancing quiet operation with performance.
- 24 Hours Start / Stop Timer.
- Digital Thermostat.
- Remote Control.
- Castors for Enhanced Portability

PRODUCT OVERVIEW

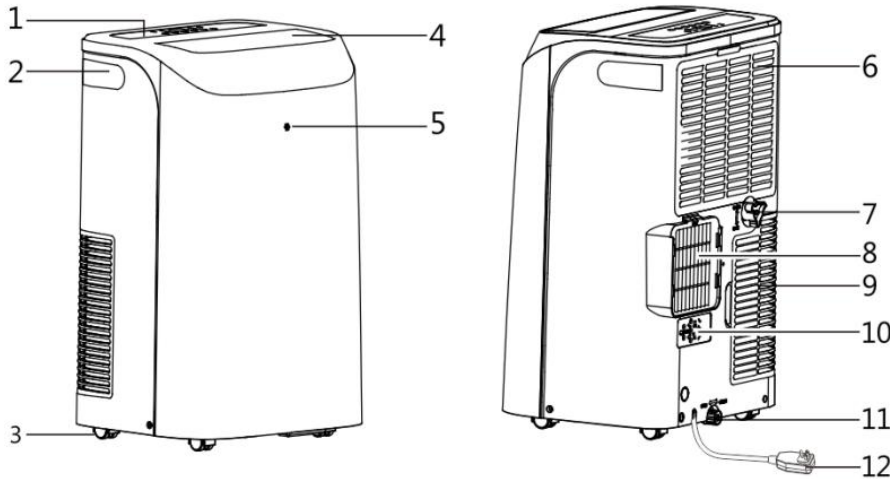

No.	DESCRIPTION
1	Control Panel
2	Handle
3	Castors
4	Louvre
5	Remote Control Receiver
6	Intake Grille
7	Middle Drainage
8	Air Outlet Grille
9	Intake Grille
10	Plug Holder
11	Condenser Drain
12	Power Cable

PART LIST

IMAGE	DESCRIPTION	QTY
	Exhaust hose, Outlet adaptor and Fishtail adaptor	1
	Window slide bar	1
	Metal locking screw	2
	Remote	1
	Drainage hose	1

IMPORTANT: All diagrams in the manual are for illustration purposes only.

INSTALLATION

WARNING: Before using this unit, please keep it upright for at least 3-4 hours.

This unit can easily be moved from one room to another. While moving the unit, please keep it upright and place it on an even surface.

FITTING THE EXHAUST HOSE TO THE UNIT

IMPORTANT: The exhaust hose only needs to be fitted in cooling mode and auto.

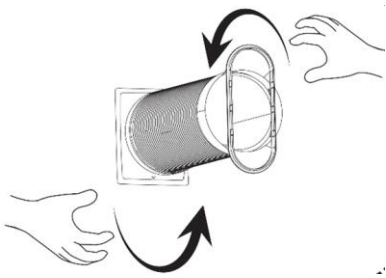

- 1) Attach the fishtail connector to the end of the hose by extending the end and twisting until firmly attached (At least 3 full rotations).
- 2) Attach the Hose to the Outlet adaptor in the same way by extending the end and twisting until firmly attached (At least 3 full rotations).

- 3) Slide the Outlet adaptor into position on the rear of the unit.

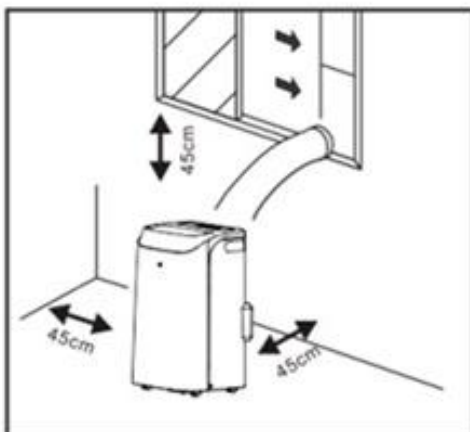
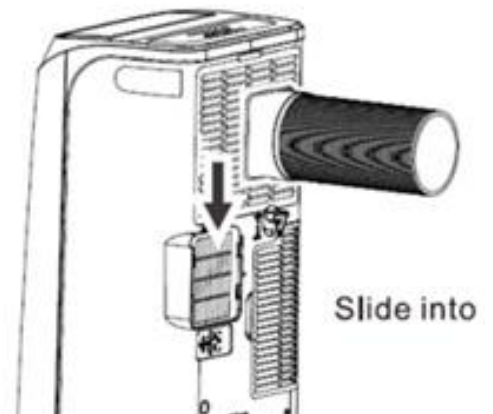

- 4) Make sure the unit is upright, and there are no obstructions to the air inlets and outlet grilles, with at least 45cm of space to the sides and rear of the unit. Failure to allow adequate space for the appliance's air intake can reduce performance and, in severe cases, cause the unit to freeze.

FITTING THE WINDOW KIT

The window slide bar has been designed to fit most standard vertical and horizontal window applications; however, you may need to modify some installation procedures for certain types of windows.

1. Slide panel B into A, and place it in your window.
2. Slide the panels apart until they are the full width of the window opening.
3. Use the 2 screws supplied to secure the window slide bar through the corresponding holes.
4. Clip the Fishtail adaptor into the window slide bar, and close the window onto the window slide bar to close the window opening (which will prevent hot air from re-entering the room)

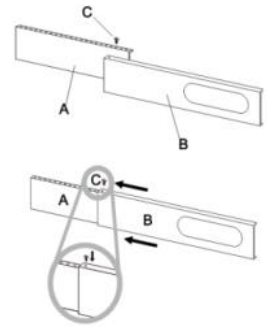

NOTES:

- The window kit is only designed to be installed with sliding or sash windows or doors. The window kit is not designed to be used with any other window style, although it may be possible to modify it to work with other windows.
- The fishtail adaptor can be used without the window slide bar with most windows/doors.
- When using the air conditioner, ensure that the opening around the fishtail adaptor is as small as possible to ensure the unit's efficiency is not reduced.
- The best form of installation is through a wall duct. By adequately venting, you expel hot air from your room while efficiently cooling it.
- Your air conditioner should be used without the vent pipe in dry mode. When using dry mode, ensure an external water tank is used, monitored, and regularly emptied to prevent overflow.

IMPORTANT SAFEGUARDS

The length of the soft hose extends from approximately 30 cm to 180 cm. If the hose is extended above this length, the unit may malfunction, which can invalidate the warranty. The outlet vent must be well-ventilated and unobstructed, or the unit will overheat. Keep the hose as straight and short as possible and avoid bending the air hose by more than 30 degrees to maintain the unit's performance. Excessive bends in the hose may prevent the unit from expelling hot air, leading to internal damage and invalidating the warranty.

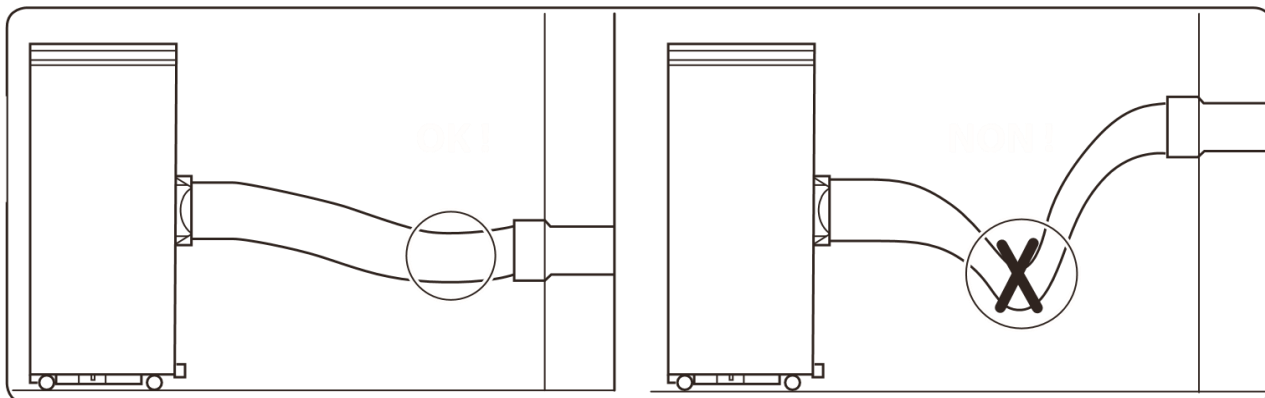

OPERATION

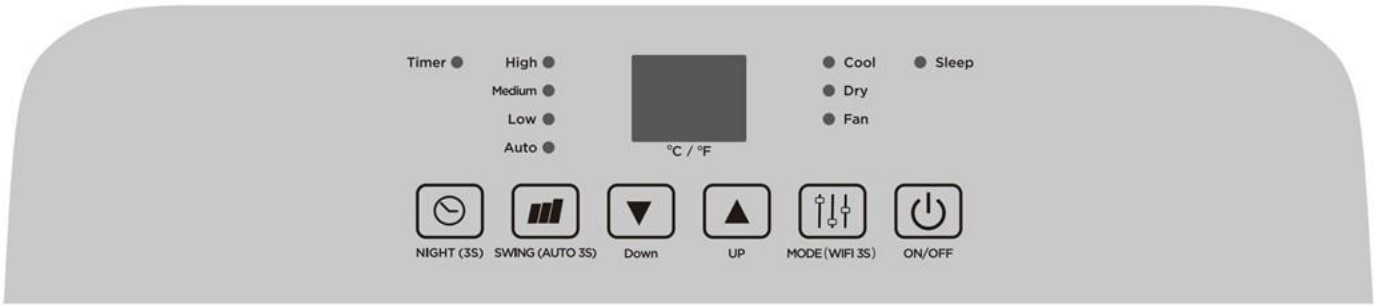









	<p>ON/OFF: Press once to turn the unit on and once to turn it off. After the first use, the unit will remember the last mode used, and that mode will be active when you turn the unit on again.</p>
	<p>MODE: Press repeatedly to cycle through available modes. The relevant indicator will be illuminated to show the mode currently selected.</p> <p>COOL: Then use the UP and DOWN buttons to select your desired room temperature. The temperature can be set between 16°C and 31°C. The fan speed can be adjusted using the speed button.</p> <p>FAN: You do not need the exhaust attached in this mode, but you can keep it attached if you like. Press the mode button until the fan indicator is illuminated. The fan speed can be adjusted using the Speed button.</p> <p>DRY: This mode is ideal for reducing the humidity in your home. To prevent the unit from cooling the room, it is advisable to set it up for continuous drainage without the exhaust pipe. The temperature can be set between 16°C and 31°C, and should be set below the current room temperature for the compressor to work.</p> <p>AUTO: In Auto mode, the appliance runs in an energy-saving profile. The temperature is preset to 23° C, and once this is reached, the fan speed automatically reduces to maintain it with minimal energy use. If the room temperature rises, the fan speed will increase to bring it back to the target temperature. Auto mode is not the primary cooling function but an energy-saving mode. If you need active cooling below 23°C, please select Cooling mode instead.</p> <p>WiFi: In standby, hold the mode button for 3 seconds to turn WiFi on to Quick Connection mode.</p>
	<p>UP: Press to increase the desired room temperature and extend the timer duration.</p>
	<p>DOWN: Press to decrease the desired room temperature and shorten the timer duration.</p>
	<p>SPEED: Press repeatedly to cycle through the fan speeds. There are 3 speeds: High, Medium and Low. Repeatedly press the speed button to cycle through the speeds. Note: The extraction fan supplying the vent hose automatically adjusts its speed based on internal temperatures.</p> <p>SWING: With the unit operating with the desired settings, hold the speed button for 3 seconds. This will turn on the automatic swing function. The louvres will move and adjust airflow to ensure even distribution across the room. To turn off and lock the louvres in their current position, hold the speed button for 3 seconds.</p>
	<p>SWITCH BETWEEN CELSIUS / FAHRENHEIT</p>
	<p>Hold down the up and down buttons for 3 seconds to switch the appliance between Fahrenheit and Celsius temperature display.</p>

LOUVRES ADJUSTMENT

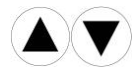
You can manually adjust the louvres to change the airflow direction. Carefully adjust using your hand to your desired position.

REMOTE CONTROL



 ON/OFF	This works the same as the unit's power button.
 UP and DOWN	These function the same as the unit's up and down buttons.
 SPEED	Fan Button - This functions the same as the unit's speed button.
 MODE	This functions the same as the unit's mode button.
 SWING	Activates and deactivates the swing function.
 LIGHT	This will turn the display light on and off.
 TIMER	Used to set the power on or power off timer, adjusting the duration with the UP and DOWN buttons.
 SLEEP	This function is only available on the remote when the unit is in Cool or Dry modes. When activated, it will reduce the fan speed and dim the display. The unit will increase the desired room temperature by 1 degree per hour for 2 hours, then maintain it for 6 hours before turning the appliance off.

IMPORTANT: The remote will not work if you are further than 7 metres away. Always point the remote at the unit in use. Ensure the batteries are securely installed in the remote when in use.

REPLACING THE BATTERIES

Remove the battery cover, insert 2 x AAA batteries following the correct polarity, then reattach the battery cover securely. Do not use the remote if the battery cover does not securely attach.



MULTI PROTECTIVE FUNCTIONS

FROST PROTECTION

In COOL, AUTO and DRY modes, if the exhaust temperature is too low, the machine will automatically stop until the temperature rises.

OVERFLOW PROTECTION

When the water in the internal water tank exceeds the warning level, the machine will stop operating and sound an alarm with the LCD showing "HL". To resume operation, empty the internal water tank. After emptying the water, the machine will automatically return to its original state.

AUTO-DEFROST

The machine has an automatic defrosting function. If the internal coils' temperature drops too low during operation, the unit will enter auto defrost, and the heating symbol will flash on the control panel.

AUTOMATIC THERMAL PROTECTION

To protect the machine's service life, it features automatic thermal protection. If the temperature within the unit is outside of the specified range, the compressor and the lower motor will stop operation. After the machine's temperature returns to normal, the appliance will automatically resume regular operation.

COMPRESSOR PROTECTION

There is a 3-minute delay in starting the protection function to prevent damage to the compressor.

POWER DOWN MEMORY

If power is cut to the unit, upon restoration, the air conditioner will resume operation with the same settings as before the power interruption (after the compressor protection period).

NOTE: Any timer set before the power interruption will not be saved.

WiFi SMART CONTROL

BEFORE YOU START

- Ensure your router provides a standard 2.4 Ghz connection.
- If your router is dual-band, ensure that both networks have different network names (SSID). Your router / Internet service provider can provide specific advice for your router.
- Place the air conditioner as close as possible to the router during setup.
- Once the app has been installed on your phone, turn off the data connection, and ensure your phone is connected to your router via WiFi.

DOWNLOAD THE APP TO YOUR PHONE

Download the "TUYA SMART" app from your chosen app store, using the QR codes below, or by searching for the app in your chosen store.



Android



IOS

CONNECTION METHODS AVAILABLE FOR SETUP

The air conditioner has two different setup modes, EZ (Quick Connection) and AP (Access Point). The quick connection is a simple way to set up the unit. The AP connection uses a direct local WiFi connection between your phone and the air conditioner to upload the network details.

Before starting the setup, with the air conditioner plugged in, but turned off, press and hold the MODE button for 5 seconds (until you hear a beep) to enter the WiFi connection mode.

Please ensure your device is in the correct WiFi connection mode for the connection type you are attempting; the WiFi light on your air conditioner will flash to indicate the correct mode.

Connection Type	Frequency of Flashes
EZ (Quick Connection)	Flashes twice per second
AP (Access Point)	Flashes once per second

CHANGING BETWEEN CONNECTION TYPES

To change the unit between the two WiFi connection modes, hold the MODE button for 5 seconds until you hear a beep.



REGISTER THE APP

1. Press on the Sign Up button at the bottom of the screen.

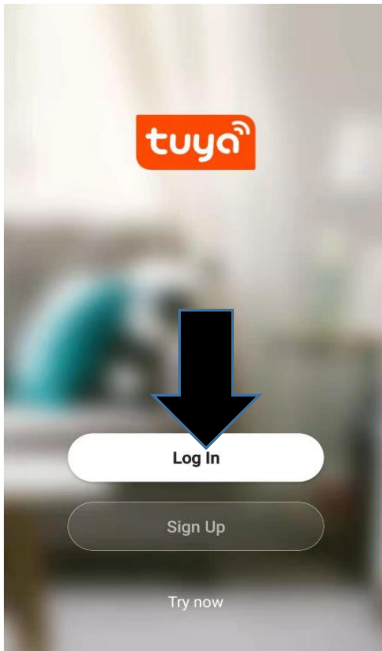

2. Read the Privacy policy and press the Agree Button.

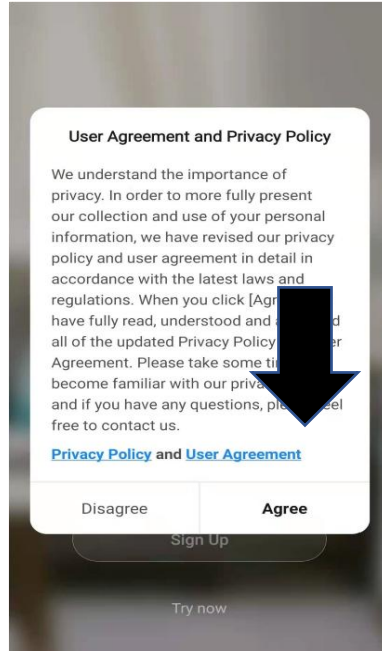

3. Enter your email address or phone number and press continue to register.

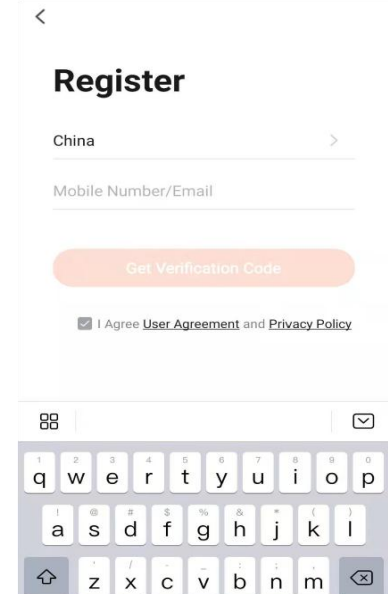

4. A verification code will be sent by the method selected in step 3. Enter the code into the app.

<

Verification Code

Verification code has been sent to:
Resend(57s)

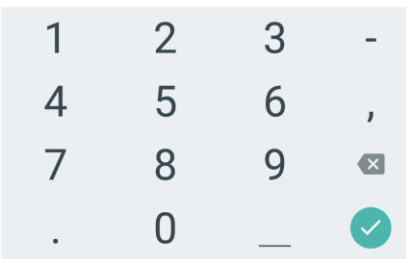

5. Type in the password you would like to create. This needs to be 6-20 characters, with letters and numbers.

<

Set Password

Password must contain 6-20 letters and numbers

Done

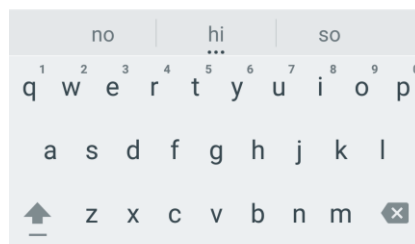

6. The app is now registered. It will automatically log you in following registration.

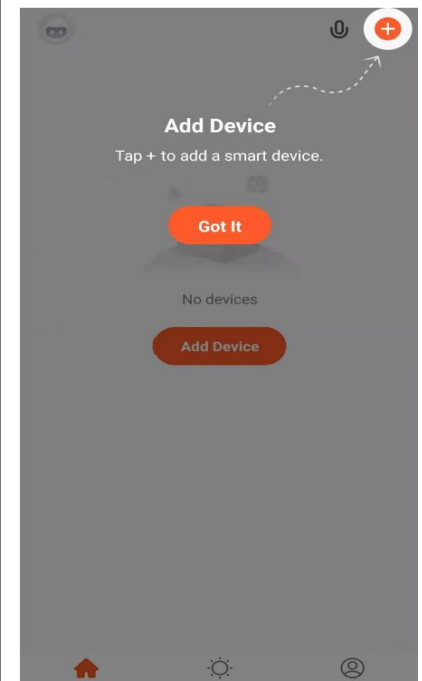

CONNECTING USING EZ (QUICK CONNECTION) MODE

Before initiating the connection, make sure the unit is in standby mode and that the WiFi light is flashing twice per second. If not, follow the instructions for changing the connection mode. Also, ensure your phone is connected to the WiFi network. (We advise turning mobile data off during

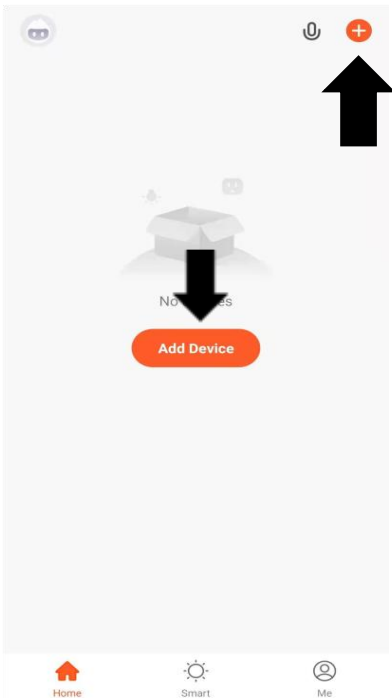
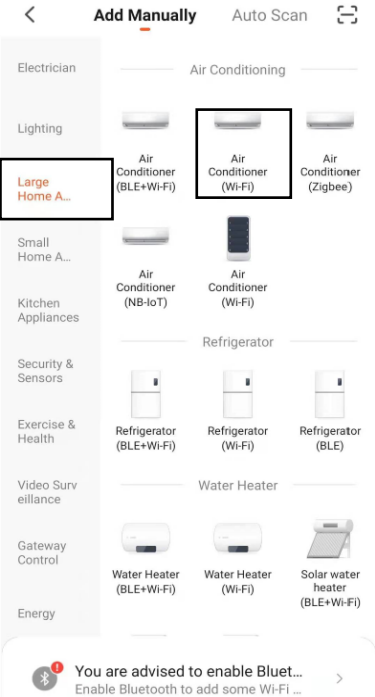
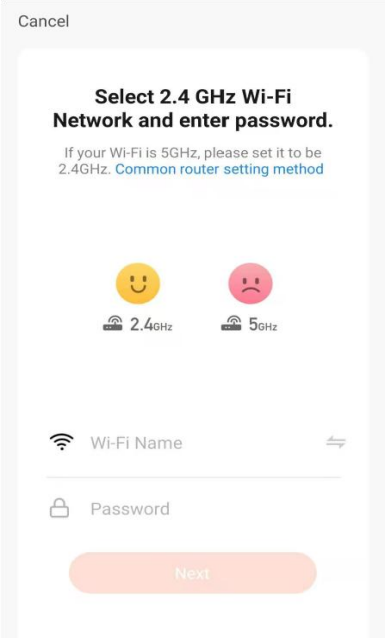
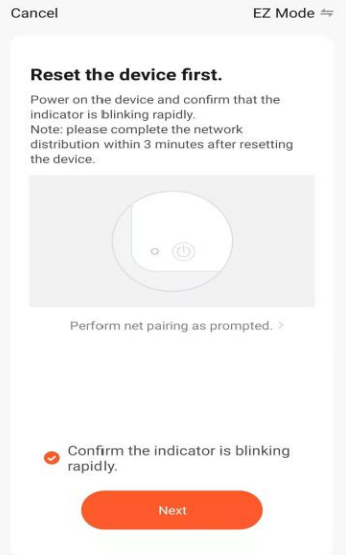
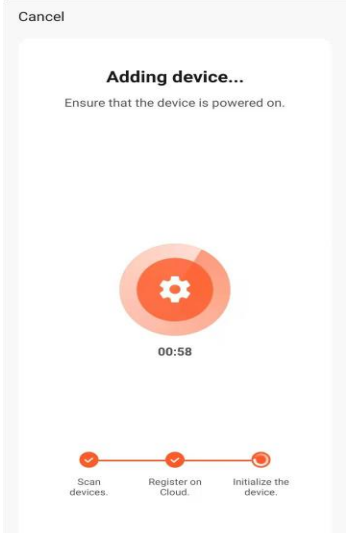
<p>1. Open the app and press “+” to add device</p> 	<p>2. Select the type of device as “Air Conditioner (WiFi)” within the Large Home Appliance tab.</p> 	<p>3. Select your network, enter your WiFi password and press Next.</p> 
<p>4. Ensure the WiFi light on the air conditioner is flashing twice per second then press on the orange button at the bottom of the screen to confirm</p> 	<p>5. This will then transfer the settings to the air conditioner. Wait for this to complete. If this fails, retry. If still unsuccessful please review the troubleshooting section for further help.</p> 	<p>setup)</p>



CONNECTING USING AP MODE (ALTERNATIVE METHOD)

Before initiating the connection, make sure the unit is in standby mode and that the WiFi light is flashing once per second. If not, follow the instructions to change the WiFi connection mode.

1. Open the app and press “+” to add device

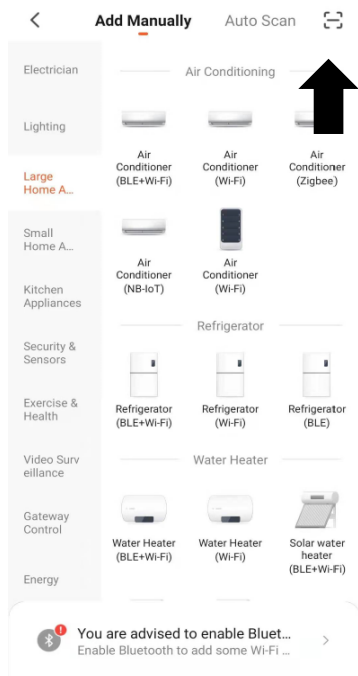

2. Select the type of device as “Air Conditioner (WiFi)” within the Large Home Appliance tab.

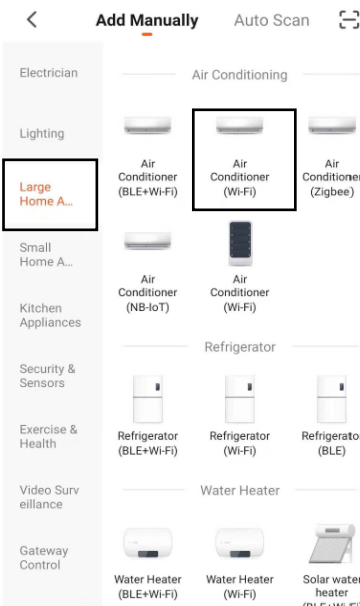

3. Select your network, enter your WiFi password and press Next.

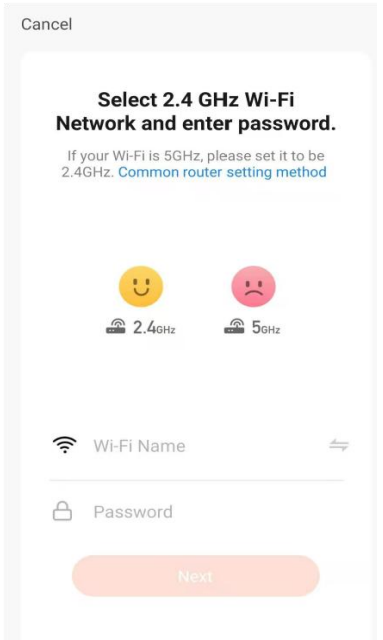

4. Ensure the WiFi light on the air conditioner is slowly flashing (once per three seconds), then select AP Mode in the top right corner before pressing on the orange button at the bottom of the screen to confirm

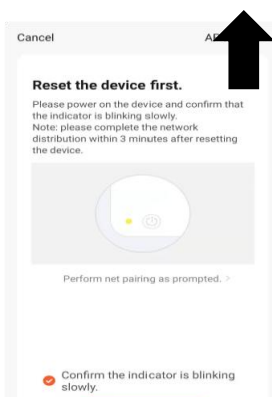

5. Go to network settings in your phone and connect to the “SmartLife xxx” connection. then press on the orange button at the bottom of the screen to confirm

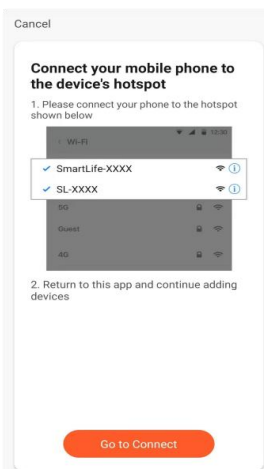

6. Go to network settings in your phone and connect to the “SmartLife xxx” connection. There is no password to enter. Then return back to the app to complete setup.

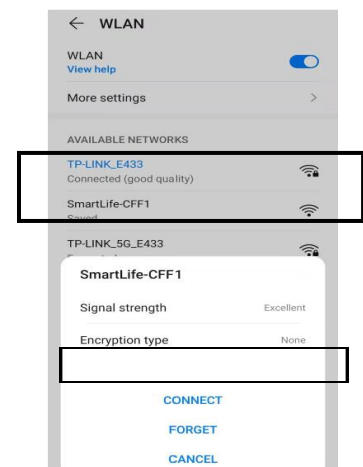

This will then transfer the settings to the air conditioner. Once the connection process has completed, go back to the network settings on your phone to ensure your phone has reconnected to your WiFi router.

Ensure your phone is connected to the WiFi network. (We advise turning mobile data off during setup)

CONTROLLING YOUR DEVICE THROUGH THE APP

THE HOME SCREEN

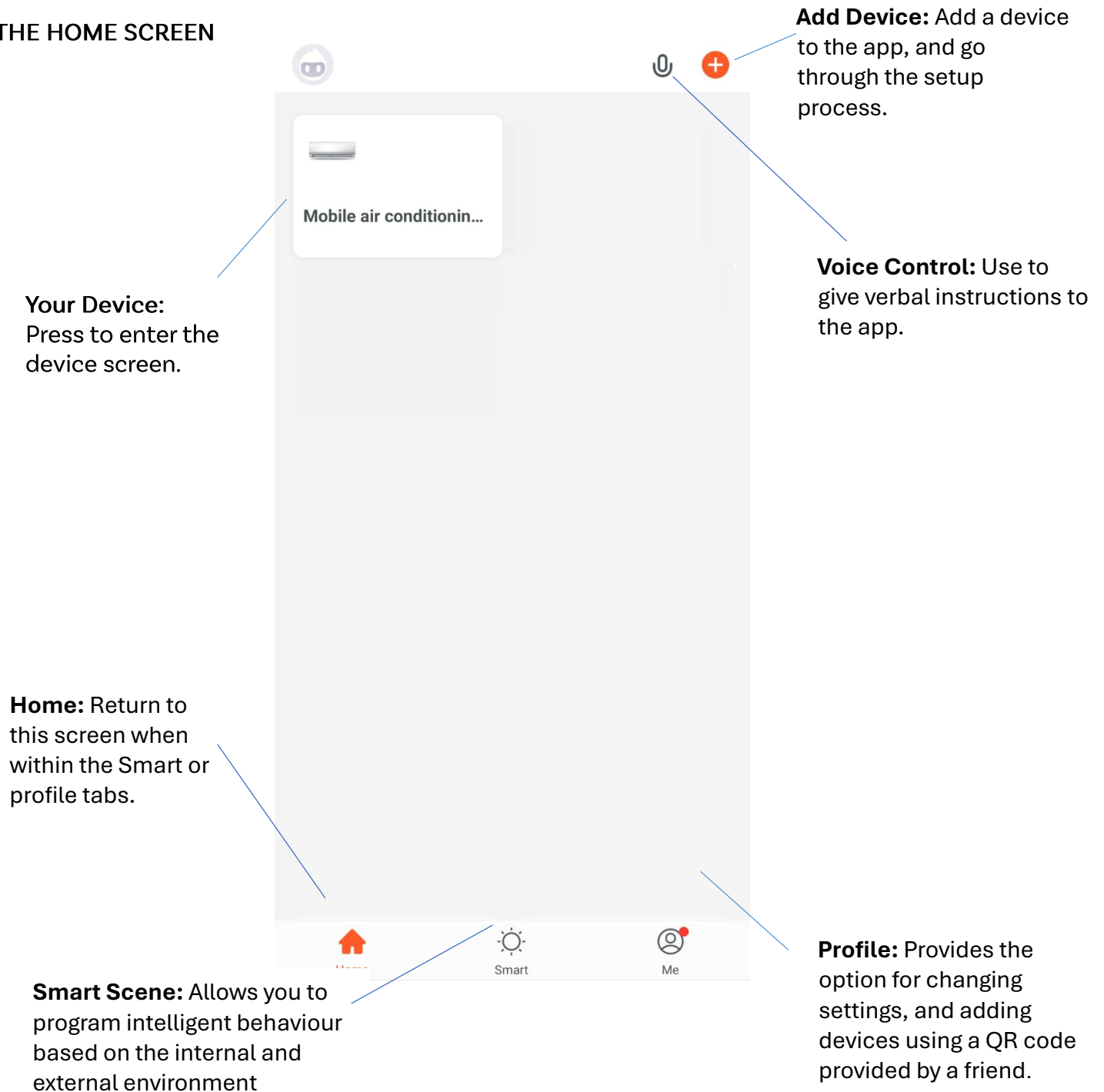

Each device has its own entry on the home screen, allowing the user to quickly turn the unit on or off or enter the device screen to make other changes.

DEVICE SCREEN

The device screen is the main control screen for the air conditioner, providing access to the controls for adjusting functions and settings.



Back: Returns to the Home Screen

Desired Temperature: Shows what temperature the unit is currently set to and a slider to set it.

Current Room Temperature: Displays the current room temperature.

POWER: Use to turn the air conditioner on and off.

MODE: (Will show as current mode)
Change the operating mode of the air conditioner between Cool, Auto, Dry, and Fan.

Sleep: To turn sleep on and off.

Temperature Unit Change:
To change from C° to F°

SWING: To turn the swing on and off.

SPEED: (Will show as current speed)
Use to change the Fan speed between F1 (Low) and F5 (High)

Edit Name: Use to change the name of the air conditioner.

The screenshot shows a mobile app interface for a 'Portable Air Conditioner p15cw'. At the top, there is a title bar with a back arrow on the left and an edit icon on the right. Below the title bar is a large circular temperature control dial showing '16°C' and 'Temp Set'. Underneath the dial, there are two status indicators: 'Current Temp -20°C' and 'Work State Auto'. Below these are three circular buttons: 'Switch' (power icon), 'Auto' (fan icon), and another 'Auto' button (fan icon). At the bottom, there are three toggle switches: 'Sleep', 'Swing', and 'Temp Unit Convert' (with a '°C >' indicator).

Due to ongoing app development, the layout and available features may change.

CREATING ROOMS

1. ON THE HOME SCREEN
Press on Home Management button

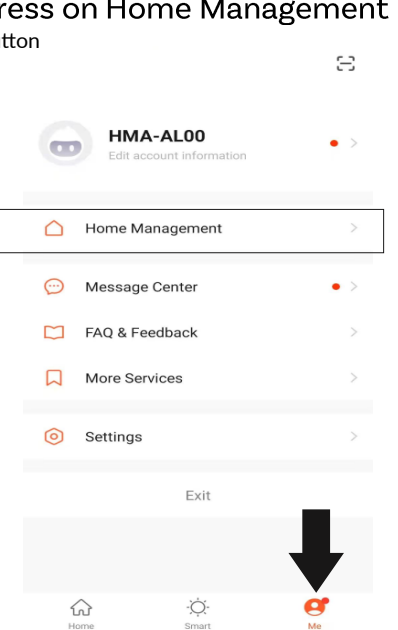

2. Type in a name for your home,
3. Press on the location button to select the location of your home. (See **SETTING YOUR LOCATION** below)
4. New rooms can be added by pressing the **ADD ANOTHER ROOM** option at the bottom. (See **ADD ANOTHER ROOM** below)
5. Untick any rooms that are not required on the app.
6. Press **DONE** in the top right corner

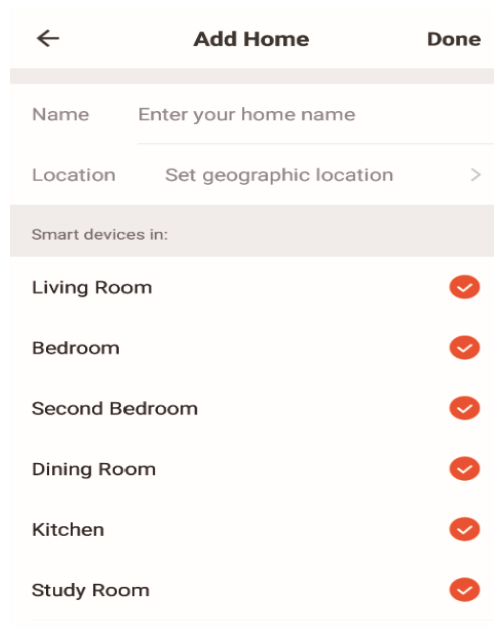

SETTING YOUR LOCATION

Use your finger to move the orange HOME symbol.

When the symbol is in the approximate location of your home, press the confirm button in the top right corner.

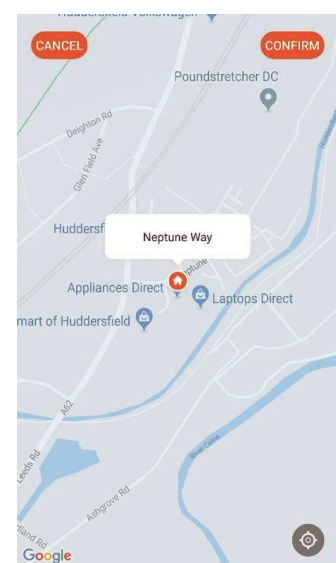

ADD ANOTHER ROOM

Type in the name of the room, and press Done in the top right corner

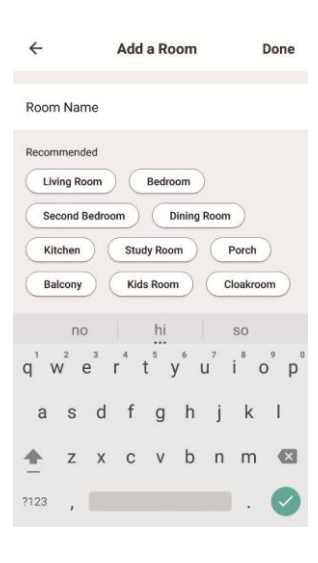



SMART SCENES

Smart Scenes is a powerful tool that lets you customise the air conditioner's operation based on conditions in the room and external factors. This gives the user the option of specifying much more intelligent actions. These are split into two categories: Scene and Automation.

SCENE

Scene allows a one-touch button to be added to the Home screen. The button can be used to change multiple settings in one go and adjust all settings within the unit. A number of scenes can be set up, allowing the user to switch between preset configurations.

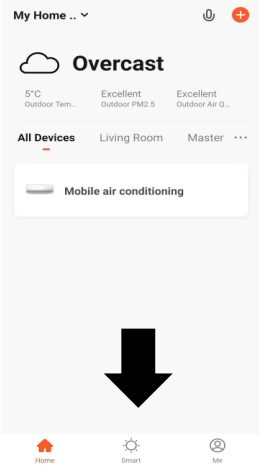
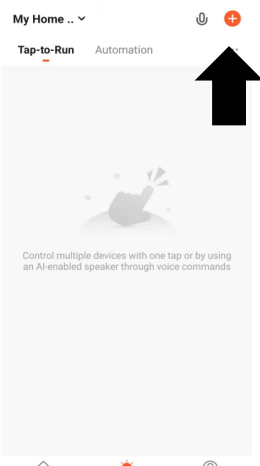
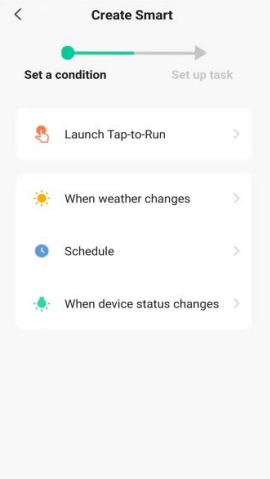
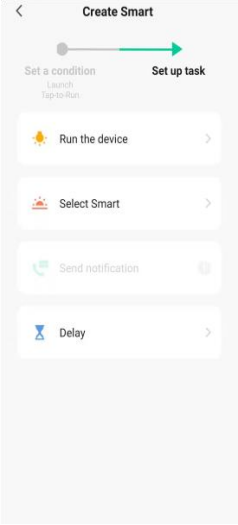
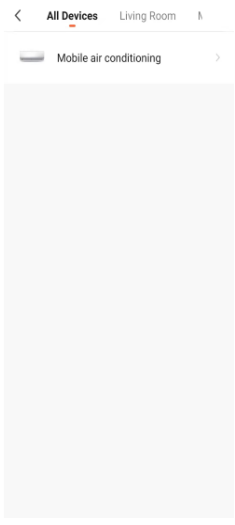
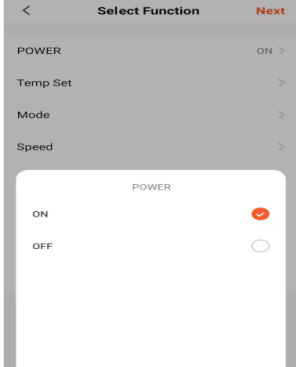
Below is an example of how to set up a scene:

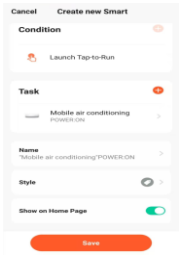
<p>1. Press on the Smart Scene tab at the bottom of the Home screen</p> 	<p>2. Press on the Plus in the top right corner to add a smart scene.</p> 	<p>3. Select the type of Scene to create.</p> 
	<p>4. Select Tap To Run, followed by the device you want to control.</p> 	<p>5. Choose the function, set the value for the function, and then press the back button in the top right corner, to return to the previous screen.</p> 
<p>6. Once all the functions required have been added, press the Next button in the top right corner to finalise and save your new Scene</p>		<p>7. Once you have named your scene, save it, and the button will be available to activate the scene with one touch within the app.</p> 

AUTOMATION

Automation allows an automatic action to be set up for the device. Time, indoor temperature and humidity, weather conditions, and other factors can trigger this.

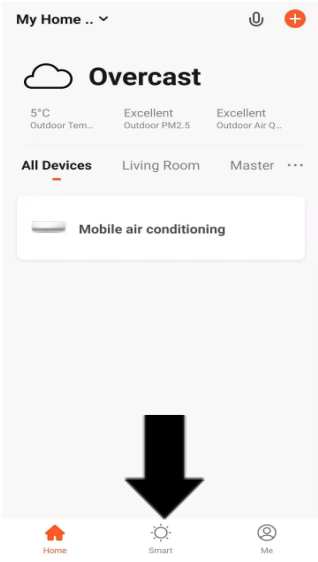
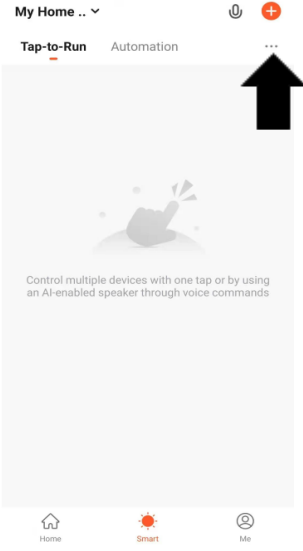
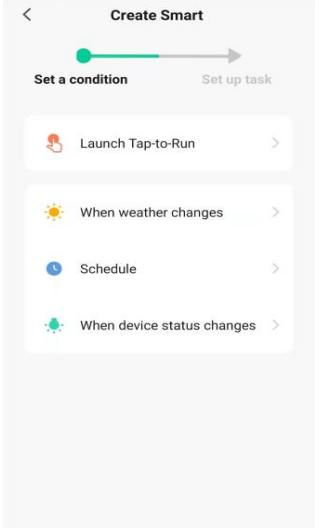
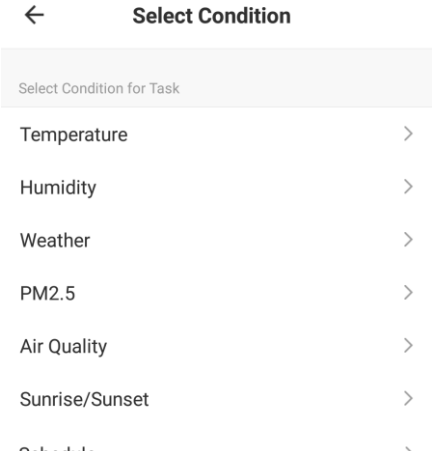
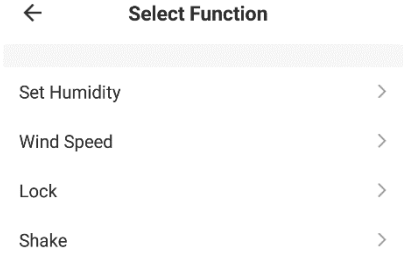
<p>1. Press on the Smart Scene tab at the bottom of the Home screen</p> 	<p>2. Press on the Plus in the top right corner to add a smart scene.</p> 	<p>3. Select the type of automation required, such as on schedule for setting up a timed operation.</p> 
<p>4. Select the condition when the automation should start. A number of triggers can be combined.</p> 	<p>5. Chose the function, set the value for the function, and then press the back button in the top right corner, to return to the previous screen.</p> 	
<p>6. Once all the functions required have been added, press the Save button to finalise and save your automated action. The automation can be turned on and off as required.</p>		

PROFILE TAB

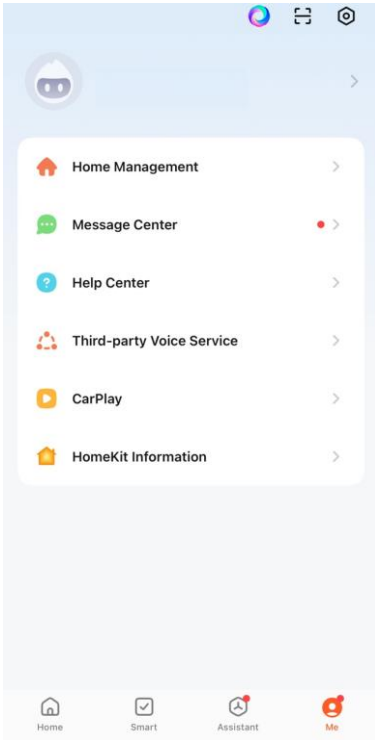

The profile tab lets you edit your details and use the unit's added features.

CHANGING THE NAME OF YOUR DEVICE

On any device screen, additional device settings can be accessed by pressing the three dots in the top-right corner. The top option in this allows you to change the device name to something relevant to the product's use, such as "Living Room Air Conditioner". In the menu, you can also set up a pattern lock or change your password.

MESSAGE CENTRE

Shows alerts generated by the App.

THIRD PARTY VOICE SERVICE

This allows the unit to be integrated with your favourite home automation hardware, such as Google Home and the Amazon Echo.

CONNECTION TROUBLESHOOTING

1. Check whether the device is powered on and is in the correct WiFi connection mode. If not, please refer to the CHANGING BETWEEN CONNECTION MODES section on page 12.
2. Ensure the WiFi password has been entered into the app correctly (Case sensitive)
3. Check that the phone is connected to the WIFI you are connecting the device to.
4. Ensure the network you are connecting to is 2.4Ghz (5Ghz WiFi networks are not supported), and that there is a strong WiFi signal to the item.
5. If your router is dual-band, ensure that the 2.4ghz network has a different network name (SSID). Further advice on changing router settings will be available from your Internet service provider / Router manufacturer.
6. Check the settings on the router. Encryption should be WPA2-PSK, and the authorisation type should be set to AES
7. Try using the alternative connection method. i.e., If the connection fails when attempting to connect via EZ mode, try AP mode.

CLEANING AND MAINTENANCE

PLEASE SHUT OFF THE UNIT AND UNPLUG FROM THE MAINS BEFORE CLEANING OR PERFORMING ANY MAINTENANCE

CLEAN THE SURFACE

Clean the machine's surface with a wet, soft cloth. Do not use chemicals such as benzene, alcohol, or gasoline, as acidic, corrosive, or alkaline substances may cause damage to the surface and/or the internal workings of the machine.

AIR FILTER CLEANING

If the filter screen is clogged with dust, the air conditioner's effectiveness is reduced. The filter screen should be cleaned every 2 weeks or as often as needed in your environment.

CLEAN THE TWO FILTER SCREEN FRAMES

Remove the filter screens by gently pulling the base outwards to unclip them from the appliance. Once removed, put the evaporator filter screen into warm water with neutral detergent (about 40 °C /104°F) and dry it in the shade after rinsing it clean.

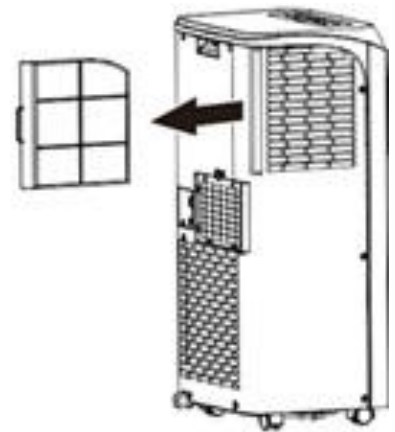

EMPTYING THE INTERNAL WATER TANK

When the internal water tank is full, the unit will stop working and display the HL error. There are 2 options for draining the internal water tank:

1) MANUAL DRAINAGE:

The unit should be manually drained before any prolonged storage, and the END-OF-SEASON MAINTENANCE instructions should be followed.

Turn off the unit and unplug. Avoid abrupt movements of the appliance, as this may cause water in the internal tank to spill out.

Place a tray in a drainage area under the drain port. Remove the cap from the drain port - water will drain from the internal tank. Once the tank is empty, replace the cap.

2) CONTINUOUS DRAINAGE:

Remove the cap from the drain port. Connect a drainage pipe (14mm internal diameter) to the drain port. You can plumb this pipe into your current plumbing system, lead it outside, use gravity fall, or use an external water pump.

END-OF-SEASON MAINTENANCE

1. Remove the rubber stoppers from the drainage holes and empty the internal tank. You can also drain the water by leaning the unit backwards.
2. Run the unit in fan mode, with a low fan speed, with the rubber stopper still removed and a container under the lower drain port.
3. Keep the unit in this mode for half a day - until the conduit is dry. Doing this helps to keep the inside of the unit dry and prevents mould from developing.
4. Turn off the unit and disconnect the plug.
5. Replace the rubber stopper.
6. Coil the cable, bind it together, and put it into the cable storage compartment.
7. Separate the vent pipe and store it safely.
8. Cover the unit and keep it in a dry place.
9. Take the batteries out of the remote control and store or dispose of them safely.
10. Keep all accessories with the unit ready for next season.

TECHNICAL SPECIFICATION

Model	P15CW
Cooling capacity:	14,000 BTU
Rated Input:	1500W
Rated Current:	6.6A
Fan:	3 speeds
Airflow:	420m ³ /h
EER Rate:	2.6 / A
Refrigerant:	R290/305g
Sound Power Level:	65dB
Sound Pressure Level*:	52-53 dB(A)
Thermostat:	16-31°C
Maximum Allowable Pressure of suction/ exhaust side:	1.2/2.3MPa
Maximum Allowable Pressure	4.2MPa
Power Supply:	AC 220-240V/50 Hz
Net Weight:	30.9 kg
Dimension(L*D*H):	358*419*688 mm
<p>* Measured at a distance of 1m in accordance with EN ISO 11201:2010</p> <p>Sound power provides a consistent measure of an appliance's acoustic output, allowing easy comparison between appliances. In contrast, Sound pressure provides a measure of the intensity of sound perceived by people in the vicinity of the appliance, making it the ideal metric for assessing an appliance's impact on noise in an area.</p> <p>The unit must be vented outside when in air-cooling mode. For the purposes of EU regulation EN12102, this is a local air conditioner that produces less than 65dB(A) sound energy.</p>	
 <p>R 290</p>	

PRODUCT FICHE

Description	Symbol	Value	Unit
Rated capacity for cooling	P_{rated} for cooling	4.0	kW
Rated capacity for heating	P_{rated} for heating	-	kW
Rated power input for cooling	P_{EER}	1.57	kW
Rated power input for heating	P_{COP}	-	kW
Rated Energy efficiency ratio	$EERd$	2.6	—
Rated Coefficient of performance	$COPd$	-	—
Power consumption in thermostat-off mode	P_{TO}	120	W
Power consumption in standby mode	P_{SB}	1.4	W
Electricity consumption of single/double duct appliances (indicate for cooling and heating separately)	$DD: Q_{DD}$	-	DD: kWh/a
	$SD: Q_{SD}$	1.1	SD: kWh/h
Sound power level	L_{WA}	65	dB(A)
Global warming potential	GWP	3	kgCO ₂ eq.

ERROR CODES

CODE	PROBLEM	SOLUTION
E1 or E2	Internal temperature outside normal range.	Leave unplugged for 30 minutes. If this does not resolve, contact customer services.
HL	Water tank full	Empty the internal tank.

TROUBLESHOOTING

Do not repair or disassemble the air conditioner. Unqualified repair will invalidate the warranty and may lead to failure, causing injuries and property damage. Only use it as directed in this user manual and only perform operations advised here.

Problems	Reasons	Solutions
The air conditioner does not work.	There is no electricity.	Please turn it on after connecting it to a power outlet.
	The display shows "HL".	Discharge the water inside.
	The ambient temperature is too low or too high.	Only use the machine within a temperature range of 10-35 °C (50-95°F).
	In cooling mode, the room temperature is lower than the desired temperature.	Change the desired temperature.
	In dry mode, the ambient temperature is low.	The ambient temperature must be above 17 °c. (62 °F).
The unit only works for a short time.	Bends or blockage in the exhaust hose	Correct the venting as per the instructions in this manual.
The cooling effect is not good.	There is direct sunlight.	Use curtains to reduce the direct sunlight.
	Doors or windows are open; there are a lot of people; or in cooling mode, there are other sources of heat (e.g. fridges)	Close doors and windows; increase air conditioning power
	The filter screen is dirty.	Clean or replace the filter screen.
	The air inlet or outlet is blocked.	Clear obstructions: make sure venting is correct as described in this user manual, and the hose is not bent
	The exhaust hose is not attached to the unit.	Attach the hose and vent the unit correctly.
Loud Noise	The air conditioner is not placed on a flat surface.	Put the air conditioner on a flat, hard surface (to reduce noise).
Unpleasant Odour	There is an unpleasant odour in the room	Clean the filters and ensure the unit's interior is clean.
The compressor does not work.	Overheat protection starts.	Wait 3 minutes for the temperature to drop, then restart the machine.
The remote control does not work.	The distance between the machine and the remote control is too far.	Bring the remote control close to the air conditioner and ensure it faces the receiver directly.
	The remote control is not aligned with the receiver.	
	Batteries are dead.	Replace batteries.
Others	No refrigerant or there is minimal refrigerant.	Refer to the Service Centre (check leakage, welding, vacuum pump, charge refrigerant according to nameplate)
	Anti-freezing protection	Waiting for defrosting. The function will recover automatically. No user input is needed.
	High-pressure protection.	Once the internal gas pressure drops, it will function normally. No user input is needed.

If problems not listed in the table occur or recommended solutions do not work, please get in touch with the service centre.

1. Has the unit been standing upright for at least 2 hours?
2. Is the unit plugged into the mains?
3. Is the fuse OK?
4. Switch the unit off and wait three minutes to see if the issue is resolved. Restart the unit.
5. Check if the water tank is full.



Disposal: Do not dispose this product as unsorted municipal waste. Collection of such waste must be handled separately, as it requires special treatment. Recycling facilities are now available to all customers, where you can deposit your old electrical products. Customers will be able to take any old electrical equipment to participating civic amenity sites run by their local councils. Please remember that this equipment will be further handled during the recycling process, so please be considerate when depositing your equipment. Please get in touch with the local council for details of your local household waste recycling centres.

PSTI STATEMENT OF COMPLIANCE

Description: Air Conditioner

Model Number: P15CW

Manufacturer: electriQ, 2A Trident Business Park, Leeds Road, Huddersfield, HD2 1UA

PSTI Contact: TiSecurity@buyitdirect.co.uk

We have prepared this statement of compliance and can confirm that this product is compliant with the deemed compliance conditions in Schedule 2 of The Product Security and Telecommunications Infrastructure (Security Requirements for Relevant Connectable Products) Regulations 2023.

Duration of security updates: 31/12/2030. This date is correct at the time of printing, but we may be extended. Please visit www.electriQ.co.uk for the latest information and details of our PSTI compliance.

Richard Leach

Compliance and Quality Manager, Buy It Direct,
Huddersfield

19th December 2025

EU DECLARATION OF CONFORMITY

Hereby, electriQ declares that these air conditioners are in compliance with Directive 2014/53/EU. The full text of the EU declaration of conformity is available at the following internet addresses:

<https://www.electriq.co.uk/files/DOC/EU/P15CW.pdf>

UK DECLARATION OF CONFORMITY

Hereby, electriQ declares that these air conditioners are in compliance with Radio Equipment Regulations 2017. The full text of the UK declaration of conformity is available at the following internet addresses:

<https://www.electriq.co.uk/files/DOC/UK/P15CW.pdf>

electriQ UK SUPPORT

www.electriQ.co.uk/support

Please consult the troubleshooting section before calling the service line. Call the number below if the unit fails to operate or complete the online form.

0330 390 3061

Office hours: 9 AM - 5 PM, Monday to Friday

www.electriQ.co.uk

Unit 2A, Trident Business Park,
Neptune Way, Leeds Road, Huddersfield, HD2 1UA.

electriQ

V20260317RLJ