



# ELECTRIC BUILT-IN OVEN

Use & Care Guide

# HORNO DE PARED

Manual del Usuario

Model, Modelo 790.41003

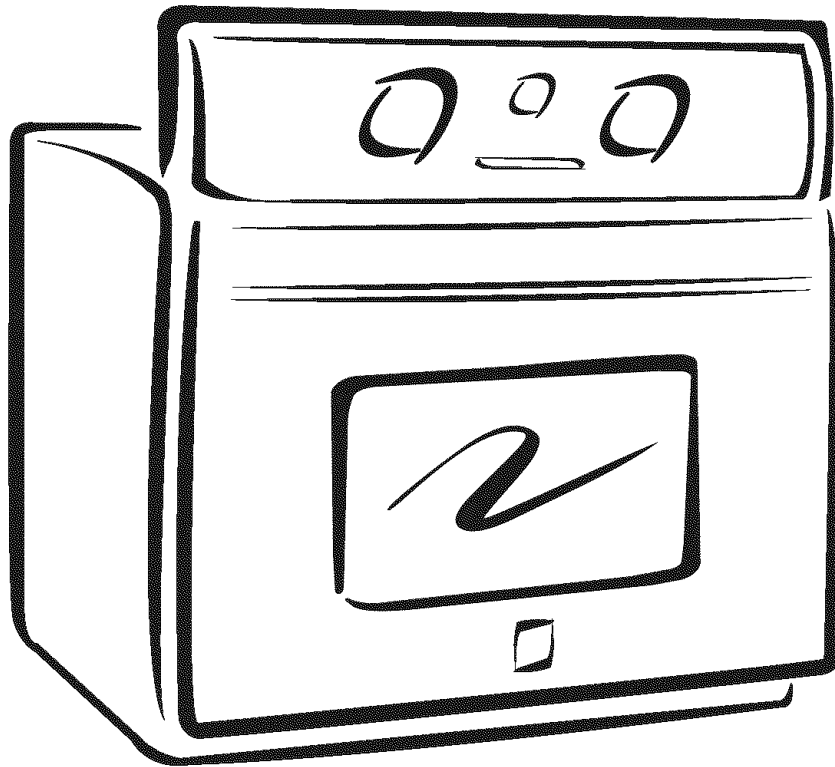

ENGLISH

ESPAÑOL

---

# Table of Contents

Wall Oven Warranty .....	2	Setting the Oven Controls .....	9-13
<b>IMPORTANT SAFETY INSTRUCTIONS</b> .....	<b>3-4</b>	<b>Self-Cleaning</b> .....	<b>14-15</b>
Product Record .....	4	<b>Adjusting the Oven Temperature</b> .....	<b>15</b>
Serial Plate Location .....	4	<b>General Care &amp; Cleaning</b> .....	<b>16</b>
Protection Agreements .....	5	Cleaning Various Parts of Your Oven .....	16
Wall Oven Features .....	6	Care and Cleaning of Stainless Steel .....	17
Oven Vent and Racks .....	7	To Remove and Replace Oven Door .....	17
Air Circulation in the Oven .....	7	Special Door Care Instructions .....	17
Oven Ladder Racks Positions .....	7	Changing the oven light .....	17
Control Pad Features .....	8	<b>Before You Call</b> .....	<b>18-19</b>
Setting the Clock .....	8-9	<b>Sears Service</b> .....	<b>22</b>
Consumer Defined Control Features .....	9	<b>Español</b> .....	<b>23</b>

---

## Kenmore Pro Appliance Warranty

### One Year Limited Warranty

When installed, operated and maintained according to all instructions supplied with the product, if this appliance fails due to a defect in material or workmanship within one year from the date of purchase, call 1-800-4-MY-HOME® to arrange for free repair. If this appliance is used for other than private family purposes, this warranty applies for only 90 days from the date of purchase.

#### **This warranty covers only defects in material and workmanship. Sears will NOT pay for:**

1. Expendable items that can wear out from normal use, including but not limited to filters, belts, light bulbs, and bags.
2. A service technician to instruct the user in correct product installation, operation or maintenance.
3. A service technician to clean or maintain this product.
4. Damage to or failure of this product if it is not installed, operated or maintained according to all instructions supplied with the product.
5. Damage to or failure of this product resulting from accident, abuse, misuse or use for other than its intended purpose.
6. Damage to or failure of this product caused by the use of detergents, cleaners, chemicals or utensils other than those recommended in all instructions supplied with the product.
7. Damage to or failure of parts or systems resulting from unauthorized modifications made to this product.

#### **Disclaimer of implied warranties; limitation of remedies**

Customer's sole and exclusive remedy under this limited warranty shall be product repair as provided herein. Implied warranties, including warranties of merchantability or fitness for a particular purpose, are limited to one year or the shortest period allowed by law. Sears shall not be liable for incidental or consequential damages. Some states and provinces do not allow the exclusion or limitation of incidental or consequential damages, or limitations on the duration of implied warranties of merchantability or fitness, so these exclusions or limitation may not apply to you.

This warranty applies only while this appliance is used in the United States and Canada.

This warranty gives you specific legal rights, and you may also have other rights which vary from state to state.

**Sears, Roebuck and Co., Hoffman Estates, IL 60179**  
**Sears Canada Inc., Toronto, Ontario, Canada M5B 2B8**

# Important Safety Instructions

Read all instructions before using this appliance.

Save these instructions for future reference.

This manual contains important safety symbols and instructions. Please pay attention to these symbols and follow all instructions given.

**⚠ WARNING** This symbol will help alert you to situations that may cause serious bodily harm, death or property damage.

**⚠ CAUTION** This symbol will help alert you to situations that may cause bodily injury or property damage.

- **Remove all tape and packaging before using the appliance.** Destroy the carton and plastic bags after unpacking the appliance. Never allow children to play with packaging material.
- **Proper Installation. Be sure your appliance is properly installed and grounded by a qualified technician in accordance with National Electrical Code ANSI/NFPA No.70 (USA) or CSA C22.1, PART 1 (Canada)-latest edition and local code requirements.** Install only per installation instructions provided in the literature package for this appliance.

**⚠ CAUTION** Electronic controllers can be damaged by cold temperatures. When you use your appliance for the first time, or if it has not been used for a long period of time, make sure that it has been exposed to a temperature above 0°C/32°F for at least 3 hours before connecting it to the power supply.

- In case of an emergency, know how to disconnect the electrical power to the appliance at the circuit breaker or fuse box.
- **User Servicing—Do not repair or replace any part of the appliance unless specifically recommended in the manuals.** All other servicing should be done only by a qualified technician to reduce the risk of personal injury and damage to the cooktop. Sears Parts & Repair is the recommended repair service for this appliance.
- **Never modify or alter the construction of an appliance by removing panels, wire covers or any other part of the product.**
- Remove the oven door from any unused appliance if it is to be stored or discarded.

**⚠ WARNING** Stepping, leaning, sitting or pulling down on the door of this appliance can result in serious injuries and may also cause damage to the appliance. Do not allow children to climb or play around the appliance.

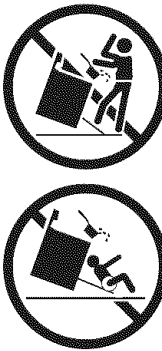

**⚠ WARNING**

- All wall ovens can tip.
- Injury to persons could result.
- Install anti-tip bracket packed with wall oven.
- See Installation Instructions.

To reduce the risk of tipping, the wall oven must be secured by properly installed anti-tip bracket provided with the wall oven. Refer to the Installation Instructions for proper anti-tip bracket installation.

- **Storage on Appliance. Flammable materials should not be stored near surface units.** This includes paper, plastic and cloth items, such as cookbooks, plasticware and towels, as well as flammable liquids. Do not store explosives, such as aerosol cans, on or near the appliance. Flammable materials may explode and result in fire or property damage.

**⚠ WARNING** Do not use the oven for storage.

**⚠ CAUTION** Do not store items of interest to children in the cabinets above an appliance. Children climbing on the appliance to reach items could be seriously injured.

- **Do not leave children alone. Children should not be left alone or unattended in the area where an appliance is in use.** They should never be allowed to sit or stand on any part of the appliance.
- **DO NOT TOUCH BAKE AND BROILING ELEMENTS OR AREAS NEAR THESE ELEMENTS.** Baking and broiling elements may be hot even though they are dark in color. Areas near elements may become hot enough to cause burns. During and after use, do not touch, or let clothing or other flammable materials touch these areas until they have had sufficient time to cool.
- **Wear Proper Apparel. Loose-fitting or hanging garments should never be worn while using the appliance.** Do not let clothing or other flammable materials contact hot surfaces.

**⚠ WARNING** Never use your appliance for warming or heating the room.

- **Do Not Use Water or Flour on Grease Fires.** Smother the fire with a pan lid, or use baking soda, a dry chemical or foam-type extinguisher.
- **When heating fat or grease, watch it closely.** Fat or grease may catch fire if allowed to become too hot.
- **Use Only Dry Potholders. Moist or damp potholders on hot surfaces may result in burns from steam.** Do not let the potholders touch hot heating elements. Do not use a towel or other bulky cloth instead of a potholder.
- **Do Not Heat Unopened Food Containers. Buildup of pressure may cause the container to burst and result in injury.**

**IMPORTANT—Do not attempt to operate the appliance during a power failure.** If power fails, always turn off the appliance. If the appliance is not turned off and the power resumes, it will begin to operate again. Once the power resumes, reset the clock and oven function.

# Important Safety Instructions

## IMPORTANT INSTRUCTIONS FOR USING YOUR OVEN

- **Use Care When Opening an Oven Door**—Stand to the side of the appliance when opening the door of a hot oven. Let hot air or steam escape before you remove or replace food in the oven.
- **Keep Oven Vent Ducts Unobstructed.** The wall oven is vented through the center trim of the oven. Touching the surfaces in this area when the wall oven is operating may cause severe burns. Also, do not place plastic or heat-sensitive items near the oven vent. These items could melt or ignite.
- **Placement of Oven Racks.** Always place oven racks in desired location while oven is cool. Remove all utensils from the rack before removing rack. If rack must be moved while oven is hot, use extreme caution. Use pot holders and grasp the rack with both hands to reposition. Do not let pot holders contact the hot oven element or interior of the oven.
- **Do not use the broiler pan without its insert.** The broiler pan and grid allow dripping fat to drain and be kept away from the high heat of the broiler.
- **Do not cover the broiler grid or oven bottom with aluminum foil.** Exposed fat and grease could ignite.
- **Do not touch a hot oven light bulb with a damp cloth.** Doing so could cause the bulb to break. Disconnect the appliance or shut off the power to the appliance before removing and replacing the bulb.
- **Protective liners**—Do not use aluminum foil to line the oven bottom. Only use aluminum foil as recommended in this manual. Improper installation of these liners may result in risk of electric shock, or fire.

## IMPORTANT INSTRUCTIONS FOR CLEANING YOUR OVEN

- **Clean the appliance regularly to keep all parts free of grease that could catch fire.** Exhaust fan ventilation hoods and grease filters should be kept clean. Do not allow grease to accumulate. Greasy deposits in the fan could catch fire. Refer to the hood manufacturer's instructions for cleaning.
- **Cleaners/Aerosols**—Always follow the manufacturer's recommended directions for use. Be aware that excess residue from cleaners and aerosols may ignite causing damage and/or injury.

## SELF CLEANING OVEN MODELS

- **Clean in the self-cleaning cycle only the parts of the appliance listed in this Owner's Guide.** Before using the self-cleaning cycle of the appliance, remove the broiler pan and any utensils stored in the appliance.
- **Do not clean the oven door gasket.** The door gasket is essential for a good seal. Care should be taken not to rub, damage or move the gasket.
- **Do not use oven cleaners.** No oven cleaner or oven liner protective coating of any kind should be used in or around any part of the appliance

**CAUTION** The health of some birds is extremely sensitive to the fumes given off during the self-clean cycle of any wall oven. Move birds to another well ventilated room.

## IMPORTANT SAFETY NOTICE

The California Safe Drinking Water and Toxic Enforcement Act requires the Governor of California to publish a list of substances known to the state to cause cancer, birth defects or other productive harm, and requires businesses to warn customers of potential exposure to such substances.

## Product Record

In this space below, record the date of purchase, model and serial number of your product. You will find the model and serial number printed on the serial plate.

Model No. **790.41003** \_\_\_\_\_

Serial No. \_\_\_\_\_

Date of purchase \_\_\_\_\_

Save these instructions and your sales receipt for future reference.

## Serial Plate Location

You will find the model and serial number printed on the serial plate. The serial plate is located along the interior side trim and visible when the oven door is opened.

Remember to record the serial number for future reference.

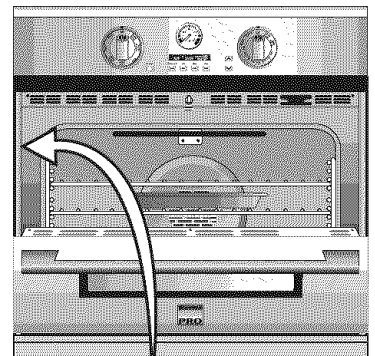

Serial Plate Location

Please carefully read and save these instructions

# PROTECTION AGREEMENTS

## In the U.S.A.

### Master Protection Agreements

Congratulations on making a smart purchase. Your new Kenmore® product is designed and manufactured for years of dependable operation. But like all products, it may require preventive maintenance or repair from time to time. That's when having a Master Protection Agreement can save you money and aggravation.

*Purchase a Master Protection Agreement now and protect yourself from unexpected hassle and expense.*

The Master Protection Agreement also helps extend the life of your new product. Here's what's included in the Agreement:

- ✓ **Expert service** by our 12,000 professional repair specialists
- ✓ **Unlimited service and no charge** for parts and labor on all covered repairs
- ✓ **“No-lemon” guarantee** – replacement of your covered product if four or more product failures occur within twelve months
- ✓ **Product replacement** if your covered product can't be fixed
- ✓ **Annual Preventive Maintenance Check** at your request – no extra charge
- ✓ **Fast help by phone** – phone support from a Sears representative on products requiring in-home repair, plus convenient repair scheduling
- ✓ **Power surge protection** against electrical damage due to power fluctuations
- ✓ **Rental reimbursement** if repair of your covered product takes longer than promised

Once you purchase the Agreement, a simple phone call is all that it takes for you to schedule service. You can call anytime day or night, or schedule a service appointment online.

Sears has over 12,000 professional repair specialists, who have access to over 4.5 million quality parts and accessories. That's the kind of professionalism you can count on to help prolong the life of your new purchase for years to come. Purchase your Master Protection Agreement today!

**Some limitations and exclusions apply.**  
**For prices and additional information call**  
**1-800-827-6655.**

### Sears Installation Service

For Sears professional installation of home appliances, garage door openers, water heaters, and other major home items, in the U.S.A. call **1-800-4-MY-HOME®**

## In Canada

### Maintenance Agreements

Your purchase has added value because you can depend on Sears HomeCentral® for service. With over 2400 Service Technicians and more than a million parts and accessories, we have the tools, parts, knowledge and skills to ensure our pledge: We Service What We Sell.

Your Kenmore® product is designed, manufactured and tested to provide years of dependable operation. But like all products, it may require service from time to time. The Sears Maintenance Agreement offers you an outstanding service program, affordably priced.

### The Sears Maintenance Agreement:

- Is your way to buy tomorrow's service at today's price
- Eliminates repair bills resulting from normal wear and tear
- Provides phone support from a Sears representative on products requiring in-home repair
- Even if you don't need repairs, provides an annual Preventive Maintenance Check, at your request, to ensure that your product is in proper running condition.

**Some limitations apply. For more information about Sears Canada Maintenance Agreements, call 1-800-361-6665**

ENGLISH

# Wall Oven Features

## Your Electric Wall Oven Features At a Glance

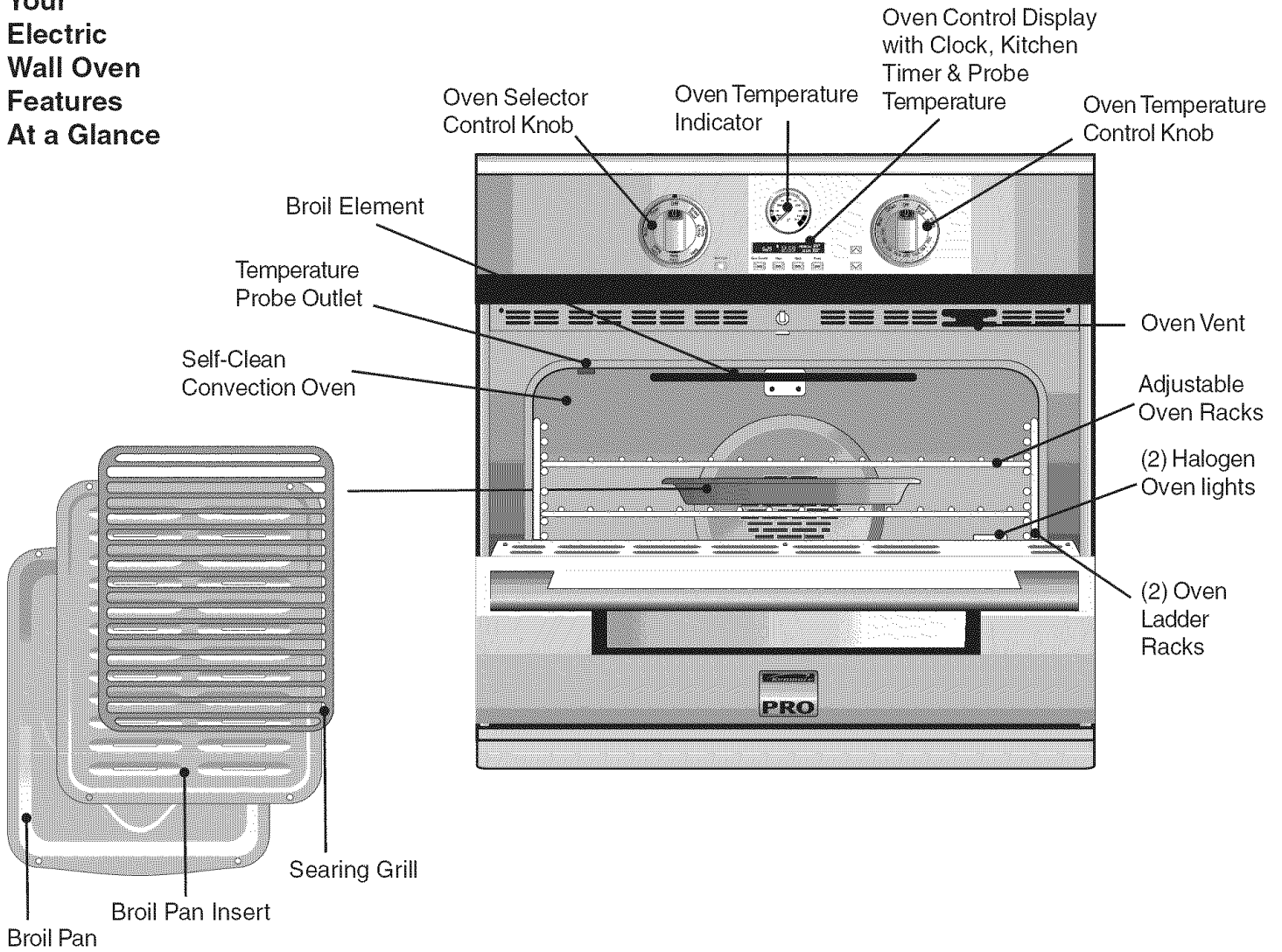

# Oven Vent and Racks

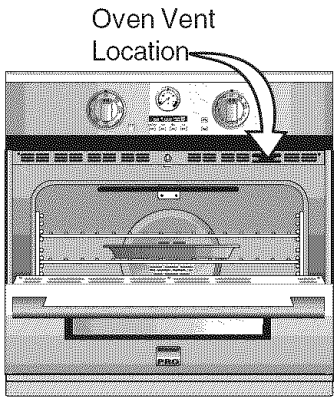

**CAUTION** This model is equipped with a blower which runs in baking and self-cleaning mode to keep all internal components at a cool temperature. The blower may keep running even if the oven has been turned off, until the components have cooled down.

## Oven Vent Location

The oven is vented **through the center trim of the oven**. When the oven is on, warm air is released through the vent. This venting is necessary for proper air circulation in the oven and good baking results.

## Arranging Oven Racks

*ALWAYS ARRANGE OVEN RACKS WHEN THE OVEN IS COOL (PRIOR TO OPERATING THE OVEN).* Always use oven mitts when the oven is in use.

**To remove an oven rack**, pull the rack forward.

**To replace an oven rack**, fit the rack onto the guides of the oven ladder racks. Tilt the front of the rack upward and slide the rack back into place.

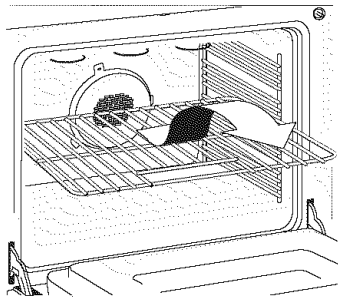

## Air Circulation in the Oven

If using 1 rack, place in center of oven. If using multiple racks, stagger cookware as shown.

For best air circulation and baking results allow 2-4" (5-10 cm) around the cookware for proper air circulation and be sure pans and cookware do not touch each other, the oven door, sides or back of the oven cavity. The hot air must circulate around the pans and cookware in the oven for even heat to reach around the food.

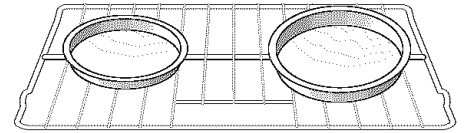

1 Oven Rack

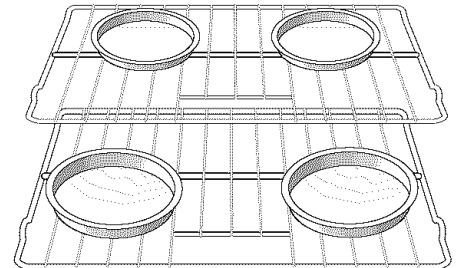

Multiple Oven Racks

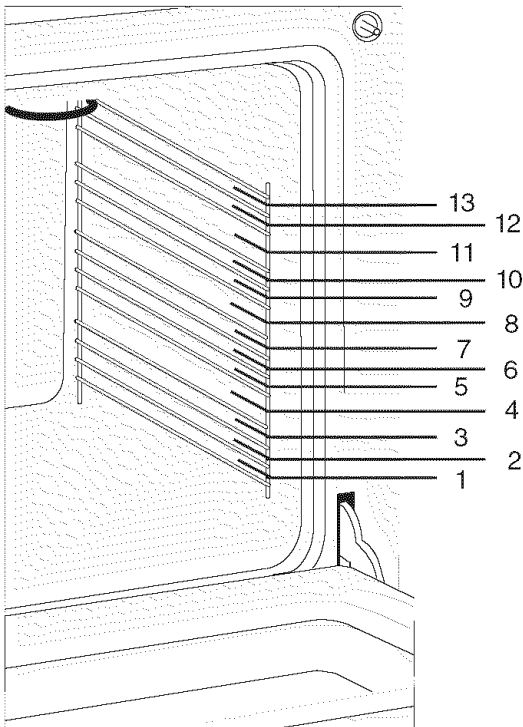

Ladder Rack Positions

## Oven Ladder Racks

This appliance is equipped with an oven ladder rack system which allows oven racks to be placed in multiple positions. This system also facilitates the removal of oven racks and will give you more precise control of the desired baking results.

*ONLY REMOVE LADDER RACKS WHEN THE OVEN IS COOL (PRIOR TO A SELF CLEAN OPERATION).* Always use oven mitts when the oven is in use.

**To remove an oven ladder rack**, pull the rack upward and remove it from the guides in the oven cavity.

**To replace an oven ladder rack**, fit the rack onto the guides of the oven cavity and push downward.

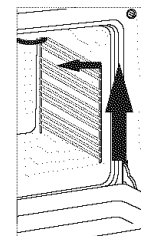

Ladder Rack Removal

Ladder Rack Replacement

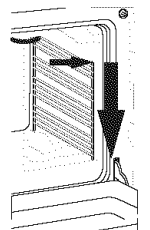

# Control Button Features

**READ THE INSTRUCTIONS CAREFULLY BEFORE USING THE OVEN.** For satisfactory use of your oven, become familiar with the various features and functions of the oven as described below. **Detailed instructions for each feature and function follow later in this Use & Care Guide.**

**SELECTOR CONTROL KNOB-** Use to select the Bread Proof, Warm & Hold, Bake, Convection Bake, Convection Roast, Broil or Clean Feature.

**OVEN TEMPERATURE CONTROL KNOB—** Use to select the Bread Proof, Warm & Hold, or the required Bake, Convection Bake, Convection Roast, Broil or Clean Temperature.

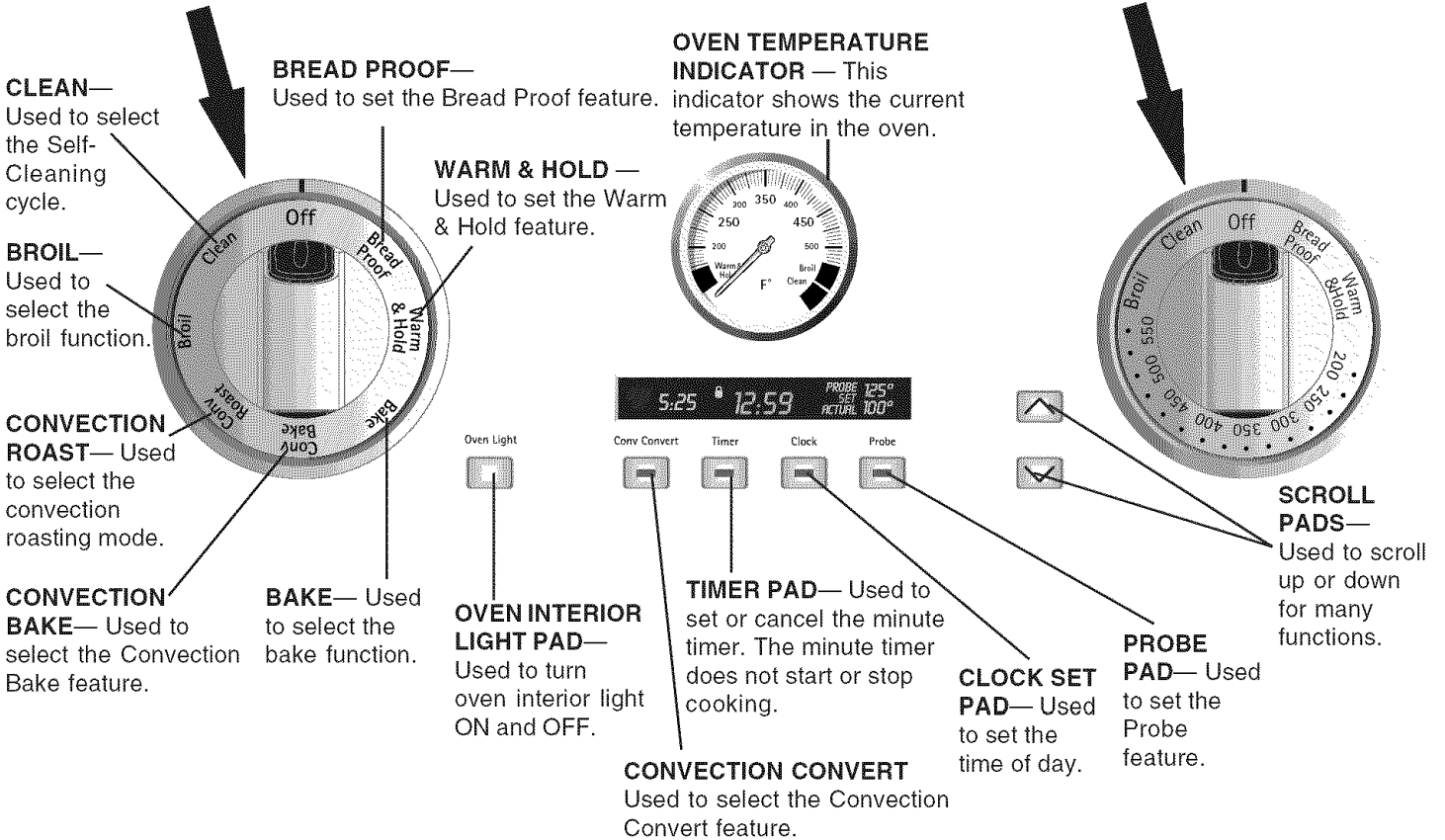





## Setting the Clock



The  button is used to set the clock. Until the clock is set, all the other oven functions will not be available. The clock may be set for 12 or 24 hour time of day operation. The clock has been preset at the factory for the 12 hour operation. When the range is first plugged in, or when the power supply to the appliance has been interrupted, the display will flash with "PF".

When **PF** flashes in the display, press the  button. No other button will stop the time from flashing.

### To set the clock

1. Press the  button. The control will beep once and the time of day will appear in the display.
2. To set the clock to the current time of day, press the  or  button to increase or decrease the time of day in 1 minute increments, or keep the  or  button pressed to increase or decrease the time of day in 10 minute increments.
3. Release the button when the desired time is reached. Wait 5 seconds and the change will be accepted.

### Changing between 12 or 24 hour time of day display



1. Press and hold the  button for 6 seconds. The display will show either "12" (for 12 hour clock) or "24" (for 24 hour clock).
2. Press the  or  button to switch between the 12 and 24 hour time of day display.
3. Wait 6 seconds to accept the change.

## Setting the Clock (cont'd)

### Setting Continuous Bake or 12 Hour Energy Saving

The oven control has a factory preset built-in 12 Hour Energy Saving feature that will shut off the oven if the oven control is left on for more than 11 hours and 59 minutes. The oven can be programmed to override this feature for Continuous Baking.







#### To set the control for Continuous Bake or 12 Hour Energy Saving features

1. Press and hold the  button for 6 seconds. The display will show either "12h" (for 12 hour maximum cooking time) or "--h" (for continuous cooking).
2. Press the  or  button to switch between the 12 hour and 24 hours continuous cooking mode.
3. Wait 6 seconds to accept the change.

### Setting the Timer

The Timer serves as an extra timer in the kitchen that will beep when the set time has run out. It can be set in 1 minute increments up to 11:59 (11 hours, 59 minutes). It does not start or stop cooking. The Kitchen Timer feature can be used during any of the other oven control functions, except the self-clean function.

#### To set the Kitchen Timer

1. Press the  button. The control will beep, the display will show "-- --" and the timer indicator light located on the button will start flashing.
2. To set the timer, press the  or  button to increase or decrease the time in 1 minute increments, or keep the  or  button pressed to increase or decrease the time in 10 minute increments.
3. When the set time has run out, "End" will show in the display. The control will sound with 3 beeps every 5 seconds until the  button is pressed.



#### To cancel the Kitchen Timer before the set time has run out

Press the  button. The display will return to the time of day.



### Setting Oven Lockout Feature

The Oven Lockout feature automatically locks the oven door and prevents the Oven from being turned on. It does not disable the clock, Kitchen Timer or the interior oven lights.

#### To activate the Oven Lockout feature

1. Press and hold the  for 3 seconds.
2. Allow 20 seconds for the door to lock. The  icon will flash while the door is locking and stay on once the door is locked.

#### To deactivate the Oven Lockout feature:

1. Press and hold the  for 3 seconds.
2. The  icon will flash while the door is unlocking. Allow 20 seconds for the door to unlock.  
After 20 seconds the  icon will disappear in the display.

## Setting Oven Controls

### Setting Bake

The oven can be set to bake at any temperature from 170° F to 550° F (The sample shown is for 350° F).

Note that the convection fan will operate while the oven pre-heats.

#### To set the Bake Temperature to 350° F

1. Arrange interior oven racks, place food in oven and close oven door.
2. Turn the selector control knob to Bake (Figure 1).
3. Turn the temperature control knob to 350 (Figure 2).

The temperature will appear briefly in the oven control display. The display will beep indicating that the temperature is set. Then the temperature will disappear from the display.

4. When baking is completed, turn the temperature and the selector control knobs to Off position.

**NOTE** : The temperature knob can be used to modify the baking temperature while the oven is in bake mode, but the function knob **cannot** be changed to another function without turning it to Off first. An **ERR** code will appear in the display if another function is selected without turning to Off.

**NOTE** : The control will beep three times if the mode and temperature **do not** match. The control will beep only once if the mode and temperature **do** match.

Ex: Bread Proof with temperature at 500° F (not possible, 3 beeps).

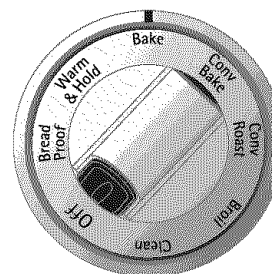

Figure 1

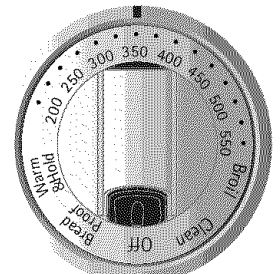

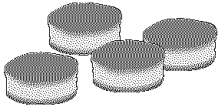
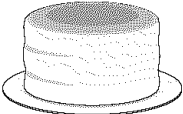

Figure 2

# Setting Oven Controls

## Oven Baking

For best cooking results, pre-heat the oven before baking cookies, breads, cakes, pies or pastries, etc.

The cooking times and temperatures needed to bake a product may vary slightly from your previously owned appliance. If you feel your oven is too hot or too cold, you can adjust its temperature. Refer to the "Adjusting oven temperature" section.

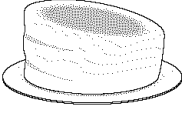
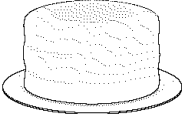
Baking Problems and Solutions Chart		
Baking Problems	Causes	Corrections
<p><b>Cookies and biscuits burn on the bottom.</b></p> 	<ul style="list-style-type: none"> <li>• Cookies and biscuits put into the oven before the preheating time is completed.</li> <li>• Oven rack overcrowded.</li> <li>• Dark pan absorbs heat too fast.</li> </ul>	<ul style="list-style-type: none"> <li>• Allow oven to preheat to the selected temperature before placing food in oven.</li> <li>• Choose pan sizes that will permit 2" to 4" (5.1 cm to 10.2 cm) of air space on all sides when placed in the oven.</li> <li>• Use a medium-weight aluminum baking sheet.</li> </ul>
<p><b>Cakes too dark on top or bottom.</b></p> 	<ul style="list-style-type: none"> <li>• Cakes put into the oven before preheating time is completed.</li> <li>• Rack position too high or low.</li> <li>• Oven too hot.</li> </ul>	<ul style="list-style-type: none"> <li>• Allow oven to preheat to the selected temperature before placing food in the oven.</li> <li>• Use proper rack position for baking needs.</li> <li>• Set oven temperature 25°F lower than recommended.</li> </ul>
<p><b>Cakes not done in the center.</b></p> 	<ul style="list-style-type: none"> <li>• Oven too hot.</li> <li>• Incorrect pan size.</li> <li>• Pan not centered in oven.</li> </ul>	<ul style="list-style-type: none"> <li>• Set oven temperature 25°F lower than recommended.</li> <li>• Use pan size suggested in recipe.</li> <li>• Use proper rack position and place pan so there is 2" to 4" (5.1 cm to 10.2 cm) of space on all sides of pan.</li> </ul>
<p><b>Cakes not level.</b></p> 	<ul style="list-style-type: none"> <li>• Range not level.</li> <li>• Pan too close to oven wall or rack overcrowded.</li> <li>• Pan warped.</li> </ul>	<ul style="list-style-type: none"> <li>• Place a marked glass measuring cup filled with water on the center of the oven rack. If the water level is uneven, refer to the installation instructions for leveling the appliance.</li> <li>• Be sure to allow 2" to 4" (5.1 cm to 10.2 cm) of clearance on all sides of each pan in the oven.</li> <li>• Do not use pans that are dented or warped.</li> </ul>
<p><b>Foods not done when cooking time is up.</b></p> 	<ul style="list-style-type: none"> <li>• Oven too cool.</li> <li>• Oven overcrowded.</li> <li>• Oven door opened too frequently.</li> </ul>	<ul style="list-style-type: none"> <li>• Set oven temperature 25°F higher than suggested and bake for the recommended time.</li> <li>• Be sure to remove all pans from the oven except the ones to be used for baking.</li> <li>• Open oven door only after shortest recommended baking time.</li> </ul>

# Setting Oven Controls

## Setting Convection Bake

Use the Convection Bake feature when fast cooking is desired. The oven can be programmed for Convection baking at any temperature between 170°F and 550°F. Convection baking uses a fan to circulate the oven's heat evenly and continuously within the oven (See Figure 1). This improved heat distribution allows for fast, even cooking and browning results at a lower temperature than conventional bake. It also gives better baking results when using 2 or 3 racks at the same time. Breads and pastries brown more evenly. Convection bake cooks most foods faster and more evenly than conventional bake.

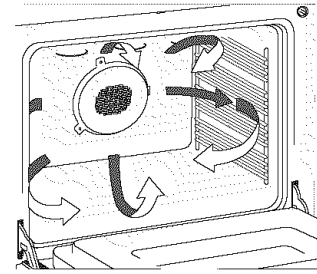

Air circulation during Convection Bake

Figure 1

### General Convection Bake Instructions

1. Adjust the cook time for desired doneness as needed. Time reductions will vary depending on the amount and type of food to be cooked. Cookies and biscuits should be baked on pans with no sides or very low sides to allow heated air to circulate around the food. Food baked on pans with a dark finish will cook faster.
2. Preheating is not necessary when cooking casseroles with Convection Bake.
3. When using Convection Bake with a single rack, place oven rack in position 8. If cooking on multiple racks, place the oven racks in positions 3 and 12 (see page 7).

### To set the oven to Convection Bake at 350°F

1. Arrange interior oven racks, place food in oven and close oven door.
2. Turn the selector control knob to Conv Bake (Figure 2). The convection fan will start.
3. Turn the temperature control knob to 350 (Figure 3). The temperature will appear briefly in the oven control display. The display will beep indicating that the temperature is set. Then the temperature will disappear from the display.
4. When baking is completed, turn the temperature and the selector control knobs to Off position.

### Benefits of Convection Bake:

- Some foods cook up to 30% faster, saving time and energy.
- Multiple rack baking.
- No special pans or bakeware needed.

ENGLISH

## Setting Convection Roast

This method of cooking enables you to obtain the best results when roasting. The oven can be programmed to convection roast at any temperature from 170°F to 550°F. Remember to use tested recipes with times adjusted for convection roasting when using the convection mode. Times may be reduced by as much as 30% when using the convection feature.

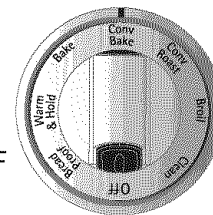

Figure 2

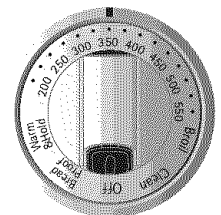

Figure 3

### To Set the oven to Convection Roast at 350°F

1. Arrange interior oven racks, place food in oven and close oven door.
2. Turn the selector control knob to Conv Roast (Figure 4). The convection fan will start.
3. Turn the temperature control knob to 350 (Figure 5). The temperature will appear briefly in the oven control display. The display will beep indicating that the temperature is set. Then the temperature will disappear from the display.
4. When baking is completed, turn the temperature and the selector control knobs to Off position.

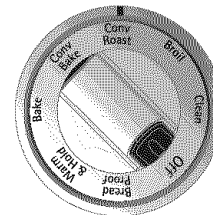

Figure 4

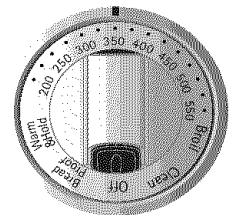



Figure 5

## Setting Convection Convert

The appliance is equipped with a feature which will allow you to change from a normal baking recipe temperature to a convection baking temperature without making any manual temperature adjustment; the controller will do it automatically.

The  pad controls the convection convert feature.

### To change from a normal bake recipe to a convection bake recipe

When the convection bake mode is on, press . This function will lower the oven temperature by 25°F less than the control setting. When convection baking is completed turn the temperature and the selector control knobs to Off position.

**Note:** The oven temperature indicator will show a temperature 25°F lower than temperature control knob setting.

# Setting Oven Controls

## Using the Temperature Probe Feature

For many foods, especially roasts and poultry, testing the internal temperature is the best method to insure properly cooked food. The Temperature Probe gets the exact temperature you desire without having to guess.

### IMPORTANT:

1. Use only the probe supplied with your appliance; any other may result in damage to the probe or the appliance.
2. Handle the Temperature Probe carefully when inserting and removing it from the food and outlet.
3. Do not use tongs to pull the cable when inserting or removing the Probe. It could damage the Probe.
4. Defrost your food completely before inserting the Probe to avoid breaking it.
5. Never leave or store the Temperature Probe inside the oven when not in use.
6. To prevent the possibility of burns, carefully unplug the Temperature Probe using hot pads.

### Proper Temperature Probe Placement:

1. Always insert the probe so that the tip rests in the center of the thickest part of the meat. Do not allow probe to touch bone, fat, gristle or pan.
2. For bone-in ham or lamb, insert the Probe into the center of the lowest large muscle or joint. For dishes such as meat loaf or casseroles, insert the Probe into the center of the food. When cooking fish, insert the Probe from just above the gill into the meatiest area, parallel to the backbone.
3. For whole poultry (chicken, turkey, etc.), insert the probe into the thickest part of the inner thigh from below and parallel to the leg (see figure 1).

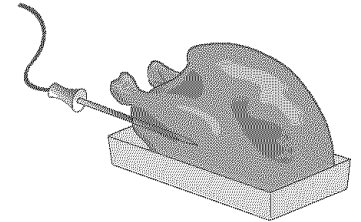





Figure 1

### Setting the Oven When using the Temperature Probe:

1. Preheat the oven to the desired temperature.
2. Insert the Temperature Probe into the food (see Proper Temperature Probe Placement above).
3. After the oven has reached the desired temperature, place the food into the oven.
4. The oven will be hot, so wear an oven mitt and plug the Temperature Probe into its outlet in the oven. (The outlet is located on the left front side of the oven cavity ceiling). Make sure it is pushed all the way into the outlet. Close the oven door.
5. The oven control will detect if the probe is correctly plugged in and will illuminate PROBE in the display. The display will start showing the actual meat temperature shortly after the probe is inserted.
6. A target temperature must be set to trigger the buzzer when the food is done cooking. Press the  button to enter the temperature. Adjust temperature to the desired setting using the  or  buttons. The temperature setting will be accepted 5-8 seconds after it is entered.
7. At any time during the cooking, the  button can be pressed to change the display between "ACTUAL" and "PROBE". The "ACTUAL" setting will give you the current temperature of the food. The "PROBE" setting will give you the food target temperature and it can be changed at any time during the cooking (see above for explanations).

**IMPORTANT:** The probe can be damaged by very high temperature. To protect the probe against this damage, the oven control will not allow you to start a self-clean or set a temperature higher than 450°F while the probe is connected.

## Setting the Bread Proof Feature

To enable the Bread Proof function, both controls need to be turned to the Bread Proof option, as illustrated below.

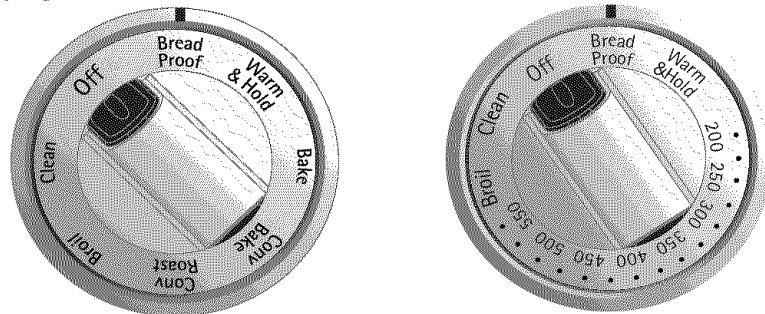

## Preparing Bread Dough In The Oven

The oven has a Bread Proof feature that can be used to help prepare bread dough. The recommended length of time to keep bread dough in the oven is about 45-60 minutes. Be sure however to follow the recipe's recommended times. The prepared bread dough should be placed in a large bowl since the dough will nearly double in volume. Arrange the oven rack in the lowest position. Place the bowl on the rack in the oven and follow the Bread Proof Control setting instructions as illustrated.

# Setting Oven Controls

## Setting the Warm & Hold™ Feature

The Warm & Hold feature will maintain an oven temperature of 170°F, and will keep oven baked foods warm for serving for 3 hours after cooking has finished. The Warm & Hold feature may be used without any other cooking operations or can be used after cooking has finished.

### To set Warm & Hold

1. Arrange interior oven racks and place food in oven.
2. Turn both the selector and the temperature control knobs to Warm Hold position.
3. To turn the Warm & Hold OFF at any time, turn the temperature and the selector control knobs to Off position.

## Setting Broil

When broiling, heat radiates downward from the oven broiler for even coverage. The Broil feature is preset to start broiling at 550°F; however, the Broil feature temperature may be set between 400°F and 550°F. This appliance includes a Searing Grill for searing meats (Figure 3). The broil pan and broil pan insert used together allow dripping grease to drain and be kept away from the high heat of the oven broiler. **DO NOT** use the broil pan without the insert (See Figure 1). **DO NOT cover the broil pan insert with foil.** The exposed grease could catch fire.

**⚠ WARNING** Should an oven fire occur, leave the oven door closed and turn off the oven. If the fire continues, throw baking soda on the fire or use a fire extinguisher. **DO NOT** put water or flour on the fire. Flour may be explosive and water can cause a grease fire to spread and cause personal injury.

### To set the oven to broil

1. Place the broiler pan insert on the broiler pan (Figure 1). Then place the food on the broiler pan insert. **DO NOT** use the broiler pan without the insert. **DO NOT** cover the broiler insert with foil. The exposed grease could ignite.
2. Arrange the interior oven rack and place the broiler pan on the rack. Be sure to center the broiler pan directly under the broiler element. **Make sure the oven door is in the broil stop position (See Figure 2).**
3. Turn both the selector and the temperature control knobs to the Broil position.
4. If a lower broil temperature is desired (minimum allowed broil temperature is 400°F), turn the temperature control knob to the temperature desired.
5. Broil on one side until food is browned; turn and cook on the second side. Season and serve. **Note:** Always pull the rack out to the stop position before turning or removing food.
7. To cancel broiling or if finished broiling, turn the selector and the temperature control knobs to Off position.

### Broiling Times and Searing Grill

Use the following table for approximate broiling times. Increase or decrease broiling times, or move the broiling pan to a different rack position to suit for doneness. If the food you are broiling is not listed in the table, follow the instructions provided in your cookbook and watch the item closely. Use the Searing Grill for meats and steaks if desired. Place Searing Grill on top of Broiler Pan and Insert before placing the meat. Be sure to pre-heat the Searing Grill using Broil for 10 minutes. Cook times should be reduced 1-2 minutes per side when cooking with the Searing Grill for meats and steaks (See Figure 3).

**NOTE:** When in broiling mode, the high speed cooling fan will be in operation and may continue for some minutes after broiling is finished.

### Electric Range Broiling Table Recommendations

Food Item	Rack Position	Temp Setting	Cook Time		Doneness
			1st side	2nd side	
Steak 1" thick	12	550° F	6:00	4:00	Rare
	12	550° F	7:00	5:00	Medium
Pork Chops 3/4" thick	12	550° F	8:00	6:00	Well
Chicken - Bone In	11	450° F	20:00	10:00	Well
Chicken - Boneless	12	450° F	8:00	6:00	Well
Fish	12	500° F	13:00	n/a	Well
Shrimp	11	550° F	5:00	n/a	Well
Hamburger 1" thick	12	550° F	9:00	7:00	Medium
	11	550° F	10:00	8:00	Well

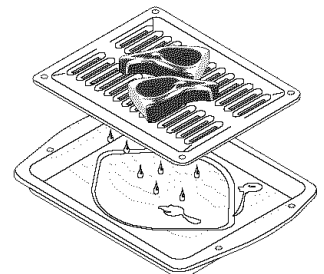
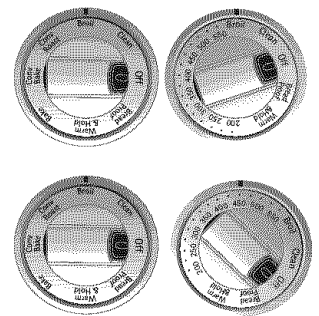
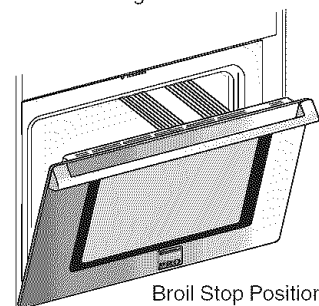
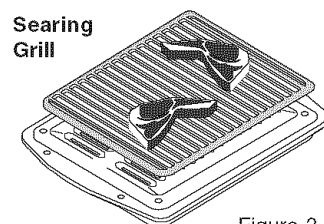

Figure 1



Broil Stop Position  
Figure 2



Searing Grill  
Broil Pan & insert  
Figure 3

ENGLISH

# Self-Cleaning

**⚠ CAUTION** During the self-cleaning cycle, the outside of the wall oven can become very hot to the touch. **DO NOT** leave small children unattended near the appliance.

**⚠ CAUTION** The health of some birds is extremely sensitive to the fumes given off during the self-clean cycle of any wall oven. Move birds to another well ventilated room.

**⚠ CAUTION** **DO NOT** line the oven walls, racks, bottom or any other part of the appliance with aluminum foil. Doing so will destroy heat distribution, produce poor baking results and cause permanent damage to the interior (aluminum foil will melt to the interior surface of the oven).

**⚠ CAUTION** **DO NOT** force the oven door open. This can damage the automatic door locking system. Use caution when opening the door after the Self-Cleaning cycle is completed. The oven may still be **VERY HOT**.

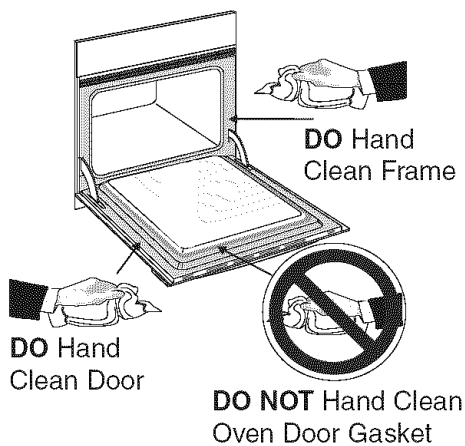

Note: See additional cleaning information for the oven door in the **General Care & Cleaning** section.

## Self-Cleaning Oven

A Self-Cleaning oven cleans itself with high temperatures (well above cooking temperatures) which eliminate soils completely or reduces them to a fine powdered ash you can wipe away with a damp cloth.

### Adhere to the following cleaning precautions:

- Allow the oven to cool before cleaning.
- Wear rubber gloves when cleaning any exterior parts of the oven manually.
- **DO NOT** clean the oven door gasket. The woven material of the oven door gasket is essential for a good seal. Care should be taken not to rub, damage or remove the gasket.
- **DO NOT** use any cleaning materials on the oven door gasket. Doing so could cause damage.
- **Remove the ladder racks, oven racks and meat probe. These items will be permanently damaged by the high cleaning temperatures.**
- **Remove any excessive spillovers** in the oven cavity **before** starting the Self-Cleaning cycle. To clean, use hot, soapy water and a cloth. Large spillovers can cause heavy smoke or fire when subjected to high temperatures. **DO NOT** allow food spills with a high sugar or acid content (such as milk, tomatoes, sauerkraut, fruit juices or pie filling) to remain on the surface as they may leave a dull spot even after cleaning.
- Clean any soil from the oven frame, the door liner outside the oven door gasket and the small area at the front center of the oven bottom. These areas do not heat sufficiently to burn soil on. Clean with soap and water.

NOTE: Prior to setting the Self-Clean cycle, any spills remaining on the oven bottom should be removed.

**⚠ CAUTION** The oven broil element may appear to have cooled after it has been turned OFF. **The element may still be hot** and burns may occur if this element is touched before it has cooled sufficiently.

## What to Expect during Cleaning

While the oven is in operation, the oven heats to temperatures much higher than those used in normal cooking. Sounds of metal expansion and contraction are normal. Odor is also normal as the food soil is being removed. Smoke may appear through the oven vent.

If heavy spillovers are not wiped up before cleaning, they may flame and cause more smoke and odor than usual. This is normal and safe and should not cause alarm. If available, use an exhaust fan during the self-cleaning cycle.

NOTE : While the wall oven is in self-clean, the cooling fans will be in operation in both ovens even if only one oven is in cleaning mode. This is used to cool down the electronic components of the unit.

## Self-Cleaning

### Self-Clean Cycle Time Length

If you are planning to use the oven directly after a self-clean cycle remember to allow time for the oven to cool down and the oven door to unlock. This normally takes about 1½ hour. So a self-clean cycle (3 hours) will actually take about 4½ hours to complete. The time remaining for the self-clean cycle will be displayed in the oven control display.

### To set the controls for a Self-Cleaning cycle

1. Be sure the oven door is closed.
2. Turn both the selector and the temperature control knobs to Clean position.
3. As soon as the control is set, the motor driven oven door lock will begin to close automatically. While the door is locking, the  icon will flash and then will remain visible for the entire self-clean cycle.

**Note:** Allow about 20 seconds for the oven door lock to close.

### When the Self-Clean Cycle is Completed

1. Turn the selector and the temperature control knobs back to Off position.
2. Once the oven has cooled down for approximately 1½ HOUR, the oven door can then be opened. While the door is unlocking, the  icon will flash and then will disappear from the oven control display.

### Stopping or Interrupting a Self-Cleaning Cycle



If it becomes necessary to stop or interrupt a self-cleaning cycle due to excessive smoke or fire in the oven:

1. Turn the selector and the temperature control knobs to Off position.
2. The oven door can only be opened after the oven has cooled down for approximately 1½ HOUR.

## Adjusting Oven Temperature

The temperature in the oven has been pre-set at the factory. When first using the oven, be sure to follow recipe times and temperatures. If you think the oven is cooking too hot or too cool for the temperature you select, you can adjust the actual oven temperature to be more or less than what is displayed. Before adjusting, test a recipe by using a temperature setting that is higher or lower than the recommended temperature. The baking results should help you to decide how much of an adjustment is needed.

### To adjust the oven temperature

1. Press and hold the  button until "00" appears in the oven control display.
2. To increase the temperature use the  button to enter the desired change; and to decrease the temperature use the  button (a minus sign will appear in the display indicating the temperature is decreased).
3. Wait 5 seconds for the change to be accepted by the oven control.

**Note:** The oven temperature adjustments made with this feature will not change the Self-Clean or Broil temperature. Once the temperature has been changed, the temperature indicator will still display the value set from the temperature knob but the actual temperature in the oven will be higher or lower.

**CAUTION** To avoid possible burns use care when opening the oven door after the Self-Cleaning cycle. Stand to the side of the oven when opening the door to allow hot air or steam to escape.

**CAUTION DO NOT** force the oven door open. This can damage the automatic door locking system. Use caution and avoid possible burns when opening the door after the Self-Cleaning cycle has completed. The oven may still be VERY HOT.

# General Care & Cleaning

## Cleaning Various Parts of Your Oven

Before cleaning any part of the oven, be sure all controls are turned OFF and the oven is COOL. REMOVE SPILLOVERS AND HEAVY SOILING AS SOON AS POSSIBLE. REGULAR CLEANINGS NOW WILL REDUCE THE EXTENT AND DIFFICULTY OF MAJOR CLEANING LATER.

Surfaces	How to Clean
Aluminum (Trim Pieces) & Vinyl	Use hot, soapy water and a cloth. Dry with a clean cloth. Do not scour or use all-purpose cleaners, ammonia, powdered cleaners or commercial oven cleaner. They can scratch and discolor aluminum.
Painted and Plastic, Control Panel, Body Parts, and Decorative Trim	<p><i>For general cleaning</i>, use hot, soapy water and a cloth. <i>For more difficult soils and built-up grease</i>, apply a liquid detergent directly onto the soil. Leave on soil for 30 to 60 minutes. Rinse with a damp cloth and dry. <b>DO NOT</b> use abrasive cleaners on any of these materials; they can scratch.</p> <p>To remove control knobs, turn to the OFF position; grasp firmly and pull straight off the shaft. To replace knobs after cleaning, line up the flat sides of both the knob and the shaft; then push the knob into place.</p>
Stainless Steel, Chrome, Control Panel, Decorative Trim	<p><i>Before cleaning the control panel</i>, turn all controls to OFF and remove the control knobs. To remove, pull each knob straight off the shaft. Clean using hot, soapy water and a dishcloth. Rinse with a clean water using a dishcloth. Be sure to squeeze excess water from the cloth before wiping the panel; especially when wiping around the controls. Excess water in or around the controls may cause damage to the appliance. To replace knobs after cleaning, line up the flat sides of both the knob and the shaft; then push the knob into place.</p> <p>Clean <b>stainless steel</b> with hot, soapy water and a dishcloth. Rinse with clean water and a cloth. <b>Do not use cleaners with high concentrations of chlorides or chlorines.</b> Always clean on the same direction as the stainless steel grain. Do not use harsh scrubbing cleaners. Only use kitchen cleaners that are especially made for cleaning stainless steel. Always be sure to rinse the cleaners from the surface as bluish stains may occur during heating that cannot be removed.</p>
Porcelain Enamel, Broiler Pan and Insert, Door Liner, Body Parts	Gentle scouring with a soapy scouring pad will remove most spots. Rinse with a 1:1 solution of clear water and ammonia. <i>If necessary</i> , cover difficult spots with an ammonia-soaked paper towel for 30 to 40 minutes. Rinse with clean water and a damp cloth, and then scrub with a soap-filled scouring pad. Rinse and wipe dry with a clean cloth. Remove all cleaners or the porcelain may become damaged during future heating. <b>DO NOT</b> use spray oven cleaners on the cooktop.

### Oven Racks

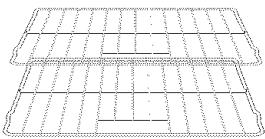

**CAUTION** Oven racks, oven rack ladders and meat probe must be removed from the oven during the self-clean cycle for cleaning. If they are not removed, the self-clean cycle will damage the racks permanently, causing them to discolor and making them difficult to slide. If this occurs, coat the racks with cooking oil to make them easier to slide again.

### Oven Door

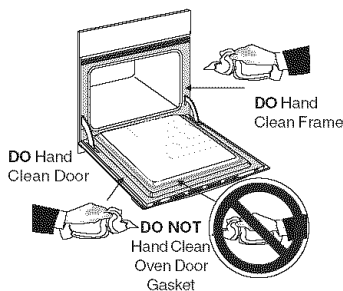

Use soap & water to thoroughly clean the top, sides and front of the oven door. Rinse well. You may use a glass cleaner on the outside glass of the oven door. **DO NOT** immerse the door in water. **DO NOT spray or allow water or the glass cleaner to enter the door vents.** **DO NOT** use oven cleaners, cleaning powders or any harsh abrasive cleaning materials on the outside of the oven door.

**DO NOT** clean the oven door gasket. The oven door gasket is made of a woven material, which is essential for a good seal. Care should be taken not to rub, damage or remove this gasket.

# General Care & Cleaning

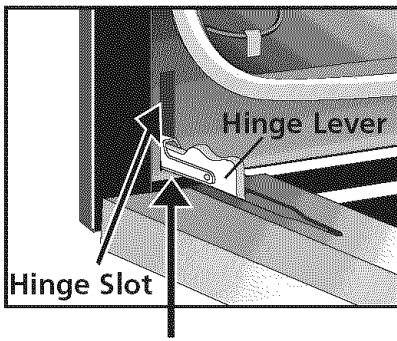

Lock in normal position  
Figure 1

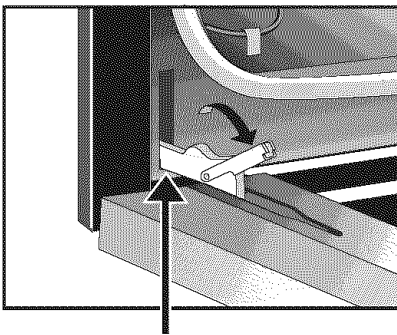

Lock engaged for door removal  
Figure 2

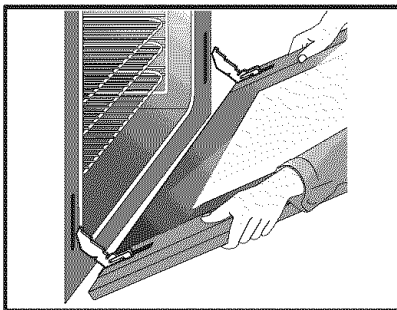

Door removed from the oven  
Figure 3

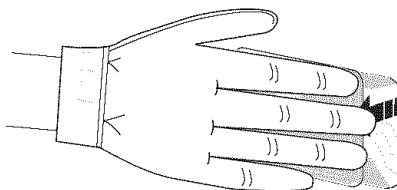

Lift up and pull out.

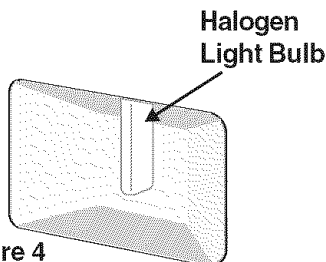

Figure 4

## Care and Cleaning of Stainless Steel

This model is equipped with stainless steel exterior parts. Special care and cleaning are **required** for maintaining the appearance of stainless parts. Please refer to the table provided at the beginning of the **General Care & Cleaning** section in this Use & Care Guide.

## Removing and Replacing the Oven Door

**CAUTION** The door is heavy. For safe, temporary storage, lay the door flat with the inside of the door facing down.

### To Remove Oven Door:

1. Open the door to the fully opened position.
2. Pull up the lock located on both hinge levers to door removal position (Figure 2).
3. Grab the door by the sides and pull the bottom of the door up and toward you to disengage the hinge levers from the hinge slots. Keep pulling the bottom of the door toward you while rotating the top of the door toward the range to completely disengage the hinge levers (Figure 3).
4. To clean oven door, follow the instructions provided in the **General Care & Cleaning** table.

### To Replace Oven Door:

1. Grab the door by the sides; place the hinge levers into the hinge slots. Open the door to the fully opened position.
2. Engage the lock on both hinge levers to normal position (Figure 1).  
Note: Make sure the hinge levers are fully inserted into hinge slots before locking them.
3. Close the oven door.

## Special Door Care Instructions

Oven doors contain glass that can break.

Read the following recommendations:

1. Do not close the oven door until all the oven racks are fully in place.
2. Do not hit the glass with pots, pans, or any other object.
3. Scratching, hitting, jarring or stressing the glass may weaken its structure causing an increased risk of breakage at a later time.

## Changing the Oven Light

### Changing the Oven Light

The oven lights will automatically turn ON when the oven door is opened. The oven lights may also be manually operated by pressing the  pad.

The oven light bulb is covered with a glass shield. The glass shield can be removed to be cleaned manually or to change oven light. **THIS GLASS SHIELD MUST BE IN PLACE WHENEVER THE OVEN IS IN USE.**

### To replace the light bulb:

**CAUTION: BE SURE THE OVEN IS COOL.**

1. Turn the power off at the main source.
2. Wear a leather-faced glove for protection against possible broken glass.
3. To remove the glass shield, lift up on side with gloved finger and use force to pull shield out.
4. Replace halogen light appliance bulb taking care not to touch the bulb with your bare fingers. Touching bulb with your skin can leave a film on the bulb that causes it to burn out quickly.
5. Replace glass shield in opposite order and manner of removal.

# Before You Call

## Solutions to Common Problems

*Before you call for service*, review this list. It may save you time and expense. The list includes common occurrences that are not the result of defective workmanship or materials in this appliance.

OCCURRENCE	POSSIBLE CAUSE/SOLUTION
Oven Control Beeps and Displays any F code error (example F11).	Electronic control has detected a fault condition. Press <b>any key</b> to clear the display and stop the beeping. Reprogram the oven. If a fault reoccurs, record the fault number. Press <b>any key</b> and call Sears or another qualified servicer.
“d-o” is displayed.	The door was left open and controls set for self-cleaning cycle. Just close the door to correct the problem.
Appliance not level. Poor cooking results.	Place oven rack in center of oven. Place a level on the oven rack. Contact installing agent if rack and cabinet cutout flooring are not level.  Kitchen cabinet misalignment may make oven appear to be not level. Be sure cabinets are square and level. Contact cabinet maker to correct problem.
Entire oven does not operate.	When the oven is first plugged in, or when the power supply to the oven has been interrupted, the display will flash. The oven cannot be programmed until the clock is set.  Be sure electrical cord is securely connected into the electrical junction box.  Cord/plug is not installed and/or connected. Cord is not supplied with oven. Contact Sears or another qualified servicer.  Service wiring not complete. Contact Sears or another qualified servicer.  Power outage. Check house lights to be sure. Call your local electric company.  Short in cord/plug. Replace cord/plug.  Controls are not set properly. See instructions under <b>Setting Oven Controls</b> to set the controls.  House fuse has blown or circuit breaker has tripped immediately following installation. House fuse may not be fully engaged. Check fuse and screw or engage circuit breaker securely.  House fuse has blown or circuit breaker has tripped after the oven has been installed and previously operating. Contact Sears or another qualified servicer.
Oven light does not work.	Burned-out or loose bulb. Follow the instructions under <b>Changing Oven Light</b> to replace or tighten the bulb.
Fan noise during cooking operation.	A cooling fan may automatically turn on and off to cool internal parts. This is normal, and the fan may continue to run even after oven is turned off.

# Before You Call

## Solutions to Common Problems

OCCURRENCE	POSSIBLE CAUSE / SOLUTION
<b>Oven smokes excessively during broiling.</b>	Oven door is closed. Door should be open during broiling.
	Meat too close to the broiler unit. Reposition the rack to provide more clearance between the meat and the broiler. Preheat broil element for quick searing operation.
	Meat not properly prepared. Remove excess fat from meat. Slash remaining fatty edges to prevent curling, but do not cut into the lean.
	Grid on broiler pan wrong-side up. Grease does not drain into broiler pan. Always place the grid on the broiler pan with the ribs up and the slots down to allow grease to drip into the pan.
	Broiler pan used without grid or grid cover with foil. <b>DO NOT</b> use the broiler pan without the grid or cover the grid with foil.
	Oven needs to be cleaned. Grease has built up on oven surfaces. Regular cleaning is necessary when broiling frequently. Old grease or food spatters cause excessive smoking.
<b>Poor baking results.</b>	Many factors affect baking results. See <b>Oven Baking</b> for hints, causes and corrections. See <b>Adjusting Oven Temperature</b> .
<b>Self-cleaning cycle does not work.</b>	Make sure the oven door is closed.
	Controls not set properly. Follow instructions.
	Self-cleaning cycle was interrupted. Follow steps under "Stopping or Interrupting a Self-Cleaning Cycle" in the Use & care Guide.
<b>Soil not completely removed after self-cleaning cycle is completed.</b>	Failure to hand clean oven frame and door liner outside the oven door gasket before starting the self-clean cycle. Hand clean burned on residue with a stiff nylon brush and water or a nylon scrubber. Do not clean the oven door gasket or it will be damaged.
<b>Flames inside oven or smoke from vent.</b>	Excessive spillovers in oven. This is normal, especially for high oven temperatures, pie spillovers or for large amounts of grease on bottom of oven. Wipe up excessive spillovers.

**Notes :**

Notes :

# Get it fixed, at your home or ours!

## Your Home

For repair – **in your home** – of **all** major brand appliances, lawn and garden equipment, or heating and cooling systems, **no matter who made it, no matter who sold it!**

For the replacement parts, accessories and owner's manuals that you need to do-it-yourself.

For Sears professional installation of home appliances and items like garage door openers and water heaters.

**1-800-4-MY-HOME<sup>®</sup>** (1-800-469-4663)

Call anytime, day or night (U.S.A. and Canada)

[www.sears.com](http://www.sears.com)    [www.sears.ca](http://www.sears.ca)

## Our Home

For repair of carry-in items like vacuums, lawn equipment, and electronics, call or go on-line for the location of your nearest **Sears Parts & Repair Service Center.**

**1-800-488-1222**

Call anytime, day or night (U.S.A. only)

[www.sears.com](http://www.sears.com)

To purchase a protection agreement (U.S.A.) or maintenance agreement (Canada) on a product serviced by Sears:

**1-800-827-6655** (U.S.A.)

**1-800-361-6665** (Canada)

Para pedir servicio de reparación a domicilio, y para ordenar piezas:

**1-888-SU-HOGAR<sup>®</sup>**

(1-888-784-6427)

Au Canada pour service en français:

**1-800-LE-FOYER<sup>MC</sup>**

(1-800-533-6937)

[www.sears.ca](http://www.sears.ca)

The Sears logo is displayed in a large, bold, black serif font. The word "Sears" is written in a classic, slightly stylized font. Below the word, there is a horizontal line that is thicker in the middle and tapers off at the ends, resembling a swoosh or a stylized underline.

® Registered Trademark / <sup>TM</sup> Trademark / <sup>SM</sup> Service Mark of Sears Brands, LLC

® Marca Registrada / <sup>TM</sup> Marca de Fábrica / <sup>SM</sup> Marca de Servicio de Sears Brands, LLC

<sup>MC</sup> Marque de commerce / <sup>MD</sup> Marque déposée de Sears Brands, LLC

© Sears Brands, LLC